

Bremshydraulik Hydraulic Components



2025

Bremsen-Ersatzteilprogramm
Brake Parts Program



Brakethrough Technology



Erstklassig First-class

Besser ist besser

Wenn es um Qualität geht, genügt uns ein „sehr gut“ noch lange nicht. Wir erfüllen hohe Ansprüche an das Qualitätsmanagement und die europäische Sicherheitsnorm ECE-R90 wird von ATE sogar übertroffen. Zudem führen wir zahlreiche zusätzliche Tests durch, unter anderem zu Verschleiß und Wärmeleistung.

Auch Nachhaltigkeit ist uns wichtig: Wir stellen die Mischungen für ATE Bremsbeläge auf kupferfreie Materialien um und setzen bei ATE Ceramic auf geringen Abrieb. Nutzen ausschließlich umweltfreundliches Material für die Beschichtung von Bremscheiben. Und bereiten Produkte wie Bremsattel wieder auf.

Better is better

When it comes to quality, “very good” is simply not good enough for us. We meet high standards of quality management – and ATE even exceeds the European safety standard ECE-R90. We also perform many additional tests, including wear and thermal performance.

Sustainability is also important to us: we convert the compounds for ATE brake pads to copperfree materials and opt for low abrasion with ATE Ceramic. We only use environmentally friendly material for the coating of brake discs – and we remanufacture products like brake callipers.

Höchste Qualität für optimale Leistung.

Große Auswahl für alle Einsatzgebiete

ATE SecuBrake

ist die zukunftsweisende Bremsflüssigkeit, die Nachhaltigkeit und Arbeitssicherheit vereint. Erstmals werden die gesetzlichen Anforderungen an eine DOT 4-Bremsflüssigkeit ohne Borsäureester erfüllt – bei gleichzeitiger Herstellung in einem zertifizierten Produktionsprozess mit nachwachsenden Rohstoffen.

ATE SUPER DOT 5.1

bietet beste Funktionalität bei heißen wie kalten Einsatzbedingungen: höchster Nass-Siedepunkt bei niedriger Viskosität. Erfüllt somit aktuell die höchsten Anforderungen der Fahrzeughersteller. Daher ideal für Fahrzeuge mit modernen Fahrerassistenzsystemen wie ESP, ABS und ASR.



- | ATE SL als bewährter DOT 4-Typ, ATE TYP 200 für Rennsportbegeisterte und ATE DOT 3 Blau für Oldtimer und Fahrzeuge, wo die Verwendung einer DOT 3-Flüssigkeit vom Fahrzeughersteller vorgeschrieben ist
- | ATE SL.6 ist optimal für ESP, ABS und ASR: dünnflüssig auch bei niedrigen Temperaturen, schnelle Reaktionszeit
- | Siedepunkte und Viskosität übertreffen gesetzliche und technische Anforderungen
- | Schutz vor Korrosion durch hochwertige Additive

BENEFITS

In unserem Expert Talk stellen wir Ihnen die verschiedenen Bremsflüssigkeiten vor:



Die Eigenschaften von ATE Bremsflüssigkeiten

	Siedepunkt	Nass-Siedepunkt	Viskosität bei -40 °C
ATE SecuBrake	min. 260 °C	min. 155 °C	max. 700 mm ² /s
ATE SUPER DOT 5.1	min. 265 °C	min. 180 °C	max. 700 mm ² /s
ATE TYP 200 DOT 4 Racing-Qualität	min. 280 °C	min. 198 °C	max. 1.400 mm ² /s
ATE SL.6 DOT 4 Ideal für ESP, ABS, ASR	min. 265 °C	min. 175 °C	max. 700 mm ² /s
ATE SL DOT 4	min. 260 °C	min. 165 °C	max. 1.400 mm ² /s
ATE DOT 3 Blau	min. 245 °C	min. 150 °C	max. 1.500 mm ² /s

Nur Bremsflüssigkeit gemäß Fahrzeugherstellerangaben verwenden! Zur Erhaltung der Funktionssicherheit der Bremsanlage muss die Bremsflüssigkeit entsprechend den vom Fahrzeughersteller vorgegebenen Wechselintervallen erneuert werden.

ATE Servicegeräte erleichtern die Arbeit.

Natürlich bieten wir auch Geräte für Tests, Entlüftung und Entsorgung von Bremsflüssigkeiten an. Sie arbeiten exakt und zuverlässig, sind leicht zu bedienen und technologisch auf dem neuesten Stand.

INFORMATIONEN

Erfahren Sie mehr über ATE Bremsflüssigkeiten auf www.ate.de/bremsfluessigkeiten sowie über unsere Servicegeräte auf www.ate-info.de



Typ	ATE Sachnummer	EAN-Nr. 4006633	Gebinde	Paletteneinheit	
SECU BRAKE	SAE-Spezifikation, J1704-FMVSS 116/DOT 4 ISO 4925, Klasse 4 – niedrigviskos	706803 03.9901-6803.2	50307 5	5 l	144 Kannen ³
		706811 03.9901-6811.2	50309 9	20 l	36 Kannen
SUPER DOT 5.1	SAE-Spezifikation, J1704-FMVSS 116/DOT 5.1 ISO 4925, Klasse 7 – niedrigviskos	706602 03.9901-6602.2	45757 6	1 l	600 Kannen ²
		706603 03.9901-6603.2	45759 0	5 l	144 Kannen ³
		706611 03.9901-6611.2	45761 3	20 l	36 Kannen
		706620 03.9901-6620.2	48735 1	30 l	22 Kannen
		706614 03.9901-6614.2	48734 4	50 l	6 Kannen
TYP 200	SAE-Spezifikation, J1704-FMVSS 116/DOT 4 ISO 4925, Klasse 4	706202 03.9901-6202.2	10825 6	1 l	600 Kannen ²
		706203 03.9901-6203.2	12166 8	5 l	144 Kannen ³
		706220 03.9901-6220.2	12780 6	30 l	22 Kannen
SL 6	SAE-Spezifikation, J1704-FMVSS 116/DOT 4 ISO 4925, Klasse 6 – niedrigviskos	706402 03.9901-6402.2	20746 1	1 l	600 Kannen ²
		706403 03.9901-6403.2	20748 5	5 l	144 Kannen ³
		706411 03.9901-6411.2	20750 8	20 l	36 Kannen
		706420 03.9901-6420.2	23120 6	30 l	22 Kannen
		706414 03.9901-6414.2	23005 6	50 l	6 Kannen
		706405 03.9901-6405.2	23121 3	200 l	2 Stück
SL	SAE-Spezifikation, J1704-FMVSS 116/DOT 4 ISO 4925, Klasse 4	705801 03.9901-5801.2	49001 6	1/2 l	1.200 Kannen ¹
		705802 03.9901-5802.2	49002 3	1 l	600 Kannen ²
		705803 03.9901-5803.2	49003 0	5 l	144 Kannen ³
		705811 03.9901-5811.2	29907 7	20 l	36 Kannen
		705820 03.9901-5820.2	10824 9	30 l	22 Kannen
		705814 03.9901-5814.2	10366 4	50 l	6 Kannen
		705805 03.9901-5805.2	49005 4	200 l	2 Stück
BLAU	SAE-Spezifikation, J1703-FMVSS 116/DOT 3 ISO 4925, Klasse 3	700301 03.9901-0301.2	10188 2	1/2 l	1.200 Kannen ¹
		705302 03.9901-0302.2	10190 5	1 l	600 Kannen ²
		700303 03.9901-0303.2	10192 9	5 l	144 Kannen ³

Abweichende Artikelnummern für Lieferländer außerhalb Deutschlands möglich.

Paletteneinheit:

¹20 Kannen je Karton.

²10 Kannen je Karton.

³4 Kannen je Karton.

Top quality for optimum performance.

Wide selection for all applications

ATE SecuBrake

is the new, pioneering brake fluid that combines sustainability and work safety. For the first time, it meets the legal requirements for a DOT 4 brake fluid without containing boric acid esters, and it is manufactured using a certified process with renewable raw materials.

ATE SUPER DOT 5.1

offers top performance in hot as well as cold conditions: very high wet boiling point and low viscosity. Thus it currently complies with the most stringent requirements of vehicle manufacturers. Ideal for vehicles with advanced driver assistance systems like ESP, ABS and ASR.



- | ATE SL as a proven DOT 4 grade, ATE TYPE 200 brake fluid for racing enthusiasts and ATE DOT 3 Blue for classic cars and vehicles for which the manufacturer specifies a DOT 3 brake fluid
- | ATE SL.6 is optimal for ESP, ABS and ASR: low viscosity even at low temperatures, with a fast reaction time
- | Boiling points and viscosities are better than in statutory and technical regulations
- | Protection from corrosion by high-grade additives

BENEFITS

Take a look at Expert Talk to learn more about the various kinds of brake fluids:



Properties of ATE brake fluids

	Boiling point	Wet boiling point	Viscosity at -40 °C
ATE SecuBrake	min. 260 °C	min. 155 °C	max. 700 mm ² /s
ATE SUPER DOT 5.1	min. 265 °C	min. 180 °C	max. 700 mm ² /s
ATE TYP 200 DOT 4 Racing quality	min. 280 °C	min. 198 °C	max. 1,400 mm ² /s
ATE SL.6 DOT 4 Ideal for ESP, ABS, ASR	min. 265 °C	min. 175 °C	max. 700 mm ² /s
ATE SL DOT 4	min. 260 °C	min. 165 °C	max. 1,400 mm ² /s
ATE DOT 3 Blau	min. 245 °C	min. 150 °C	max. 1,500 mm ² /s

Always follow manufacturer's instructions when using brake fluid. To maintain the operational reliability of the brake system, you must change the brake fluid in accordance with the vehicle manufacturer's recommendations on replacement intervals.

ATE service equipment simplifies work.

Of course we also offer devices for testing, bleeding and disposing of brake fluids. The devices work accurately and reliably, are easy to use and their technology is state-of-the-art.

INFORMATIONEN

To learn more about ATE brake fluids go to www.ate-brakes.com/brakefluid.
Information on our service units is available at www.ate-info.de/en.



Type	ATE item code	EAN No. 4006633	Container	Pallet unit
SECU BRAKE SAE specification, J1704-FMVSS 116/DOT 4 ISO 4925, Class 4 – low viscosity	706803 03.9901-6803.2	50307 5	5 l	144 cans ³
	706811 03.9901-6811.2	50309 9	20 l	36 cans
SUPER DOT 5.1 SAE specification, J1704-FMVSS 116/DOT 5.1 ISO 4925, Class 7 – low viscosity	706602 03.9901-6602.2	45757 6	1 l	600 cans ²
	706603 03.9901-6603.2	45759 0	5 l	144 cans ³
	706611 03.9901-6611.2	45761 3	20 l	36 cans
	706620 03.9901-6620.2	48735 1	30 l	22 cans
	706614 03.9901-6614.2	48734 4	50 l	6 cans
TYP 200 SAE specification, J1704-FMVSS 116/DOT 4 ISO 4925, Class 4	706202 03.9901-6202.2	10825 6	1 l	600 cans ²
	706203 03.9901-6203.2	12166 8	5 l	144 cans ³
	706220 03.9901-6220.2	12780 6	30 l	22 cans
SL 6 SAE specification, J1704-FMVSS 116/DOT 4 ISO 4925, Class 6 – low viscosity	706402 03.9901-6402.2	20746 1	1 l	600 cans ²
	706403 03.9901-6403.2	20748 5	5 l	144 cans ³
	706411 03.9901-6411.2	20750 8	20 l	36 cans
	706420 03.9901-6420.2	23120 6	30 l	22 cans
	706414 03.9901-6414.2	23005 6	50 l	6 cans
	706405 03.9901-6405.2	23121 3	200 l	2 items
SL SAE specification, J1704-FMVSS 116/DOT 4 ISO 4925, Class 4	705801 03.9901-5801.2	49001 6	1/2 l	1,200 cans ¹
	705802 03.9901-5802.2	49002 3	1 l	600 cans ²
	705803 03.9901-5803.2	49003 0	5 l	144 cans ³
	705811 03.9901-5811.2	29907 7	20 l	36 cans
	705820 03.9901-5820.2	10824 9	30 l	22 cans
	705814 03.9901-5814.2	10366 4	50 l	6 cans
	705805 03.9901-5805.2	49005 4	200 l	2 items
BLAU SAE specification, J1703-FMVSS 116/DOT 3 ISO 4925, Class 3	700301 03.9901-0301.2	10188 2	1/2 l	1,200 cans ¹
	700302 03.9901-0302.2	10190 5	1 l	600 cans ²
	700303 03.9901-0303.2	10192 9	5 l	144 cans ³
	700304 03.9901-0304.2	10194 3	12 oz	2,160 cans ⁴

Item codes may be different for countries of delivery other than Germany.

Pallet unit:

¹20 cans per box.
²10 cans per box.

³4 cans per box.
⁴60 cans per box.

DE Inhaltsverzeichnis

Herstellerverzeichnis
Produktdetails
Fahrzeugverwendungen
Technische Übersetzungen

8	Index of vehicles
15	Product details
167	Applications of vehicles
594	Technical translations

EN Table of contents

ES Índice

8	Índice de vehículos	8
15	Descripción del producto	15
167	Aplicaciones	167
594	Traducciones técnicas	594

FR Table des matières

Liste des véhicules
Présentation du produit
Applications
Traductions techniques

8	Indice autovetture
15	Panoramica prodotti
167	Applicazioni autoveicoli
594	Traduzioni tecniche

IT Sommario

8
15
167
594



DE Herstellerverzeichnis

EN Index of vehicles

ES Índice de vehículos

FR Liste des véhicules

IT Indice autovettura

2025

**ABARTH 168**

500 / 595 / 695	168
500C / 595C / 695C	168
GRANDE PUNTO	168
PUNTO	168
PUNTO EVO	168

ALFA ROMEO 168

145 (930_)	168
146 (930_)	168
159 (939_)	168
159 Sportwagon (939_)	168
166 (936_)	169
BRERA (939_)	169
GIULIETTA (940_)	169
GIULIETTA Kasten/Schrägheck (940_)	169
GTV (916_)	169
MITO (955_)	169
SPIDER (916_)	170
SPIDER (939_)	170

AUDI 170

A1 (8X1, 8XK)	170
A1 Allstreet (GBH)	170
A1 City Carver (GBH)	170
A1 Sportback (GBA)	170
A2 (8Z0)	170
A3 (8L1)	171
A3 (8P1)	171
A3 (8V1, 8VK)	173
A3 Cabriolet (8P7)	174
A3 Cabriolet (8V7, 8VE)	174
A3 Limousine (8VS, 8VM)	174
A3 Sportback (8PA)	175
A3 Sportback (8VA, 8VF)	177
A4 Allroad B8 (8KH)	177
A4 B5 (8D2)	178
A4 B5 Avant (8D5)	179
A4 B6 (8E2)	179
A4 B6 Avant (8E5)	180
A4 B6 Cabriolet (8H7)	180
A4 B7 (8EC)	181
A4 B7 Avant (8ED)	182
A4 B7 Cabriolet (8HE)	182
A4 B8 (8K2)	183
A4 B8 Avant (8K5)	183
A5 (8T3)	184
A5 Cabriolet (8F7)	185
A5 Sportback (8TA)	186
A6 Allroad C6 (4FH)	186
A6 Allroad C7 (4GH, 4GJ)	186
A6 C5 (4B2, 4B4)	186
A6 C5 Avant (4B5, 4B6)	188
A6 C6 (4F2)	189
A6 C6 Avant (4F5)	189
A6 C7 (4G2, 4GC)	190
A6 C7 Avant (4G5, 4GD)	190
A7 Sportback (4GA, 4GF)	191
A8 D2 (4D2, 4D8)	191
A8 D4 (4H2, 4H8, 4HC, 4HL)	191
ALLROAD C5 (4BH)	192
CABRIOLET B3 (8G7)	192
Q2 (GAB, GAG)	192
Q3 (8UB, 8UG)	192
Q3 (F3B)	192
Q3 Sportback (F3N)	193
Q5 (8RB)	193
Q5 Van (8RB)	193
Q7 (4LB)	194
Q7 Van (4LB)	194
TT (8J3)	195
TT (8N3)	195
TT (FV3, FVP)	195
TT Roadster (8J9)	196
TT Roadster (8N9)	196
TT Roadster (FV9, FVR)	196

**BMW 196**

1 (E81)	196
1 (E87)	197
1 (F20)	198
1 (F21)	199
1 (F40)	199
1 (F52)	200
1 Cabriolet (E88)	200
1 Coupe (E82)	200
1 Van (F20)	201
2 Active Tourer (F45)	201
2 Active Tourer Van (F45)	201
2 Cabriolet (F23)	201
2 Coupe (F22, F87)	202
2 Gran Coupe (F44)	202
2 Gran Tourer (F46)	202
2 Gran Tourer Van (F46)	203
3 (E46)	203
3 (E90)	204
3 (F30, F80)	205
3 Cabriolet (E46)	206
3 Cabriolet (E93)	206
3 Compact (E36)	207
3 Compact (E46)	208
3 Coupe (E46)	208
3 Coupe (E92)	209
3 Gran Turismo (F34)	210
3 Touring (E46)	211
3 Touring (E91)	211
3 Touring (F31)	213
3 Touring Van (F31)	213
4 Cabriolet (F33, F83)	213
4 Coupe (F32, F82)	214
4 Gran Coupe (F36)	214
5 (E39)	215
5 (E60)	215
5 (F10)	216
5 Gran Turismo (F07)	216
5 Touring (E39)	217
5 Touring (E61)	217
5 Touring (F11)	218
6 (E63)	218
6 Cabriolet (E64)	218
6 Cabriolet (F12)	218
6 Coupe (F13)	219
6 Gran Coupe (F06)	219
7 (E38)	219
7 (E65, E66, E67)	219
7 (F01, F02, F03, F04)	219
X1 (E84)	220
X1 (F48)	220
X1 Van (F48)	221
X2 (F39)	221
X3 (E83)	221
X3 (F25)	221
X4 (F26)	222
X5 (E53)	222
Z3 Coupe (E36)	222
Z3 Roadster (E36)	222
Z4 Coupe (E86)	222
Z4 Roadster (E85)	222
Z4 Roadster (E89)	223
Z8 Roadster (E52)	223

CHEVROLET 223

ASTRA Schrägheck	223
ASTRA Stufenheck	223
AVEO Schrägheck (T300)	223
AVEO Stufenheck (T300)	223
CORSA Kombi	223
CRUZE (J300)	223
CRUZE Schrägheck (J305)	224
CRUZE Station Wagon (J308)	224
MALIBU	224
MALIBU (V300)	225
MATIZ (M200, M250)	225
ORLANDO (J309)	225
SPARK	225
SPARK Kasten/Schrägheck (M200, M250)	226
TRAX	226

**CHEVROLET 223**

VECTRA	226
--------	-----

CHRYSLER 226

DELTA	226
VOYAGER / GRAND VOYAGER III (GS_, NS_)	226
VOYAGER / GRAND VOYAGER IV (RG)	226
VOYAGER IV (RG, RS)	226

CITROËN 226

BERLINGO / BERLINGO FIRST Großraumlimousine (MF_, GJK_, GFK_)	227
BERLINGO / BERLINGO FIRST Kasten/Großraumlimousine (M_)	227
BERLINGO Kasten/Großraumlimousine (B9)	227
BERLINGO MULTISPACE (B9)	228
BERLINGO Pritsche/Fahrgestell (B9)	228
C1 (PM_, PN_)	228
C15 Kasten/Großraumlimousine (VD_)	238
C15 Kombi	238
C15 Pritsche/Fahrgestell (VDPD)	238
C1 II (PA_, PS_)	228
C2 (JM_)	229
C2 ENTERPRISE (JG_)	229
C3 / C3 ORIGIN III (SX)	230
C3 AIRCROSS II (2R_, 2C_)	232
C3 AIRCROSS II Van (2C_, 2R_)	232
C3 I (FC_, FN_)	230
C3 II (SC_)	231
C3 III Van (SX_, SY_)	232
C3 II Kasten/Schrägheck (SC_)	232
C3 PICASSO (SH_)	232
C3 Pluriel (HB_)	232
C4 CACTUS	234
C4 CACTUS Van (0B_, 0P_)	234
C4 Coupe (LA_)	234
C4 GRAND PICASSO I (UA_)	234
C4 GRAND PICASSO II (DA_, DE_)	235
C4 I (LC_)	233
C4 II (NC_)	233
C4 II Kasten/Schrägheck (NC_)	233
C4 II Stufenheck (NC_)	234
C4 I Kasten/Schrägheck (LR_)	233
C4 I Stufenheck	233
C4 PICASSO I Großraumlimousine (UD_)	235
C4 PICASSO II	235
C4 PICASSO II Van (DD_)	235
C4 SPACETOURER (3D_)	236
C4 SPACETOURER Van (3D_)	236
C5 III (RD_)	236
C5 III Break (RW_)	236
C6 (TD_)	237
C8 (EA_, EB_)	237
C8 Van (EA_, EB_)	238
C-ELYSEE (DD_)	238
DS3 (SA_)	239
DS3 Cabriolet	239
DS4 (NX_)	239
DS5	240
EVASION Großraumlimousine (22, U6)	240
GRAND C4 SPACETOURER (3A_, 3E_)	241
GRAND C4 SPACETOURER Van (3A_, 3E_)	241
JUMPER I Bus (230P)	241
JUMPER I Bus (244, Z_)	242
JUMPER II Bus	245
JUMPER II Kasten	246
JUMPER II Pritsche/Fahrgestell	246
JUMPER I Kasten (230L)	242
JUMPER I Kasten (244)	244
JUMPER I Pritsche/Fahrgestell (230)	244
JUMPER I Pritsche/Fahrgestell (244)	245
JUMPY I (U6U_)	247
JUMPY II (VF7)	248
JUMPY II Kasten	248
JUMPY II Pritsche/Fahrgestell	248
JUMPY I Kasten (BS_, BT_, BY_, BZ_)	247

**CITROËN****226**

JUMPY I Pritsche/Fahrgestell (BU_, BV_, BW_, BX_) 247
SAXO (SO, S1) 248
SAXO Hatchback van (S3_) 248
XSARA (N1) 248
XSARA Break (N2) 249
XSARA Coupe (N0) 250
XSARA Kasten/Kombi 251
XSARA Kasten/Schrägheck (N3_) 251
XSARA PICASSO (N68) 252

CUPRA**252**

ATECA (KH7, KHP, KBP) 252

DACIA**252**

DOKKER Großraumlimousine (KE_) 252
DOKKER Kasten/Großraumlimousine 252
DUSTER (HS_) 252
DUSTER Kasten/SUV 253
LODGY (JS_) 253
LOGAN (LS_) 254
LOGAN EXPRESS (FS_) 254
LOGAN II 254
LOGAN MCV (KS_) 255
LOGAN MCV II 255
LOGAN Pick-up (US_) 255
SANDERO 256
SANDERO II 256

DAEWOO**256**

MATIZ (M100, M150) 256
MATIZ (M200, M250) 257
MATIZ (M300) 257
MATIZ Kasten/Schrägheck (KLA4) 257

DAIHATSU**257**

CHARADE VIII 257

DS**257**

DS 3 (SA_) 257
DS 3 Cabriolet (SB_) 257
DS 4 / DS 4 CROSSBACK (NX_) 257
DS 5 (KF_) 258

FIAT**258**

500 (312_) 258
500 C (312_) 258
500L (351_, 352_) 258
BARCETTA (183_) 258
BRAVA (182_) 258
BRAVO I (182_) 259
BRAVO II (198_) 259
BRAVO Van (198_) 259
COUPE (175_) 259
CROMA (194_) 259
CROMA Kasten/Kombi (194_) 259
DOBLO Bus (263_) 260
DOBLO Cargo (263_) 260
DOBLO Großraumlimousine (119_, 223_) 260
DOBLO Kasten/Großraumlimousine (223_) 260
DOBLO Pritsche/Fahrgestell (263_) 260
DUCATO Bus (230_) 261
DUCATO Bus (244_) 262
DUCATO Bus (250_) 262
DUCATO Kasten (230_) 263
DUCATO Kasten (244_) 265
DUCATO Kasten (250_) 265
DUCATO Pritsche/Fahrgestell (230_) 266
DUCATO Pritsche/Fahrgestell (244_) 267
DUCATO Pritsche/Fahrgestell (250_) 267
FIORINO Großraumlimousine (225_) 269
FIORINO Kasten/Großraumlimousine (146_) 269
FIORINO Kasten/Großraumlimousine (225_) 269

**FIAT****258**

FIORINO Pick up (146_) 269
GRANDE PUNTO (199_) 269
GRANDE PUNTO Van (199_) 270
IDEA (350_) 270
IDEA Van (350_) 271
LINEA (323_, 110_) 271
MAREA (185_) 271
MAREA Weekend (185_) 271
PALIO (178_, 171_, 371_) 271
PALIO Weekend (178_, 173_, 373_, 374_, 171_) 271
PANDA / PANDA CLASSIC (169_) 272
PANDA (141_) 272
PANDA (312_, 319_) 272
PANDA Kasten/Schrägheck (141_) 272
PANDA Kasten/Schrägheck (169_) 273
PANDA VAN (312_, 519_) 273
PUNTO (188_) 273
PUNTO (199_) 274
PUNTO Cabriolet (176_) 274
PUNTO EVO (199_) 274
PUNTO EVO Kasten/Schrägheck (199_) 274
PUNTO Kasten/Schrägheck (188_) 274
PUNTO Kasten/Schrägheck (199_) 275
PUNTO Van (176_) 275
QUBO (225_) 275
SCUDO Bus (220_) 275
SCUDO Bus (270_, 272_) 275
SCUDO Kasten (220_) 275
SCUDO Kasten (270_, 272_) 276
SCUDO Pritsche/Fahrgestell (220_) 276
SCUDO Pritsche/Fahrgestell (270_, 272_) 276
SEDICI (189_) 276
SEICENTO / 600 (187_) 276
SEICENTO / 600 Kasten/Schrägheck (287_) 276
SIENA (178_, 172_, 372_) 276
STRADA Pick-up (178_, 278_) 276
TIPO Kombi (356_, 357_) 276
TIPO Schrägheck (356_, 357_) 277
TIPO Stufenheck (356_, 357_) 277
ULYSSE (179_) 277
ULYSSE (220_) 277

FORD**277**

B-MAX (JK) 277
B-MAX Van (JK) 277
C-MAX (DM2) 278
C-MAX II (DXA/CB7, DXA/CEU) 278
C-MAX II Van 278
COUGAR (EC_) 279
ESCORT CLASSIC (AAL, ABL) 279
ESCORT CLASSIC Turnier (ANL) 279
ESCORT VI Express (AVL) 279
FIESTA IV (JA_, JB_) 279
FIESTA Kasten/Großraumlimousine (J5_, J3_) 281
FIESTA Kasten/Schrägheck (JV_) 281
FIESTA Stufenheck 281
FIESTA V (JH_, JD_) 279
FIESTA VI (CB1, CCN) 280
FIESTA VI Van 280
FIESTA V Van 280
FOCUS C-MAX (DM2) 289
FOCUS I (DAW, DBW) 281
FOCUS II (DA_, HCP, DP) 282
FOCUS II Cabriolet 284
FOCUS III 287
FOCUS III Kasten/Kombi 288
FOCUS III Kasten/Schrägheck 288
FOCUS III Stufenheck 288
FOCUS III Turnier 288
FOCUS II Kasten/Kombi 284
FOCUS II Stufenheck (DB_, FCH, DH) 285
FOCUS II Turnier (DA_, FFS, DS) 286
FOCUS I Kasten/Kombi (DNW) 281
FOCUS I Stufenheck (DFW) 282
FOCUS I Turnier (DNW) 282
FUSION (JU_) 289
GALAXY I (WGR) 290

**FORD****277**

GALAXY II (WA6) 291
GALAXY MK II VAN (WA6) 291
GALAXY MK I VAN (WGR) 291
GRAND C-MAX (DXA/CB7, DXA/CEU) 291
GRAND C-MAX Van 291
KA 292
KA (RU8) 292
KUGA I 292
KUGA II (DM2) 292
KUGA II VAN 293
KUGA I VAN 292
MONDEO II (BAP) 293
MONDEO III (B5Y) 293
MONDEO III Stufenheck (B4Y) 293
MONDEO III Turnier (BWY) 294
MONDEO II Stufenheck (BFP) 293
MONDEO II Turnier (BNP) 293
MONDEO IV (BA7) 294
MONDEO IV Stufenheck (BA7) 294
MONDEO IV Turnier (BA7) 294
MONDEO IV Van 295
PUMA (EC_) 295
RANGER (ET) 295
S-MAX (WA6) 295
S-MAX VAN (WA6) 295
TOURNEO CONNECT / GRAND 295
TOURNEO CONNECT V408 Großraumlimousine 296
TOURNEO COURIER B460 Großraumlimousine 296
TOURNEO CUSTOM V362 Bus (F3) 296
TRANSIT Bus (E_) 296
TRANSIT Bus (FD_, FB_, FS_, FZ_, FC_) 296
TRANSIT CONNECT Großraumlimousine 297
TRANSIT CONNECT V408 Kasten/Großraumlimousine 297
TRANSIT COURIER B460 Großraumlimousine 297
TRANSIT COURIER B460 Kasten/Großraumlimousine 297
TRANSIT CUSTOM V362 Bus (F3) 297
TRANSIT CUSTOM V362 Kasten (FY, FZ) 297
TRANSIT Kasten (E_) 297
TRANSIT Kasten (FA_) 297
TRANSIT Pritsche/Fahrgestell (E_) 298
TRANSIT Pritsche/Fahrgestell (FM_, FN_, FF_) 298
TRANSIT Pritsche/Fahrgestell (FM_, FN_) 298
TRANSIT TOURNEO Bus 298
TRANSIT TOURNEO Bus (FC_) 299

HONDA**299**

ACCORD VII (CL, CN) 299
ACCORD VII Tourer (CM, CN) 299
CIVIC VI Coupe (EJ, EM1) 299
CIVIC VI Hatchback (EJ, EK) 299
CIVIC VIII Hatchback (FN, FK) 299
CIVIC VI Stufenheck (EJ, EK, SO) 299

HYUNDAI**299**

ATOS (MX) 299
GETZ (TB) 299
i10 I (PA) 300
i10 II (BA, IA) 300
i10 II Stufenheck 300
i30 (GD) 300
i30 Coupe 300
i30 Hatchback Van (GDE) 300
i30 Kombi (GD) 300
i30 Kombi Van (GDE, GD) 301
i40 I (VF) 301
i40 I CW (VF) 301
i40 I Kombi Van (VF) 301
ix20 (JC) 301
ix35 (LM, EL, ELH) 301
ix35 Van 302
MATRIX (FC) 302



**HYUNDAI 299**

TUCSON (TL, TLE)	302
VELOSTER (FS)	302

JAGUAR 302

S-TYPE II (X200)	302
XF I (X250)	303
XF SPORTBRAKE (X250)	303
XJ (X350, X358)	303
XJ (X351)	303
XK 8 Convertible (X100)	304
XK 8 Coupe (X100)	304
XK II Cabriolet (X150)	304
XK II Coupe (X150)	304

JEEP 304

COMPASS (MP, M6, MV, M7)	304
RENEGADE SUV (BU, B1, BV)	304
RENEGADE VAN (BU, B1)	304

KIA 304

CEE'D (JD)	304
CEE'D Combi Van (JD)	305
CEE'D Sportswagon (JD)	305
PRO CEE'D (JD)	305
PRO CEE'D Hatchback Van (JD)	305
SORENTO I (JC)	306
SPORTAGE III (SL)	306
SPORTAGE IV (QL, QLE)	306
SPORTAGE IV VAN (QL, QLE)	306

LADA 306

110 (2110)	306
111 (2111)	307
112 (2112)	307
1200-1600	307
NOVA (2105)	307
NOVA Kombi (2104)	307
SAMARA (2108, 2109, 2113, 2114)	307
SAMARA Schrägheck (2113, 2114)	307
SAMARA Stufenheck (21099, 2115)	307
TAIGA Geländewagen geschlossen (2121, 2131)	307

LANCIA 307

DELTA III (844_)	307
MUSA (350_)	308
PHEDRA (179_)	308
Y (840_)	308
YPSILON (843_)	308
ZETA (22_)	308

LAND ROVER 308

DISCOVERY IV (L319)	308
DISCOVERY IV VAN (L319)	309
FREELANDER 2 (L359)	309
FREELANDER 2 VAN (L359)	309
RANGE ROVER EVOQUE (L538)	309
RANGE ROVER EVOQUE Cabriolet (L538)	309
RANGE ROVER EVOQUE VAN (L538)	309
RANGE ROVER III (L322)	309
RANGE ROVER SPORT I (L320)	310

LEXUS 310

NX (_Z1_)	310
-----------	-----

MAZDA 310

2 (DY)	310
3 (BK)	310
3 (BL)	310
3 Stufenheck (BK)	310

**MAZDA 310**

3 Stufenheck (BL)	310
6 Hatchback (GG)	311
6 Kasten/Kombi (GJ)	311
6 Kombi (GJ, GL)	311
6 Station Wagon (GY)	311
6 Stufenheck (GG)	311
6 Stufenheck (GJ, GL)	311
BT-50 Pick-up (CD, UN)	312
BT-50 Pritsche/Fahrgestell (CD, UN)	312
CX-5 (KE, GH)	312
CX-5 (KF)	312
CX-5 Van (KE_)	312

MERCEDES-BENZ 312

A-KLASSE (W168)	312
A-KLASSE (W169)	313
A-KLASSE (W176)	313
B-KLASSE Sports Tourer (W245)	313
B-KLASSE Sports Tourer (W246, W242)	313
C-KLASSE (W202)	314
C-KLASSE (W203)	314
C-KLASSE (W204)	316
C-KLASSE (W205)	317
C-KLASSE Cabriolet (A205)	318
C-KLASSE Coupe (C204)	318
C-KLASSE Coupe (C205)	319
C-KLASSE Sportcoupe (CL203)	319
C-KLASSE T-Model (S202)	320
C-KLASSE T-Model (S203)	320
C-KLASSE T-Model (S204)	321
C-KLASSE T-Model (S205)	322
CLA Coupe (C117)	323
CLA Shooting Brake (X117)	324
CLC-KLASSE (CL203)	324
CLK (C208)	324
CLK (C209)	324
CLK Cabriolet (A208)	325
CLK Cabriolet (A209)	326
CLS (C218)	326
CLS (C219)	327
CLS (C257)	327
CLS Shooting Brake (X218)	327
E-KLASSE (W210)	328
E-KLASSE (W211)	328
E-KLASSE (W212)	329
E-KLASSE (W213)	330
E-KLASSE All-Terrain (S213)	331
E-KLASSE Cabriolet (A207)	331
E-KLASSE Cabriolet (A238)	331
E-KLASSE Coupe (C207)	332
E-KLASSE Coupe (C238)	332
E-KLASSE Pritsche/Fahrgestell (VF211)	333
E-KLASSE T-Model (S210)	333
E-KLASSE T-Model (S211)	334
E-KLASSE T-Model (S212)	334
E-KLASSE T-Model (S213)	335
EQC (N293)	336
G-CLASS Geländewagen geschlossen (W464)	336
G-CLASS Pritsche/Fahrgestell (W464)	336
G-KLASSE (W461)	336
G-KLASSE (W463)	336
G-KLASSE Cabrio (W463)	336
G-KLASSE Pritsche/Fahrgestell (W461)	336
GLA-KLASSE (X156)	336
GLC (X253)	337
GLC Coupe (C253)	337
GLK-KLASSE (X204)	338
GL-KLASSE (X164)	338
M-KLASSE (W163)	338
M-KLASSE (W164)	339
R-KLASSE (W251, V251)	339
S-KLASSE (W220, V220)	340
S-KLASSE (W221, V221)	340
S-KLASSE Coupe (C215)	342
S-KLASSE Coupe (C216)	342
SL (R129)	342
SL (R230)	342
SL (R231)	342

**MERCEDES-BENZ 312**

SLC (R172)	343
SLK (R170)	343
SLK (R171)	343
SLK (R172)	343
SPRINTER 2-t Bus (B901, B902)	343
SPRINTER 2-t Kasten (B901, B902)	344
SPRINTER 2-t Pritsche/Fahrgestell (B901, B902)	344
SPRINTER 3,5-t Bus (B906)	344
SPRINTER 3,5-t Kasten (B906)	344
SPRINTER 3,5-t Kasten (B907, B910)	345
SPRINTER 3,5-t Pritsche/Fahrgestell (B906)	345
SPRINTER 3,5-t Pritsche/Fahrgestell (B907, B910)	345
SPRINTER 3,5-t Tourer Bus (B907)	345
SPRINTER 3-t Bus (B903)	345
SPRINTER 3-t Bus (B906)	346
SPRINTER 3-t Kasten (B903)	346
SPRINTER 3-t Kasten (B906)	346
SPRINTER 3-t Kasten (B910)	346
SPRINTER 3-t Pritsche/Fahrgestell (B903)	346
SPRINTER 3-t Pritsche/Fahrgestell (B906)	347
SPRINTER 3-t Pritsche/Fahrgestell (B910, B907)	347
SPRINTER 3-t Tourer Bus (B907)	347
SPRINTER 4,6-t Bus (B906)	347
SPRINTER 4,6-t Kasten (B906)	347
SPRINTER 4,6-t Pritsche/Fahrgestell (B906)	347
SPRINTER 4-t Bus (B904)	348
SPRINTER 4-t Kasten (B904)	348
SPRINTER 4-t Kasten (B907, B910)	348
SPRINTER 4-t Pritsche/Fahrgestell (B904)	348
SPRINTER 4-t Pritsche/Fahrgestell (B907, B910)	349
SPRINTER 4-t Tourer Bus (B907)	349
SPRINTER 5-t Bus (B906)	349
SPRINTER 5-t Kasten (B906)	349
SPRINTER 5-t Kasten (B907)	349
SPRINTER 5-t Pritsche/Fahrgestell (B906)	349
SPRINTER 5-t Pritsche/Fahrgestell (B907)	350
VANEO (414)	350
VARIO Bus (B670)	350
VARIO Kasten (B667, B670, B668)	350
VARIO Pritsche/Fahrgestell (B670, B668, B667)	351
VARIO Triebkopf	351
VIANO (W639)	351
VITO / MIXTO Kasten (W639)	351
VITO Bus (W638)	352
VITO Bus (W639)	352
VITO Kasten (W638)	352
V-KLASSE (638/2)	352

MINI 352

MINI (F55)	352
MINI (F56)	353
MINI (R50, R53)	353
MINI (R56)	353
MINI Cabriolet (F57)	354
MINI Cabriolet (R52)	354
MINI Cabriolet (R57)	354
MINI CLUBMAN (F54)	354
MINI CLUBMAN (R55)	354
MINI CLUBVAN (R55)	355
MINI COUNTRYMAN (F60)	355
MINI COUNTRYMAN (R60)	355
MINI Coupe (R58)	355
MINI PACEMAN (R61)	356
MINI Roadster (R59)	356

MITSUBISHI 356

CARISMA (DA_)	356
CARISMA Stufenheck (DA_)	356
COLT CZC VI Cabriolet (RG)	356
COLT Kasten/Schrägheck (Z3_V)	356
COLT VI (Z3_A, Z2_A)	356

**NISSAN****356**

BLUEBIRD SYLPHY / SYLPHY III (B17)	356
INTERSTAR Bus (X70)	356
INTERSTAR Kasten (X70)	357
INTERSTAR Pritsche/Fahrgestell (X70)	357
KUBISTAR Kasten (X76)	357
MICRA C+C III (K12)	358
MICRA II (K11)	357
MICRA III (K12)	357
NAVARA NP300 (D40)	358
NAVARA NP300 Pritsche/Fahrgestell (D40)	358
NOTE (E11, NE11)	358
NOTE VAN (E11)	358
NP300 PICKUP (D22)	358
PATHFINDER III (R51)	359
PATHFINDER III VAN (R51_)	359
PRIMASTAR Bus (X83)	359
PRIMASTAR Kasten (X83)	359
PRIMASTAR Pritsche/Fahrgestell (X83)	359
PRIMERA (P12)	359
PRIMERA Hatchback (P12)	360
PRIMERA Kombi (WP12)	360
PULSAR Schrägheck (C13)	360
QASHQAI / QASHQAI +2 I (J10, NJ10, JJ10E)	360
QASHQAI / QASHQAI +2 I VAN (J10, JJ10E)	360
QASHQAI II SUV (J11, J11_)	360
QASHQAI II VAN (J11_)	361
SENTRA VII (B17)	361
TIIDA Schrägheck (C12)	361
X-TRAIL I (T30)	361
X-TRAIL III (T32_, T32R, T32RR)	361
X-TRAIL VAN (T32)	361

OPEL**361**

ADAM (M13)	362
AGILA (A) (H00)	362
AGILA (B) (H08)	362
ASTRA F Cabriolet (T92)	362
ASTRA F CLASSIC Caravan (T92)	362
ASTRA F CLASSIC CC (T92)	362
ASTRA F CLASSIC Stufenheck (T92)	362
ASTRA G Cabriolet (T98)	362
ASTRA G Caravan (T98)	363
ASTRA G CC (T98)	363
ASTRA G CLASSIC (T98)	364
ASTRA G CLASSIC Caravan (F35)	364
ASTRA G CLASSIC Stufenheck (T98)	364
ASTRA G Coupe (T98)	364
ASTRA G Kasten/Kombi (F70)	365
ASTRA G Stufenheck (T98)	365
ASTRA H (A04)	365
ASTRA H Caravan (A04)	366
ASTRA H CLASSIC Kombi (A04)	366
ASTRA H CLASSIC Schrägheck (A04)	367
ASTRA H CLASSIC Stufenheck (A04)	367
ASTRA H GTC (A04)	367
ASTRA H Kasten/Kombi (L70)	368
ASTRA H Stufenheck (A04)	369
ASTRA H TwinTop (A04)	369
ASTRA J (P10)	369
ASTRA J Caravan (P10)	370
ASTRA J GTC	371
ASTRA J Kasten/Kombi (P10)	371
ASTRA J Kasten/Schrägheck (P10)	371
ASTRA J Stufenheck	371
CASCADA (W13)	372
COMBO Kasten/Großraumlimousine	372
COMBO Kasten/Großraumlimousine (71_)	372
COMBO Tour	372
CORSA B (S93)	372
CORSA B Kasten/Schrägheck (S93)	373
CORSA B Kombi (S93)	373
CORSA C (X01)	373
CORSA C Kasten/Schrägheck (X01)	373
CORSA D (S07)	373
CORSA D Kasten/Schrägheck (S07)	374
CORSA E (X15)	374
CORSA E Kasten/Schrägheck (X15)	375

**OPEL****361**

CROSSLAND X / CROSSLAND (P17, P2QO)	375
CROSSLAND X Van	375
INSIGNIA A (G09)	375
INSIGNIA A Country Tourer (G09)	376
INSIGNIA A Sports Tourer (G09)	376
INSIGNIA A Stufenheck (G09)	377
MERIVA A Großraumlimousine (X03)	378
MOKKA / MOKKA X (J13)	378
MOKKA X VAN (J13)	378
MOVANO A Bus (X70)	378
MOVANO A Kasten (X70)	378
MOVANO A Pritsche/Fahrgestell (X70)	378
MOVANO C Kasten (U9)	379
MOVANO C Pritsche/Fahrgestell (U9)	379
OMEGA B (V94)	379
OMEGA B Caravan (V94)	379
SIGNUM CC (Z03)	379
TIGRA (S93)	380
TIGRA TwinTop (X04)	380
VECTRA B (J96)	380
VECTRA B Caravan (J96)	380
VECTRA B CC (J96)	380
VECTRA C (Z02)	381
VECTRA C Caravan (Z02)	381
VECTRA C CC (Z02)	381
VIVARO A Bus (X83)	381
VIVARO A Kasten (X83)	382
VIVARO A Pritsche/Fahrgestell (X83)	382
ZAFIRA / ZAFIRA FAMILY B (A05)	382
ZAFIRA A Großraumlimousine (T98)	383
ZAFIRA B Kasten/Großraumlimousine (A05)	383
ZAFIRA TOURER C (P12)	384
ZAFIRA TOURER C VAN (P12)	384

PEUGEOT**384**

1007 (KM_)	406
106 II (1A_, 1C_)	384
106 Van II Kasten/Schrägheck (1S_)	385
107 (PM_, PN_)	385
108	385
2008 I (CU_)	406
2008 I Van (CU_)	407
206+ (2L_, 2M_)	390
206 CC (2D)	385
206 Schrägheck (2A/C)	385
206 Stufenheck	388
206 SW (2E/K)	388
206 Van	390
207 (WA_, WC_)	390
207 CC (WD_)	391
207 Kasten/Schrägheck (WA_, WC_)	391
207 Stufenheck	391
207 SW (WK_)	391
207 SW Kasten/Kombi (WK_)	391
208 I (CA_, CC_)	392
208 Kasten/Schrägheck (CR_)	392
3008 I Großraumlimousine (0U_)	407
3008 Van (0U_)	407
301	392
306 (7B, N3, N5)	392
306 Break (7E, N3, N5)	395
306 Cabriolet (7D, N3, N5)	395
306 Kasten/Kombi (N_, 7_)	396
306 Kasten/Schrägheck	396
306 Schrägheck (7A, 7C, N3, N5)	396
307 (3A/C)	398
307 Break (3E)	399
307 CC (3B)	399
307 Stufenheck	399
307 SW (3H)	399
307 SW Kasten/Kombi (3E_, 3H_)	399
308 CC (4B_)	400
308 I (4A_, 4C_)	399
308 II (LB_, LP_, LW_, LH_, L3_)	399
308 Kasten/Schrägheck (LB_)	400
308 SW I (4E_, 4H_)	400
308 SW II (LC_, LJ_, LR_, LX_, L4_)	400
308 SW II Kasten/Kombi (LC_)	401

**PEUGEOT****384**

308 SW I Kasten/Kombi (4E_)	400
406 (8B)	401
406 Break (8E/F)	402
406 Coupe (8C)	403
407 (6D_)	403
407 Coupe (6C_)	404
407 SW (6E_, 6D_)	404
407 SW Kasten/Kombi (6E_)	404
5008 (0U_, 0E_)	407
5008 I Van (0U_)	408
508 I (8D_)	405
508 SW I (8E_)	405
508 SW Kasten/Kombi (8E_)	405
806 (221)	405
807 (EB_)	406
807 Van (EB_)	406
BOXER Bus	408
BOXER Bus (230P)	408
BOXER Bus (244, Z_)	410
BOXER Kasten	411
BOXER Kasten (230L)	411
BOXER Kasten (244)	413
BOXER Pritsche/Fahrgestell	413
BOXER Pritsche/Fahrgestell (244)	413
BOXER Pritsche/Fahrgestell (ZCT_)	413
EXPERT (224_)	415
EXPERT Kasten (222)	415
EXPERT Kasten (VF3A_, VF3U_, VF3X_)	415
EXPERT Pritsche/Fahrgestell	415
EXPERT Pritsche/Fahrgestell (223)	415
EXPERT TEPEE (VF3X_)	416
PARTNER Großraumlimousine (5_, G_)	416
PARTNER Kasten/Großraumlimousine	417
PARTNER Kasten/Großraumlimousine (5_, G_)	417
PARTNER ORIGIN Großraumlimousine (G_)	417
PARTNER ORIGIN Kasten/Großraumlimousine (G_)	417
PARTNER Pritsche/Fahrgestell	418
PARTNER Pritsche/Fahrgestell (5_, G_)	418
PARTNER TEPEE	418
RCZ	418

PORSCHE**418**

911 (996)	418
911 (997)	419
911 Cabriolet (996)	419
911 Cabriolet (997)	419
911 Targa (996)	419
BOXSTER (986)	419
BOXSTER (987)	419
BOXSTER Spyder (987)	419
CAYENNE (9PA)	419
CAYMAN (987)	420

RENAULT**420**

19 II Cabriolet (D53_, 853_)	420
AVANTIME (DE0_)	420
CAPTUR I (J5_, H5_)	420
CLIO II (BB_, CB_)	420
CLIO III (BR0/1, CR0/1)	421
CLIO III Grandtour (KR0/1_)	422
CLIO III Kasten/Schrägheck (SB_, SR_)	423
CLIO II Kasten/Schrägheck (SB0/1/2_)	421
CLIO IV (BH_)	423
CLIO IV Grandtour (KH_)	423
CLIO IV Kasten/Kombi (KH_)	424
CLIO IV Kasten/Schrägheck (BH_)	424
DOKKER	424
DUSTER (HS_)	424
ESPACE III (JE0_)	424
ESPACE IV (JK0/1_)	425
GRAND SCÉNIC II (JM0/1_)	425
GRAND SCÉNIC III (JZ0/1_)	425
KADJAR (HA_, HL_)	425
KANGOO / GRAND KANGOO II (KW0/1_)	426
KANGOO (KE0/1_)	426
KANGOO BC BOP (KW0/1_)	426



**RENAULT****420**

KANGOO Express (FC0/1_)	426
KANGOO Express (FW0/1_)	426
KAPTUR (H5_)	427
KOLEOS II (HC_)	427
LAGUNA I (B56_ 556_)	427
LAGUNA I Grandtour (K56_)	427
LAGUNA II (BG0/1_)	428
LAGUNA II Grandtour (KG0/1_)	429
LODGY (JS_)	431
LOGAN/STEPWAY II (L8_)	431
LOGAN EXPRESS (US_)	431
LOGAN I (LS_)	431
LOGAN II Kombi (K8_)	431
LOGAN I Kombi (KS_)	431
MASTER II Bus (JD)	432
MASTER III Bus (JV)	432
MASTER III Kasten (FV)	433
MASTER III Pritsche/Fahrgestell (EV, HV, UV)	433
MASTER II Kasten (FD)	432
MASTER II Pritsche/Fahrgestell (ED/HD/UD)	432
MEGANE CC (EZ0/1_)	442
MEGANE I (BA0/1_)	434
MEGANE I Cabriolet (EA0/1_)	435
MEGANE I Classic (LA0/1_)	436
MEGANE I Coach (DA0/1_)	437
MEGANE I Grandtour (KA0/1_)	438
MEGANE I Hatchback Van (SA0/1_)	438
MEGANE II (BM0/1_ CM0/1_)	439
MEGANE II Coupé-Cabriolet (EM0/1_)	440
MEGANE II Hatchback Van (KM0/2_)	440
MEGANE III Combi Van (KZ0/1)	441
MEGANE III Coupe (DZ0/1_)	441
MEGANE III Grandtour (KZ0/1)	441
MEGANE III Hatchback Van (BZ_)	442
MEGANE III Schrägheck (BZ0/1_ B3_)	442
MEGANE II Kasten/Kombi (KM_)	440
MEGANE II Kombi (KM0/1_)	440
MEGANE II Stufenheck (LM0/1_)	440
Megane I Kombi van (KA_)	439
MODUS / GRAND MODUS (F/JP0_)	442
SAFRANE II (B54_)	443
SANDERO/STEPWAY I (BS_)	443
SANDERO/STEPWAY II (B8_)	443
SCÉNIC I Großraumlimousine (JA0/1_ FA0_)	443
SCÉNIC II (JM0/1_)	444
SCÉNIC III (JZ0/1_)	444
SCÉNIC III VAN (JZ0/1_)	445
THALIA I (LB_)	445
THALIA II (LU_)	445
THALIA III (L8_)	445
TRAFIC Bus (T_ P_ V_)	446
TRAFIC II Bus (JL)	445
TRAFIC II Kasten (FL)	446
TRAFIC II Pritsche/Fahrgestell (EL)	446
TRAFIC Kasten (T_ P_ V_)	446
TWINGO I (C06_)	447
TWINGO II (CN0_)	447
TWINGO III (BCM_ BCA_)	447
TWINGO II Kasten/Schrägheck (CNO_)	447
TWINGO I Kasten/Schrägheck (S06_)	447
VEL SATIS (BJ0_)	447
WIND (E4M_)	448

SAAB**448**

9-3 (YS3D)	448
9-3 (YS3F, E79, D79, D75)	448
9-3 Cabriolet (YS3D)	449
9-3 Cabriolet (YS3F)	449
9-3 Kombi (E50)	449
9-3X (YS3)	449
9-5 (YS3E)	450
9-5 (YS3G)	450
9-5 Kombi (YS3E)	450

**SEAT****450**

ALHAMBRA (710, 711)	452
ALHAMBRA (7V8, 7V9)	450
ALHAMBRA VAN (711)	452
ALHAMBRA VAN (7V8, 7V9)	452
ALTEA (5P1)	452
ALTEA XL (5P5, 5P8)	454
ARONA (KJ7, KJP)	456
AROSA (6H1)	456
ATECA (KH7, KHP)	456
CORDOBA (6K1, 6K2)	456
CORDOBA (6L2)	457
CORDOBA Vario (6K5)	458
CORDOBA VARIO Kasten/Kombi (6K5)	458
EXEO (3R2)	458
EXEO ST (3R5)	459
IBIZA II (6K1)	459
IBIZA III (6L1)	460
IBIZA IV (6J5, 6P1)	460
IBIZA IV Kasten/Schrägheck (6J1)	461
IBIZA IV SC (6J1, 6P5)	461
IBIZA IV ST (6J8, 6P8)	461
IBIZA V (KJ1, KJG)	461
INCA (6K9)	461
LEON (1M1)	462
LEON (1P1)	463
LEON (5F1)	466
LEON Kasten/Schrägheck (5F1)	467
LEON SC (5F5)	468
LEON ST (5F8)	468
LEON ST Kasten/Kombi (5F8)	469
Mii (KF1, KE1)	470
TOLEDO II (1M2)	470
TOLEDO III (5P2)	470

SKODA**471**

CITIGO (NF1)	471
FABIA I (6Y2)	471
FABIA I Kombi (6Y5)	471
FABIA II (542)	472
FABIA II Kombi (545)	474
FABIA II Praktik (545)	474
FABIA I Praktik (6Y5)	472
FABIA I Stufenheck (6Y3)	472
FELICIA I Pick-up (6UF, 6U7)	475
KAMIQ (NW4)	475
KAROQ (NU7, ND7)	475
KODIAQ I (NS6, NS7, NV7)	475
OCTAVIA I (1U2)	475
OCTAVIA I Kombi (1U5)	476
OCTAVIA II (1Z3)	478
OCTAVIA II Kombi (1Z5)	479
OCTAVIA III (5E3, NL3, NR3)	480
OCTAVIA III Kombi (5E5, 5E6)	481
OCTAVIA I Kasten/Kombi (1U5)	477
ROOMSTER (5J7)	481
ROOMSTER Praktik (5J)	482
SCALA (NW1)	482
SUPERB I (3U4)	482
SUPERB II (3T4)	482
SUPERB III (3V3)	483
SUPERB III Kombi (3V5)	484
SUPERB II Kombi (3T5)	483
YETI (5L)	484

SMART**484**

CITY-COUPÉ (450)	484
CROSSBLADE (450)	484
FORFOUR (454)	485
FORFOUR Schrägheck (453)	485
FORTWO Cabrio (450)	485
FORTWO Cabrio (451)	485
FORTWO Cabriolet (453)	485
FORTWO Coupe (450)	485
FORTWO Coupe (451)	485
FORTWO Coupe (453)	485

**SUBARU****485**

JUSTY III (G3X)	486
-----------------	-----

SUZUKI**486**

IGNIS II (MH)	486
JIMNY Geländewagen geschlossen (SN)	486
JIMNY Geländewagen offen (SN)	486
SPLASH (EX)	486
SWIFT III (MZ, EZ)	486
SX4 (EY, GY)	486
SX4 Stufenheck (GY, RW)	487
WAGON R+ (MA)	487
WAGON R Schrägheck (MH21, MH22)	487

TOYOTA**487**

AURIS (_E15_)	487
AVENSIS (_T25_)	487
AVENSIS Kombi (_T25_)	487
AVENSIS Kombi (_T27_)	487
AVENSIS Stufenheck (_T25_)	488
AVENSIS Stufenheck (_T27_)	488
AYGO (_B1_)	488
AYGO (_B4_)	488
AYGO Kasten/Schrägheck (_B1_)	488
COROLLA (_E12_)	488
COROLLA Kombi (_E12_)	489
COROLLA Stufenheck (_E12_)	489
COROLLA Stufenheck (_E15_)	489
COROLLA Stufenheck (_E18_ ZRE1_)	490
COROLLA Verso (_E12_)	490
COROLLA Verso (ZER_ ZZE12_ R1_)	490
RAV 4 II (_A2_)	490
RAV 4 III (_A3_)	490
RAV 4 IV (_A4_)	490
RAV 4 IV VAN (_A4_)	491
YARIS / VIOS Stufenheck (_P9_)	491
YARIS (_P1_)	491
YARIS (_P13_)	491
YARIS (_P9_)	491
YARIS Kasten/Schrägheck (_P13_)	492

VAUXHALL**492**

ADAM (M13)	492
AGILA Mk I (A) (H00)	492
AGILA Mk II (B) (H08)	492
ASTRA Mk III (F) Cabriolet (T92)	492
ASTRA Mk IV (G) Cabriolet (T98)	492
ASTRA Mk IV (G) CC (T98)	492
ASTRA Mk IV (G) Coupe (T98)	493
ASTRA Mk IV (G) Kombi (T98)	493
ASTRA Mk IV (G) Stufenheck (T98)	494
ASTRA Mk V (H) (A04)	494
ASTRA Mk V (H) Kombi (A04)	495
ASTRA Mk V (H) Sport Hatch (A04)	496
ASTRA Mk V (H) TwinTop (A04)	496
ASTRA Mk VI (J) (P10)	497
ASTRA Mk VI (J) GTC (P10)	497
ASTRA Mk VI (J) Kombi (P10)	498
ASTRAVAN Mk IV (G) Kasten/Kombi (T98)	498
ASTRAVAN Mk V (H) Kasten/Kombi (A04)	499
CASCADA Cabriolet (W13)	499
COMBO Mk I (B) (S93)	499
COMBO Mk II (C) Kasten/Großraumlimousine (F25)	499
COMBO TOUR Mk II (C) (F25)	499
CORSA Mk I (B) (S93)	500
CORSA Mk II (C) (X01)	500
CORSA Mk III (D) (S07)	500
CORSA Mk IV (E) (X15)	501
CORSAVAN Mk I (B) Kasten/Schrägheck (S93)	501
CORSAVAN Mk II (C) Kasten/Schrägheck (X01)	501
CORSAVAN Mk III (D) Kasten/Schrägheck (S07)	501
CORSAVAN Mk IV (E) Kasten/Schrägheck (X15)	502
CROSSLAND X / CROSSLAND (P17)	502

**VAUXHALL****492**

INSIGNIA Mk I (A) Country Tourer (G09)	502
INSIGNIA Mk I (A) Schrägheck (G09)	502
INSIGNIA Mk I (A) Sports Tourer (G09)	503
INSIGNIA Mk I (A) Stufenheck (G09)	504
MERIVA A (X03)	504
MOKKA / MOKKA X (J13)	505
MOVANO Mk I (A) Chassis/Cab (X70)	505
MOVANO Mk I (A) Combi (X70)	505
MOVANO Mk I (A) Van (X70)	505
MOVANO Mk III (C) Chassis/Cab (U9)	506
MOVANO Mk III (C) VAN (U9)	506
OMEGA (B) Kombi (V94)	506
OMEGA (B) Stufenheck (V94)	506
SIGNUM (Z03)	506
TIGRA Mk I (S93)	506
TIGRA TwinTop (X04)	507
VECTRA (B) CC (J96)	507
VECTRA (B) Kombi (J96)	507
VECTRA (B) Stufenheck (J96)	508
VECTRA Mk II (C) (Z02)	509
VECTRA Mk II (C) CC (Z02)	509
VECTRA Mk II (C) Kombi (Z02)	509
VIVARO A Bus (X83)	509
VIVARO A Kasten (X83)	510
VIVARO A Pritsche/Fahrgestell (X83)	510
ZAFIRA A (T98)	510
ZAFIRA Mk II (B) (A05)	510
ZAFIRA Mk III (P12)	511

VOLVO**511**

C30 (533)	511
C70 I Cabriolet (873)	512
C70 I Coupe (872)	512
C70 II Cabriolet (542)	513
S40 I (644)	513
S40 II (544)	513
S60 I (384)	514
S60 II (134)	517
S60 II Cross Country (134)	518
S70 (874)	518
S80 I (184)	519
S80 II (124)	520
V40 Cross Country (526)	521
V40 Kasten/Schrägheck (525)	521
V40 Kombi (645)	521
V40 Schrägheck (525)	522
V50 (545)	522
V60 I (155)	523
V60 I Cross Country (157)	524
V60 I Kasten/Kombi (155)	524
V70 I (875, 876)	524
V70 II (285)	524
V70 III (135)	527
V70 III Kasten/Kombi (135)	529
XC60 I SUV (156)	529
XC60 I VAN (156)	530
XC70 I Cross Country (295)	530
XC70 II (136)	530
XC70 II VAN (136)	531
XC90 I (275)	531
XC90 I VAN (275)	532

VW**532**

AMAROK (2HA, 2HB, S1B, S6B, S7A, S7B)	532
AMAROK Pritsche/Fahrgestell (S1B, S6B, S7B)	532
ARTEON (3H7, 3H8)	532
ARTEON SHOOTING BRAKE (3H9)	533
BEETLE (5C1, 5C2)	533
BEETLE Cabriolet (5C7, 5C8)	533
BORA (9M2)	534
BORA I (1J2)	535
BORA Variant (1J6)	536
CADDY ALLTRACK Großraumlimousine (SAB)	540
CADDY ALLTRACK Kasten/Großraumlimousine (SAA)	540
CADDY II Großraumlimousine (9K9B)	537

**VW****532**

CADDY III Großraumlimousine (2KB, 2KJ, 2CB, 2CJ)	538
CADDY III Kasten/Großraumlimousine (2KA, 2KH, 2CA, 2CH)	538
CADDY II Kasten/Großraumlimousine (9K9A)	537
CADDY II Pick-up (9U7)	538
CADDY IV Großraumlimousine (SAB, SAJ)	539
CADDY IV Kasten/Großraumlimousine (SAA, SAH)	539
CADDY Kasten/Großraumlimousine (6K9, 9E7, 9E9)	541
CALIFORNIA T5 Camper (7EC, 7EF, 7EG, 7HF, 7HC)	541
CC B7 (358)	541
CRAFTER 30-35 Bus (2E_)	542
CRAFTER 30-50 Kasten (2E_)	542
CRAFTER 30-50 Pritsche/Fahrgestell (2F_)	542
EOS (1F7, 1F8)	543
FOX Schrägheck (5Z1, 5Z3, 5Z4)	543
FOX Van (5Z1)	543
GOLF ALLTRACK VII Variant (BA5, BV5)	554
GOLF IV (1J1)	543
GOLF IV (9B3)	545
GOLF IV Cabriolet (1E7)	546
GOLF IV Van (1J1)	546
GOLF IV Variant (1J5)	547
GOLF Kasten/Schrägheck (1K1)	554
GOLF PLUS V (5M1, 521)	554
GOLF PLUS Van (521)	558
GOLF SPORTSVAN VII (AM1, AN1)	560
GOLF V (1K1)	547
GOLF VAN IV Variant (1J5)	560
GOLF VAN VII Variant (BA5)	561
GOLF VAN VI Variant (AJ5)	560
GOLF VI (5K1)	550
GOLF VI Cabriolet (517)	551
GOLF VII (5G1, BQ1, BE1, BE2)	552
GOLF VII Van (5G1)	553
GOLF VII Variant (BA5, BV5)	553
GOLF VI Van (5K1_)	551
GOLF VI Variant (AJ5)	552
GOLF V Variant (1K5)	549
JETTA III (1K2)	561
JETTA IV (162, 163, AV3, AV2)	562
JETTA VII Stufenheck (BU3, BU4)	563
LOAD UP (121, 122, BL1, BL2)	563
LT 28-35 II Bus (2DB, 2DE, 2DK)	563
LT 28-46 II Kasten (2DA, 2DD, 2DH)	563
LT 28-46 II Pritsche/Fahrgestell (2DC, 2DF, 2DG, 2DL, 2DM)	564
LUPO I (6X1, 6E1)	564
MULTIVAN T5 (7HM, 7HN, 7HF, 7EF, 7EM, 7EN)	564
NEW BEETLE (9C1, 1C1)	565
NEW BEETLE Cabriolet (1Y7)	566
PASSAT ALLTRACK B7 (365)	567
PASSAT ALLTRACK B8 Variant (3G5, CB5)	567
PASSAT B5.5 (3B3)	567
PASSAT B5.5 Variant (3B6)	567
PASSAT B5 (3B2)	568
PASSAT B5 Variant (3B5)	569
PASSAT B6 (3C2)	569
PASSAT B6 Variant (3C5)	570
PASSAT B7 (362)	571
PASSAT B7 (A32, A33)	571
PASSAT B7 Kasten/Kombi (365)	572
PASSAT B7 Variant (365)	572
PASSAT B8 (3G2, CB2)	572
PASSAT B8 Variant (3G5, CB5)	573
PASSAT CC B6 (357)	573
POLO (6N2)	574
POLO III CLASSIC (6V2)	574
POLO IV (9N_, 9A_)	575
POLO IV Stufenheck (9A4, 9A2, 9N2, 9A6)	576
POLO IV Stufenheck (9N2, 9N4)	576
POLO Van Kasten/Kombi (6V5)	577
POLO Variant (6V5)	577
POLO VI (AW1, BZ1, AE1)	576
SCIROCCO III (137, 138)	577
SCIROCCO Van (137)	579

**VW****532**

SHARAN (7M8, 7M9, 7M6)	580
SHARAN (7N1, 7N2)	581
SHARAN VAN (7M_)	582
SHARAN VAN (7N1, 7N2)	582
TAIGO (CS1)	582
TAOS (CL1, CP1, CQ1)	582
TIGUAN (5N_)	582
TIGUAN (AD1, AX1)	583
TIGUAN Kasten/SUV (AD1)	583
TIGUAN VAN (5N_)	583
TOUAREG (7LA, 7L6, 7L7)	584
TOURAN (1T1, 1T2)	584
TOURAN (1T3)	585
TOURAN (5T1)	586
TOURAN VAN (1T1, 1T2)	586
TOURAN VAN (1T3)	586
TOURAN VAN (5T1)	587
TRANSPORTER T4 Bus (70B, 70C, 7DB, 7DK, 70J, 70K, 7DC, 7DJ)	587
TRANSPORTER T4 Kasten (70A, 70H, 7DA, 7DH)	588
TRANSPORTER T4 Pritsche/Fahrgestell (70E, 70L, 70M, 7DE, 7DL)	589
TRANSPORTER T5 Bus (7HB, 7HJ, 7EB, 7EJ)	590
TRANSPORTER T5 Kasten (7HA, 7HH, 7EA, 7EH)	591
TRANSPORTER T5 Pritsche/Fahrgestell (7JD, 7JE, 7JL, 7JY, 7JZ)	592
T-ROC (A11, D11)	593
T-ROC Cabriolet (AC7, AC8)	593
UP! (121, 122, BL1, BL2, BL3, 123)	593





- DE** Produktdetails
- EN** Product details
- ES** Descripción del producto
- FR** Présentation du produit
- IT** Panoramica prodotti

2025



03.0101-0027.2

320022



Bremskraftregler

Mengeneinheit: Satz

KenngroÙe: 3/45

Anschlussanzahl: 2

Bremssystem: ATE

03.0655-0002.2

370002



Pedalwegsensord, Bremspedal

Einbauposition: Bremskraftverstärker

Bremssystem: ATE

BMW

03.0655-0004.2

370004



Pedalwegsensord, Bremspedal

Einbauposition: Bremskraftverstärker

Bremssystem: ATE

VOLVO

03.0655-0005.2

370005



Pedalwegsensord, Bremspedal

Einbauposition: Bremskraftverstärker

Bremssystem: ATE

RENAULT, VOLVO

03.0655-0006.2

370006



Pedalwegsensord, Bremspedal

Einbauposition: Bremskraftverstärker

Bremssystem: ATE

AUDI, PORSCHE, SEAT, VW



03.0655-0007.2**370007****Pedalwegsensord, Bremspedal**

Einbauposition: Bremskraftverstärker

Bremsssystem: ATE

JAGUAR, MERCEDES-BENZ, RENAULT, VOLVO**03.0655-0101.2****370008****Drucksensord, Bremskraftverstärker**

Bremsssystem: ATE

AUDI, SEAT, SKODA, VW**03.2022-2624.3****010588****Hauptbremszylinder**

Durchmesser 1 [mm]: 22,2

Durchmesser 2 [mm]: 20,6

Anschlussanzahl: 2

MAPP-Code vorhanden:

Gewindemaß 1: 1x M10x1

Gewindemaß 2: 1x M12x1

Länge 1 [mm]: 33,3

Länge 2 [mm]: 113,2

BMW**03.2023-0825.3****010028****Hauptbremszylinder**

Durchmesser 1 [mm]: 23,8

Durchmesser 2 [mm]: 19

Gewindemaß: M10x1

Anschlussanzahl: 3

MAPP-Code vorhanden:

Länge 1 [mm]: 57,4

Länge 2 [mm]: 109,6

MERCEDES-BENZ

03.2023-1066.3**010032****Hauptbremszylinder**

Durchmesser 1 [mm]: 23,8

Durchmesser 2 [mm]: 19

Anschlussanzahl: 2

MAPP-Code vorhanden:

Gewindemaß 1: 1x M10x1

Gewindemaß 2: 1x M12x1

Länge 1 [mm]: 49,8

Länge 2 [mm]: 109

MERCEDES-BENZ**03.2023-1084.3****010591****Hauptbremszylinder**

Durchmesser 1 [mm]: 23,8

Durchmesser 2 [mm]: 20,6

Gewindemaß: M10x1

Anschlussanzahl: 3

MAPP-Code vorhanden:

Bremsystem: ATE

Länge 1 [mm]: 38,3

Länge 2 [mm]: 132,5

VOLVO**03.2023-1741.3****010703****Hauptbremszylinder**

Durchmesser 1 [mm]: 23,8

Durchmesser 2 [mm]: 20,6

Gewindemaß: M12x1

Anschlussanzahl: 4

MAPP-Code vorhanden:

Bremsystem: ATE

Länge 1 [mm]: 12

Länge 2 [mm]: 169,5

MERCEDES-BENZ**03.2023-1812.3****010570****Hauptbremszylinder**

Durchmesser 1 [mm]: 23,8

Durchmesser 2 [mm]: 19

Anschlussanzahl: 3

MAPP-Code vorhanden:

Gewindemaß 1: 1x M10x1

Gewindemaß 2: 2x M12x1

Länge 1 [mm]: 4

Länge 2 [mm]: 147

MERCEDES-BENZ

03.2023-2004.3

010788



Hauptbremszylinder

Durchmesser 1 [mm]: 23,8
Durchmesser 2 [mm]: 19
Gewindemaß: M12x1
Anschlussanzahl: 4
MAPP-Code vorhanden:
Bremsystem: ATE
Länge 1 [mm]: 4
Länge 2 [mm]: 147

MERCEDES-BENZ

03.2023-2204.3

010644



Hauptbremszylinder

Durchmesser 1 [mm]: 23,8
Durchmesser 2 [mm]: 22,2
Gewindemaß: M12x1
Anschlussanzahl: 5
MAPP-Code vorhanden:
Bremsystem: ATE
Länge 1 [mm]: 36,9
Länge 2 [mm]: 116,4

BMW

03.2023-2249.3

010869



Hauptbremszylinder

Durchmesser 1 [mm]: 23,8
Durchmesser 2 [mm]: 22,2
Gewindemaß: M12x1
Anschlussanzahl: 4
MAPP-Code vorhanden:
Bremsystem: ATE
Länge 1 [mm]: 35,9
Länge 2 [mm]: 116,4

BMW

03.2023-2256.3

010870



Hauptbremszylinder

Durchmesser 1 [mm]: 23,8
Durchmesser 2 [mm]: 22,2
Gewindemaß: M12x1
Anschlussanzahl: 2
MAPP-Code vorhanden:
Bremsystem: ATE
Länge 1 [mm]: 35,9
Länge 2 [mm]: 116,4

BMW

03.2023-2304.3**010646****Hauptbremszylinder**

Durchmesser 1 [mm]: 23,8

Durchmesser 2 [mm]: 22,2

Anschlussanzahl: 2

MAPP-Code vorhanden:

Bremsystem: ATE

Gewindemaß 1: 1x M10x1

Gewindemaß 2: 1x M12x1

Länge 1 [mm]: 32,8

Länge 2 [mm]: 113,2

BMW**03.2023-2344.3****010647****Hauptbremszylinder**

Durchmesser 1 [mm]: 23,8

Durchmesser 2 [mm]: 22,2

Anschlussanzahl: 2

MAPP-Code vorhanden:

Bremsystem: ATE

Gewindemaß 1: 1x M10x1

Gewindemaß 2: 1x M12x1

Länge 1 [mm]: 32,8

Länge 2 [mm]: 113,2

BMW**03.2023-2407.3****010796****Hauptbremszylinder**

Durchmesser 1 [mm]: 23,8

Durchmesser 2 [mm]: 22,2

Gewindemaß: M12x1

Anschlussanzahl: 2

MAPP-Code vorhanden:

Bremsystem: ATE

Länge 1 [mm]: 59,2

Länge 2 [mm]: 105,7

BMW**03.2025-0211.3****010034****Hauptbremszylinder**

Durchmesser 1 [mm]: 25,4

Durchmesser 2 [mm]: 19

Gewindemaß: M10x1

Anschlussanzahl: 3

MAPP-Code vorhanden:

Länge 1 [mm]: 57,8

Länge 2 [mm]: 108

MERCEDES-BENZ

03.2025-1741.3**010705****Hauptbremszylinder**

Durchmesser 1 [mm]: 25,4

Durchmesser 2 [mm]: 20,6

Gewindemaß: M12x1

Anschlussanzahl: 4

MAPP-Code vorhanden:

Bremsystem: ATE

Länge 1 [mm]: 12

Länge 2 [mm]: 169,5

MERCEDES-BENZ**03.2025-1904.3****010797****Hauptbremszylinder**

Durchmesser 1 [mm]: 25,4

Durchmesser 2 [mm]: 22,2

Gewindemaß: M12x1

Anschlussanzahl: 2

MAPP-Code vorhanden:

Bremsystem: ATE

Länge 1 [mm]: 59,2

Länge 2 [mm]: 105,7

BMW**03.2025-2521.3****010959****Hauptbremszylinder**

Durchmesser 1 [mm]: 25,4

Durchmesser 2 [mm]: 20,6

Gewindemaß: M12x1

Anschlussanzahl: 2

MAPP-Code vorhanden:

Bremsystem: ATE

Länge 1 [mm]: 57,6

Länge 2 [mm]: 114,3

MERCEDES-BENZ**03.2025-5826.3****010960****Hauptbremszylinder**

Durchmesser 1 [mm]: 25,4

Durchmesser 2 [mm]: 22,2

Gewindemaß: M12x1

Anschlussanzahl: 2

MAPP-Code vorhanden:

Bremsystem: ATE

Länge 1 [mm]: 35,9

Länge 2 [mm]: 116

BMW

03.2119-3391.3**010058****Hauptbremszylinder**

Durchmesser [mm]: 19

Gewindemaß: M10x1

Anschlussanzahl: 2

MAPP-Code vorhanden:

Bremsystem: ATE

Länge 1 [mm]: 40

Länge 2 [mm]: 114,9

PEUGEOT**03.2120-1897.3****010103****Hauptbremszylinder**

Durchmesser [mm]: 20,6

Gewindemaß: M10x1

Anschlussanzahl: 2

MAPP-Code vorhanden:

Bremsystem: ATE

Länge 1 [mm]: 40

Länge 2 [mm]: 114,9

PEUGEOT**03.2120-2031.3****010106****Hauptbremszylinder**

Durchmesser [mm]: 20,6

Gewindemaß: M10x1

Anschlussanzahl: 4

MAPP-Code vorhanden:

Bremsystem: ATE

Länge 1 [mm]: 32,4

Länge 2 [mm]: 114,9

RENAULT**03.2120-3943.3****010532****Hauptbremszylinder**

Durchmesser [mm]: 20,6

Gewindemaß: M10x1

Anschlussanzahl: 4

Material: Aluguss

MAPP-Code vorhanden:

Bremsystem: ATE

Länge 1 [mm]: 35,4

Länge 2 [mm]: 109,7

SEAT, VW

03.2120-4166.3**010452****Hauptbremszylinder**

Durchmesser [mm]: 20,6

Gewindemaß: M10x1

Anschlussanzahl: 4

MAPP-Code vorhanden:

Bremsystem: ATE

Länge 1 [mm]: 29,9

Länge 2 [mm]: 115,9

CITROËN, PEUGEOT**03.2120-4241.3****010524****Hauptbremszylinder**

Durchmesser [mm]: 20,6

Gewindemaß: M10x1

Anschlussanzahl: 2

MAPP-Code vorhanden:

Bremsystem: ATE

Länge 1 [mm]: 29,9

Länge 2 [mm]: 115,9

PEUGEOT**03.2120-4321.3****010525****Hauptbremszylinder**

Durchmesser [mm]: 20,6

Anschlussanzahl: 4

MAPP-Code vorhanden:

Bremsystem: ATE

Gewindemaß 1: 2x M10x1

Gewindemaß 2: 2x M12x1

Länge 1 [mm]: 29,9

Länge 2 [mm]: 115,9

PEUGEOT**03.2120-4381.3****010526****Hauptbremszylinder**

Durchmesser [mm]: 20,6

Anschlussanzahl: 4

MAPP-Code vorhanden:

Bremsystem: ATE

Gewindemaß 1: 2x M10x1

Gewindemaß 2: 2x M12x1

Länge 1 [mm]: 29,9

Länge 2 [mm]: 124,7

RENAULT

03.2120-4461.3**010571****Hauptbremszylinder**

Durchmesser [mm]: 20,6

Anschlussanzahl: 2

MAPP-Code vorhanden:

Bremsssystem: ATE

Gewindemaß 1: 1x M10x1

Gewindemaß 2: 1x M12x1

Länge 1 [mm]: 31,5

Länge 2 [mm]: 124,7

RENAULT**03.2120-4468.3****010789****Hauptbremszylinder**

Durchmesser [mm]: 20,6

Gewindemaß: M12x1

Anschlussanzahl: 2

MAPP-Code vorhanden:

Bremsssystem: ATE

Länge 1 [mm]: 31,5

Länge 2 [mm]: 124,7

RENAULT**03.2120-4581.3****010915****Hauptbremszylinder**

Durchmesser [mm]: 20,6

Anschlussanzahl: 2

MAPP-Code vorhanden:

Bremsssystem: ATE

Gewindemaß 1: M10x1

Gewindemaß 2: M12x1

Länge 1 [mm]: 31,5

Länge 2 [mm]: 162,5

RENAULT**03.2120-4611.3****010937****Hauptbremszylinder**

Durchmesser [mm]: 20,6

Gewindemaß: M10x1

Anschlussanzahl: 2

MAPP-Code vorhanden:

Bremsssystem: ATE

Länge 1 [mm]: 22,5

Länge 2 [mm]: 133

DACIA, RENAULT

03.2120-4641.3**010932****Hauptbremszylinder**

Durchmesser [mm]: 20,6

Gewindemaß: M12x1

Anschlussanzahl: 2

MAPP-Code vorhanden:

Bremsystem: ATE

Länge 1 [mm]: 31,5

Länge 2 [mm]: 124,7

RENAULT**03.2122-0264.3****010129****Hauptbremszylinder**

Durchmesser [mm]: 22,2

Anschlussanzahl: 4

MAPP-Code vorhanden:

Bremsystem: ATE

Gewindemaß 1: 2x M10x1

Gewindemaß 2: 2x M12x1

Länge 1 [mm]: 33,1

Länge 2 [mm]: 118

OPEL**03.2122-1001.3****010562****Hauptbremszylinder**

Durchmesser [mm]: 22,2

Anschlussanzahl: 4

MAPP-Code vorhanden:

Gewindemaß 1: 2x M10x1

Gewindemaß 2: 2x M12x1

Länge 1 [mm]: 27,9

Länge 2 [mm]: 131,7

RENAULT**03.2122-1042.3****010137****Hauptbremszylinder**

Durchmesser [mm]: 22,2

Gewindemaß: M10x1

Anschlussanzahl: 4

MAPP-Code vorhanden:

Länge 1 [mm]: 36

Länge 2 [mm]: 109,7

SEAT, VW

03.2122-1144.3

010636



Hauptbremszylinder

Durchmesser [mm]: 22,2

Gewindemaß: M10x1

Anschlussanzahl: 2

MAPP-Code vorhanden:

Bremssystem: ATE

Länge 1 [mm]: 36

Länge 2 [mm]: 109,7

VW

03.2122-1344.3

010593



Hauptbremszylinder

Durchmesser [mm]: 22,2

Gewindemaß: M10x1

Anschlussanzahl: 2

MAPP-Code vorhanden:

Bremssystem: ATE

Länge 1 [mm]: 31,5

Länge 2 [mm]: 119,6

SEAT, VW

03.2122-1351.3

010528



Hauptbremszylinder

Durchmesser [mm]: 22,2

Anschlussanzahl: 2

MAPP-Code vorhanden:

Gewindemaß 1: 1x M10x1

Gewindemaß 2: 1x M12x1

Länge 1 [mm]: 31,5

Länge 2 [mm]: 115,9

CITROËN, PEUGEOT

03.2122-1356.3

010529



Hauptbremszylinder

Durchmesser [mm]: 22,2

Anschlussanzahl: 4

MAPP-Code vorhanden:

Gewindemaß 1: 2x M10x1

Gewindemaß 2: 2x M12x1

Länge 1 [mm]: 27,9

Länge 2 [mm]: 115,9

CITROËN, PEUGEOT

03.2122-1461.3**010610****Hauptbremszylinder**

Durchmesser [mm]: 22,2

Gewindemaß: M10x1

Anschlussanzahl: 2

MAPP-Code vorhanden:

Bremsystem: ATE

Länge 1 [mm]: 31,5

Länge 2 [mm]: 109,4

PEUGEOT**03.2122-1541.3****010511****Hauptbremszylinder**

Durchmesser [mm]: 22,2

Gewindemaß: M10x1

Anschlussanzahl: 4

MAPP-Code vorhanden:

Länge 1 [mm]: 27,4

Länge 2 [mm]: 119

RENAULT**03.2122-1824.3****010892****Hauptbremszylinder**

Durchmesser [mm]: 22,2

Gewindemaß: M12x1

Anschlussanzahl: 3

MAPP-Code vorhanden:

Bremsystem: ATE

Länge 1 [mm]: 42,1

Länge 2 [mm]: 109,3

MINI**03.2122-1853.3****010893****Hauptbremszylinder**

Durchmesser [mm]: 22,2

Gewindemaß: M12x1

Anschlussanzahl: 2

MAPP-Code vorhanden:

Bremsystem: ATE

Länge 1 [mm]: 40,9

Länge 2 [mm]: 109,3

MINI

03.2122-1888.3**010736****Hauptbremszylinder**

Durchmesser [mm]: 22,2

Gewindemaß: M12x1

Anschlussanzahl: 3

MAPP-Code vorhanden:

Bremsystem: ATE

Länge 1 [mm]: 6,4

Länge 2 [mm]: 143,3

AUDI**03.2122-1926.3****010916****Hauptbremszylinder**

Durchmesser [mm]: 22,2

Gewindemaß: M12x1

Anschlussanzahl: 2

MAPP-Code vorhanden:

Bremsystem: ATE

Länge 1 [mm]: 30,5

Länge 2 [mm]: 125,7

RENAULT**03.2122-1942.3****010700****Hauptbremszylinder**

Durchmesser [mm]: 22,2

Gewindemaß: M12x1

Anschlussanzahl: 3

MAPP-Code vorhanden:

Bremsystem: ATE

Länge 1 [mm]: 30,5

Länge 2 [mm]: 117,7

PEUGEOT**03.2122-2031.3****010938****Hauptbremszylinder**

Durchmesser [mm]: 22,2

Gewindemaß: M12x1

Anschlussanzahl: 2

MAPP-Code vorhanden:

Bremsystem: ATE

Länge 1 [mm]: 22,5

Länge 2 [mm]: 132

DACIA, RENAULT

03.2122-2129.3**010799****Hauptbremszylinder**

Durchmesser [mm]: 22,2

Gewindemaß: M12x1

Anschlussanzahl: 2

MAPP-Code vorhanden:

Bremsystem: ATE

Länge 1 [mm]: 36,1

Länge 2 [mm]: 134,9

AUDI, SEAT, SKODA, VW**03.2122-2163.3****010800****Hauptbremszylinder**

Durchmesser [mm]: 22,2

Gewindemaß: M12x1

Anschlussanzahl: 3

MAPP-Code vorhanden:

Bremsystem: ATE

Länge 1 [mm]: 39,8

Länge 2 [mm]: 128,2

CITROËN, FIAT, LANCIA, PEUGEOT**03.2122-2261.3****010964****Hauptbremszylinder**

Durchmesser [mm]: 22,2

Gewindemaß: M12x1

Anschlussanzahl: 2

MAPP-Code vorhanden:

Bremsystem: ATE

Länge 1 [mm]: 21,5

Länge 2 [mm]: 144,4

DACIA, RENAULT**03.2123-1121.3****010176****Hauptbremszylinder**

Durchmesser [mm]: 23,8

Anschlussanzahl: 2

MAPP-Code vorhanden:

Gewindemaß 1: 1x M10x1

Gewindemaß 2: 1x M12x1

Länge 1 [mm]: 29,1

Länge 2 [mm]: 118

SAAB

03.2123-1424.3**010637****Hauptbremszylinder**

Durchmesser [mm]: 23,8

Gewindemaß: M10x1

Anschlussanzahl: 2

MAPP-Code vorhanden:

Bremsystem: ATE

Länge 1 [mm]: 34,4

Länge 2 [mm]: 116,6

SEAT, VW**03.2123-1484.3****010595****Hauptbremszylinder**

Durchmesser [mm]: 23,8

Gewindemaß: M12x1

Anschlussanzahl: 2

MAPP-Code vorhanden:

Bremsystem: ATE

Länge 1 [mm]: 31,5

Länge 2 [mm]: 119,6

SEAT, VW**03.2123-1486.3****010488****Hauptbremszylinder**

Durchmesser [mm]: 23,8

Gewindemaß: M12x1

Anschlussanzahl: 2

MAPP-Code vorhanden:

Länge 1 [mm]: 31,5

Länge 2 [mm]: 119,6

RENAULT**03.2123-1526.3****010477****Hauptbremszylinder**

Durchmesser [mm]: 23,8

Gewindemaß: M12x1

Anschlussanzahl: 2

MAPP-Code vorhanden:

Länge 1 [mm]: 31,5

Länge 2 [mm]: 119,6

FORD, SEAT, VW

03.2123-1548.3**010478****Hauptbremszylinder**

Durchmesser [mm]: 23,8

Gewindemaß: M10x1

Anschlussanzahl: 4

MAPP-Code vorhanden:

Länge 1 [mm]: 27,9

Länge 2 [mm]: 114,1

FORD, SEAT, VW**03.2123-1551.3****010512****Hauptbremszylinder**

Durchmesser [mm]: 23,8

Gewindemaß: M10x1

Anschlussanzahl: 4

MAPP-Code vorhanden:

Länge 1 [mm]: 27,9

Länge 2 [mm]: 114,1

RENAULT**03.2123-1581.3****010487****Hauptbremszylinder**

Durchmesser [mm]: 23,8

Gewindemaß: M12x1

Anschlussanzahl: 2

MAPP-Code vorhanden:

Länge 1 [mm]: 33,1

Länge 2 [mm]: 125,8

FORD**03.2123-1622.3****010470****Hauptbremszylinder**

Durchmesser [mm]: 23,8

Anschlussanzahl: 3

MAPP-Code vorhanden:

Gewindemaß 1: 1x M10x1

Gewindemaß 2: 2x M12x1

Länge 1 [mm]: 31,5

Länge 2 [mm]: 119,6

OPEL, VAUXHALL

03.2123-1626.3**010727****Hauptbremszylinder**

Durchmesser [mm]: 23,8

Anschlussanzahl: 3

MAPP-Code vorhanden:

Bremsystem: ATE

Gewindemaß 1: 1x M10x1

Gewindemaß 2: 2x M12x1

Länge 1 [mm]: 31,5

Länge 2 [mm]: 119,6

SAAB**03.2123-1741.3****010537****Hauptbremszylinder**

Durchmesser [mm]: 23,8

Gewindemaß: M10x1

Anschlussanzahl: 4

MAPP-Code vorhanden:

Bremsystem: ATE

Länge 1 [mm]: 27,9

Länge 2 [mm]: 113,1

RENAULT**03.2123-1824.3****010596****Hauptbremszylinder**

Durchmesser [mm]: 23,8

Gewindemaß: M10x1

Anschlussanzahl: 2

MAPP-Code vorhanden:

Bremsystem: ATE

Länge 1 [mm]: 31,5

Länge 2 [mm]: 119,6

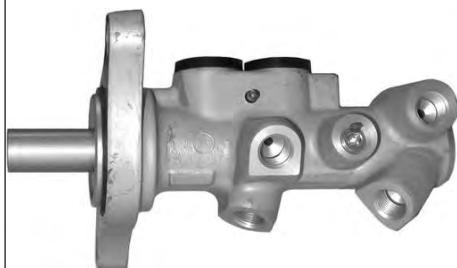
VW**03.2123-2024.3****010597****Hauptbremszylinder**

Durchmesser [mm]: 23,8

Anschlussanzahl: 4

MAPP-Code vorhanden:

Bremsystem: ATE

Gewindemaß 1: 2x M10x1

Gewindemaß 2: 2x M12x1

Länge 1 [mm]: 4,1

Länge 2 [mm]: 137,8

AUDI, SEAT, SKODA, VW

03.2123-2146.3**010572****Hauptbremszylinder**

Durchmesser [mm]: 23,8

Gewindemaß: M10x1

Anschlussanzahl: 2

MAPP-Code vorhanden:

Länge 1 [mm]: 31,5

Länge 2 [mm]: 119

RENAULT**03.2123-2164.3****010599****Hauptbremszylinder**

Durchmesser [mm]: 23,8

Gewindemaß: M12x1

Anschlussanzahl: 2

MAPP-Code vorhanden:

Bremsystem: ATE

Länge 1 [mm]: 40,3

Länge 2 [mm]: 130

VOLVO**03.2123-2243.3****010748****Hauptbremszylinder**

Durchmesser [mm]: 23,8

Gewindemaß: M12x1

Anschlussanzahl: 2

MAPP-Code vorhanden:

Bremsystem: ATE

Länge 1 [mm]: 26,5

Länge 2 [mm]: 124

FORD**03.2123-2581.3****010613****Hauptbremszylinder**

Durchmesser [mm]: 23,8

Gewindemaß: M12x1

Anschlussanzahl: 2

MAPP-Code vorhanden:

Bremsystem: ATE

Länge 1 [mm]: 31,5

Länge 2 [mm]: 119,6

PEUGEOT

03.2123-2621.3**010701****Hauptbremszylinder**

Durchmesser [mm]: 23,8

Gewindemaß: M12x1

Anschlussanzahl: 2

MAPP-Code vorhanden:

Bremsystem: ATE

Länge 1 [mm]: 30,5

Länge 2 [mm]: 124,8

RENAULT**03.2123-2715.3****010802****Hauptbremszylinder**

Durchmesser [mm]: 23,8

Gewindemaß: M12x1

Anschlussanzahl: 3

MAPP-Code vorhanden:

Bremsystem: ATE

Länge 1 [mm]: 34,9

Länge 2 [mm]: 121,4

AUDI, SEAT, SKODA, VW**03.2123-2751.3****011014****Hauptbremszylinder**

Durchmesser [mm]: 23,8

Gewindemaß: M12x1

Anschlussanzahl: 2

MAPP-Code vorhanden:

Bremsystem: ATE

Länge 1 [mm]: 28,2

Länge 2 [mm]: 119

RENAULT**03.2123-2761.3****010886****Hauptbremszylinder**

Durchmesser [mm]: 23,8

Gewindemaß: M12x1

Anschlussanzahl: 2

MAPP-Code vorhanden:

Bremsystem: ATE

Länge 1 [mm]: 30,5

Länge 2 [mm]: 123,7

CITROËN

03.2123-2774.3**010803****Hauptbremszylinder**

Durchmesser [mm]: 23,8

Gewindemaß: M12x1

Anschlussanzahl: 4

MAPP-Code vorhanden:

Bremsystem: ATE

Länge 1 [mm]: 26,6

Länge 2 [mm]: 130,2

AUDI, SEAT, SKODA, VW**03.2123-2781.3****010631****Hauptbremszylinder**

Durchmesser [mm]: 23,8

Anschlussanzahl: 4

MAPP-Code vorhanden:

Bremsystem: ATE

Gewindemaß 1: 2x M10x1

Gewindemaß 2: 2x M12x1

Länge 1 [mm]: 27,9

Länge 2 [mm]: 119,6

CITROËN, PEUGEOT**03.2123-2821.3****010944****Hauptbremszylinder**

Durchmesser [mm]: 23,8

Gewindemaß: M10x1

Anschlussanzahl: 4

MAPP-Code vorhanden:

Bremsystem: ATE

Länge 1 [mm]: 30,7

Länge 2 [mm]: 110

RENAULT**03.2123-2923.3****010791****Hauptbremszylinder**

Durchmesser [mm]: 23,8

Gewindemaß: M12x1

Anschlussanzahl: 2

MAPP-Code vorhanden:

Bremsystem: ATE

Länge 1 [mm]: 28,2

Länge 2 [mm]: 119

NISSAN, RENAULT

03.2123-2973.3**010951****Hauptbremszylinder**

Durchmesser [mm]: 23,8

Gewindemaß: M12x1

Anschlussanzahl: 2

MAPP-Code vorhanden:

Bremsystem: ATE

Länge 1 [mm]: 34,9

Länge 2 [mm]: 120,4

SKODA**03.2123-3103.3****010781****Hauptbremszylinder**

Durchmesser [mm]: 23,8

Gewindemaß: M12x1

Anschlussanzahl: 2

MAPP-Code vorhanden:

Bremsystem: ATE

Länge 1 [mm]: 37

Länge 2 [mm]: 116,3

FORD**03.2123-3241.3****010882****Hauptbremszylinder**

Durchmesser [mm]: 23,8

Gewindemaß: M10x1

Anschlussanzahl: 2

MAPP-Code vorhanden:

Bremsystem: ATE

Länge 1 [mm]: 29,2

Länge 2 [mm]: 116

RENAULT**03.2123-3421.3****010933****Hauptbremszylinder**

Durchmesser [mm]: 23,8

Gewindemaß: M12x1

Anschlussanzahl: 2

MAPP-Code vorhanden:

Bremsystem: ATE

Länge 1 [mm]: 39,8

Länge 2 [mm]: 128,2

CITROËN, PEUGEOT

03.2123-3449.3**010808****Hauptbremszylinder**

Durchmesser [mm]: 23,8

Gewindemaß: M12x1

Anschlussanzahl: 2

MAPP-Code vorhanden:

Bremsystem: ATE

Länge 1 [mm]: 36,1

Länge 2 [mm]: 134,9

AUDI, SEAT, SKODA, VW**03.2123-3493.3****010792****Hauptbremszylinder**

Durchmesser [mm]: 23,8

Gewindemaß: M12x1

Anschlussanzahl: 2

MAPP-Code vorhanden:

Bremsystem: ATE

Länge 1 [mm]: 28,2

Länge 2 [mm]: 119

RENAULT**03.2123-3549.3****010809****Hauptbremszylinder**

Durchmesser [mm]: 23,8

Gewindemaß: M12x1

Anschlussanzahl: 2

MAPP-Code vorhanden:

Bremsystem: ATE

Länge 1 [mm]: 36,1

Länge 2 [mm]: 134,9

AUDI**03.2123-3571.3****010962****Hauptbremszylinder**

Durchmesser [mm]: 23,8

Gewindemaß: M10x1

Anschlussanzahl: 2

MAPP-Code vorhanden:

Bremsystem: ATE

Länge 1 [mm]: 35,2

Länge 2 [mm]: 132,8

ALFA ROMEO

03.2123-3593.3**010919****Hauptbremszylinder**

Durchmesser [mm]: 23,8

Gewindemaß: M12x1

Anschlussanzahl: 2

MAPP-Code vorhanden:

Bremsystem: ATE

Länge 1 [mm]: 37

Länge 2 [mm]: 116,3

VOLVO**03.2123-3624.3****010956****Hauptbremszylinder**

Durchmesser [mm]: 23,8

Gewindemaß: M12x1

Anschlussanzahl: 2

MAPP-Code vorhanden:

Bremsystem: ATE

Länge 1 [mm]: 37

Länge 2 [mm]: 116,3

VOLVO**03.2123-3641.3****010963****Hauptbremszylinder**

Durchmesser [mm]: 23,8

Gewindemaß: M10x1

Anschlussanzahl: 2

MAPP-Code vorhanden:

Bremsystem: ATE

Länge 1 [mm]: 36,2

Länge 2 [mm]: 127,8

PEUGEOT**03.2125-0161.3****010920****Hauptbremszylinder**

Durchmesser [mm]: 25,4

Gewindemaß: M10x1

Anschlussanzahl: 2

MAPP-Code vorhanden:

Bremsystem: ATE

Länge 1 [mm]: 9

Länge 2 [mm]: 142

NISSAN

03.2125-0332.3**010952****Hauptbremszylinder**

Durchmesser [mm]: 25,4

Gewindemaß: M12x1

Anschlussanzahl: 2

MAPP-Code vorhanden:

Länge 1 [mm]: 38,2

Länge 2 [mm]: 108

FORD, SEAT, VW**03.2125-0373.3****010810****Hauptbremszylinder**

Durchmesser [mm]: 25,4

Gewindemaß: M12x1

Anschlussanzahl: 2

MAPP-Code vorhanden:

Bremsystem: ATE

Länge 1 [mm]: 64,2

Länge 2 [mm]: 93,5

AUDI, SEAT, SKODA, VW**03.2125-0421.3****010934****Hauptbremszylinder**

Durchmesser [mm]: 25,4

Gewindemaß: M12x1

Anschlussanzahl: 2

MAPP-Code vorhanden:

Bremsystem: ATE

Länge 1 [mm]: 64,2

Länge 2 [mm]: 93,5

CHEVROLET, OPEL, SAAB, VAUXHALL**03.2125-0483.3****010783****Hauptbremszylinder**

Durchmesser [mm]: 25,4

Gewindemaß: M12x1

Anschlussanzahl: 2

MAPP-Code vorhanden:

Bremsystem: ATE

Ergänzungsartikel/Ergänzende Info 2: ohne Bremsflüssigkeitsbehälter

Länge 1 [mm]: 37

Länge 2 [mm]: 117,5

FORD, MAZDA

03.2125-0493.3**010940****Hauptbremszylinder**

Durchmesser [mm]: 25,4

Gewindemaß: M12x1

Anschlussanzahl: 2

MAPP-Code vorhanden:

Bremsystem: ATE

Länge 1 [mm]: 64,2

Länge 2 [mm]: 93,4

AUDI**03.2125-0531.3****010945****Hauptbremszylinder**

Durchmesser [mm]: 25,4

Gewindemaß: M12x1

Anschlussanzahl: 4

MAPP-Code vorhanden:

Bremsystem: ATE

Länge 1 [mm]: 9

Länge 2 [mm]: 142

NISSAN**03.2125-0651.3****010935****Hauptbremszylinder**

Durchmesser [mm]: 25,4

Gewindemaß: M14x1

Anschlussanzahl: 2

MAPP-Code vorhanden:

Bremsystem: ATE

Länge 1 [mm]: 46,6

Länge 2 [mm]: 107,9

FORD**03.2125-0661.3****010917****Hauptbremszylinder**

Durchmesser [mm]: 25,4

Gewindemaß: M14x1

Anschlussanzahl: 2

MAPP-Code vorhanden:

Bremsystem: ATE

Länge 1 [mm]: 37

Länge 2 [mm]: 117,5

FORD

03.2125-0671.3**010965****Hauptbremszylinder**

Durchmesser [mm]: 25,4

Gewindemaß: M12x1

Anschlussanzahl: 2

MAPP-Code vorhanden:

Bremsystem: ATE

Länge 1 [mm]: 35,2

Länge 2 [mm]: 133,8

CITROËN, FIAT, PEUGEOT**03.2125-0676.3****011009****Hauptbremszylinder**

Durchmesser [mm]: 25,4

Gewindemaß: M10x1

Anschlussanzahl: 2

MAPP-Code vorhanden:

Bremsystem: ATE

Ergänzungsartikel/Ergänzende Info 2: ohne Bremsflüssigkeitsbehälter

Länge 1 [mm]: 35,2

Länge 2 [mm]: 133,8

CITROËN, FIAT, PEUGEOT**03.2125-2102.3****010207****Hauptbremszylinder**

Durchmesser [mm]: 25,4

Gewindemaß: M10x1

Anschlussanzahl: 2

MAPP-Code vorhanden:

Länge 1 [mm]: 18,5

Länge 2 [mm]: 158,5

MERCEDES-BENZ**03.2125-5016.3****011010****Hauptbremszylinder**

Durchmesser [mm]: 25,4

Gewindemaß: M12x1

Anschlussanzahl: 2

MAPP-Code vorhanden:

Bremsystem: ATE

Länge 1 [mm]: 18,6

Länge 2 [mm]: 136,2

VOLVO

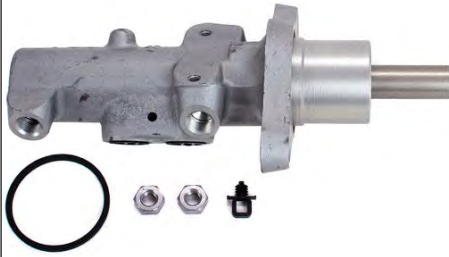
03.2125-5112.3**010966****Hauptbremszylinder**

Durchmesser [mm]: 25,4

Gewindemaß: M10x1

Anschlussanzahl: 2

MAPP-Code vorhanden:

Bremsystem: ATE

Länge 1 [mm]: 36,1

Länge 2 [mm]: 136,1

AUDI**03.2125-7310.3****010743****Hauptbremszylinder**

Durchmesser [mm]: 25,4

Gewindemaß: M12x1

Anschlussanzahl: 2

MAPP-Code vorhanden:

Bremsystem: ATE

Länge 1 [mm]: 11,6

Länge 2 [mm]: 141

MERCEDES-BENZ**03.2125-7637.3****010707****Hauptbremszylinder**

Durchmesser [mm]: 25,4

Gewindemaß: M12x1

Anschlussanzahl: 2

MAPP-Code vorhanden:

Bremsystem: ATE

Länge 1 [mm]: 11,6

Länge 2 [mm]: 140,7

VOLVO**03.2125-7638.3****010738****Hauptbremszylinder**

Durchmesser [mm]: 25,4

Gewindemaß: M12x1

Anschlussanzahl: 2

MAPP-Code vorhanden:

Bremsystem: ATE

Länge 1 [mm]: 11,6

Länge 2 [mm]: 140,7

VOLVO

03.2125-7708.3**010739****Hauptbremszylinder**

Durchmesser [mm]: 25,4

Gewindemaß: M12x1

Anschlussanzahl: 4

MAPP-Code vorhanden:

Bremsystem: ATE

Länge 1 [mm]: 11,6

Länge 2 [mm]: 140,7

VOLVO**03.2125-7713.3****010819****Hauptbremszylinder**

Durchmesser [mm]: 25,4

Gewindemaß: M12x1

Anschlussanzahl: 4

MAPP-Code vorhanden:

Bremsystem: ATE

Länge 1 [mm]: 11,6

Länge 2 [mm]: 140,7

VOLVO**03.2125-7743.3****010921****Hauptbremszylinder**

Durchmesser [mm]: 25,4

Gewindemaß: M12x1

Anschlussanzahl: 2

MAPP-Code vorhanden:

Bremsystem: ATE

Länge 1 [mm]: 11,6

Länge 2 [mm]: 141

VOLVO**03.2125-8111.3****010479****Hauptbremszylinder**

Durchmesser [mm]: 25,4

Gewindemaß: M10x1

Anschlussanzahl: 4

MAPP-Code vorhanden:

Länge 1 [mm]: 31,5

Länge 2 [mm]: 120,8

VW

03.2125-8404.3**010583****Hauptbremszylinder**

Durchmesser [mm]: 25,4

Gewindemaß: M10x1

Anschlussanzahl: 4

MAPP-Code vorhanden:

Bremsystem: ATE

Länge 1 [mm]: 34,6

Länge 2 [mm]: 108

FORD, SEAT, VW**03.2125-9604.3****010581****Hauptbremszylinder**

Durchmesser [mm]: 25,4

Gewindemaß: M10x1

Anschlussanzahl: 5

MAPP-Code vorhanden:

Länge 1 [mm]: 14,6

Länge 2 [mm]: 131,5

FORD, SEAT, VW**03.2125-9704.3****010603****Hauptbremszylinder**

Durchmesser [mm]: 25,4

Gewindemaß: M12x1

Anschlussanzahl: 2

MAPP-Code vorhanden:

Bremsystem: ATE

Länge 1 [mm]: 32,9

Länge 2 [mm]: 125,5

VW**03.2126-3014.3****010811****Hauptbremszylinder**

Durchmesser [mm]: 27

Gewindemaß: M12x1

Anschlussanzahl: 2

MAPP-Code vorhanden:

Bremsystem: ATE

Länge 1 [mm]: 18,7

Länge 2 [mm]: 133,5

PORSCHE, VW

03.2126-3063.3**010812****Hauptbremszylinder**

Durchmesser [mm]: 27
 Gewindemaß: M12x1
 Anschlussanzahl: 2
 MAPP-Code vorhanden:
 Bremssystem: ATE
 Länge 1 [mm]: 23,3
 Länge 2 [mm]: 128,9

AUDI**03.2126-3121.3****010967****Hauptbremszylinder**

Durchmesser [mm]: 27
 Gewindemaß: M12x1
 Anschlussanzahl: 2
 MAPP-Code vorhanden:
 Bremssystem: ATE
 Länge 1 [mm]: 37,2
 Länge 2 [mm]: 135,6

RENAULT**03.2126-3144.3****010941****Hauptbremszylinder**

Durchmesser [mm]: 27
 Gewindemaß: M12x1
 Anschlussanzahl: 2
 MAPP-Code vorhanden:
 Bremssystem: ATE
 Länge 1 [mm]: 31,1
 Länge 2 [mm]: 133,5

VW**03.2126-3196.3****010968****Hauptbremszylinder**

Durchmesser [mm]: 27
 Gewindemaß: M12x1
 Anschlussanzahl: 2
 MAPP-Code vorhanden:
 Bremssystem: ATE
 Länge 1 [mm]: 55,5
 Länge 2 [mm]: 114,3

MERCEDES-BENZ

03.2126-5132.3**011012****Hauptbremszylinder**

Durchmesser [mm]: 27
 Gewindemaß: M12x1
 Anschlussanzahl: 2
 Bremssystem: ATE
 Länge 1 [mm]: 37,2
 Länge 2 [mm]: 139,8

VW**03.2128-1203.3****010922****Hauptbremszylinder**

Durchmesser [mm]: 28,6
 Anschlussanzahl: 2
 MAPP-Code vorhanden:
 Bremssystem: ATE
 Gewindemaß 1: M10x1
 Gewindemaß 2: M14x1,5
 Länge 1 [mm]: 18,5
 Länge 2 [mm]: 204,5

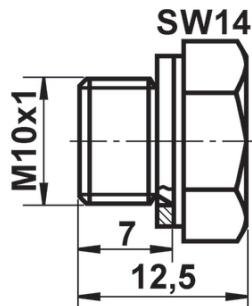
MERCEDES-BENZ**03.3517-0101.2****390322****Verschlusschraube, Hauptbremszylinder**

Länge über Alles [mm]: 12,5
 Gewindemaß: M10x1
 Länge [mm]: 7,5
 Schlüsselweite 1 [mm]: 14

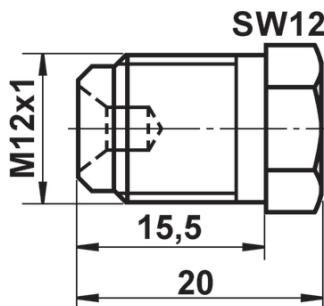
AUDI, SEAT, VW**03.3517-0300.1****390323****Verschlusschraube, Hauptbremszylinder**

Länge über Alles [mm]: 20
 Gewindemaß: M12x1
 Länge [mm]: 13
 Schlüsselweite 1 [mm]: 12
 Bördelform: E / F

RENAULT

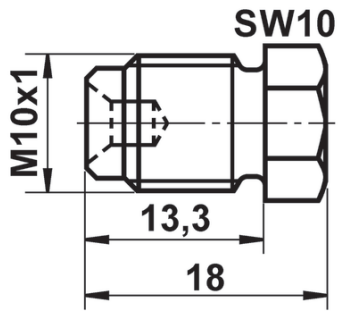
03.3517-5100.1**390326****Verschlusschraube, Hauptbremszylinder**

Länge über Alles [mm]: 18

Gewindemaß: M10x1

Länge [mm]: 11,5

Schlüsselweite 1 [mm]: 10

Bördelform: E / F

FORD, SEAT, VW**03.4055-0013.3****010793****Hauptbremszylinder**

Durchmesser [mm]: 25,4

Gewindemaß: M12x1

Anschlussanzahl: 2

MAPP-Code vorhanden:

Bremsssystem: ATE

Länge 1 [mm]: 20

Länge 2 [mm]: 106

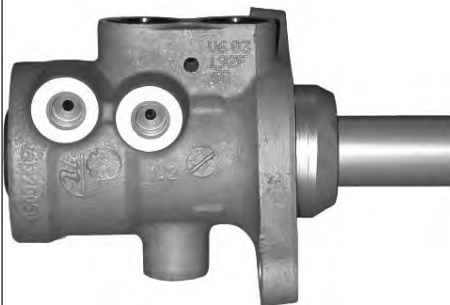
MERCEDES-BENZ**03.4122-0031.3****010611****Hauptbremszylinder**

Durchmesser [mm]: 22,2

Gewindemaß: M10x1

Anschlussanzahl: 4

MAPP-Code vorhanden:

Bremsssystem: ATE

Länge 1 [mm]: 14

Länge 2 [mm]: 85,1

PEUGEOT**03.4122-0054.3****010813****Hauptbremszylinder**

Durchmesser [mm]: 22,2

Gewindemaß: M12x1

Anschlussanzahl: 2

MAPP-Code vorhanden:

Bremsssystem: ATE

Länge 1 [mm]: 13,7

Länge 2 [mm]: 87,9

PEUGEOT

03.4123-0081.3**010585****Hauptbremszylinder**

Durchmesser [mm]: 23,8

Gewindemaß: M12x1

Anschlussanzahl: 3

MAPP-Code vorhanden:

Bremsystem: ATE

Länge 1 [mm]: 5,5

Länge 2 [mm]: 102,3

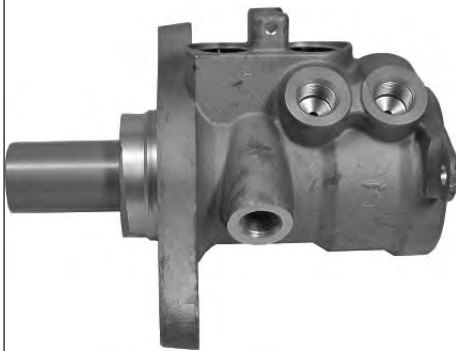
RENAULT**03.4123-0153.3****010659****Hauptbremszylinder**

Durchmesser [mm]: 23,8

Gewindemaß: M12x1

Anschlussanzahl: 3

MAPP-Code vorhanden:

Bremsystem: ATE

Länge 1 [mm]: 12,8

Länge 2 [mm]: 90,3

FORD**03.4125-0014.3****010794****Hauptbremszylinder**

Durchmesser [mm]: 25,4

Gewindemaß: M12x1

Anschlussanzahl: 3

MAPP-Code vorhanden:

Bremsystem: ATE

Länge 1 [mm]: 4,2

Länge 2 [mm]: 105

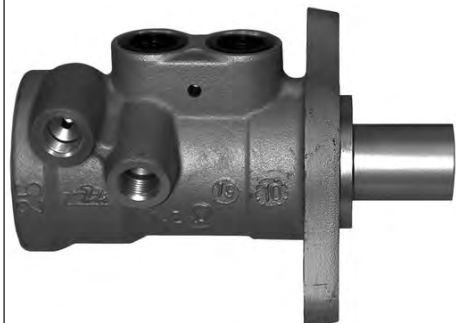
RENAULT**03.4125-0021.3****010888****Hauptbremszylinder**

Durchmesser [mm]: 25,4

Gewindemaß: M12x1

Anschlussanzahl: 2

MAPP-Code vorhanden:

Bremsystem: ATE

Länge 1 [mm]: 4,2

Länge 2 [mm]: 105

RENAULT

03.4152-0116.3**010814****Hauptbremszylinder**

Durchmesser [mm]: 22,2

Gewindemaß: M12x1

Anschlussanzahl: 2

MAPP-Code vorhanden:

Bremsystem: ATE

Länge 1 [mm]: 27,1

Länge 2 [mm]: 117

VW**03.4152-0153.3****011006****Hauptbremszylinder**

Durchmesser [mm]: 22,2

Gewindemaß: M10x1

Anschlussanzahl: 2

MAPP-Code vorhanden:

Bremsystem: ATE

Ergänzungsartikel/Ergänzende Info 2: ohne Bremsflüssigkeitsbehälter

Länge 1 [mm]: 27,9

Länge 2 [mm]: 91

DAIHATSU, TOYOTA**03.4152-0158.3****011007****Hauptbremszylinder**

Durchmesser [mm]: 22,2

Gewindemaß: M12x1

Anschlussanzahl: 2

MAPP-Code vorhanden:

Bremsystem: ATE

Ergänzungsartikel/Ergänzende Info 2: ohne Bremsflüssigkeitsbehälter

Länge 1 [mm]: 27,9

Länge 2 [mm]: 91

DAIHATSU, TOYOTA**03.4153-0015.3****011005****Hauptbremszylinder**

Durchmesser [mm]: 23,8

Anschlussanzahl: 4

MAPP-Code vorhanden:

Bremsystem: ATE

Gewindemaß 1: 3x M10x1

Gewindemaß 2: 1x M12x1

Ergänzungsartikel/Ergänzende Info 2: ohne Bremsflüssigkeitsbehälter

Länge 1 [mm]: 21,9

Länge 2 [mm]: 93

FORD, MAZDA

03.4153-0063.3**010773****Hauptbremszylinder**

Durchmesser [mm]: 23,8

Gewindemaß: M10x1

Anschlussanzahl: 2

MAPP-Code vorhanden:

Bremsystem: ATE

Länge 1 [mm]: 9,9

Länge 2 [mm]: 105,1

RENAULT**03.4153-0173.3****010815****Hauptbremszylinder**

Durchmesser [mm]: 23,8

Gewindemaß: M12x1

Anschlussanzahl: 2

MAPP-Code vorhanden:

Bremsystem: ATE

Länge 1 [mm]: 31,7

Länge 2 [mm]: 92,2

CITROËN, DS, PEUGEOT**03.4153-0186.3****010816****Hauptbremszylinder**

Durchmesser [mm]: 23,8

Gewindemaß: M12x1

Anschlussanzahl: 2

MAPP-Code vorhanden:

Bremsystem: ATE

Länge 1 [mm]: 27,1

Länge 2 [mm]: 117

AUDI, SEAT, VW**03.4153-5287.4****010953****Hauptbremszylinder**

Durchmesser [mm]: 23,8

Anschlussanzahl: 2

MAPP-Code vorhanden:

Bremsystem: ATE

Gewindemaß 1: 1x M10x1

Gewindemaß 2: 1x M12x1

Ergänzungsartikel/Ergänzende Info 2: mit Bremsflüssigkeitsbehälter

Länge 1 [mm]: 21,9

Länge 2 [mm]: 93

FORD, MAZDA

03.4153-5403.3**010994****Hauptbremszylinder**

Durchmesser [mm]: 23,8

Gewindemaß: M12x1

Anschlussanzahl: 2

MAPP-Code vorhanden:

Bremsystem: ATE

Länge 1 [mm]: 18

Länge 2 [mm]: 123,3

AUDI, SEAT, SKODA, VW**03.4155-0043.3****010795****Hauptbremszylinder**

Durchmesser [mm]: 25,4

Gewindemaß: M12x1

Anschlussanzahl: 2

MAPP-Code vorhanden:

Bremsystem: ATE

Länge 1 [mm]: 9,9

Länge 2 [mm]: 105

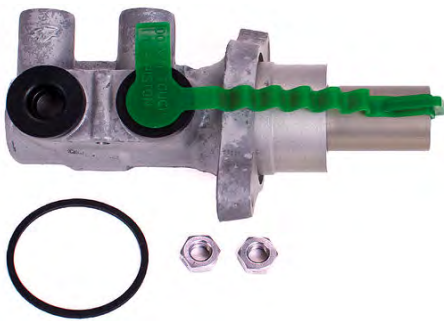
RENAULT**03.4155-0153.3****010927****Hauptbremszylinder**

Durchmesser [mm]: 25,4

Anschlussanzahl: 2

MAPP-Code vorhanden:

Bremsystem: ATE

Gewindemaß 1: 1x M10x1

Gewindemaß 2: 1x M12x1

Länge 1 [mm]: 24,2

Länge 2 [mm]: 90,7

OPEL, VAUXHALL**03.4155-0156.3****010862****Hauptbremszylinder**

Durchmesser [mm]: 25,4

Gewindemaß: M12x1

Anschlussanzahl: 2

MAPP-Code vorhanden:

Bremsystem: ATE

Länge 1 [mm]: 24,2

Länge 2 [mm]: 90,7

OPEL, VAUXHALL

03.4155-5141.3**010969****Hauptbremszylinder**

Durchmesser [mm]: 25,4

Gewindemaß: M12x1

Anschlussanzahl: 2

MAPP-Code vorhanden:

Bremsystem: ATE

Länge 1 [mm]: 15

Länge 2 [mm]: 110,9

MERCEDES-BENZ**03.4155-5451.3****010995****Hauptbremszylinder**

Durchmesser [mm]: 25,4

Gewindemaß: M14x1

Anschlussanzahl: 2

MAPP-Code vorhanden:

Bremsystem: ATE

Länge 1 [mm]: 21,9

Länge 2 [mm]: 93

FORD**03.4155-5456.3****010996****Hauptbremszylinder**

Durchmesser [mm]: 25,4

Gewindemaß: M14x1

Anschlussanzahl: 2

MAPP-Code vorhanden:

Bremsystem: ATE

Länge 1 [mm]: 21,9

Länge 2 [mm]: 93

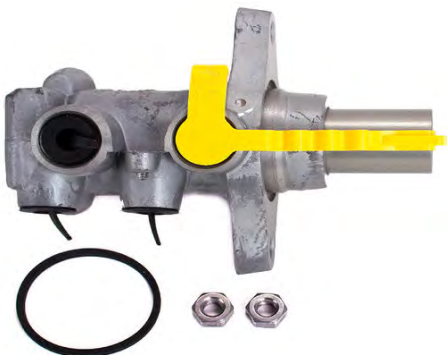
FORD**03.4156-0014.3****010930****Hauptbremszylinder**

Durchmesser [mm]: 27

Gewindemaß: M12x1

Anschlussanzahl: 2

MAPP-Code vorhanden:

Bremsystem: ATE

Ergänzungsartikel/Ergänzende Info 2: ohne Bremsflüssigkeitsbehälter

Länge 1 [mm]: 20

Länge 2 [mm]: 89,5

MERCEDES-BENZ

03.4156-0073.3

010942



Hauptbremszylinder

Durchmesser [mm]: 27

Gewindemaß: M12x1

Anschlussanzahl: 2

MAPP-Code vorhanden:

Bremssystem: ATE

Länge 1 [mm]: 13,2

Länge 2 [mm]: 102

MERCEDES-BENZ

03.4156-5106.3

010997



Hauptbremszylinder

Durchmesser [mm]: 27

Gewindemaß: M12x1

Anschlussanzahl: 2

MAPP-Code vorhanden:

Bremssystem: ATE

Länge 1 [mm]: 11,2

Länge 2 [mm]: 97,7

MERCEDES-BENZ

03.6043-1953.3

320201



Bremskraftregler

KenngroÙe: 3/45

Anschlussanzahl: 2

Bremssystem: ATE

FORD

03.6583-0054.3

320146



Bremskraftregler

KenngroÙe: 8/3

Anschlussanzahl: 4

lastabhangig:

Bremssystem: ATE

OPEL

03.6583-0073.3

320234



Bremskraftregler

KenngroÙe: 8/3

Anschlussanzahl: 4

lastabhangig:

Bremssystem: ATE

OPEL, VAUXHALL

03.6583-0085.3

320238



Bremskraftregler

KenngroÙe: 8/3

Anschlussanzahl: 4

lastabhangig:

Bremssystem: ATE

CHEVROLET, OPEL, VAUXHALL

03.6583-0216.3

320247



Bremskraftregler

KenngroÙe: 8/3

Anschlussanzahl: 4

lastabhangig:

Bremssystem: ATE

SEAT, SKODA, VW

03.6584-0107.3

320110



Bremskraftregler

KenngroÙe: 8/4

Anschlussanzahl: 4

lastabhangig:

Bremssystem: ATE

SKODA, VW

03.7745-1632.4

300293



Bremskraftverstarker

KenngroÙe: T52/4A Tandem

Durchmesser [Zoll]: 8 / 7

Betriebsart: pneumatisch

Bremssystem: ATE

MERCEDES-BENZ

03.7745-1832.4

300294



Bremskraftverstärker

KenngroÙe: T52/4A Tandem

Durchmesser [Zoll]: 8 / 7

Betriebsart: pneumatisch

Bremssystem: ATE

MERCEDES-BENZ

03.7745-3003.4

300157



Bremskraftverstärker

KenngroÙe: T52 Tandem

Durchmesser [Zoll]: 8 / 7

Betriebsart: pneumatisch

Bremssystem: ATE

OPEL, SAAB, VAUXHALL

03.7745-3902.4

300129



Bremskraftverstärker

KenngroÙe: T52 Tandem

Durchmesser [Zoll]: 8 / 7

Betriebsart: pneumatisch

Bremssystem: ATE

SAAB

03.7745-6302.4

300261



Bremskraftverstärker

KenngroÙe: T52

Durchmesser [Zoll]: 8

Betriebsart: pneumatisch

Bremssystem: ATE

MERCEDES-BENZ

03.7745-6502.4

300296

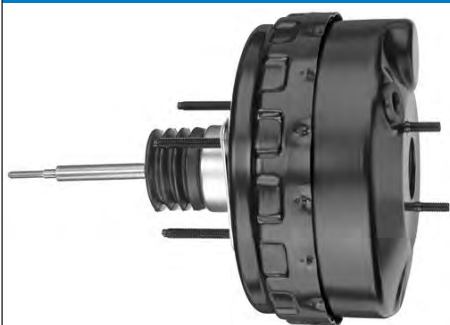

Bremskraftverstärker

KenngroÙe: T52/4

Durchmesser [Zoll]: 8

Betriebsart: pneumatisch

Bremssystem: ATE

JAGUAR

03.7745-8902.4

300297



Bremskraftverstärker

KenngroÙe: T52/4A

Durchmesser [Zoll]: 8

Betriebsart: pneumatisch

Bremssystem: ATE

MERCEDES-BENZ

03.7750-1332.4

300155



Bremskraftverstärker

KenngroÙe: T52

Durchmesser [Zoll]: 9

Betriebsart: pneumatisch

Bremssystem: ATE

RENAULT

03.7750-2932.4

300175



Bremskraftverstärker

KenngroÙe: T52

Durchmesser [Zoll]: 9

Betriebsart: pneumatisch

Bremssystem: ATE

SAAB

03.7750-5502.4

300081



Bremskraftverstärker

KenngroÙe: T52

Durchmesser [Zoll]: 9

Betriebsart: pneumatisch

Bremssystem: ATE

VW

03.7750-6002.4

300134



Bremskraftverstärker

KenngroÙe: T52

Durchmesser [Zoll]: 9

Betriebsart: pneumatisch

Bremssystem: ATE

VW

03.7750-6134.4

300319



Bremskraftverstärker

KenngroÙe: T52

Durchmesser [Zoll]: 9

Betriebsart: pneumatisch

Bremssystem: ATE

PEUGEOT

03.7750-6234.4

300320



Bremskraftverstärker

KenngroÙe: T52

Durchmesser [Zoll]: 9

Betriebsart: pneumatisch

Bremssystem: ATE

PEUGEOT

03.7750-6302.4

300161



Bremskraftverstärker

KenngroÙe: T52

Durchmesser [Zoll]: 9

Betriebsart: pneumatisch

Bremssystem: ATE

SEAT, VW

03.7750-6334.4

300321



Bremskraftverstärker

Kenngröße: T52/4

Durchmesser [Zoll]: 9

Betriebsart: pneumatisch

Bremssystem: ATE

PEUGEOT

03.7750-7132.4

300255



Bremskraftverstärker

Kenngröße: T52

Durchmesser [Zoll]: 9

Betriebsart: pneumatisch

Bremssystem: ATE

DAIHATSU, TOYOTA

03.7750-7332.4

300298



Bremskraftverstärker

Kenngröße: T52/4

Durchmesser [Zoll]: 9

Betriebsart: pneumatisch

Bremssystem: ATE

RENAULT

03.7750-7402.4

300084



Bremskraftverstärker

Kenngröße: T52

Durchmesser [Zoll]: 9

Betriebsart: pneumatisch

Bremssystem: ATE

VW

03.7750-8532.4

300264



Bremskraftverstärker

KenngroÙe: T52

Durchmesser [Zoll]: 9

Betriebsart: pneumatisch

Bremssystem: ATE

DACIA, RENAULT

03.7750-8732.4

300199



Bremskraftverstärker

KenngroÙe: T52

Durchmesser [Zoll]: 9

Betriebsart: pneumatisch

Bremssystem: ATE

FORD

03.7750-8832.4

300299



Bremskraftverstärker

KenngroÙe: T52/4

Durchmesser [Zoll]: 9

Betriebsart: pneumatisch

Bremssystem: ATE

RENAULT

03.7750-9302.4

300116



Bremskraftverstärker

KenngroÙe: T52/4

Durchmesser [Zoll]: 9

Betriebsart: pneumatisch

Bremssystem: ATE

CITROËN, PEUGEOT

03.7750-9402.4

300117



Bremskraftverstärker

KenngroÙe: T52/4

Durchmesser [Zoll]: 9

Betriebsart: pneumatisch

Bremssystem: ATE

PEUGEOT

03.7755-0132.4

300265



Bremskraftverstärker

KenngroÙe: T52/4 Tandem

Durchmesser [Zoll]: 9 / 8

Betriebsart: pneumatisch

Bremssystem: ATE

VOLVO



03.7755-1232.4

300260



Bremskraftverstärker

KenngroÙe: T52 Tandem

Durchmesser [Zoll]: 9 / 8

Betriebsart: pneumatisch

Bremssystem: ATE

LAND ROVER

03.7755-1432.4

300300



Bremskraftverstärker

KenngroÙe: T52/4 Tandem

Durchmesser [Zoll]: 9 / 8

Betriebsart: pneumatisch

Bremssystem: ATE

FORD

03.7755-1902.4

300138



Bremskraftverstärker

KenngroÙe: T52 Tandem

Durchmesser [Zoll]: 9 / 8

Betriebsart: pneumatisch

Bremssystem: ATE

FORD, SEAT, VW

03.7755-3402.4

300189



Bremskraftverstärker

Durchmesser [Zoll]: 9 / 8

MAPP-Code vorhanden:

Bremssystem: ATE

Abmessungen beachten:

KenngroÙe: T52 Tandem

Betriebsart: pneumatisch

Artikelnummer des empfohlenen Zubehörs: 03.0655-0004.2

VOLVO

03.7755-3532.4

300290



Bremskraftverstärker

KenngroÙe: T52 Tandem

Durchmesser [Zoll]: 9 / 8

Betriebsart: pneumatisch

Bremssystem: ATE

FORD

03.7755-4202.4

300164



Bremskraftverstärker

KenngroÙe: T52 Tandem

Durchmesser [Zoll]: 9 / 8

Betriebsart: pneumatisch

Bremssystem: ATE

VW

03.7755-4702.4

300224



Bremskraftverstärker

Durchmesser [Zoll]: 9 / 8

MAPP-Code vorhanden:

Bremssystem: ATE

Abmessungen beachten:

KenngroÙe: T52 Tandem

Betriebsart: pneumatisch

Artikelnummer des empfohlenen Zubehörs: 03.0655-0005.2

VOLVO

03.7755-6302.4

300221



Bremskraftverstärker

KenngroÙe: T52 Tandem

Durchmesser [Zoll]: 9 / 8

Betriebsart: pneumatisch

Bremssystem: ATE

FORD, SEAT, VW

03.7755-8202.4

300301



Bremskraftverstärker

Kenngröße: T52/4A Tandem

Durchmesser [Zoll]: 9 / 8

Betriebsart: pneumatisch

Bremssystem: ATE

MERCEDES-BENZ

03.7755-9703.4

300239



Bremskraftverstärker

Kenngröße: T52 Tandem

Durchmesser [Zoll]: 9 / 8

Betriebsart: pneumatisch

Bremssystem: ATE

VOLVO

03.7760-2232.4

300266



Bremskraftverstärker

Kenngröße: T52

Durchmesser [Zoll]: 10

Betriebsart: pneumatisch

Bremssystem: ATE

FORD

03.7760-2332.4

300267



Bremskraftverstärker

KenngroÙe: T52

Durchmesser [Zoll]: 10

Betriebsart: pneumatisch

Bremssystem: ATE

FORD

03.7760-2702.4

300090



Bremskraftverstärker

KenngroÙe: T52

Durchmesser [Zoll]: 10

Betriebsart: pneumatisch

Bremssystem: ATE

MERCEDES-BENZ

03.7760-3002.4

300120



Bremskraftverstärker

KenngroÙe: T52/4

Durchmesser [Zoll]: 10

Betriebsart: pneumatisch

Bremssystem: ATE

FORD, SEAT, VW



03.7760-3102.4

300139



Bremskraftverstärker

KenngroÙe: T52

Durchmesser [Zoll]: 10

Betriebsart: pneumatisch

Bremssystem: ATE

BMW

03.7760-5102.4

300140



Bremskraftverstärker

KenngroÙe: T52

Durchmesser [Zoll]: 10

Betriebsart: pneumatisch

Bremssystem: ATE

RENAULT

03.7760-5502.4

300151



Bremskraftverstärker

KenngroÙe: T52

Durchmesser [Zoll]: 10

Betriebsart: pneumatisch

Bremssystem: ATE

RENAULT

03.7760-5602.4

300121



Bremskraftverstärker

KenngroÙe: T52/4

Durchmesser [Zoll]: 10

Betriebsart: pneumatisch

Bremssystem: ATE

RENAULT

03.7760-8103.4

300240



Bremskraftverstärker

KenngroÙe: T52

Durchmesser [Zoll]: 10

Betriebsart: pneumatisch

Bremssystem: ATE

FORD

03.7765-1002.4

300246



Bremskraftverstärker

KenngroÙe: T52 Tandem

Durchmesser [Zoll]: 10 / 9

Betriebsart: pneumatisch

Bremssystem: ATE

VW



03.7845-0103.4

300268



Bremskraftverstärker

KenngroÙe: T52

Durchmesser [Zoll]: 8

Betriebsart: pneumatisch

Bremssystem: ATE

BMW

03.7845-2506.4

300329



Bremskraftverstärker

KenngroÙe: T52/4ZA Tandem

Durchmesser [Zoll]: 8

Betriebsart: pneumatisch

Bremssystem: ATE

MERCEDES-BENZ

03.7848-2002.4

300166



Bremskraftverstärker

Durchmesser [Zoll]: 7 / 8

MAPP-Code vorhanden:

Bremssystem: ATE

Abmessungen beachten:

KenngroÙe: T52/4 Tandem

Betriebsart: pneumatisch

Artikelnummer des empfohlenen Zubehörs: 03.0655-0007.2

MERCEDES-BENZ

03.7848-4003.4

300235



Bremskraftverstärker

KenngroÙe: T52

Durchmesser [Zoll]: 8

Betriebsart: pneumatisch

Bremssystem: ATE

BMW

03.7848-5003.4

300236



Bremskraftverstärker

KenngroÙe: T52

Durchmesser [Zoll]: 8

Betriebsart: pneumatisch

Bremssystem: ATE

BMW

03.7848-9802.4

300344



Bremskraftverstärker

KenngroÙe: T52/6Z Tandem

Durchmesser [Zoll]: 7 / 8

Betriebsart: pneumatisch

Bremssystem: ATE

SEAT, SKODA, VW

03.7850-0102.4

300180



Bremskraftverstärker

KenngroÙe: T52

Durchmesser [Zoll]: 9

Betriebsart: pneumatisch

Bremssystem: ATE

AUDI

03.7853-0202.4

300181



Bremskraftverstärker

KenngroÙe: T52

Durchmesser [Zoll]: 9

Betriebsart: pneumatisch

Bremssystem: ATE

AUDI

03.7853-0702.4

300195



Bremskraftverstärker

KenngroÙe: T52

Durchmesser [Zoll]: 9

Betriebsart: pneumatisch

Bremssystem: ATE

RENAULT

03.7853-0902.4

300150



Bremskraftverstärker

KenngroÙe: T52

Durchmesser [Zoll]: 9

Betriebsart: pneumatisch

Bremssystem: ATE

CITROËN

03.7853-2102.4

300201



Bremskraftverstärker

KenngroÙe: T52

Durchmesser [Zoll]: 9

Betriebsart: pneumatisch

Bremssystem: ATE

FORD

03.7853-2604.4

300322



Bremskraftverstärker

KenngroÙe: T52

Durchmesser [Zoll]: 9

Betriebsart: pneumatisch

Bremssystem: ATE

PEUGEOT

03.7853-2704.4

300323



Bremskraftverstärker

KenngroÙe: T52

Durchmesser [Zoll]: 9

Betriebsart: pneumatisch

Bremssystem: ATE

PEUGEOT

03.7853-3902.4

300270



Bremskraftverstärker

KenngroÙe: T52

Durchmesser [Zoll]: 9

Betriebsart: pneumatisch

Bremssystem: ATE

RENAULT

03.7853-4602.4

300302



Bremskraftverstärker

KenngroÙe: T52/5K

Durchmesser [Zoll]: 9

Betriebsart: pneumatisch

Bremssystem: ATE

DACIA, RENAULT



03.7858-0732.4

300272



Bremskraftverstärker

KenngroÙe: T52 Tandem

Durchmesser [Zoll]: 9 / 8

Betriebsart: pneumatisch

Bremssystem: ATE

CHEVROLET, OPEL, SAAB, VAUXHALL

03.7858-1932.4

300263



Bremskraftverstärker

Durchmesser [Zoll]: 9 / 8

MAPP-Code vorhanden:

Bremssystem: ATE

Abmessungen beachten:

KenngroÙe: T55 Tandem

Betriebsart: pneumatisch

Artikelnummer des empfohlenen Zubehörs: 03.0655-0007.2

MERCEDES-BENZ

03.7858-2802.4

300303



Bremskraftverstärker

KenngroÙe: T52/5 Tandem

Durchmesser [Zoll]: 9 / 8

Betriebsart: pneumatisch

Bremssystem: ATE

RENAULT

03.7858-3032.4

300257

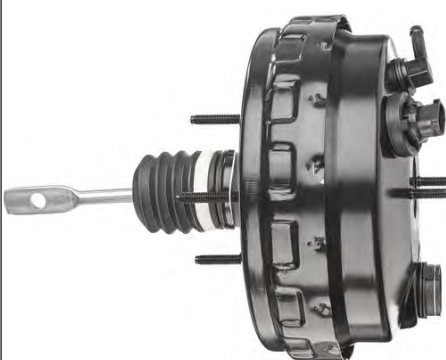

Bremskraftverstärker

Durchmesser [Zoll]: 9 / 8

MAPP-Code vorhanden:

Bremssystem: ATE

Abmessungen beachten:

KenngroÙe: T55/1 Tandem

Betriebsart: pneumatisch

Artikelnummer des empfohlenen Zubehörs: 03.0655-0005.2

VOLVO

03.7858-3302.4

300122



Bremskraftverstärker

KenngroÙe: T55/1 Tandem

Durchmesser [Zoll]: 9 / 8

Betriebsart: pneumatisch

Bremssystem: ATE

FORD, SEAT, VW

03.7858-3532.4

300233



Bremskraftverstärker

Durchmesser [Zoll]: 9 / 8

MAPP-Code vorhanden:

Bremssystem: ATE

Abmessungen beachten:

KenngroÙe: T52 Tandem

Betriebsart: pneumatisch

Artikelnummer des empfohlenen Zubehörs: 03.0655-0005.2

VOLVO

03.7858-3632.4

300234



Bremskraftverstärker

Durchmesser [Zoll]: 9 / 8

MAPP-Code vorhanden:

Bremssystem: ATE

Abmessungen beachten:

KenngroÙe: T52 Tandem

Betriebsart: pneumatisch

Artikelnummer des empfohlenen Zubehörs: 03.0655-0005.2

VOLVO

03.7858-4432.4

300304



Bremskraftverstärker

KenngroÙe: T52/4Z Tandem

Durchmesser [Zoll]: 9 / 8

Betriebsart: pneumatisch

Bremssystem: ATE

AUDI



03.7858-4502.4

300202



Bremskraftverstärker

KenngroÙe: T52 Tandem

Durchmesser [Zoll]: 9 / 8

Betriebsart: pneumatisch

Bremssystem: ATE

AUDI, SEAT

03.7858-4632.4

300273



Bremskraftverstärker

KenngroÙe: T52 Tandem

Durchmesser [Zoll]: 9 / 8

Betriebsart: pneumatisch

Bremssystem: ATE

AUDI

03.7858-5132.4

300276

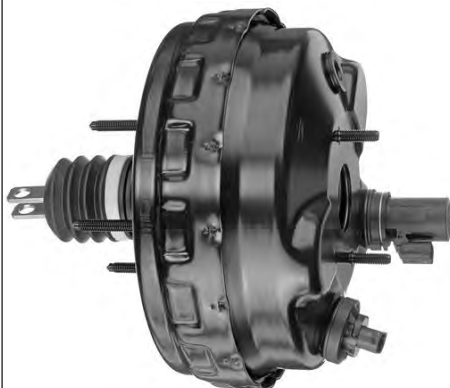

Bremskraftverstärker

KenngroÙe: T55 Tandem

Durchmesser [Zoll]: 9 / 8

Betriebsart: pneumatisch

Bremssystem: ATE

VOLVO

03.7858-9502.4

300205



Bremskraftverstärker

Durchmesser [Zoll]: 9 / 8

MAPP-Code vorhanden:

Bremssystem: ATE

Abmessungen beachten:

KenngroÙe: T55 Tandem

Betriebsart: pneumatisch

Artikelnummer des empfohlenen Zubehörs: 03.0655-0006.2

SEAT, VW

03.7860-0602.4

300141



Bremskraftverstärker

KenngroÙe: T52

Durchmesser [Zoll]: 10

Betriebsart: pneumatisch

Bremssystem: ATE

AUDI, SEAT, VW

03.7860-0702.4

300123



Bremskraftverstärker

KenngroÙe: T52/4

Durchmesser [Zoll]: 10

Betriebsart: pneumatisch

Bremssystem: ATE

BMW

03.7860-1402.4

300228



Bremskraftverstärker

KenngroÙe: T52/4

Durchmesser [Zoll]: 10

Betriebsart: pneumatisch

Bremssystem: ATE

MINI

03.7860-2002.4

300216



Bremskraftverstärker

KenngroÙe: T52

Durchmesser [Zoll]: 10

Betriebsart: pneumatisch

Bremssystem: ATE

CITROËN, PEUGEOT

03.7860-3402.4

300217



Bremskraftverstärker

KenngroÙe: T52

Durchmesser [Zoll]: 10

Betriebsart: pneumatisch

Bremssystem: ATE

CITROËN, PEUGEOT

03.7860-3702.4

300305



Bremskraftverstärker

KenngroÙe: T52/4Z

Durchmesser [Zoll]: 9

Betriebsart: pneumatisch

Bremssystem: ATE

RENAULT

03.7860-3734.4

300317



Bremskraftverstärker

KenngroÙe: T52

Durchmesser [Zoll]: 10

Betriebsart: pneumatisch

Bremssystem: ATE

CITROËN, DS, PEUGEOT

03.7860-4034.4

300318



Bremskraftverstärker

KenngroÙe: T52

Durchmesser [Zoll]: 10

Betriebsart: pneumatisch

Bremssystem: ATE

CITROËN

03.7860-4203.4

300243



Bremskraftverstärker

KenngroÙe: T52

Durchmesser [Zoll]: 10

Betriebsart: pneumatisch

Bremssystem: ATE

AUDI

03.7860-4432.4

300313

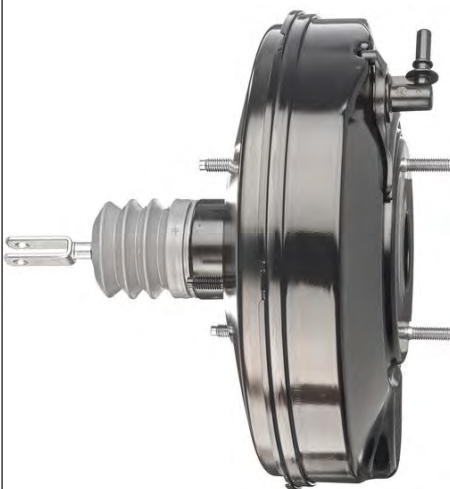

Bremskraftverstärker

KenngroÙe: T52/4

Durchmesser [Zoll]: 10

Betriebsart: pneumatisch

Bremssystem: ATE

CITROËN, PEUGEOT

03.7860-7802.4

300280



Bremskraftverstärker

KenngroÙe: T52

Durchmesser [Zoll]: 10

Betriebsart: pneumatisch

Bremssystem: ATE

CITROËN, PEUGEOT

03.7860-8002.4

300258



Bremskraftverstärker

KenngroÙe: T52

Durchmesser [Zoll]: 10

Betriebsart: pneumatisch

Bremssystem: ATE

CITROËN, PEUGEOT

03.7860-8802.4

300291



Bremskraftverstärker

KenngroÙe: T52

Durchmesser [Zoll]: 10

Betriebsart: pneumatisch

Bremssystem: ATE

VW

03.7863-0332.4

300203



Bremskraftverstärker

KenngroÙe: T52

Durchmesser [Zoll]: 10

Betriebsart: pneumatisch

Bremssystem: ATE

FORD

03.7863-0402.4

300124



Bremskraftverstärker

KenngroÙe: T55/1

Durchmesser [Zoll]: 10

Betriebsart: pneumatisch

Bremssystem: ATE

AUDI, SEAT, SKODA, VW

03.7863-1232.4

300314



Bremskraftverstärker

KenngroÙe: T52/5

Durchmesser [Zoll]: 10

Betriebsart: pneumatisch

Bremssystem: ATE

RENAULT

03.7863-2002.4

300126



Bremskraftverstärker

KenngroÙe: T52/5

Durchmesser [Zoll]: 10

Betriebsart: pneumatisch

Bremssystem: ATE

RENAULT

03.7863-2804.4

300324



Bremskraftverstärker

KenngroÙe: T52

Durchmesser [Zoll]: 10

Betriebsart: pneumatisch

Bremssystem: ATE

PEUGEOT



03.7863-3002.4

300223



Bremskraftverstärker

Kenngröße: T52/5

Durchmesser [Zoll]: 10

Betriebsart: pneumatisch

Bremssystem: ATE

NISSAN

03.7863-3232.4

300307



Bremskraftverstärker

Kenngröße: T52/6Z

Durchmesser [Zoll]: 10

Betriebsart: pneumatisch

Bremssystem: ATE

AUDI, SEAT, SKODA, VW

03.7863-3332.4

300308



Bremskraftverstärker

Kenngröße: T52/6Z

Durchmesser [Zoll]: 10

Betriebsart: pneumatisch

Bremssystem: ATE

AUDI, SEAT, SKODA, VW

03.7863-3502.4

300128

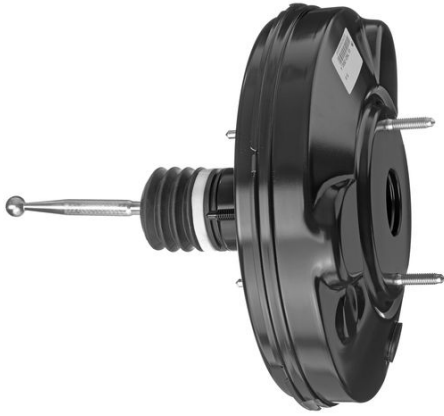

Bremskraftverstärker

KenngroÙe: T52/5

Durchmesser [Zoll]: 10

Betriebsart: pneumatisch

Bremssystem: ATE

AUDI, SKODA, VW

03.7863-3932.4

300288



Bremskraftverstärker

KenngroÙe: T52

Durchmesser [Zoll]: 10

Betriebsart: pneumatisch

Bremssystem: ATE

FORD

03.7863-4502.4

300230



Bremskraftverstärker

KenngroÙe: T52/5

Durchmesser [Zoll]: 10

Betriebsart: pneumatisch

Bremssystem: ATE

RENAULT

03.7863-4832.4

300289



Bremskraftverstärker

KenngroÙe: T52/5

Durchmesser [Zoll]: 10

Betriebsart: pneumatisch

Bremssystem: ATE

VOLVO

03.7863-7803.4

300237



Bremskraftverstärker

KenngroÙe: T52

Durchmesser [Zoll]: 10

Betriebsart: pneumatisch

Bremssystem: ATE

OPEL, VAUXHALL

03.7868-1602.4

300220



Bremskraftverstärker

KenngroÙe: T52 Tandem

Durchmesser [Zoll]: 10 / 8

Betriebsart: pneumatisch

Bremssystem: ATE

RENAULT

03.7868-3702.4

300208



Bremskraftverstärker

KenngroÙe: T55 Tandem

Durchmesser [Zoll]: 10 / 8

Betriebsart: pneumatisch

Bremssystem: ATE

VW

03.7868-4102.4

300250



Bremskraftverstärker

KenngroÙe: T52 Tandem

Durchmesser [Zoll]: 10 / 8

Betriebsart: pneumatisch

Bremssystem: ATE

PORSCHE

03.7868-5202.4

300309



Bremskraftverstärker

KenngroÙe: T52/5Z Tandem

Durchmesser [Zoll]: 10 / 8

Betriebsart: pneumatisch

Bremssystem: ATE

RENAULT

03.7868-5802.4

300315



Bremskraftverstärker

KenngroÙe: T52 Tandem

Durchmesser [Zoll]: 10 / 8

Betriebsart: pneumatisch

Bremssystem: ATE

AUDI

03.7868-5902.4

300316



Bremskraftverstärker

KenngroÙe: T52 Tandem

Durchmesser [Zoll]: 10 / 8

Betriebsart: pneumatisch

Bremssystem: ATE

AUDI



03.7870-0602.4

300310



Bremskraftverstärker

KenngroÙe: T52/4Z

Durchmesser [Zoll]: 11

Betriebsart: pneumatisch

Bremssystem: ATE

AUDI

03.7870-1002.4

300282



Bremskraftverstärker

KenngroÙe: T52

Durchmesser [Zoll]: 11

Betriebsart: pneumatisch

Bremssystem: ATE

CITROËN

03.7870-3002.4

300342



Bremskraftverstärker

KenngroÙe: T52/4Z

Durchmesser [Zoll]: 11

Betriebsart: pneumatisch

Bremssystem: ATE

AUDI

03.7873-1202.4

300197



Bremskraftverstärker

Durchmesser [Zoll]: 11

Betriebsart: pneumatisch

Bremssystem: ATE

RENAULT

03.7873-4302.4

300312

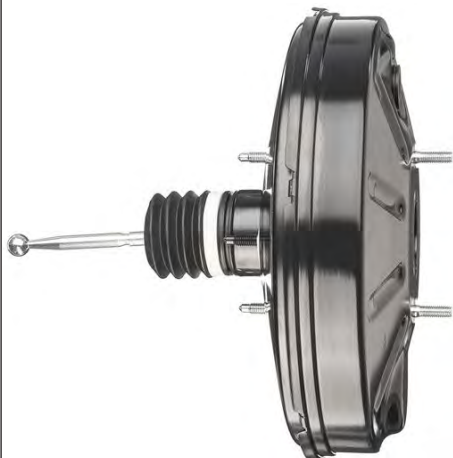

Bremskraftverstärker

KenngroÙe: T52/6Z

Durchmesser [Zoll]: 11

Betriebsart: pneumatisch

Bremssystem: ATE

VW

03.7873-4402.4

300292



Bremskraftverstärker

KenngroÙe: T52

Durchmesser [Zoll]: 11

Betriebsart: pneumatisch

Bremssystem: ATE

VW



03.7873-4502.4

300284



Bremskraftverstärker

KenngroÙe: T52

Durchmesser [Zoll]: 11

Betriebsart: pneumatisch

Bremssystem: ATE

SEAT, VW

10.6123-0239.3

010335



Hauptbremszylinder

Durchmesser [mm]: 23,8

GewindemaÙ: M10x1

Anschlusszahl: 2

MAPP-Code vorhanden:

Bremssystem: ATE

Länge 1 [mm]: 43,3

Länge 2 [mm]: 132

BMW

10.6123-0312.3

010457



Hauptbremszylinder

Durchmesser [mm]: 23,8

Anschlusszahl: 2

MAPP-Code vorhanden:

Bremssystem: ATE

GewindemaÙ 1: 1x M10x1

GewindemaÙ 2: 1x M12x1

Länge 1 [mm]: 38

Länge 2 [mm]: 133,2

RENAULT

10.6123-0674.3

010639



Hauptbremszylinder

Durchmesser [mm]: 23,8

GewindemaÙ: M10x1

Anschlusszahl: 2

MAPP-Code vorhanden:

Bremssystem: ATE

Länge 1 [mm]: 41

Länge 2 [mm]: 127,9

VW

10.6350-3902.4

300213



Bremskraftverstärker

KenngroÙe: T52

Durchmesser [Zoll]: 9

Betriebsart: pneumatisch

Bremssystem: ATE

SEAT, VW

10.6350-4002.4

300285



Bremskraftverstärker

KenngroÙe: T52

Durchmesser [Zoll]: 9

Betriebsart: pneumatisch

Bremssystem: ATE

SEAT, VW

10.6360-1903.4

300093



Bremskraftverstärker

Durchmesser [Zoll]: 10

MAPP-Code vorhanden:

Bremssystem: ATE

Abmessungen beachten:

KenngroÙe: T52

Betriebsart: pneumatisch

Artikelnummer des empfohlenen Zubehörs: 03.0655-0002.2

BMW

10.6360-2002.4

300143



Bremskraftverstärker

KenngroÙe: T52

Durchmesser [Zoll]: 10

Betriebsart: pneumatisch

Bremssystem: ATE

VW



24.2022-1601.3**010340****Hauptbremszylinder**

Durchmesser 1 [mm]: 22,2

Durchmesser 2 [mm]: 17,5

Gewindemaß: M10x1

Anschlussanzahl: 3

MAPP-Code vorhanden:

Länge 1 [mm]: 58

Länge 2 [mm]: 113

MERCEDES-BENZ**24.2023-1601.3****010341****Hauptbremszylinder**

Durchmesser [mm]: 23,8

Gewindemaß: M10x1

Anschlussanzahl: 3

MAPP-Code vorhanden:

Bremsystem: TRW

Länge 1 [mm]: 50

Länge 2 [mm]: 120,5

BMW**24.2023-1701.3****010514****Hauptbremszylinder**

Durchmesser 1 [mm]: 23,8

Durchmesser 2 [mm]: 19

Anschlussanzahl: 2

MAPP-Code vorhanden:

Bremsystem: TRW

Gewindemaß 1: 1x M10x1

Gewindemaß 2: 1x M12x1

Länge 1 [mm]: 51,5

Länge 2 [mm]: 106

MERCEDES-BENZ**24.2023-1702.3****010534****Hauptbremszylinder**

Durchmesser 1 [mm]: 23,8

Durchmesser 2 [mm]: 19

Gewindemaß: M12x1

Anschlussanzahl: 3

MAPP-Code vorhanden:

Bremsystem: TRW

Länge 1 [mm]: 24

Länge 2 [mm]: 125

MERCEDES-BENZ

24.2023-1704.3**010635****Hauptbremszylinder**

Durchmesser [mm]: 23,8

Gewindemaß: M12x1

Anschlussanzahl: 3

MAPP-Code vorhanden:

Bremsystem: TRW

Länge 1 [mm]: 14

Länge 2 [mm]: 135

MERCEDES-BENZ**24.2025-1702.3****010515****Hauptbremszylinder**

Durchmesser 1 [mm]: 25,4

Durchmesser 2 [mm]: 19

Anschlussanzahl: 2

MAPP-Code vorhanden:

Gewindemaß 1: 1x M10x1

Gewindemaß 2: 1x M12x1

Länge 1 [mm]: 51,3

Länge 2 [mm]: 106,2

MERCEDES-BENZ**24.2025-1703.3****010516****Hauptbremszylinder**

Durchmesser 1 [mm]: 25,4

Durchmesser 2 [mm]: 19

Gewindemaß: M12x1

Anschlussanzahl: 2

MAPP-Code vorhanden:

Länge 1 [mm]: 51,3

Länge 2 [mm]: 106,2

MERCEDES-BENZ**24.2025-1704.3****010619****Hauptbremszylinder**

Durchmesser [mm]: 25,4

Anschlussanzahl: 3

MAPP-Code vorhanden:

Gewindemaß 1: 1x M10x1

Gewindemaß 2: 2x M12x1

Länge 1 [mm]: 51,3

Länge 2 [mm]: 107,7

BMW

24.2025-1705.3**010624****Hauptbremszylinder**

Durchmesser 1 [mm]: 25,4

Durchmesser 2 [mm]: 20,6

Anschlussanzahl: 2

MAPP-Code vorhanden:

Bremsssystem: TRW

Gewindemaß 1: 1x M10x1

Gewindemaß 2: 1x M12x1

Länge 1 [mm]: 51,5

Länge 2 [mm]: 108

BMW**24.2025-1706.3****010676****Hauptbremszylinder**

Durchmesser [mm]: 25,4

Anschlussanzahl: 2

MAPP-Code vorhanden:

Gewindemaß 1: 1x M10x1

Gewindemaß 2: 1x M12x1

Länge 1 [mm]: 33

Länge 2 [mm]: 127

NISSAN, OPEL, RENAULT, VAUXHALL**24.2025-1707.3****010691****Hauptbremszylinder**

Durchmesser [mm]: 25,4

Gewindemaß: M12x1

Anschlussanzahl: 2

MAPP-Code vorhanden:

Länge 1 [mm]: 51,7

Länge 2 [mm]: 108,5

BMW**24.2025-1708.3****010692****Hauptbremszylinder**

Durchmesser [mm]: 25,4

Anschlussanzahl: 5

MAPP-Code vorhanden:

Gewindemaß 1: 3x M10x1

Gewindemaß 2: 2x M12x1

Länge 1 [mm]: 33

Länge 2 [mm]: 127

NISSAN, OPEL, RENAULT, VAUXHALL

24.2025-1709.3**010693****Hauptbremszylinder**

Durchmesser [mm]: 25,4

Gewindemaß: M12x1

Anschlussanzahl: 2

MAPP-Code vorhanden:

Länge 1 [mm]: 51,3

Länge 2 [mm]: 108

MERCEDES-BENZ**24.2025-1710.3****010833****Hauptbremszylinder**

Durchmesser [mm]: 25,4

Gewindemaß: M12x1

Anschlussanzahl: 2

MAPP-Code vorhanden:

Bremsystem: TRW

Länge 1 [mm]: 69,3

Länge 2 [mm]: 90

BMW**24.2025-2311.3****011023****Hauptbremszylinder**

Durchmesser 1 [mm]: 25,4

Durchmesser 2 [mm]: 20,6

Gewindemaß: M12x1

Anschlussanzahl: 2

MAPP-Code vorhanden:

Bremsystem: ATE

Länge 1 [mm]: 114,3

Länge 2 [mm]: 57,6

MERCEDES-BENZ**24.2026-1701.3****010746****Hauptbremszylinder**

Durchmesser 2 [mm]: 20,6

Durchmesser [mm]: 27

Gewindemaß: M12x1

Anschlussanzahl: 3

MAPP-Code vorhanden:

Länge 1 [mm]: 51,2

Länge 2 [mm]: 107,3

BMW

24.2026-1702.3

010850



Hauptbremszylinder

Durchmesser 2 [mm]: 22,2

Durchmesser [mm]: 27

Gewindemaß: M12x1

Anschlussanzahl: 2

MAPP-Code vorhanden:

Bremssystem: TRW

Länge 1 [mm]: 69,2

Länge 2 [mm]: 90,5

BMW

24.2026-1704.3

010989



Hauptbremszylinder

Durchmesser 2 [mm]: 20,6

Durchmesser [mm]: 27

Gewindemaß: M14x1

Anschlussanzahl: 2

MAPP-Code vorhanden:

Bremssystem: TRW

Länge 1 [mm]: 51,5

Länge 2 [mm]: 109

LAND ROVER

24.2026-1705.3

010992



Hauptbremszylinder

Durchmesser 2 [mm]: 20,6

Durchmesser [mm]: 27

Gewindemaß: M12x1

Anschlussanzahl: 3

MAPP-Code vorhanden:

Bremssystem: TRW

Länge 1 [mm]: 51

Länge 2 [mm]: 110

BMW, LAND ROVER

24.2026-1706.3

011040



Hauptbremszylinder

Durchmesser 2 [mm]: 22,2

Durchmesser [mm]: 27

Gewindemaß: M12x1

Anschlussanzahl: 2

MAPP-Code vorhanden:

Bremssystem: TRW

Länge 1 [mm]: 69,5

Länge 2 [mm]: 92

BMW

24.2119-0826.3**010349****Hauptbremszylinder**

Durchmesser [mm]: 19

Gewindemaß: M10x1

Anschlussanzahl: 3

MAPP-Code vorhanden:

Länge 1 [mm]: 12

Länge 2 [mm]: 178,4

FIAT**24.2119-0831.3****010416****Hauptbremszylinder**

Durchmesser [mm]: 19

Gewindemaß: M10x1,25

Anschlussanzahl: 3

MAPP-Code vorhanden:

Länge 1 [mm]: 9,5

Länge 2 [mm]: 190

LADA**24.2119-0832.3****010417****Hauptbremszylinder**

Durchmesser [mm]: 19

Gewindemaß: M10x1,25

Anschlussanzahl: 3

MAPP-Code vorhanden:

Länge 1 [mm]: 9,5

Länge 2 [mm]: 190

LADA**24.2119-0833.3****010418****Hauptbremszylinder**

Durchmesser [mm]: 19

Gewindemaß: M10x1

Anschlussanzahl: 4

MAPP-Code vorhanden:

Länge 1 [mm]: 10,5

Länge 2 [mm]: 190

FIAT

24.2119-1702.3**010435****Hauptbremszylinder**

Durchmesser [mm]: 19

Gewindemaß: M10x1

Anschlussanzahl: 4

MAPP-Code vorhanden:

Bremsystem: BDX

Länge 1 [mm]: 40

Länge 2 [mm]: 115,2

PEUGEOT**24.2119-1708.3****010543****Hauptbremszylinder**

Durchmesser [mm]: 19

Gewindemaß: M10x1

Anschlussanzahl: 4

MAPP-Code vorhanden:

Bremsystem: BDX

Länge 1 [mm]: 34,5

Länge 2 [mm]: 116,5

CITROËN, PEUGEOT**24.2119-1711.3****010911****Hauptbremszylinder**

Durchmesser [mm]: 19

Gewindemaß: M12x1

Anschlussanzahl: 2

MAPP-Code vorhanden:

Ergänzungsartikel/Ergänzende Info 2: ohne Bremsflüssigkeitsbehälter

Länge 1 [mm]: 41

Länge 2 [mm]: 116,5

SMART**24.2119-1715.3****011095****Hauptbremszylinder**

Gewindemaß 1: M10x1

Durchmesser [mm]: 19

Anschlussanzahl: 4

Ergänzungsartikel/Ergänzende Info 2: ohne Bremsflüssigkeitsbehälter

Länge 1 [mm]: 36,5

Länge 2 [mm]: 105

NISSAN

24.2119-1716.3**011120****Hauptbremszylinder**

Gewindemaß 1: M12x1

Durchmesser [mm]: 19

Anschlussanzahl: 4

Ergänzungsartikel/Ergänzende Info 2: ohne Bremsflüssigkeitsbehälter

Bremsystem: FTE

Länge 1 [mm]: 30

Länge 2 [mm]: 140

SKODA, VW**24.2120-0702.3****010361****Hauptbremszylinder**

Durchmesser [mm]: 20,6

Anschlussanzahl: 4

MAPP-Code vorhanden:

Bremsystem: nicht für Delco

Gewindemaß 1: 2x M10x1

Gewindemaß 2: 2x M12x1

Länge 1 [mm]: 16

Länge 2 [mm]: 130

CHEVROLET, OPEL, VAUXHALL**24.2120-0802.3****010363****Hauptbremszylinder**

Durchmesser [mm]: 20,6

Gewindemaß: M10x1

Anschlussanzahl: 3

MAPP-Code vorhanden:

Bremsystem: ATE

Länge 1 [mm]: 39,1

Länge 2 [mm]: 120,4

FIAT**24.2120-0803.3****010415****Hauptbremszylinder**

Durchmesser [mm]: 20,6

Gewindemaß: M10x1,25

Anschlussanzahl: 4

MAPP-Code vorhanden:

Länge 1 [mm]: 9

Länge 2 [mm]: 178,5

LADA

24.2120-1704.3**010429****Hauptbremszylinder**

Durchmesser [mm]: 20,6

Gewindemaß: M10x1

Anschlussanzahl: 4

MAPP-Code vorhanden:

Bremsystem: BDX

Länge 1 [mm]: 40

Länge 2 [mm]: 114,2

PEUGEOT**24.2120-1706.3****010262****Hauptbremszylinder**

Durchmesser [mm]: 20,6

Gewindemaß: M10x1

Anschlussanzahl: 4

MAPP-Code vorhanden:

Länge 1 [mm]: 40,1

Länge 2 [mm]: 118

RENAULT**24.2120-1710.3****010468****Hauptbremszylinder**

Durchmesser [mm]: 20,6

Gewindemaß: M10x1

Anschlussanzahl: 4

MAPP-Code vorhanden:

Länge 1 [mm]: 33,5

Länge 2 [mm]: 130

FIAT, LANCIA**24.2120-1714.3****010455****Hauptbremszylinder**

Gewindemaß 1: 1x M10x1

Durchmesser [mm]: 20,6

Gewindemaß 2: 1x M12x1

Anschlussanzahl: 2

Länge 1 [mm]: 16

Länge 2 [mm]: 130,5

CHEVROLET, OPEL, VAUXHALL

24.2120-1721.3**010553****Hauptbremszylinder**

Durchmesser [mm]: 20,6

Anschlussanzahl: 3

MAPP-Code vorhanden:

Gewindemaß 1: 2x M10x1

Gewindemaß 2: 1x M12x1

Länge 1 [mm]: 51,3

Länge 2 [mm]: 143,8

BMW**24.2120-1722.3****010544****Hauptbremszylinder**

Durchmesser [mm]: 20,6

Gewindemaß: M10x1

Anschlussanzahl: 4

MAPP-Code vorhanden:

Länge 1 [mm]: 34,5

Länge 2 [mm]: 116,5

CITROËN, PEUGEOT**24.2120-1723.3****010545****Hauptbremszylinder**

Durchmesser [mm]: 20,6

Gewindemaß: M10x1

Anschlussanzahl: 2

MAPP-Code vorhanden:

Bremsystem: BDX

Länge 1 [mm]: 34,5

Länge 2 [mm]: 118

RENAULT**24.2120-1725.3****010579****Hauptbremszylinder**

Durchmesser [mm]: 20,6

Gewindemaß: M10x1

Anschlussanzahl: 2

MAPP-Code vorhanden:

Bremsystem: BDX

Länge 1 [mm]: 34,5

Länge 2 [mm]: 118

RENAULT

24.2120-1726.3**010564****Hauptbremszylinder**

Durchmesser [mm]: 20,6

Anschlussanzahl: 2

Bremsystem: BDX

Gewindemaß 1: 1x M10x1

Gewindemaß 2: 1x M12x1

Länge 1 [mm]: 33

Länge 2 [mm]: 120

PEUGEOT**24.2120-1730.3****010678****Hauptbremszylinder**

Durchmesser [mm]: 20,6

Gewindemaß: M10x1

Anschlussanzahl: 2

MAPP-Code vorhanden:

Länge 1 [mm]: 34,5

Länge 2 [mm]: 116,2

OPEL, SUBARU, SUZUKI, VAUXHALL**24.2120-1734.3****010702****Hauptbremszylinder**

Durchmesser [mm]: 20,6

Gewindemaß: M12x1

Anschlussanzahl: 2

MAPP-Code vorhanden:

Länge 1 [mm]: 38,5

Länge 2 [mm]: 139,5

SEAT, SKODA, VW**24.2120-1736.3****010732****Hauptbremszylinder**

Durchmesser [mm]: 20,6

Gewindemaß: M12x1

Anschlussanzahl: 4

MAPP-Code vorhanden:

Länge 1 [mm]: 28,1

Länge 2 [mm]: 138,2

SEAT, SKODA, VW

24.2120-1737.3**010757****Hauptbremszylinder**

Durchmesser [mm]: 20,6

Anschlussanzahl: 4

MAPP-Code vorhanden:

Gewindemaß 1: 2x M10x1

Gewindemaß 2: 2x M12x1

Länge 1 [mm]: 30

Länge 2 [mm]: 117

PEUGEOT**24.2120-1738.3****010759****Hauptbremszylinder**

Durchmesser [mm]: 20,6

Anschlussanzahl: 4

MAPP-Code vorhanden:

Bremsssystem: TRW

Gewindemaß 1: 2x M10x1

Gewindemaß 2: 2x M12x1

Länge 1 [mm]: 51

Länge 2 [mm]: 139

NISSAN, RENAULT**24.2120-1740.3****010764****Hauptbremszylinder**

Durchmesser [mm]: 20,6

Gewindemaß: M12x1

Anschlussanzahl: 4

MAPP-Code vorhanden:

Bremsssystem: TRW

Länge 1 [mm]: 51

Länge 2 [mm]: 139

NISSAN, RENAULT**24.2120-1741.3****010775****Hauptbremszylinder**

Durchmesser [mm]: 20,6

Gewindemaß: M12x1

Anschlussanzahl: 4

MAPP-Code vorhanden:

Länge 1 [mm]: 24

Länge 2 [mm]: 132

CITROËN

24.2120-1742.3**010776****Hauptbremszylinder**

Durchmesser [mm]: 20,6

Gewindemaß: M10x1

Anschlussanzahl: 4

MAPP-Code vorhanden:

Länge 1 [mm]: 33

Länge 2 [mm]: 125

FIAT**24.2120-1743.3****010777****Hauptbremszylinder**

Durchmesser [mm]: 20,6

Gewindemaß: M10x1

Anschlussanzahl: 2

MAPP-Code vorhanden:

Länge 1 [mm]: 33

Länge 2 [mm]: 125

FIAT**24.2120-1744.3****010820****Hauptbremszylinder**

Durchmesser [mm]: 20,6

Gewindemaß: M10x1

Anschlussanzahl: 4

MAPP-Code vorhanden:

Länge 1 [mm]: 36,5

Länge 2 [mm]: 132,5

FIAT**24.2120-1746.3****010835****Hauptbremszylinder**

Durchmesser [mm]: 20,6

Gewindemaß: M12x1

Anschlussanzahl: 2

MAPP-Code vorhanden:

Bremsystem: BOS

Länge 1 [mm]: 33

Länge 2 [mm]: 130,5

FIAT

24.2120-1747.3**010836****Hauptbremszylinder**

Durchmesser [mm]: 20,6

Gewindemaß: M10x1

Anschlussanzahl: 2

MAPP-Code vorhanden:

Bremsystem: BOS

Länge 1 [mm]: 36,5

Länge 2 [mm]: 134

FIAT**24.2120-1748.3****010894****Hauptbremszylinder**

Durchmesser [mm]: 20,6

Gewindemaß: M12x1

Anschlussanzahl: 2

MAPP-Code vorhanden:

Bremsystem: TRW

Länge 1 [mm]: 25

Länge 2 [mm]: 162

OPEL, RENAULT, VAUXHALL**24.2120-1749.3****010903****Hauptbremszylinder**

Durchmesser [mm]: 20,6

Länge über Alles [mm]: 245

Gewindemaß: M10x1

Anschlussanzahl: 2

MAPP-Code vorhanden:

Bremsystem: TRW

TOYOTA**24.2120-1751.3****010909****Hauptbremszylinder**

Durchmesser [mm]: 20,6

Gewindemaß: M10x1

Anschlussanzahl: 2

MAPP-Code vorhanden:

Länge 1 [mm]: 15,5

Länge 2 [mm]: 153,5

HONDA

24.2120-1752.3**010928****Hauptbremszylinder**

Durchmesser [mm]: 20,6

Gewindemaß: M10x1

Anschlussanzahl: 2

MAPP-Code vorhanden:

Bremsystem: ATE

Ergänzungsartikel/Ergänzende Info 2: mit Bremsflüssigkeitsbehälter

Länge 1 [mm]: 26

Länge 2 [mm]: 157

HONDA**24.2120-1753.3****010946****Hauptbremszylinder**

Durchmesser [mm]: 20,6

Anschlussanzahl: 4

MAPP-Code vorhanden:

Bremsystem: TRW

Gewindemaß 1: 2x M10x1

Gewindemaß 2: 2x M12x1

Länge 1 [mm]: 25

Länge 2 [mm]: 160

OPEL, RENAULT, VAUXHALL**24.2120-1754.3****010949****Hauptbremszylinder**

Durchmesser [mm]: 20,6

Anschlussanzahl: 2

MAPP-Code vorhanden:

Gewindemaß 1: M10x1

Gewindemaß 2: M12x1

Länge 1 [mm]: 23,5

Länge 2 [mm]: 107,5

DACIA, RENAULT**24.2120-1755.3****010974****Hauptbremszylinder**

Durchmesser [mm]: 20,6

Gewindemaß: M10x1

Anschlussanzahl: 2

MAPP-Code vorhanden:

Ergänzungsartikel/Ergänzende Info 2: ohne Bremsflüssigkeitsbehälter

Länge 1 [mm]: 16,5

Länge 2 [mm]: 129,5

CHEVROLET, DAEWOO

24.2120-1756.3**010975****Hauptbremszylinder**

Durchmesser [mm]: 20,6

Gewindemaß: M10x1

Anschlussanzahl: 2

MAPP-Code vorhanden:

Ergänzungsartikel/Ergänzende Info 2: ohne Bremsflüssigkeitsbehälter

Länge 1 [mm]: 29,5

Länge 2 [mm]: 152

MAZDA**24.2120-1757.3****010976****Hauptbremszylinder**

Durchmesser [mm]: 20,6

Gewindemaß: M10x1

Anschlussanzahl: 2

MAPP-Code vorhanden:

Ergänzungsartikel/Ergänzende Info 2: ohne Bremsflüssigkeitsbehälter

Länge 1 [mm]: 23

Länge 2 [mm]: 172

TOYOTA**24.2120-1759.3****011083****Hauptbremszylinder**

Durchmesser [mm]: 20,6

Gewindemaß: M12x1

Anschlussanzahl: 2

Material: Aluguss

MAPP-Code vorhanden:

Ergänzungsartikel/Ergänzende Info 2: ohne Bremsflüssigkeitsbehälter

Länge 1 [mm]: 19

Länge 2 [mm]: 173,3

HONDA**24.2120-1760.3****011018****Hauptbremszylinder**

Durchmesser [mm]: 20,6

Gewindemaß: M14x1,5

Anschlussanzahl: 2

MAPP-Code vorhanden:

Ergänzungsartikel/Ergänzende Info 2: ohne Bremsflüssigkeitsbehälter

Länge 1 [mm]: 13,5

Länge 2 [mm]: 169,5

TOYOTA

24.2120-1761.3**011090****Hauptbremszylinder**

Durchmesser [mm]: 20,6

Gewindemaß: M12x1

Anschlussanzahl: 2

MAPP-Code vorhanden:

Ergänzungsartikel/Ergänzende Info 2: ohne Bremsflüssigkeitsbehälter

Länge 1 [mm]: 28

Länge 2 [mm]: 105,4

MAZDA**24.2120-1762.3****011002****Hauptbremszylinder**

Durchmesser [mm]: 20,6

Anschlussanzahl: 4

MAPP-Code vorhanden:

Gewindemaß 1: 2x M10x1

Gewindemaß 2: 2x M12x1

Ergänzungsartikel/Ergänzende Info 2: ohne Bremsflüssigkeitsbehälter

Länge 1 [mm]: 23,5

Länge 2 [mm]: 107,5

DACIA, RENAULT**24.2120-1765.3****011003****Hauptbremszylinder**

Durchmesser [mm]: 20,6

Gewindemaß: M10x1

Anschlussanzahl: 2

MAPP-Code vorhanden:

Ergänzungsartikel/Ergänzende Info 2: ohne Bremsflüssigkeitsbehälter

Länge 1 [mm]: 16

Länge 2 [mm]: 129,5

CHEVROLET, DAEWOO**24.2120-1766.3****011000****Hauptbremszylinder**

Durchmesser [mm]: 20,6

Gewindemaß: M10x1

Anschlussanzahl: 2

MAPP-Code vorhanden:

Ergänzungsartikel/Ergänzende Info 2: ohne Bremsflüssigkeitsbehälter

Länge 1 [mm]: 33

Länge 2 [mm]: 116,5

TOYOTA

24.2120-1767.3**011004****Hauptbremszylinder**

Durchmesser [mm]: 20,6

Gewindemaß: M10x1

Anschlussanzahl: 2

MAPP-Code vorhanden:

Ergänzungsartikel/Ergänzende Info 2: ohne Bremsflüssigkeitsbehälter

Länge 1 [mm]: 38,5

Länge 2 [mm]: 113,5

HYUNDAI**24.2120-1768.3****011041****Hauptbremszylinder**

Durchmesser [mm]: 20,6

Gewindemaß: M12x1

Anschlussanzahl: 2

MAPP-Code vorhanden:

Ergänzungsartikel/Ergänzende Info 2: ohne Bremsflüssigkeitsbehälter

Länge 1 [mm]: 26

Länge 2 [mm]: 143

SKODA**24.2120-1770.3****011066****Hauptbremszylinder**

Durchmesser [mm]: 20,6

Gewindemaß: M10x1

Anschlussanzahl: 4

MAPP-Code vorhanden:

Bremsystem: ATE

Ergänzungsartikel/Ergänzende Info 2: ohne Bremsflüssigkeitsbehälter

Länge 1 [mm]: 32,5

Länge 2 [mm]: 117,5

FIAT**24.2122-1588.3****011028****Hauptbremszylinder**

Durchmesser [mm]: 22,2

Gewindemaß: M10x1

Anschlussanzahl: 4

MAPP-Code vorhanden:

Bremsystem: ATE

Ergänzungsartikel/Ergänzende Info 2: ohne Druckregler

Länge 1 [mm]: 27,4

Länge 2 [mm]: 124

FORD

24.2122-1703.3**010422****Hauptbremszylinder**

Durchmesser [mm]: 22,2

Gewindemaß: M10x1

Anschlussanzahl: 4

MAPP-Code vorhanden:

Länge 1 [mm]: 36,2

Länge 2 [mm]: 115,2

CITROËN, FIAT, PEUGEOT**24.2122-1707.3****010438****Hauptbremszylinder**

Durchmesser [mm]: 22,2

Gewindemaß: M10x1

Anschlussanzahl: 4

MAPP-Code vorhanden:

Länge 1 [mm]: 36,5

Länge 2 [mm]: 128

RENAULT**24.2122-1708.3****010437****Hauptbremszylinder**

Durchmesser [mm]: 22,2

Gewindemaß: M10x1

Anschlussanzahl: 2

MAPP-Code vorhanden:

Länge 1 [mm]: 35

Länge 2 [mm]: 131,5

CITROËN, FIAT, PEUGEOT**24.2122-1715.3****010481****Hauptbremszylinder**

Durchmesser [mm]: 22,2

Gewindemaß: M10x1

Anschlussanzahl: 5

MAPP-Code vorhanden:

Länge 1 [mm]: 19

Länge 2 [mm]: 167

CITROËN, FIAT, PEUGEOT

24.2122-1716.3**010485****Hauptbremszylinder**

Durchmesser [mm]: 22,2

Gewindemaß: M10x1

Anschlussanzahl: 4

MAPP-Code vorhanden:

Länge 1 [mm]: 36

Länge 2 [mm]: 132

ALFA ROMEO, FIAT**24.2122-1718.3****010517****Hauptbremszylinder**

Durchmesser [mm]: 22,2

Gewindemaß: M10x1

Anschlussanzahl: 2

MAPP-Code vorhanden:

Länge 1 [mm]: 36,5

Länge 2 [mm]: 117

MITSUBISHI, VOLVO**24.2122-1724.3****010561****Hauptbremszylinder**

Durchmesser [mm]: 22,2

Anschlussanzahl: 2

MAPP-Code vorhanden:

Gewindemaß 1: 1x M10x1

Gewindemaß 2: 1x M12x1

Länge 1 [mm]: 23,5

Länge 2 [mm]: 122,5

OPEL, VAUXHALL**24.2122-1727.3****010586****Hauptbremszylinder**

Durchmesser [mm]: 22,2

Anschlussanzahl: 4

MAPP-Code vorhanden:

Bremsssystem: BDX

Gewindemaß 1: 2x M10x1

Gewindemaß 2: 2x M12x1

Länge 1 [mm]: 34,5

Länge 2 [mm]: 115,5

NISSAN, RENAULT

24.2122-1731.3**010656****Hauptbremszylinder**

Durchmesser [mm]: 22,2

Gewindemaß: M10x1

Anschlussanzahl: 4

MAPP-Code vorhanden:

Länge 1 [mm]: 36

Länge 2 [mm]: 150,2

SKODA, VW**24.2122-1733.3****010668****Hauptbremszylinder**

Durchmesser [mm]: 22,2

Anschlussanzahl: 4

MAPP-Code vorhanden:

Gewindemaß 1: 2x M10x1

Gewindemaß 2: 2x M12x1

Länge 1 [mm]: 34,5

Länge 2 [mm]: 165

CITROËN, PEUGEOT**24.2122-1740.3****010711****Hauptbremszylinder**

Durchmesser [mm]: 22,2

Anschlussanzahl: 2

MAPP-Code vorhanden:

Bremsystem: DEL

Gewindemaß 1: 1x M10x1

Gewindemaß 2: 1x M12x1

Länge 1 [mm]: 27,5

Länge 2 [mm]: 118,5

OPEL, VAUXHALL**24.2122-1741.3****010695****Hauptbremszylinder**

Durchmesser [mm]: 22,2

Gewindemaß: M10x1

Anschlussanzahl: 4

MAPP-Code vorhanden:

Länge 1 [mm]: 36

Länge 2 [mm]: 115

CITROËN, PEUGEOT

24.2122-1743.3**010712****Hauptbremszylinder**

Durchmesser [mm]: 22,2

Anschlussanzahl: 4

MAPP-Code vorhanden:

Gewindemaß 1: 2x M10x1

Gewindemaß 2: 2x M12x1

Länge 1 [mm]: 29

Länge 2 [mm]: 117

CITROËN**24.2122-1750.3****010740****Hauptbremszylinder**

Durchmesser [mm]: 22,2

Gewindemaß: M10x1

Anschlussanzahl: 4

MAPP-Code vorhanden:

Länge 1 [mm]: 29,5

Länge 2 [mm]: 120,5

FIAT**24.2122-1761.3****010822****Hauptbremszylinder**

Durchmesser [mm]: 22,2

Gewindemaß: M10x1

Anschlussanzahl: 2

MAPP-Code vorhanden:

Länge 1 [mm]: 16

Länge 2 [mm]: 154,3

HYUNDAI**24.2122-1762.3****010837****Hauptbremszylinder**

Durchmesser [mm]: 22,2

Gewindemaß: M10x1

Anschlussanzahl: 2

MAPP-Code vorhanden:

Länge 1 [mm]: 30

Länge 2 [mm]: 131

FIAT, LANCIA

24.2122-1764.3**010851****Hauptbremszylinder**

Durchmesser [mm]: 22,2

Gewindemaß: M12x1

Anschlussanzahl: 2

MAPP-Code vorhanden:

Bremsystem: BOS

Länge 1 [mm]: 26,5

Länge 2 [mm]: 138

CITROËN, PEUGEOT**24.2122-1765.3****010839****Hauptbremszylinder**

Durchmesser [mm]: 22,2

Gewindemaß: M10x1

Anschlussanzahl: 2

MAPP-Code vorhanden:

Länge 1 [mm]: 16

Länge 2 [mm]: 154

HYUNDAI**24.2122-1766.3****010840****Hauptbremszylinder**

Durchmesser [mm]: 22,2

Gewindemaß: M12x1

Anschlussanzahl: 2

MAPP-Code vorhanden:

Bremsystem: TRW

Länge 1 [mm]: 25

Länge 2 [mm]: 135

CITROËN, PEUGEOT**24.2122-1767.3****010841****Hauptbremszylinder**

Durchmesser [mm]: 22,2

Gewindemaß: M12x1

Anschlussanzahl: 3

MAPP-Code vorhanden:

Bremsystem: TRW

Ergänzungsartikel/Ergänzende Info 2: ohne Drucksensor

Länge 1 [mm]: 25

Länge 2 [mm]: 135

CITROËN, PEUGEOT

24.2122-1768.3**010853****Hauptbremszylinder**

Durchmesser [mm]: 22,2

Gewindemaß: M12x1

Anschlussanzahl: 2

MAPP-Code vorhanden:

Länge 1 [mm]: 30

Länge 2 [mm]: 131

FIAT, LANCIA**24.2122-1770.3****010898****Hauptbremszylinder**

Durchmesser [mm]: 22,2

Gewindemaß: M12x1

Anschlussanzahl: 2

MAPP-Code vorhanden:

Bremsystem: TRW

Länge 1 [mm]: 45

Länge 2 [mm]: 114

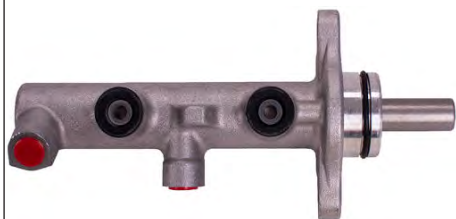
MITSUBISHI, SMART**24.2122-1774.3****010987****Hauptbremszylinder**

Durchmesser [mm]: 22,2

Gewindemaß: M12x1

Anschlussanzahl: 2

MAPP-Code vorhanden:

Ergänzungsartikel/Ergänzende Info 2: ohne Bremsflüssigkeitsbehälter

Länge 1 [mm]: 19

Länge 2 [mm]: 161

NISSAN**24.2122-1775.3****010981****Hauptbremszylinder**

Durchmesser [mm]: 22,2

Gewindemaß: M10x1

Anschlussanzahl: 4

MAPP-Code vorhanden:

Ergänzungsartikel/Ergänzende Info 2: ohne Bremsflüssigkeitsbehälter

Länge 1 [mm]: 16,5

Länge 2 [mm]: 175,5

FORD

24.2122-1776.3**011001****Hauptbremszylinder**

Durchmesser [mm]: 22,2

Gewindemaß: M10x1

Anschlussanzahl: 3

MAPP-Code vorhanden:

Ergänzungsartikel/Ergänzende Info 2: ohne Bremsflüssigkeitsbehälter

Länge 1 [mm]: 29,5

Länge 2 [mm]: 111,5

SUZUKI**24.2122-1777.3****011056****Hauptbremszylinder**

Durchmesser [mm]: 22,2

Gewindemaß: M10x1

Anschlussanzahl: 2

MAPP-Code vorhanden:

Ergänzungsartikel/Ergänzende Info 2: ohne Bremsflüssigkeitsbehälter

Länge 1 [mm]: 33

Länge 2 [mm]: 138

FIAT**24.2122-1781.3****011059****Hauptbremszylinder**

Durchmesser [mm]: 22,2

Gewindemaß: M10x1

Anschlussanzahl: 4

MAPP-Code vorhanden:

Ergänzungsartikel/Ergänzende Info 2: ohne Bremsflüssigkeitsbehälter

Länge 1 [mm]: 29,5

Länge 2 [mm]: 122,5

FIAT**24.2122-1785.3****011114****Hauptbremszylinder**

Durchmesser [mm]: 22,2

Gewindemaß: M12x1

Anschlussanzahl: 2

MAPP-Code vorhanden:

Ergänzungsartikel/Ergänzende Info 2: ohne Bremsflüssigkeitsbehälter

Länge 1 [mm]: 27,9

Länge 2 [mm]: 96

TOYOTA

24.2122-1786.3**011115****Hauptbremszylinder**

Durchmesser [mm]: 22,2

Gewindemaß: M10x1

Anschlussanzahl: 2

MAPP-Code vorhanden:

Ergänzungsartikel/Ergänzende Info 2: ohne Bremsflüssigkeitsbehälter

Länge 1 [mm]: 27,9

Länge 2 [mm]: 96

TOYOTA**24.2122-1788.3****011145****Hauptbremszylinder**

Durchmesser [mm]: 22,2

Gewindemaß: M12x1

Anschlussanzahl: 2

Material: Aluguss

MAPP-Code vorhanden:

Bremsssystem: FTE

Ergänzungsartikel/Ergänzende Info 2: ohne Bremsflüssigkeitsbehälter

Länge 1 [mm]: 24,5

Länge 2 [mm]: 140

SEAT, SKODA, VW**24.2122-1981.3****011024****Hauptbremszylinder**

Durchmesser [mm]: 22,2

Gewindemaß: M12x1

Anschlussanzahl: 2

MAPP-Code vorhanden:

Bremsssystem: ATE

Ergänzungsartikel/Ergänzende Info 2: ohne Bremsflüssigkeitsbehälter

Länge 1 [mm]: 113

Länge 2 [mm]: 66

AUDI, SEAT, SKODA, VW**24.2122-2171.3****011122****Hauptbremszylinder**

Durchmesser [mm]: 22,2

Gewindemaß: M12x1

Anschlussanzahl: 2

MAPP-Code vorhanden:

Bremsssystem: ATE

Länge 1 [mm]: 43,2

Länge 2 [mm]: 125,8

PEUGEOT

24.2123-1602.3**010384****Hauptbremszylinder**

Durchmesser [mm]: 23,8

Gewindemaß: M10x1

Anschlussanzahl: 2

MAPP-Code vorhanden:

Bremsystem: TRW

Länge 1 [mm]: 32

Länge 2 [mm]: 126,5

AUDI**24.2123-1701.3****010424****Hauptbremszylinder**

Durchmesser [mm]: 23,8

Gewindemaß: M10x1

Anschlussanzahl: 4

MAPP-Code vorhanden:

Länge 1 [mm]: 36,5

Länge 2 [mm]: 126,7

RENAULT**24.2123-1707.3****010492****Hauptbremszylinder**

Durchmesser [mm]: 23,8

Gewindemaß: M10x1

Anschlussanzahl: 4

MAPP-Code vorhanden:

Länge 1 [mm]: 36

Länge 2 [mm]: 117,5

CITROËN, FIAT, PEUGEOT**24.2123-1709.3****010503****Hauptbremszylinder**

Durchmesser [mm]: 23,8

Gewindemaß: M12x1

Anschlussanzahl: 2

MAPP-Code vorhanden:

Länge 1 [mm]: 32

Länge 2 [mm]: 122

AUDI, SEAT, SKODA, VW

24.2123-1710.3**010504****Hauptbremszylinder**

Durchmesser [mm]: 23,8

Gewindemaß: M10x1

Anschlussanzahl: 4

MAPP-Code vorhanden:

Länge 1 [mm]: 36

Länge 2 [mm]: 118

CITROËN, PEUGEOT**24.2123-1711.3****010518****Hauptbremszylinder**

Durchmesser [mm]: 23,8

Gewindemaß: M10x1

Anschlussanzahl: 2

MAPP-Code vorhanden:

Länge 1 [mm]: 35

Länge 2 [mm]: 165

MERCEDES-BENZ, VW**24.2123-1712.3****010519****Hauptbremszylinder**

Durchmesser [mm]: 23,8

Gewindemaß: M10x1

Anschlussanzahl: 4

MAPP-Code vorhanden:

Länge 1 [mm]: 36

Länge 2 [mm]: 120

MERCEDES-BENZ**24.2123-1713.3****010505****Hauptbremszylinder**

Durchmesser [mm]: 23,8

Gewindemaß: M12x1

Anschlussanzahl: 2

MAPP-Code vorhanden:

Länge 1 [mm]: 34,5

Länge 2 [mm]: 127

CITROËN, PEUGEOT

24.2123-1714.3**010587****Hauptbremszylinder**

Durchmesser [mm]: 23,8

Anschlussanzahl: 4

MAPP-Code vorhanden:

Bremsystem: BDX

Gewindemaß 1: 2x M10x1

Gewindemaß 2: 2x M12x1

Länge 1 [mm]: 33

Länge 2 [mm]: 120,5

CITROËN, PEUGEOT**24.2123-1715.3****010520****Hauptbremszylinder**

Durchmesser [mm]: 23,8

Anschlussanzahl: 2

MAPP-Code vorhanden:

Bremsystem: BDX

Gewindemaß 1: 1x M10x1

Gewindemaß 2: 1x M12x1

Länge 1 [mm]: 33

Länge 2 [mm]: 120,5

CITROËN, PEUGEOT**24.2123-1717.3****010521****Hauptbremszylinder**

Durchmesser [mm]: 23,8

Gewindemaß: M12x1

Anschlussanzahl: 2

MAPP-Code vorhanden:

Länge 1 [mm]: 39,5

Länge 2 [mm]: 121,5

AUDI, PORSCHE, VW**24.2123-1724.3****010566****Hauptbremszylinder**

Durchmesser [mm]: 23,8

Anschlussanzahl: 3

MAPP-Code vorhanden:

Bremsystem: BDX

Gewindemaß 1: 2x M10x1

Gewindemaß 2: 1x M12x1

Länge 1 [mm]: 10

Länge 2 [mm]: 203

FORD

24.2123-1725.3**010549****Hauptbremszylinder**

Durchmesser [mm]: 23,8

Anschlussanzahl: 4

MAPP-Code vorhanden:

Gewindemaß 1: 2x M10x1

Gewindemaß 2: 2x M12x1

Länge 1 [mm]: 36,5

Länge 2 [mm]: 126,5

RENAULT**24.2123-1728.3****010558****Hauptbremszylinder**

Durchmesser [mm]: 23,8

Gewindemaß: M10x1

Anschlussanzahl: 2

MAPP-Code vorhanden:

Länge 1 [mm]: 36

Länge 2 [mm]: 128

VW**24.2123-1729.3****010567****Hauptbremszylinder**

Durchmesser [mm]: 23,8

Gewindemaß: M10x1

Anschlussanzahl: 2

MAPP-Code vorhanden:

Länge 1 [mm]: 35

Länge 2 [mm]: 150,8

MERCEDES-BENZ**24.2123-1730.3****010620****Hauptbremszylinder**

Durchmesser [mm]: 23,8

Anschlussanzahl: 2

MAPP-Code vorhanden:

Gewindemaß 1: 1x M10x1

Gewindemaß 2: 1x M12x1

Länge 1 [mm]: 39,5

Länge 2 [mm]: 120,5

AUDI, PORSCHE, VW

24.2123-1732.3**010625****Hauptbremszylinder**

Durchmesser [mm]: 23,8

Gewindemaß: M10x1

Anschlussanzahl: 4

MAPP-Code vorhanden:

Ergänzungsartikel/Ergänzende Info 2: ohne Bremsflüssigkeitsbehälter

Länge 1 [mm]: 36

Länge 2 [mm]: 105,5

FORD**24.2123-1733.3****010657****Hauptbremszylinder**

Durchmesser [mm]: 23,8

Gewindemaß: M10x1

Anschlussanzahl: 2

MAPP-Code vorhanden:

Bremsystem: BOS

Länge 1 [mm]: 36,5

Länge 2 [mm]: 126,7

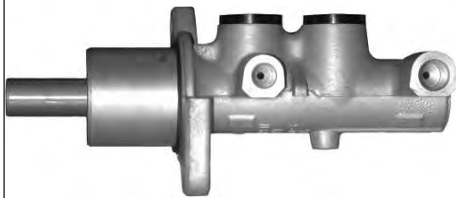
CITROËN, FIAT, LANCIA, PEUGEOT**24.2123-1734.3****010640****Hauptbremszylinder**

Durchmesser [mm]: 23,8

Anschlussanzahl: 2

MAPP-Code vorhanden:

Bremsystem: TRW

Gewindemaß 1: 1x M10x1

Gewindemaß 2: 1x M12x1

Länge 1 [mm]: 39,5

Länge 2 [mm]: 119,5

CHEVROLET, OPEL, VAUXHALL**24.2123-1738.3****010658****Hauptbremszylinder**

Durchmesser [mm]: 23,8

Gewindemaß: M10x1

Anschlussanzahl: 4

MAPP-Code vorhanden:

Länge 1 [mm]: 36

Länge 2 [mm]: 118,5

CITROËN, FIAT, PEUGEOT

24.2123-1739.3**010661****Hauptbremszylinder**

Durchmesser [mm]: 23,8

Gewindemaß: M12x1

Anschlussanzahl: 2

MAPP-Code vorhanden:

Länge 1 [mm]: 39,5

Länge 2 [mm]: 121

CHEVROLET, OPEL, VAUXHALL**24.2123-1741.3****010681****Hauptbremszylinder**

Durchmesser [mm]: 23,8

Gewindemaß: M12x1

Anschlussanzahl: 2

MAPP-Code vorhanden:

Länge 1 [mm]: 33

Länge 2 [mm]: 127

PEUGEOT**24.2123-1742.3****010671****Hauptbremszylinder**

Durchmesser [mm]: 23,8

Gewindemaß: M12x1

Anschlussanzahl: 2

MAPP-Code vorhanden:

Länge 1 [mm]: 33

Länge 2 [mm]: 121

FORD**24.2123-1746.3****010682****Hauptbremszylinder**

Durchmesser [mm]: 23,8

Gewindemaß: M10x1

Anschlussanzahl: 2

MAPP-Code vorhanden:

Länge 1 [mm]: 36,5

Länge 2 [mm]: 116,5

VOLVO

24.2123-1749.3**010713****Hauptbremszylinder**

Durchmesser [mm]: 23,8

Gewindemaß: M10x1

Anschlussanzahl: 2

MAPP-Code vorhanden:

Länge 1 [mm]: 33

Länge 2 [mm]: 120

FORD**24.2123-1751.3****010698****Hauptbremszylinder**

Durchmesser [mm]: 23,8

Gewindemaß: M10x1

Anschlussanzahl: 4

MAPP-Code vorhanden:

Länge 1 [mm]: 36

Länge 2 [mm]: 118

PEUGEOT**24.2123-1754.3****010741****Hauptbremszylinder**

Durchmesser [mm]: 23,8

Gewindemaß: M12x1

Anschlussanzahl: 2

MAPP-Code vorhanden:

Länge 1 [mm]: 67

Länge 2 [mm]: 111,5

MERCEDES-BENZ**24.2123-1755.3****010750****Hauptbremszylinder**

Durchmesser [mm]: 23,8

Gewindemaß: M10x1

Anschlussanzahl: 2

MAPP-Code vorhanden:

Länge 1 [mm]: 67

Länge 2 [mm]: 110

VW

24.2123-1759.3**010768****Hauptbremszylinder**

Durchmesser [mm]: 23,8

Gewindemaß: M12x1

Anschlussanzahl: 2

MAPP-Code vorhanden:

Bremsystem: BOS

Länge 1 [mm]: 39

Länge 2 [mm]: 143,2

NISSAN, OPEL, RENAULT, VAUXHALL**24.2123-1760.3****010779****Hauptbremszylinder**

Durchmesser [mm]: 23,8

Gewindemaß: M12x1

Anschlussanzahl: 2

MAPP-Code vorhanden:

Bremsystem: TRW

Länge 1 [mm]: 25

Länge 2 [mm]: 155

RENAULT**24.2123-1762.3****010823****Hauptbremszylinder**

Durchmesser [mm]: 23,8

Gewindemaß: M10x1

Anschlussanzahl: 2

MAPP-Code vorhanden:

Länge 1 [mm]: 15

Länge 2 [mm]: 161

HYUNDAI**24.2123-1763.3****010842****Hauptbremszylinder**

Durchmesser [mm]: 23,8

Gewindemaß: M10x1

Anschlussanzahl: 2

MAPP-Code vorhanden:

Länge 1 [mm]: 32,5

Länge 2 [mm]: 131

FIAT, LANCIA

24.2123-1764.3**010824****Hauptbremszylinder**

Durchmesser [mm]: 23,8

Anschlussanzahl: 2

MAPP-Code vorhanden:

Bremsystem: TRW

Gewindemaß 1: 1x M10x1

Gewindemaß 2: 1x M12x1

Länge 1 [mm]: 29

Länge 2 [mm]: 132

OPEL, VAUXHALL**24.2123-1766.3****010825****Hauptbremszylinder**

Durchmesser [mm]: 23,8

Gewindemaß: M12x1

Anschlussanzahl: 2

MAPP-Code vorhanden:

Bremsystem: TRW

Länge 1 [mm]: 40

Länge 2 [mm]: 121

PORSCHE**24.2123-1767.3****010844****Hauptbremszylinder**

Durchmesser [mm]: 23,8

Gewindemaß: M10x1

Anschlussanzahl: 2

MAPP-Code vorhanden:

Bremsystem: BOS

Länge 1 [mm]: 31

Länge 2 [mm]: 131

OPEL, VAUXHALL**24.2123-1771.3****010857****Hauptbremszylinder**

Durchmesser [mm]: 23,8

Gewindemaß: M14x1,5

Anschlussanzahl: 2

MAPP-Code vorhanden:

Bremsystem: BOS

Ergänzungsartikel/Ergänzende Info 2: ohne Bremsflüssigkeitsbehälter

Länge 1 [mm]: 37

Länge 2 [mm]: 131

TOYOTA

24.2123-1772.3**010858****Hauptbremszylinder**

Durchmesser [mm]: 23,8

Gewindemaß: M12x1

Anschlussanzahl: 2

MAPP-Code vorhanden:

Bremsystem: BOS

Länge 1 [mm]: 73

Länge 2 [mm]: 122

MERCEDES-BENZ**24.2123-1776.3****010926****Hauptbremszylinder**

Durchmesser [mm]: 23,8

Gewindemaß: M12x1

Anschlussanzahl: 2

MAPP-Code vorhanden:

Bremsystem: TRW

Länge 1 [mm]: 40

Länge 2 [mm]: 115

MERCEDES-BENZ**24.2123-1777.3****010943****Hauptbremszylinder**

Durchmesser [mm]: 23,8

Anschlussanzahl: 2

MAPP-Code vorhanden:

Gewindemaß 1: 1x M10x1

Gewindemaß 2: 1x M12x1

Länge 1 [mm]: 39,5

Länge 2 [mm]: 120,5

OPEL, VAUXHALL**24.2123-1778.3****010947****Hauptbremszylinder**

Durchmesser [mm]: 23,8

Gewindemaß: M12x1

Anschlussanzahl: 2

MAPP-Code vorhanden:

Bremsystem: TRW

Länge 1 [mm]: 72

Länge 2 [mm]: 122

MERCEDES-BENZ

24.2123-1779.3**011078****Hauptbremszylinder**

Durchmesser [mm]: 23,8

Gewindemaß: M12x1

Anschlussanzahl: 2

Material: Aluguss

MAPP-Code vorhanden:

Ergänzungsartikel/Ergänzende Info 2: ohne Bremsflüssigkeitsbehälter

Länge 1 [mm]: 36

Länge 2 [mm]: 135

FORD**24.2123-1780.3****011081****Hauptbremszylinder**

Durchmesser [mm]: 23,8

Gewindemaß: M12x1

Anschlussanzahl: 2

Material: Aluguss

MAPP-Code vorhanden:

Ergänzungsartikel/Ergänzende Info 2: ohne Bremsflüssigkeitsbehälter

Länge 1 [mm]: 41

Länge 2 [mm]: 104

SMART**24.2123-1781.3****011060****Hauptbremszylinder**

Durchmesser [mm]: 23,8

Gewindemaß: 7/16 -24 UNS

Anschlussanzahl: 2

MAPP-Code vorhanden:

Ergänzungsartikel/Ergänzende Info 2: ohne Bremsflüssigkeitsbehälter

Länge 1 [mm]: 73

Länge 2 [mm]: 152,6

CHRYSLER**24.2123-1782.3****011146****Hauptbremszylinder**

Durchmesser [mm]: 23,8

Gewindemaß: M12x1

Anschlussanzahl: 2

Material: Aluguss

MAPP-Code vorhanden:

Bremsystem: TRW

Ergänzungsartikel/Ergänzende Info 2: ohne Bremsflüssigkeitsbehälter

Länge 1 [mm]: 5

Länge 2 [mm]: 130,4

AUDI, SEAT, SKODA, VW

24.2123-1783.3**011132****Hauptbremszylinder**

Durchmesser [mm]: 23,8

Gewindemaß: M12x1

Anschlussanzahl: 2

Material: Aluguss

MAPP-Code vorhanden:

Bremsystem: FTE

Ergänzungsartikel/Ergänzende Info 2: ohne Bremsflüssigkeitsbehälter

Länge 1 [mm]: 29,5

Länge 2 [mm]: 120,4

VW**24.2123-1784.3****011164****Hauptbremszylinder**

Durchmesser [mm]: 23,8

Gewindemaß: M12x1

Anschlussanzahl: 2

Material: Aluguss

MAPP-Code vorhanden:

Bremsystem: BOS

Ergänzungsartikel/Ergänzende Info 2: ohne Bremsflüssigkeitsbehälter

Länge 1 [mm]: 28

Länge 2 [mm]: 136

OPEL, VAUXHALL**24.2123-3041.3****011021****Hauptbremszylinder**

Durchmesser [mm]: 23,8

Gewindemaß: M10x1

Anschlussanzahl: 4

MAPP-Code vorhanden:

Bremsystem: ATE

Ergänzungsartikel/Ergänzende Info 2: ohne Bremsflüssigkeitsbehälter / ohne Druckregler

Länge 1 [mm]: 41,5

Länge 2 [mm]: 101,7

FORD**24.2123-3131.3****011123****Hauptbremszylinder**

Durchmesser [mm]: 23,8

Gewindemaß: M12x1

Anschlussanzahl: 2

MAPP-Code vorhanden:

Bremsystem: ATE

Länge 1 [mm]: 43,2

Länge 2 [mm]: 125,8

CITROËN, PEUGEOT

24.2123-3396.3**011035****Hauptbremszylinder**

Durchmesser [mm]: 23,8

Gewindemaß: M10x1

Anschlussanzahl: 2

MAPP-Code vorhanden:

Bremsystem: ATE

Ergänzungsartikel/Ergänzende Info 2: ohne Bremsflüssigkeitsbehälter

Länge 1 [mm]: 33,2

Länge 2 [mm]: 137,3

CITROËN, PEUGEOT**24.2125-1702.3****010482****Hauptbremszylinder**

Durchmesser [mm]: 25,4

Gewindemaß: M10x1

Anschlussanzahl: 2

MAPP-Code vorhanden:

Länge 1 [mm]: 19

Länge 2 [mm]: 173,5

CITROËN, FIAT, PEUGEOT**24.2125-1703.3****010483****Hauptbremszylinder**

Durchmesser [mm]: 25,4

Gewindemaß: M10x1

Anschlussanzahl: 5

MAPP-Code vorhanden:

Länge 1 [mm]: 9

Länge 2 [mm]: 168

CITROËN, FIAT, OPEL, PEUGEOT, VAUXHALL**24.2125-1704.3****010446****Hauptbremszylinder**

Durchmesser [mm]: 25,4

Anschlussanzahl: 2

MAPP-Code vorhanden:

Bremsystem: TRW

Gewindemaß 1: 1x M10x1

Gewindemaß 2: 1x M12x1

Länge 1 [mm]: 15,5

Länge 2 [mm]: 189

OPEL, VAUXHALL

24.2125-1709.3**010499****Hauptbremszylinder**

Durchmesser [mm]: 25,4

Gewindemaß: M12x1

Anschlussanzahl: 2

MAPP-Code vorhanden:

Länge 1 [mm]: 38

Länge 2 [mm]: 125

FORD**24.2125-1712.3****010622****Hauptbremszylinder**

Durchmesser [mm]: 25,4

Gewindemaß: M12x1

Anschlussanzahl: 2

MAPP-Code vorhanden:

Länge 1 [mm]: 49,5

Länge 2 [mm]: 111,5

AUDI, VW**24.2125-1713.3****010623****Hauptbremszylinder**

Durchmesser [mm]: 25,4

Anschlussanzahl: 2

MAPP-Code vorhanden:

Gewindemaß 1: 1x M10x1

Gewindemaß 2: 1x M12x1

Länge 1 [mm]: 49

Länge 2 [mm]: 111

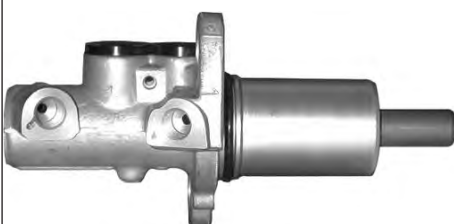
AUDI, VW**24.2125-1720.3****010688****Hauptbremszylinder**

Durchmesser [mm]: 25,4

Gewindemaß: M12x1

Anschlussanzahl: 2

MAPP-Code vorhanden:

Bremsystem: TRW

Länge 1 [mm]: 69,5

Länge 2 [mm]: 92

AUDI, SEAT, SKODA, VW

24.2125-1721.3**010673****Hauptbremszylinder**

Durchmesser [mm]: 25,4

Anschlussanzahl: 4

MAPP-Code vorhanden:

Gewindemaß 1: 2x M10x1

Gewindemaß 2: 2x M12x1

Ergänzungsartikel/Ergänzende Info 2: ohne Bremsflüssigkeitsbehälter

Länge 1 [mm]: 43

Länge 2 [mm]: 110,5

FORD**24.2125-1722.3****010674****Hauptbremszylinder**

Durchmesser [mm]: 25,4

Gewindemaß: M12x1

Anschlussanzahl: 2

MAPP-Code vorhanden:

Ergänzungsartikel/Ergänzende Info 2: ohne Bremsflüssigkeitsbehälter

Länge 1 [mm]: 42,5

Länge 2 [mm]: 110,5

FORD**24.2125-1726.3****010718****Hauptbremszylinder**

Durchmesser [mm]: 25,4

Gewindemaß: M10x1

Anschlussanzahl: 2

MAPP-Code vorhanden:

Länge 1 [mm]: 33

Länge 2 [mm]: 147

CITROËN, FIAT, PEUGEOT**24.2125-1727.3****010723****Hauptbremszylinder**

Durchmesser [mm]: 25,4

Gewindemaß: M10x1

Anschlussanzahl: 2

MAPP-Code vorhanden:

Länge 1 [mm]: 35

Länge 2 [mm]: 165,3

MERCEDES-BENZ, VW

24.2125-1728.3**010751****Hauptbremszylinder**

Durchmesser [mm]: 25,4

Gewindemaß: M12x1

Anschlussanzahl: 2

MAPP-Code vorhanden:

Länge 1 [mm]: 67

Länge 2 [mm]: 111,5

MERCEDES-BENZ**24.2125-1729.3****010752****Hauptbremszylinder**

Durchmesser [mm]: 25,4

Gewindemaß: M12x1

Anschlussanzahl: 2

MAPP-Code vorhanden:

Länge 1 [mm]: 47

Länge 2 [mm]: 114

ALFA ROMEO**24.2125-1731.3****010826****Hauptbremszylinder**

Durchmesser [mm]: 25,4

Gewindemaß: M12x1

Anschlussanzahl: 2

MAPP-Code vorhanden:

Bremsssystem: TRW

Länge 1 [mm]: 47,5

Länge 2 [mm]: 113

NISSAN, OPEL, RENAULT, VAUXHALL**24.2125-1732.3****010827****Hauptbremszylinder**

Durchmesser [mm]: 25,4

Gewindemaß: M12x1

Anschlussanzahl: 2

MAPP-Code vorhanden:

Bremsssystem: TRW

Länge 1 [mm]: 40

Länge 2 [mm]: 122

ALFA ROMEO, CHEVROLET, FIAT, OPEL, SAAB, VAUXHALL

24.2125-1735.3**010879****Hauptbremszylinder**

Durchmesser [mm]: 25,4

Gewindemaß: M10x1

Anschlussanzahl: 2

MAPP-Code vorhanden:

Bremsystem: TRW

Länge 1 [mm]: 67

Länge 2 [mm]: 111,5

VW**24.2125-1736.3****010904****Hauptbremszylinder**

Durchmesser [mm]: 25,4

Gewindemaß: M12x1

Anschlussanzahl: 2

MAPP-Code vorhanden:

Bremsystem: TRW

Länge 1 [mm]: 31

Länge 2 [mm]: 129

OPEL, VAUXHALL**24.2125-1737.3****010906****Hauptbremszylinder**

Durchmesser [mm]: 25,4

Anschlussanzahl: 2

MAPP-Code vorhanden:

Bremsystem: TRW

Gewindemaß 1: M10x1

Gewindemaß 2: M12x1

Länge 1 [mm]: 31

Länge 2 [mm]: 129

OPEL, VAUXHALL**24.2125-1739.3****010948****Hauptbremszylinder**

Durchmesser [mm]: 25,4

Gewindemaß: M12x1

Anschlussanzahl: 2

MAPP-Code vorhanden:

Bremsystem: TRW

Länge 1 [mm]: 69

Länge 2 [mm]: 90

AUDI

24.2125-1740.3**010971****Hauptbremszylinder**

Durchmesser [mm]: 25,4

Gewindemaß: M12x1

Anschlussanzahl: 2

MAPP-Code vorhanden:

Bremsystem: TRW

Länge 1 [mm]: 47

Länge 2 [mm]: 113

OPEL, VAUXHALL**24.2125-1741.3****010988****Hauptbremszylinder**

Durchmesser [mm]: 25,4

Gewindemaß: M10x1

Anschlussanzahl: 2

MAPP-Code vorhanden:

Ergänzungsartikel/Ergänzende Info 2: ohne Bremsflüssigkeitsbehälter

Länge 1 [mm]: 15,7

Länge 2 [mm]: 152,5

NISSAN**24.2125-1742.3****010978****Hauptbremszylinder**

Durchmesser [mm]: 25,4

Gewindemaß: M12x1

Anschlussanzahl: 2

MAPP-Code vorhanden:

Bremsystem: TRW

Länge 1 [mm]: 25,3

Länge 2 [mm]: 157

RENAULT**24.2125-1745.3****010998****Hauptbremszylinder**

Durchmesser [mm]: 25,4

Gewindemaß: M12x1

Anschlussanzahl: 2

MAPP-Code vorhanden:

Bremsystem: TRW

Länge 1 [mm]: 75

Länge 2 [mm]: 134,6

MERCEDES-BENZ

24.2125-1747.3**011029****Hauptbremszylinder**

Durchmesser [mm]: 25,4

Gewindemaß: M10x1

Anschlussanzahl: 2

Material: Aluguss

MAPP-Code vorhanden:

Länge 1 [mm]: 18,5

Länge 2 [mm]: 142,4

FORD, MAZDA**24.2125-1748.3****011030****Hauptbremszylinder**

Durchmesser [mm]: 25,4

Gewindemaß: M12x1

Anschlussanzahl: 2

Material: Aluguss

MAPP-Code vorhanden:

Bremsystem: TRW

Länge 1 [mm]: 70,5

Länge 2 [mm]: 140,5

MERCEDES-BENZ**24.2125-1749.3****011031****Hauptbremszylinder**

Durchmesser [mm]: 25,4

Gewindemaß: M12x1

Anschlussanzahl: 2

Material: Aluguss

MAPP-Code vorhanden:

Bremsystem: TRW

Länge 1 [mm]: 66,5

Länge 2 [mm]: 93

AUDI**24.2125-1750.3****011050****Hauptbremszylinder**

Durchmesser [mm]: 25,4

Gewindemaß: M12x1

Anschlussanzahl: 2

Material: Aluguss

MAPP-Code vorhanden:

Ergänzungsartikel/Ergänzende Info 2: ohne Bremsflüssigkeitsbehälter

Länge 1 [mm]: 73,5

Länge 2 [mm]: 124,5

MERCEDES-BENZ, VW

24.2125-1752.3

011134

**Hauptbremszylinder**

Durchmesser [mm]: 25,4

Gewindemaß: M12x1

Anschlussanzahl: 2

Material: ALU

MAPP-Code vorhanden:

Bremsystem: TRW

Ergänzungsartikel/Ergänzende Info 2: ohne Bremsflüssigkeitsbehälter

Länge 1 [mm]: 66

Länge 2 [mm]: 70

AUDI

24.2126-1702.3

010950

**Hauptbremszylinder**

Durchmesser [mm]: 27

Gewindemaß: M10x1

Anschlussanzahl: 2

MAPP-Code vorhanden:

Länge 1 [mm]: 19

Länge 2 [mm]: 133

KIA

24.2126-1704.3

010990

**Hauptbremszylinder**

Durchmesser [mm]: 27

Gewindemaß: M12x1

Anschlussanzahl: 2

MAPP-Code vorhanden:

Bremsystem: TRW

Länge 1 [mm]: 72

Länge 2 [mm]: 120

MERCEDES-BENZ, VW

24.2126-1705.3

010999

**Hauptbremszylinder**

Durchmesser [mm]: 27

Gewindemaß: M12x1

Anschlussanzahl: 2

MAPP-Code vorhanden:

Bremsystem: TRW

Länge 1 [mm]: 90,5

Länge 2 [mm]: 69,3

AUDI

24.2126-1706.3**011062****Hauptbremszylinder**

Durchmesser [mm]: 26

Gewindemaß: 7/16-24 UNS

Anschlussanzahl: 2

Material: Aluguss

MAPP-Code vorhanden:

Ergänzungsartikel/Ergänzende Info 2: ohne Bremsflüssigkeitsbehälter

Länge 1 [mm]: 73

Länge 2 [mm]: 152,6

CHRYSLER**24.2126-1707.3****011061****Hauptbremszylinder**

Durchmesser [mm]: 26

Gewindemaß: M12x1

Anschlussanzahl: 2

Material: Aluguss

MAPP-Code vorhanden:

Ergänzungsartikel/Ergänzende Info 2: ohne Bremsflüssigkeitsbehälter

Länge 1 [mm]: 73

Länge 2 [mm]: 152,6

CHRYSLER**24.2126-1708.3****011128****Hauptbremszylinder**

Durchmesser [mm]: 27

Gewindemaß: M12x1

Anschlussanzahl: 2

Material: Aluguss

MAPP-Code vorhanden:

Ergänzungsartikel/Ergänzende Info 2: ohne Bremsflüssigkeitsbehälter

Länge 1 [mm]: 51

Länge 2 [mm]: 141,2

MERCEDES-BENZ, VW**24.2126-3032.3****011036****Hauptbremszylinder**

Durchmesser [mm]: 27

Gewindemaß: M12x1

Anschlussanzahl: 2

MAPP-Code vorhanden:

Bremsystem: ATE

Ergänzungsartikel/Ergänzende Info 2: ohne Bremsflüssigkeitsbehälter

Länge 1 [mm]: 18,7

Länge 2 [mm]: 133,5

PORSCHE, VW

24.2126-3071.3**011037****Hauptbremszylinder**

Durchmesser [mm]: 27

Gewindemaß: M12x1

Anschlussanzahl: 2

MAPP-Code vorhanden:

Bremsystem: ATE

Ergänzungsartikel/Ergänzende Info 2: ohne Bremsflüssigkeitsbehälter

Länge 1 [mm]: 23,3

Länge 2 [mm]: 128,9

AUDI**24.2126-3131.3****011038****Hauptbremszylinder**

Durchmesser [mm]: 27

Gewindemaß: M12x1

Anschlussanzahl: 2

MAPP-Code vorhanden:

Bremsystem: ATE

Ergänzungsartikel/Ergänzende Info 2: ohne Bremsflüssigkeitsbehälter

Länge 1 [mm]: 37,2

Länge 2 [mm]: 139,8

VW**24.2127-0901.3****011139****Hauptbremszylinder**

Durchmesser [mm]: 27

Gewindemaß: M12x1

Anschlussanzahl: 3

Material: ALU

MAPP-Code vorhanden:

Bremsystem: ATE

Ergänzungsartikel/Ergänzende Info 2: ohne Bremsflüssigkeitsbehälter

Länge 1 [mm]: 55,5

Länge 2 [mm]: 114,3

MERCEDES-BENZ**24.4025-1701.3****010719****Hauptbremszylinder**

Durchmesser [mm]: 25,4

Gewindemaß: M12x1

Anschlussanzahl: 2

MAPP-Code vorhanden:

Länge 1 [mm]: 51

Länge 2 [mm]: 67,2

MERCEDES-BENZ

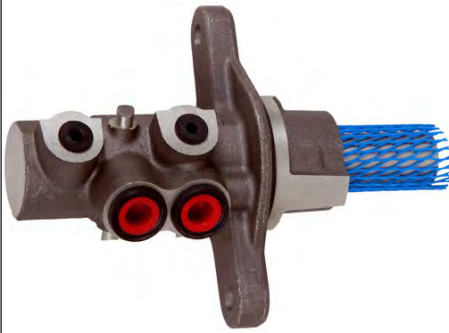
24.4120-1701.3**010846****Hauptbremszylinder**

Durchmesser [mm]: 20,6

Gewindemaß: M10x1

Anschlussanzahl: 2

MAPP-Code vorhanden:

Bremsystem: BOS

Länge 1 [mm]: 32

Länge 2 [mm]: 86,3

CITROËN, PEUGEOT, TOYOTA**24.4120-1702.3****010913****Hauptbremszylinder**

Durchmesser [mm]: 20,6

Gewindemaß: M10x1

Anschlussanzahl: 2

MAPP-Code vorhanden:

Bremsystem: TRW

Ergänzungsartikel/Ergänzende Info 2: ohne Bremsflüssigkeitsbehälter

Länge 1 [mm]: 6

Länge 2 [mm]: 119

FIAT**24.4120-1703.3****011015****Hauptbremszylinder**

Durchmesser [mm]: 20,6

Gewindemaß: M12x1

Anschlussanzahl: 2

MAPP-Code vorhanden:

Bremsystem: TRW

Ergänzungsartikel/Ergänzende Info 2: ohne Bremsflüssigkeitsbehälter

Länge 1 [mm]: 11,3

Länge 2 [mm]: 107

SEAT, SKODA, VW**24.4120-1704.3****011042****Hauptbremszylinder**

Durchmesser [mm]: 20,6

Gewindemaß: M12x1

Anschlussanzahl: 2

Material: Aluguss

MAPP-Code vorhanden:

Ergänzungsartikel/Ergänzende Info 2: ohne Bremsflüssigkeitsbehälter

Länge 1 [mm]: 32

Länge 2 [mm]: 85

CITROËN, PEUGEOT, TOYOTA

24.4120-1705.3**011051****Hauptbremszylinder**

Durchmesser [mm]: 20,6

Gewindemaß: M12x1

Anschlussanzahl: 2

Material: Aluguss

MAPP-Code vorhanden:

Ergänzungsartikel/Ergänzende Info 2: ohne Bremsflüssigkeitsbehälter

Länge 1 [mm]: 32

Länge 2 [mm]: 86

CITROËN, PEUGEOT, TOYOTA**24.4120-1706.3****011072****Hauptbremszylinder**

Durchmesser [mm]: 20,6

Gewindemaß: M10x1

Anschlussanzahl: 2

Material: Aluguss

MAPP-Code vorhanden:

Ergänzungsartikel/Ergänzende Info 2: ohne Bremsflüssigkeitsbehälter

Länge 1 [mm]: 5,5

Länge 2 [mm]: 110,5

FORD**24.4120-1708.3****011084****Hauptbremszylinder**

Durchmesser [mm]: 20,6

Gewindemaß: M12x1

Anschlussanzahl: 2

Material: Aluguss

MAPP-Code vorhanden:

Ergänzungsartikel/Ergänzende Info 2: ohne Bremsflüssigkeitsbehälter

Länge 1 [mm]: 32

Länge 2 [mm]: 85,4

TOYOTA**24.4120-1710.3****011082****Hauptbremszylinder**

Durchmesser [mm]: 20,6

Gewindemaß: M12x1

Anschlussanzahl: 2

Material: Aluguss

MAPP-Code vorhanden:

Ergänzungsartikel/Ergänzende Info 2: ohne Bremsflüssigkeitsbehälter

Länge 1 [mm]: 32

Länge 2 [mm]: 87,4

FORD

24.4120-1711.3**011093****Hauptbremszylinder**

Durchmesser [mm]: 20,6

Gewindemaß: M10x1

Anschlussanzahl: 2

Material: Aluguss

MAPP-Code vorhanden:

Ergänzungsartikel/Ergänzende Info 2: ohne Bremsflüssigkeitsbehälter

Länge 1 [mm]: 32

Länge 2 [mm]: 87,4

FORD**24.4120-1712.3****011092****Hauptbremszylinder**

Durchmesser [mm]: 20,6

Gewindemaß: M10x1

Anschlussanzahl: 2

Material: Aluguss

MAPP-Code vorhanden:

Ergänzungsartikel/Ergänzende Info 2: ohne Bremsflüssigkeitsbehälter

Länge 1 [mm]: 32

Länge 2 [mm]: 85,4

CITROËN, PEUGEOT, TOYOTA**24.4120-1713.3****011102****Hauptbremszylinder**

Durchmesser [mm]: 20,6

Gewindemaß: M12x1

Anschlussanzahl: 2

Material: Aluguss

MAPP-Code vorhanden:

Ergänzungsartikel/Ergänzende Info 2: ohne Bremsflüssigkeitsbehälter

Länge 1 [mm]: 12

Länge 2 [mm]: 96,9

HYUNDAI**24.4120-1714.3****011110****Hauptbremszylinder**

Durchmesser [mm]: 20,6

Gewindemaß: M10x1

Anschlussanzahl: 4

Material: Aluguss

MAPP-Code vorhanden:

Ergänzungsartikel/Ergänzende Info 2: ohne Bremsflüssigkeitsbehälter

Länge 1 [mm]: 5

Länge 2 [mm]: 116

DACIA, RENAULT

24.4120-1771.3**011076****Hauptbremszylinder**

Durchmesser [mm]: 20,6

Gewindemaß: M12x1

Anschlussanzahl: 2

Material: Aluguss

MAPP-Code vorhanden:

Ergänzungsartikel/Ergänzende Info 2: ohne Bremsflüssigkeitsbehälter

Länge 1 [mm]: 1

Länge 2 [mm]: 111

DACIA, RENAULT**24.4122-1701.3****010533****Hauptbremszylinder**

Durchmesser [mm]: 22,2

Gewindemaß: M12x1

Anschlussanzahl: 2

MAPP-Code vorhanden:

Bremsystem: TRW

Länge 1 [mm]: 10,2

Länge 2 [mm]: 109

MERCEDES-BENZ**24.4122-1703.3****010843****Hauptbremszylinder**

Durchmesser [mm]: 22,2

Gewindemaß: M12x1

Anschlussanzahl: 2

MAPP-Code vorhanden:

Bremsystem: TRW

Länge 1 [mm]: 32

Länge 2 [mm]: 112

CITROËN, PEUGEOT**24.4122-1704.3****010847****Hauptbremszylinder**

Durchmesser [mm]: 22,2

Gewindemaß: M10x1

Anschlussanzahl: 2

MAPP-Code vorhanden:

Bremsystem: TRW

Länge 1 [mm]: 6

Länge 2 [mm]: 112

CITROËN, PEUGEOT

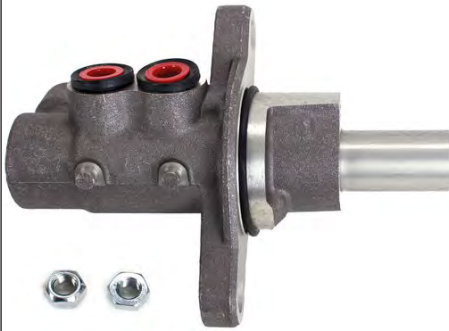
24.4122-1705.3**010852****Hauptbremszylinder**

Durchmesser [mm]: 22,2

Gewindemaß: M12x1

Anschlussanzahl: 2

MAPP-Code vorhanden:

Bremsystem: BOS

Ergänzungsartikel/Ergänzende Info 2: ohne Bremsflüssigkeitsbehälter

Länge 1 [mm]: 32

Länge 2 [mm]: 80

OPEL, VAUXHALL**24.4122-1708.3****010865****Hauptbremszylinder**

Durchmesser [mm]: 22,2

Gewindemaß: M10x1

Anschlussanzahl: 2

MAPP-Code vorhanden:

Bremsystem: BOS

Ergänzungsartikel/Ergänzende Info 2: ohne Bremsflüssigkeitsbehälter

Länge 1 [mm]: 20

Länge 2 [mm]: 95

CITROËN**24.4122-1709.3****010871****Hauptbremszylinder**

Durchmesser [mm]: 22,2

Gewindemaß: M10x1

Anschlussanzahl: 2

MAPP-Code vorhanden:

Bremsystem: BOS

Ergänzungsartikel/Ergänzende Info 2: ohne Bremsflüssigkeitsbehälter

Länge 1 [mm]: 32

Länge 2 [mm]: 78

ALFA ROMEO, FIAT, OPEL, VAUXHALL**24.4122-1712.3****010899****Hauptbremszylinder**

Durchmesser [mm]: 22,2

Gewindemaß: M10x1

Anschlussanzahl: 2

MAPP-Code vorhanden:

Ergänzungsartikel/Ergänzende Info 2: ohne Bremsflüssigkeitsbehälter

Bremsystem: BOS

FIAT, SUZUKI

24.4122-1713.3**010900****Hauptbremszylinder**

Durchmesser [mm]: 22,2

Gewindemaß: M12x1

Anschlussanzahl: 2

MAPP-Code vorhanden:

Ergänzungsartikel/Ergänzende Info 2: ohne Bremsflüssigkeitsbehälter

Bremsystem: BOS

FIAT, SUZUKI**24.4122-1714.3****010914****Hauptbremszylinder**

Durchmesser [mm]: 22,2

Gewindemaß: M10x1

Anschlussanzahl: 2

MAPP-Code vorhanden:

Bremsystem: TRW

Ergänzungsartikel/Ergänzende Info 2: ohne Bremsflüssigkeitsbehälter

Länge 1 [mm]: 6

Länge 2 [mm]: 119

ABARTH, FIAT**24.4122-1717.3****010993****Hauptbremszylinder**

Durchmesser [mm]: 22,2

Gewindemaß: M12x1

Anschlussanzahl: 2

MAPP-Code vorhanden:

Bremsystem: TRW

Ergänzungsartikel/Ergänzende Info 2: ohne Bremsflüssigkeitsbehälter

Länge 1 [mm]: 10,8

Länge 2 [mm]: 109

MITSUBISHI**24.4122-1718.3****011019****Hauptbremszylinder**

Durchmesser [mm]: 22,2

Gewindemaß: M10x1

Anschlussanzahl: 2

MAPP-Code vorhanden:

Bremsystem: BOS

Ergänzungsartikel/Ergänzende Info 2: ohne Bremsflüssigkeitsbehälter

Länge 1 [mm]: 20

Länge 2 [mm]: 91,8

OPEL, SUZUKI, VAUXHALL

24.4122-1719.3**011020****Hauptbremszylinder**

Durchmesser [mm]: 22,2

Gewindemaß: M12x1

Anschlussanzahl: 2

MAPP-Code vorhanden:

Ergänzungsartikel/Ergänzende Info 2: ohne Bremsflüssigkeitsbehälter

Länge 1 [mm]: 20

Länge 2 [mm]: 91,8

OPEL, SUZUKI, VAUXHALL**24.4122-1720.3****011065****Hauptbremszylinder**

Durchmesser [mm]: 22,2

Gewindemaß: M12x1

Anschlussanzahl: 2

Material: Aluguss

MAPP-Code vorhanden:

Bremsystem: ATE

Ergänzungsartikel/Ergänzende Info 2: ohne Bremsflüssigkeitsbehälter

Länge 1 [mm]: 20

Länge 2 [mm]: 91,8

RENAULT**24.4122-1721.3****011079****Hauptbremszylinder**

Durchmesser [mm]: 22,2

Gewindemaß: M10x1

Anschlussanzahl: 2

Material: Aluguss

MAPP-Code vorhanden:

Bremsystem: ATE

Ergänzungsartikel/Ergänzende Info 2: ohne Bremsflüssigkeitsbehälter

Länge 1 [mm]: 21

Länge 2 [mm]: 86,8

FIAT**24.4122-1722.3****011085****Hauptbremszylinder**

Durchmesser [mm]: 22,2

Gewindemaß: M12x1

Anschlussanzahl: 2

Material: Aluguss

MAPP-Code vorhanden:

Ergänzungsartikel/Ergänzende Info 2: ohne Bremsflüssigkeitsbehälter

Länge 1 [mm]: 27

Länge 2 [mm]: 92

BMW, MINI

24.4122-1723.3**011086****Hauptbremszylinder**

Durchmesser [mm]: 22,2

Gewindemaß: M12x1

Anschlussanzahl: 2

Material: Aluguss

MAPP-Code vorhanden:

Ergänzungsartikel/Ergänzende Info 2: ohne Bremsflüssigkeitsbehälter

Länge 1 [mm]: 29

Länge 2 [mm]: 102

HYUNDAI, KIA**24.4122-1724.3****011080****Hauptbremszylinder**

Durchmesser [mm]: 22,2

Gewindemaß: M10x1

Anschlussanzahl: 2

Material: Aluguss

MAPP-Code vorhanden:

Bremsssystem: ATE

Ergänzungsartikel/Ergänzende Info 2: ohne Bremsflüssigkeitsbehälter

Länge 1 [mm]: 29

Länge 2 [mm]: 102

HYUNDAI, KIA**24.4122-1725.3****011087****Hauptbremszylinder**

Durchmesser [mm]: 22,2

Gewindemaß: M12x1

Anschlussanzahl: 2

Material: Aluguss

MAPP-Code vorhanden:

Ergänzungsartikel/Ergänzende Info 2: ohne Bremsflüssigkeitsbehälter

Länge 1 [mm]: 29

Länge 2 [mm]: 102

HYUNDAI**24.4122-1726.3****011096****Hauptbremszylinder**

Durchmesser [mm]: 22,2

Gewindemaß: M12x1

Anschlussanzahl: 2

Material: Aluguss

MAPP-Code vorhanden:

Ergänzungsartikel/Ergänzende Info 2: ohne Bremsflüssigkeitsbehälter

Länge 1 [mm]: 20

Länge 2 [mm]: 99

CITROËN, PEUGEOT

24.4122-1727.3**011098****Hauptbremszylinder**

Durchmesser [mm]: 22,2

Gewindemaß: M10x1

Anschlussanzahl: 2

Material: Aluguss

MAPP-Code vorhanden:

Ergänzungsartikel/Ergänzende Info 2: ohne Bremsflüssigkeitsbehälter

Länge 1 [mm]: 32

Länge 2 [mm]: 84

FIAT**24.4122-1728.3****011103****Hauptbremszylinder**

Durchmesser [mm]: 22,2

Gewindemaß: M10x1

Anschlussanzahl: 2

Material: Aluguss

MAPP-Code vorhanden:

Ergänzungsartikel/Ergänzende Info 2: ohne Bremsflüssigkeitsbehälter

Länge 1 [mm]: 25

Länge 2 [mm]: 104,9

TOYOTA**24.4122-1729.3****011104****Hauptbremszylinder**

Durchmesser [mm]: 22,2

Gewindemaß: M12x1

Anschlussanzahl: 2

Material: Aluguss

MAPP-Code vorhanden:

Ergänzungsartikel/Ergänzende Info 2: ohne Bremsflüssigkeitsbehälter

Länge 1 [mm]: 25

Länge 2 [mm]: 104,9

MAZDA**24.4122-1730.3****011105****Hauptbremszylinder**

Durchmesser [mm]: 22,2

Gewindemaß: M10x1

Anschlussanzahl: 2

Material: Aluguss

MAPP-Code vorhanden:

Ergänzungsartikel/Ergänzende Info 2: ohne Bremsflüssigkeitsbehälter

Länge 1 [mm]: 25

Länge 2 [mm]: 104,9

LEXUS, TOYOTA

24.4122-1731.3**011100****Hauptbremszylinder**

Durchmesser [mm]: 22,2

Gewindemaß: M12x1

Anschlussanzahl: 2

Material: Aluguss

MAPP-Code vorhanden:

Ergänzungsartikel/Ergänzende Info 2: ohne Bremsflüssigkeitsbehälter

Länge 1 [mm]: 32

Länge 2 [mm]: 80,5

OPEL, VAUXHALL**24.4122-1732.3****011107****Hauptbremszylinder**

Durchmesser [mm]: 22,2

Gewindemaß: M12x1

Anschlussanzahl: 2

Material: Aluguss

MAPP-Code vorhanden:

Ergänzungsartikel/Ergänzende Info 2: ohne Bremsflüssigkeitsbehälter

Länge 1 [mm]: 29

Länge 2 [mm]: 102

HYUNDAI, KIA**24.4122-1733.3****011116****Hauptbremszylinder**

Durchmesser [mm]: 22,2

Gewindemaß: M12x1

Anschlussanzahl: 2

Material: Aluguss

MAPP-Code vorhanden:

Ergänzungsartikel/Ergänzende Info 2: ohne Bremsflüssigkeitsbehälter

Länge 1 [mm]: 32

Länge 2 [mm]: 87,4

FORD**24.4122-1734.3****011117****Hauptbremszylinder**

Durchmesser [mm]: 22,2

Gewindemaß: M10x1

Anschlussanzahl: 2

Material: Aluguss

MAPP-Code vorhanden:

Ergänzungsartikel/Ergänzende Info 2: ohne Bremsflüssigkeitsbehälter

Länge 1 [mm]: 32

Länge 2 [mm]: 87,4

FIAT

24.4122-1735.3**011113****Hauptbremszylinder**

Durchmesser [mm]: 22,2

Gewindemaß: M12x1

Anschlussanzahl: 2

Material: Aluguss

MAPP-Code vorhanden:

Ergänzungsartikel/Ergänzende Info 2: ohne Bremsflüssigkeitsbehälter

Länge 1 [mm]: 22

Länge 2 [mm]: 86,6

CHEVROLET**24.4122-1736.3****011129****Hauptbremszylinder**

Durchmesser [mm]: 22,2

Gewindemaß: M10x1

Anschlussanzahl: 2

Material: Aluguss

MAPP-Code vorhanden:

Ergänzungsartikel/Ergänzende Info 2: ohne Bremsflüssigkeitsbehälter

Länge 1 [mm]: 29

Länge 2 [mm]: 101,9

HYUNDAI**24.4122-1737.3****011147****Hauptbremszylinder**

Durchmesser [mm]: 22,2

Gewindemaß: M12x1

Anschlussanzahl: 2

Material: Aluguss

MAPP-Code vorhanden:

Bremsssystem: BOS

Ergänzungsartikel/Ergänzende Info 2: ohne Bremsflüssigkeitsbehälter

Länge 1 [mm]: 32

Länge 2 [mm]: 78

OPEL, VAUXHALL**24.4122-1738.3****011148****Hauptbremszylinder**

Durchmesser [mm]: 22,2

Gewindemaß: M10x1

Anschlussanzahl: 2

Material: Aluguss

MAPP-Code vorhanden:

Bremsssystem: BOS

Ergänzungsartikel/Ergänzende Info 2: ohne Bremsflüssigkeitsbehälter

Länge 1 [mm]: 32,5

Länge 2 [mm]: 84

OPEL, VAUXHALL

24.4122-1739.3**011149****Hauptbremszylinder**

Durchmesser [mm]: 22,2

Gewindemaß: M12x1

Anschlussanzahl: 2

Material: Aluguss

MAPP-Code vorhanden:

Bremsystem: BOS

Ergänzungsartikel/Ergänzende Info 2: ohne Bremsflüssigkeitsbehälter

Länge 1 [mm]: 32

Länge 2 [mm]: 78

FIAT**24.4123-1703.3****010831****Hauptbremszylinder**

Durchmesser [mm]: 23,8

Gewindemaß: M12x1

Anschlussanzahl: 2

MAPP-Code vorhanden:

Bremsystem: TRW

Länge 1 [mm]: 55

Länge 2 [mm]: 53

MERCEDES-BENZ**24.4123-1704.3****010828****Hauptbremszylinder**

Durchmesser [mm]: 23,8

Gewindemaß: M12x1

Anschlussanzahl: 2

MAPP-Code vorhanden:

Bremsystem: TRW

Länge 1 [mm]: 6

Länge 2 [mm]: 112

CITROËN, OPEL, PEUGEOT, VAUXHALL**24.4123-1705.3****010832****Hauptbremszylinder**

Durchmesser [mm]: 23,8

Gewindemaß: M10x1

Anschlussanzahl: 2

MAPP-Code vorhanden:

Bremsystem: TRW

Länge 1 [mm]: 6

Länge 2 [mm]: 112

CITROËN, PEUGEOT

24.4123-1708.3**010859****Hauptbremszylinder**

Durchmesser [mm]: 23,8

Gewindemaß: M10x1

Anschlussanzahl: 2

MAPP-Code vorhanden:

Bremsystem: BOS

Länge 1 [mm]: 32

Länge 2 [mm]: 83,5

FIAT, LANCIA**24.4123-1710.3****010866****Hauptbremszylinder**

Durchmesser [mm]: 23,8

Gewindemaß: M10x1

Anschlussanzahl: 2

MAPP-Code vorhanden:

Bremsystem: BOS

Ergänzungsartikel/Ergänzende Info 2: ohne Bremsflüssigkeitsbehälter

Länge 1 [mm]: 32

Länge 2 [mm]: 86,2

CHRYSLER, FIAT, LANCIA**24.4123-1712.3****010897****Hauptbremszylinder**

Durchmesser [mm]: 23,8

Gewindemaß: M12x1

Anschlussanzahl: 2

MAPP-Code vorhanden:

Bremsystem: TRW

Länge 1 [mm]: 14

Länge 2 [mm]: 95

MINI**24.4123-1713.3****010905****Hauptbremszylinder**

Durchmesser [mm]: 23,8

Anschlussanzahl: 4

MAPP-Code vorhanden:

Bremsystem: BOS

Gewindemaß 1: 2x M10x1

Gewindemaß 2: 2x M12x1

Ergänzungsartikel/Ergänzende Info 2: ohne Bremsflüssigkeitsbehälter

Länge 1 [mm]: 31,7

Länge 2 [mm]: 93,5

FORD

24.4123-1714.3**010979****Hauptbremszylinder**

Durchmesser [mm]: 23,8

Gewindemaß: M12x1

Anschlussanzahl: 2

MAPP-Code vorhanden:

Bremsystem: TRW

Länge 1 [mm]: 18

Länge 2 [mm]: 100

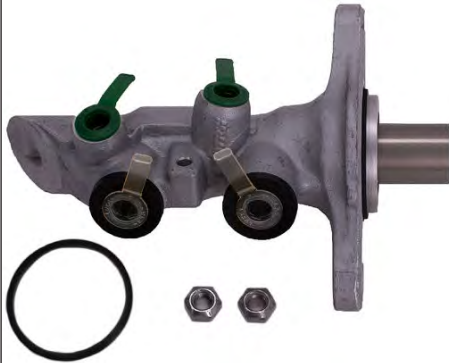
CITROËN, PEUGEOT**24.4123-1715.3****010980****Hauptbremszylinder**

Durchmesser [mm]: 23,8

Gewindemaß: M12x1

Anschlussanzahl: 2

MAPP-Code vorhanden:

Bremsystem: TRW

Länge 1 [mm]: 5,7

Länge 2 [mm]: 147

RENAULT**24.4123-1717.3****010985****Hauptbremszylinder**

Durchmesser [mm]: 23,8

Gewindemaß: M12x1

Anschlussanzahl: 2

MAPP-Code vorhanden:

Bremsystem: TRW

Ergänzungsartikel/Ergänzende Info 2: ohne Bremsflüssigkeitsbehälter

Länge 1 [mm]: 5,8

Länge 2 [mm]: 111,2

OPEL, VAUXHALL**24.4123-1718.3****011016****Hauptbremszylinder**

Durchmesser [mm]: 23,8

Gewindemaß: M12x1

Anschlussanzahl: 2

MAPP-Code vorhanden:

Bremsystem: TRW

Ergänzungsartikel/Ergänzende Info 2: ohne Bremsflüssigkeitsbehälter

Länge 1 [mm]: 30,3

Länge 2 [mm]: 102,5

MERCEDES-BENZ

24.4123-1719.3**011017****Hauptbremszylinder**

Durchmesser [mm]: 23,8

Gewindemaß: M12x1

Anschlussanzahl: 2

MAPP-Code vorhanden:

Bremsystem: TRW

Ergänzungsartikel/Ergänzende Info 2: ohne Bremsflüssigkeitsbehälter

Länge 1 [mm]: 5

Länge 2 [mm]: 126

AUDI, CUPRA, SEAT, SKODA, VW**24.4123-1720.3****011022****Hauptbremszylinder**

Durchmesser [mm]: 23,8

Gewindemaß: M10x1

Anschlussanzahl: 2

MAPP-Code vorhanden:

Bremsystem: BOS

Ergänzungsartikel/Ergänzende Info 2: ohne Bremsflüssigkeitsbehälter

Länge 1 [mm]: 32

Länge 2 [mm]: 79,9

ABARTH, ALFA ROMEO, OPEL, VAUXHALL**24.4123-1721.3****011052****Hauptbremszylinder**

Durchmesser [mm]: 23,8

Gewindemaß: M12x1

Anschlussanzahl: 2

Material: Aluguss

MAPP-Code vorhanden:

Bremsystem: BOS

Ergänzungsartikel/Ergänzende Info 2: ohne Bremsflüssigkeitsbehälter

Länge 1 [mm]: 32

Länge 2 [mm]: 82

RENAULT**24.4123-1722.3****011071****Hauptbremszylinder**

Durchmesser [mm]: 23,8

Gewindemaß: M12x1

Anschlussanzahl: 2

Material: Aluguss

MAPP-Code vorhanden:

Ergänzungsartikel/Ergänzende Info 2: ohne Bremsflüssigkeitsbehälter

Länge 1 [mm]: 32

Länge 2 [mm]: 79,9

OPEL, VAUXHALL

24.4123-1723.3**011074****Hauptbremszylinder**

Durchmesser [mm]: 23,8

Gewindemaß: M12x1

Anschlussanzahl: 2

Material: Aluguss

MAPP-Code vorhanden:

Ergänzungsartikel/Ergänzende Info 2: ohne Bremsflüssigkeitsbehälter

Länge 1 [mm]: 34

Länge 2 [mm]: 116

RENAULT**24.4123-1724.3****011075****Hauptbremszylinder**

Durchmesser [mm]: 23,8

Gewindemaß: M12x1

Anschlussanzahl: 2

Material: Aluguss

MAPP-Code vorhanden:

Bremsssystem: TRW

Ergänzungsartikel/Ergänzende Info 2: ohne Bremsflüssigkeitsbehälter

Länge 1 [mm]: 5,5

Länge 2 [mm]: 107

RENAULT**24.4123-1725.3****011073****Hauptbremszylinder**

Durchmesser [mm]: 23,8

Gewindemaß: M12x1

Anschlussanzahl: 2

Material: Aluguss

MAPP-Code vorhanden:

Ergänzungsartikel/Ergänzende Info 2: ohne Bremsflüssigkeitsbehälter

Länge 1 [mm]: 32

Länge 2 [mm]: 84

NISSAN**24.4123-1726.3****011099****Hauptbremszylinder**

Durchmesser [mm]: 23,8

Gewindemaß: M12x1

Anschlussanzahl: 2

Material: Aluguss

MAPP-Code vorhanden:

Ergänzungsartikel/Ergänzende Info 2: ohne Bremsflüssigkeitsbehälter

Länge 1 [mm]: 32

Länge 2 [mm]: 84

CITROËN, DS

24.4123-1727.3**011088****Hauptbremszylinder**

Durchmesser [mm]: 23,8

Gewindemaß: M12x1

Anschlussanzahl: 2

Material: Aluguss

MAPP-Code vorhanden:

Ergänzungsartikel/Ergänzende Info 2: ohne Bremsflüssigkeitsbehälter

Länge 1 [mm]: 13,5

Länge 2 [mm]: 97,4

NISSAN**24.4123-1728.3****011089****Hauptbremszylinder**

Durchmesser [mm]: 23,8

Gewindemaß: M12x1

Anschlussanzahl: 2

Material: Aluguss

MAPP-Code vorhanden:

Ergänzungsartikel/Ergänzende Info 2: ohne Bremsflüssigkeitsbehälter

Länge 1 [mm]: 20

Länge 2 [mm]: 91

NISSAN, RENAULT**24.4123-1729.3****011106****Hauptbremszylinder**

Durchmesser [mm]: 23,8

Gewindemaß: M10x1

Anschlussanzahl: 2

Material: Aluguss

MAPP-Code vorhanden:

Ergänzungsartikel/Ergänzende Info 2: ohne Bremsflüssigkeitsbehälter

Länge 1 [mm]: 32

Länge 2 [mm]: 84

NISSAN**24.4123-1730.3****011097****Hauptbremszylinder**

Durchmesser [mm]: 23,8

Gewindemaß: M12x1

Anschlussanzahl: 2

Material: Aluguss

MAPP-Code vorhanden:

Ergänzungsartikel/Ergänzende Info 2: ohne Bremsflüssigkeitsbehälter

Länge 1 [mm]: 32

CITROËN, PEUGEOT

24.4123-1731.3**011094****Hauptbremszylinder**

Durchmesser [mm]: 23,8

Gewindemaß: M12x1

Anschlussanzahl: 2

Material: Aluguss

MAPP-Code vorhanden:

Ergänzungsartikel/Ergänzende Info 2: ohne Bremsflüssigkeitsbehälter

Länge 1 [mm]: 32

FIAT, JEEP**24.4123-1732.3****011101****Hauptbremszylinder**

Durchmesser [mm]: 23,8

Gewindemaß: M12x1

Anschlussanzahl: 2

Material: Aluguss

MAPP-Code vorhanden:

Ergänzungsartikel/Ergänzende Info 2: ohne Bremsflüssigkeitsbehälter

Länge 1 [mm]: 31,8

TOYOTA**24.4123-1733.3****011108****Hauptbremszylinder**

Durchmesser [mm]: 23,8

Gewindemaß: M12x1

Anschlussanzahl: 2

Material: Aluguss

MAPP-Code vorhanden:

Ergänzungsartikel/Ergänzende Info 2: ohne Bremsflüssigkeitsbehälter

Länge 1 [mm]: 27

Länge 2 [mm]: 92

BMW, MINI**24.4123-1734.3****011130****Hauptbremszylinder**

Durchmesser [mm]: 23,8

Gewindemaß: M12x1

Anschlussanzahl: 2

Material: Aluguss

MAPP-Code vorhanden:

Ergänzungsartikel/Ergänzende Info 2: ohne Bremsflüssigkeitsbehälter

Länge 1 [mm]: 19,5

Länge 2 [mm]: 99

CITROËN, DS, PEUGEOT

24.4123-1735.3**011131****Hauptbremszylinder**

Durchmesser [mm]: 23,8

Gewindemaß: M10x1

Anschlussanzahl: 2

Material: Aluguss

MAPP-Code vorhanden:

Ergänzungsartikel/Ergänzende Info 2: ohne Bremsflüssigkeitsbehälter

Länge 1 [mm]: 20

Länge 2 [mm]: 99

CITROËN**24.4123-1736.3****011118****Hauptbremszylinder**

Durchmesser [mm]: 23,8

Gewindemaß: M12x1

Anschlussanzahl: 2

Material: Aluguss

MAPP-Code vorhanden:

Ergänzungsartikel/Ergänzende Info 2: ohne Bremsflüssigkeitsbehälter

Länge 1 [mm]: 19

Länge 2 [mm]: 90

BMW**24.4123-1737.3****011119****Hauptbremszylinder**

Durchmesser [mm]: 23,8

Gewindemaß: M12x1

Anschlussanzahl: 2

Material: Aluguss

MAPP-Code vorhanden:

Ergänzungsartikel/Ergänzende Info 2: ohne Bremsflüssigkeitsbehälter

Länge 1 [mm]: 29

Länge 2 [mm]: 102

HYUNDAI**24.4123-1738.3****011124****Hauptbremszylinder**

Durchmesser [mm]: 23,8

Gewindemaß: M12x1

Anschlussanzahl: 2

Material: Aluguss

MAPP-Code vorhanden:

Ergänzungsartikel/Ergänzende Info 2: ohne Bremsflüssigkeitsbehälter

Länge 1 [mm]: 22

Länge 2 [mm]: 86,6

CHEVROLET, OPEL, VAUXHALL

24.4123-1739.3**011150****Hauptbremszylinder**

Durchmesser [mm]: 23,8

Anschlussanzahl: 2

Material: Aluguss

MAPP-Code vorhanden:

Bremsystem: BOS

Gewindemaß 1: M10x1

Gewindemaß 2: M12x1

Ergänzungsartikel/Ergänzende Info 2: ohne Bremsflüssigkeitsbehälter

Länge 1 [mm]: 32

Länge 2 [mm]: 84

CITROËN, DS**24.4123-1741.3****011151****Hauptbremszylinder**

Durchmesser [mm]: 23,8

Gewindemaß: M12x1

Anschlussanzahl: 2

Material: Aluguss

MAPP-Code vorhanden:

Bremsystem: BOS

Ergänzungsartikel/Ergänzende Info 2: ohne Bremsflüssigkeitsbehälter

Länge 1 [mm]: 32

Länge 2 [mm]: 87,3

CITROËN, PEUGEOT**24.4123-1742.3****011156****Hauptbremszylinder**

Durchmesser [mm]: 23,8

Anschlussanzahl: 2

Material: Aluguss

MAPP-Code vorhanden:

Bremsystem: TRW

Gewindemaß 1: M10x1

Gewindemaß 2: M12x1

Ergänzungsartikel/Ergänzende Info 2: ohne Bremsflüssigkeitsbehälter

Länge 1 [mm]: 18

Länge 2 [mm]: 100

CITROËN, PEUGEOT

24.4125-1701.3**010867****Hauptbremszylinder**

Durchmesser [mm]: 25,4

Gewindemaß: M12x1

Anschlussanzahl: 2

MAPP-Code vorhanden:

Bremsystem: BOS

Ergänzungsartikel/Ergänzende Info 2: ohne Bremsflüssigkeitsbehälter

Länge 1 [mm]: 10,5

Länge 2 [mm]: 126,5

CITROËN, FIAT, PEUGEOT**24.4125-1702.3****010872****Hauptbremszylinder**

Durchmesser [mm]: 25,4

Gewindemaß: M10x1

Anschlussanzahl: 2

MAPP-Code vorhanden:

Bremsystem: BOS

Ergänzungsartikel/Ergänzende Info 2: ohne Bremsflüssigkeitsbehälter

Länge 1 [mm]: 10,5

Länge 2 [mm]: 126,5

CITROËN, FIAT, PEUGEOT**24.4125-1703.3****010907****Hauptbremszylinder**

Durchmesser [mm]: 25,4

Gewindemaß: M12x1

Anschlussanzahl: 2

MAPP-Code vorhanden:

Bremsystem: TRW

Länge 1 [mm]: 18

Länge 2 [mm]: 90,5

OPEL, VAUXHALL**24.4125-1704.3****010908****Hauptbremszylinder**

Durchmesser [mm]: 25,4

Anschlussanzahl: 2

MAPP-Code vorhanden:

Bremsystem: TRW

Gewindemaß 1: M10x1

Gewindemaß 2: M12x1

Länge 1 [mm]: 18

Länge 2 [mm]: 90,5

OPEL, VAUXHALL

24.4125-1708.3**011055****Hauptbremszylinder**

Durchmesser [mm]: 25,4

Gewindemaß: M12x1

Anschlussanzahl: 2

Material: Aluguss

MAPP-Code vorhanden:

Ergänzungsartikel/Ergänzende Info 2: ohne Bremsflüssigkeitsbehälter

Länge 1 [mm]: 32,7

Länge 2 [mm]: 86,5

FORD**24.4125-1709.3****011077****Hauptbremszylinder**

Durchmesser [mm]: 25,4

Gewindemaß: M12x1

Anschlussanzahl: 2

Material: Aluguss

MAPP-Code vorhanden:

Bremsssystem: TRW

Ergänzungsartikel/Ergänzende Info 2: ohne Bremsflüssigkeitsbehälter

Länge 1 [mm]: 17,5

Länge 2 [mm]: 92

BMW**24.4125-1710.3****011091****Hauptbremszylinder**

Durchmesser [mm]: 25,4

Anschlussanzahl: 2

Material: Aluguss

Gewindemaß 1: M10x1

Gewindemaß 2: M12x1

Ergänzungsartikel/Ergänzende Info 2: ohne Bremsflüssigkeitsbehälter

Länge 1 [mm]: 23,2

Länge 2 [mm]: 86,5

FORD**24.4125-1711.3****011111****Hauptbremszylinder**

Durchmesser [mm]: 25,4

Gewindemaß: M12x1

Anschlussanzahl: 2

Material: Aluguss

Ergänzungsartikel/Ergänzende Info 2: ohne Bremsflüssigkeitsbehälter

Länge 1 [mm]: 10,5

Länge 2 [mm]: 125,5

FIAT

24.4125-1712.3**011112****Hauptbremszylinder**

Durchmesser [mm]: 25,4

Gewindemaß: M10x1

Anschlussanzahl: 2

Material: Aluguss

Ergänzungsartikel/Ergänzende Info 2: ohne Bremsflüssigkeitsbehälter

Länge 1 [mm]: 10

Länge 2 [mm]: 125,5

FIAT**24.4125-1713.3****011109****Hauptbremszylinder**

Durchmesser [mm]: 25,4

Gewindemaß: M12x1

Anschlussanzahl: 2

Material: Aluguss

Ergänzungsartikel/Ergänzende Info 2: ohne Bremsflüssigkeitsbehälter

Länge 1 [mm]: 19

Länge 2 [mm]: 90

BMW**24.4125-1715.3****011152****Hauptbremszylinder**

Durchmesser [mm]: 25,4

Gewindemaß: M10x1

Anschlussanzahl: 2

Material: Aluguss

MAPP-Code vorhanden:

Bremsssystem: BOS

Ergänzungsartikel/Ergänzende Info 2: ohne Bremsflüssigkeitsbehälter

Länge 1 [mm]: 10,5

Länge 2 [mm]: 124

FIAT**24.4125-1717.3****011157****Hauptbremszylinder**

Durchmesser [mm]: 25,4

Gewindemaß: M10x1

Anschlussanzahl: 2

Material: Aluguss

MAPP-Code vorhanden:

Bremsssystem: BOS

Ergänzungsartikel/Ergänzende Info 2: ohne Bremsflüssigkeitsbehälter

Länge 1 [mm]: 10,5

Länge 2 [mm]: 124

CITROËN, OPEL, PEUGEOT, VAUXHALL

24.4125-1718.3**011158****Hauptbremszylinder**

Durchmesser [mm]: 25,4

Gewindemaß: M12x1

Anschlussanzahl: 2

Material: Aluguss

MAPP-Code vorhanden:

Bremsystem: BOS

Ergänzungsartikel/Ergänzende Info 2: ohne Bremsflüssigkeitsbehälter

Länge 1 [mm]: 10,5

Länge 2 [mm]: 125

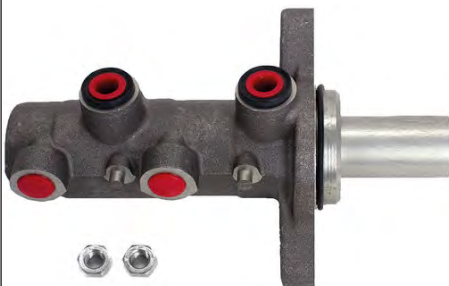
CITROËN, OPEL, PEUGEOT, VAUXHALL**24.4126-1701.3****010868****Hauptbremszylinder**

Durchmesser [mm]: 27

Gewindemaß: M12x1

Anschlussanzahl: 2

MAPP-Code vorhanden:

Bremsystem: BOS

Ergänzungsartikel/Ergänzende Info 2: ohne Bremsflüssigkeitsbehälter

Länge 1 [mm]: 10,5

Länge 2 [mm]: 126,5

CITROËN, FIAT, PEUGEOT**24.4126-1702.3****010875****Hauptbremszylinder**

Durchmesser [mm]: 27

Gewindemaß: M10x1

Anschlussanzahl: 2

MAPP-Code vorhanden:

Bremsystem: BOS

Ergänzungsartikel/Ergänzende Info 2: ohne Bremsflüssigkeitsbehälter

Länge 1 [mm]: 10,5

Länge 2 [mm]: 126,5

CITROËN, FIAT, PEUGEOT**24.4126-1704.3****011159****Hauptbremszylinder**

Durchmesser [mm]: 27

Gewindemaß: M10x1

Anschlussanzahl: 2

Material: Aluguss

MAPP-Code vorhanden:

Ergänzungsartikel/Ergänzende Info 2: ohne Bremsflüssigkeitsbehälter

Länge 1 [mm]: 10,5

Länge 2 [mm]: 129

CITROËN, PEUGEOT

24.4126-1705.3**011160****Hauptbremszylinder**

Durchmesser [mm]: 27

Gewindemaß: M10x1

Anschlussanzahl: 2

Material: Aluguss

MAPP-Code vorhanden:

Ergänzungsartikel/Ergänzende Info 2: ohne Bremsflüssigkeitsbehälter

Länge 1 [mm]: 10,5

Länge 2 [mm]: 129

CITROËN, OPEL, PEUGEOT, VAUXHALL**24.4128-1700.3****011161****Hauptbremszylinder**

Durchmesser [mm]: 28,6

Gewindemaß: M14x1,5

Anschlussanzahl: 2

Material: Aluguss

MAPP-Code vorhanden:

Bremsssystem: BOS

Ergänzungsartikel/Ergänzende Info 2: ohne Bremsflüssigkeitsbehälter

Länge 1 [mm]: 10,5

Länge 2 [mm]: 140

FORD**24.4150-1071.3****011046****Hauptbremszylinder**

Durchmesser [mm]: 20,6

Gewindemaß: M12x1

Anschlussanzahl: 2

Material: Aluguss

MAPP-Code vorhanden:

Bremsssystem: ATE

Ergänzungsartikel/Ergänzende Info 2: ohne Bremsflüssigkeitsbehälter

Länge 1 [mm]: 25,8

Länge 2 [mm]: 86,1

RENAULT, SMART**24.4152-0132.3****011025****Hauptbremszylinder**

Durchmesser [mm]: 22,2

Gewindemaß: M12x1

Anschlussanzahl: 2

MAPP-Code vorhanden:

Bremsssystem: ATE

Ergänzungsartikel/Ergänzende Info 2: ohne Bremsflüssigkeitsbehälter

Länge 1 [mm]: 116,8

Länge 2 [mm]: 38,1

SEAT, SKODA, VW

24.4152-0381.3**011032****Hauptbremszylinder**

Durchmesser [mm]: 22,2

Gewindemaß: M10x1

Anschlussanzahl: 2

MAPP-Code vorhanden:

Bremsystem: ATE

Ergänzungsartikel/Ergänzende Info 2: ohne Bremsflüssigkeitsbehälter

Länge 1 [mm]: 108,3

Länge 2 [mm]: 6,6

DACIA, RENAULT**24.4152-0391.3****011033****Hauptbremszylinder**

Durchmesser [mm]: 22,2

Gewindemaß: M12x1

Anschlussanzahl: 2

MAPP-Code vorhanden:

Bremsystem: ATE

Ergänzungsartikel/Ergänzende Info 2: ohne Bremsflüssigkeitsbehälter

Länge 1 [mm]: 108,3

Länge 2 [mm]: 6,6

DACIA, RENAULT**24.4153-0192.3****011026****Hauptbremszylinder**

Durchmesser [mm]: 23,8

Gewindemaß: M12x1

Anschlussanzahl: 2

MAPP-Code vorhanden:

Bremsystem: ATE

Ergänzungsartikel/Ergänzende Info 2: ohne Bremsflüssigkeitsbehälter

Länge 1 [mm]: 116,8

Länge 2 [mm]: 38,1

AUDI, VW**24.4153-0202.3****011027****Hauptbremszylinder**

Durchmesser [mm]: 23,8

Gewindemaß: M12x1

Anschlussanzahl: 2

MAPP-Code vorhanden:

Bremsystem: ATE

Ergänzungsartikel/Ergänzende Info 2: ohne Bremsflüssigkeitsbehälter

Länge 1 [mm]: 38,1

Länge 2 [mm]: 105,7

SEAT, SKODA, VW

24.4153-0217.3**011039****Hauptbremszylinder**

Durchmesser [mm]: 23,8

Gewindemaß: M12x1

Anschlussanzahl: 2

MAPP-Code vorhanden:

Bremsystem: ATE

Ergänzungsartikel/Ergänzende Info 2: ohne Bremsflüssigkeitsbehälter

Länge 1 [mm]: 38,1

Länge 2 [mm]: 116,8

AUDI**24.4153-0222.3****011047****Hauptbremszylinder**

Durchmesser [mm]: 23,8

Gewindemaß: M12x1

Anschlussanzahl: 2

Material: Aluguss

MAPP-Code vorhanden:

Bremsystem: ATE

Ergänzungsartikel/Ergänzende Info 2: ohne Bremsflüssigkeitsbehälter

Länge 1 [mm]: 38,1

Länge 2 [mm]: 116,8

SEAT, VW**24.4153-1522.3****011048****Hauptbremszylinder**

Durchmesser [mm]: 23,8

Gewindemaß: M12x1

Anschlussanzahl: 2

Material: Aluguss

MAPP-Code vorhanden:

Bremsystem: ATE

Ergänzungsartikel/Ergänzende Info 2: ohne Bremsflüssigkeitsbehälter

Länge 1 [mm]: 18

Länge 2 [mm]: 123,3

AUDI, CUPRA, SEAT, SKODA, VW**24.4155-0201.3****011125****Hauptbremszylinder**

Durchmesser [mm]: 25,4

Gewindemaß: M12x1

Anschlussanzahl: 2

MAPP-Code vorhanden:

Bremsystem: ATE

Ergänzungsartikel/Ergänzende Info 2: ohne Bremsflüssigkeitsbehälter

Länge 1 [mm]: 25,7

Länge 2 [mm]: 89,2

CHEVROLET, OPEL, SAAB, VAUXHALL

24.4155-1236.3**011049****Hauptbremszylinder**

Durchmesser [mm]: 25,4

Gewindemaß: M12x1

Anschlussanzahl: 2

Material: Aluguss

MAPP-Code vorhanden:

Bremsystem: ATE

Ergänzungsartikel/Ergänzende Info 2: ohne Bremsflüssigkeitsbehälter

Länge 1 [mm]: 31,7

Länge 2 [mm]: 92

CITROËN, DS**24.4155-1311.3****011053****Hauptbremszylinder**

Durchmesser [mm]: 25,4

Gewindemaß: M12x1

Anschlussanzahl: 2

Material: Aluguss

MAPP-Code vorhanden:

Bremsystem: ATE

Ergänzungsartikel/Ergänzende Info 2: ohne Bremsflüssigkeitsbehälter

Länge 1 [mm]: 30,1

Länge 2 [mm]: 93,8

CITROËN, PEUGEOT**24.4156-1016.3****011068****Hauptbremszylinder**

Durchmesser [mm]: 27

Gewindemaß: M12x1

Anschlussanzahl: 2

MAPP-Code vorhanden:

Bremsystem: ATE

Länge 1 [mm]: 19,5

Länge 2 [mm]: 90

JAGUAR**24.4156-1051.3****011069****Hauptbremszylinder**

Durchmesser [mm]: 27

Gewindemaß: M12x1

Anschlussanzahl: 2

MAPP-Code vorhanden:

Bremsystem: ATE

Ergänzungsartikel/Ergänzende Info 2: ohne Bremsflüssigkeitsbehälter

Länge 1 [mm]: 19,8

Länge 2 [mm]: 90

JAGUAR

24.4156-1076.3**011070****Hauptbremszylinder**

Durchmesser [mm]: 27

Gewindemaß: M12x1

Anschlussanzahl: 2

MAPP-Code vorhanden:

Bremsystem: ATE

Ergänzungsartikel/Ergänzende Info 2: ohne Bremsflüssigkeitsbehälter

Länge 1 [mm]: 19,5

Länge 2 [mm]: 90

JAGUAR**24.4156-1136.3****011126****Hauptbremszylinder**

Durchmesser [mm]: 27

Gewindemaß: M12x1

Anschlussanzahl: 2

MAPP-Code vorhanden:

Bremsystem: ATE

Ergänzungsartikel/Ergänzende Info 2: ohne Bremsflüssigkeitsbehälter

Länge 1 [mm]: 28,7

Länge 2 [mm]: 80,2

MERCEDES-BENZ**24.4156-1221.3****011127****Hauptbremszylinder**

Durchmesser [mm]: 27

Gewindemaß: M12x1

Anschlussanzahl: 2

MAPP-Code vorhanden:

Bremsystem: ATE

Ergänzungsartikel/Ergänzende Info 2: ohne Bremsflüssigkeitsbehälter

Länge 1 [mm]: 30,7

Länge 2 [mm]: 84,2

MERCEDES-BENZ**24.4156-1270.3****011058****Hauptbremszylinder**

Durchmesser [mm]: 27

Gewindemaß: M14x1

Anschlussanzahl: 2

Material: Aluguss

MAPP-Code vorhanden:

Bremsystem: ATE

Ergänzungsartikel/Ergänzende Info 2: ohne Bremsflüssigkeitsbehälter

Länge 1 [mm]: 13,4

Länge 2 [mm]: 101,5

LAND ROVER

24.4156-1391.3

011054



Hauptbremszylinder

Durchmesser [mm]: 27

Gewindemaß: M12x1

Anschlussanzahl: 2

Material: Aluguss

MAPP-Code vorhanden:

Bremssystem: ATE

Ergänzungsartikel/Ergänzende Info 2: ohne Bremsflüssigkeitsbehälter

Länge 1 [mm]: 13,4

Länge 2 [mm]: 101,5

VOLVO

24.6046-0801.3

320116



Bremskraftregler

Kenngroße: 4/6

Anschlussanzahl: 2

FIAT

24.6512-1507.3

320023



Bremskraftregler

Anschlussanzahl: 3

lastabhängig:

CITROËN

24.6512-1701.3

320153



Bremskraftregler

Gewindemaß 1: M10x1

Gewindemaß 2: M12x1

Anschlussanzahl: 2

lastabhängig:

CITROËN, FIAT, PEUGEOT



24.6513-1705.3

320237



Bremskraftregler

Anschlussanzahl: 2

lastabhängig:

FIAT, LANCIA

24.9145-0003.2

399007



Hydraulikaggregat, Bremsanlage

für OE-Nummer: 34 51 6 863 354

Ergänzungsartikel/Ergänzende Info: ohne Steuergerät

Montageinformation beachten:

Bremssystem: hyd.

Brems-/Fahrndynamik: + ESP

BMW

24.9145-0004.2

399008



Hydraulikaggregat, Bremsanlage

Ergänzungsartikel/Ergänzende Info: ohne Steuergerät

Montageinformation beachten:

Bremssystem: hyd.

Brems-/Fahrndynamik: + ESP

FORD



DE Fahrzeugverwendungen

EN Applications of vehicles

















ES Aplicaciones















FR Applications

















IT Applicazioni autoveicoli











2025











	kw			 	! #		
ABARTH - 500 / 595 / 695 01/08→							
 Hauptbremszylinder							
1.4	99 - 140	08/08→				24.4122-1714.3 010914	TRW Ø 22,2 ohne Bremsflüssigkeitsbehälter
ABARTH - 500C / 595C / 695C 05/08→							
 Hauptbremszylinder							
1.4	99 - 132	05/08→				24.4122-1714.3 010914	TRW Ø 22,2 ohne Bremsflüssigkeitsbehälter
ABARTH - GRANDE PUNTO 07/07→06/10							
 Hauptbremszylinder							
1.4 1.4 ESSEESSE / SUPERSPORT	114 132	07/07→06/10 05/08→06/10				24.4123-1720.3 011022	BOS Ø 23,8 ohne Bremsflüssigkeitsbehälter
ABARTH - PUNTO 03/12→							
 Hauptbremszylinder							
1.4 1.4 SUPERSPORT	120 132	03/12→ 03/12→		für Linkslenker		24.4123-1720.3 011022	BOS Ø 23,8 ohne Bremsflüssigkeitsbehälter
ABARTH - PUNTO EVO 07/08→02/12							
 Hauptbremszylinder							
1.4	120	10/09→02/12		für Linkslenker		24.4123-1720.3 011022	BOS Ø 23,8 ohne Bremsflüssigkeitsbehälter
ALFA ROMEO - 145 (930_) 07/94→01/01							
 Hauptbremszylinder							
1.4 i.e. 16V T.S. 1.6 i.e. 16V T.S.	76 88	12/96→01/01 12/96→01/01		01/97→; GG		24.2122-1716.3 010485	Ø 22,2
1.6 16V T.S. 1.8 i.e. 16V 1.9 JTD 2.0 16V 2.0 16V T.S.	82 106 77 114 110	09/97→12/00 03/98→01/01 02/99→01/01 03/98→01/01 10/95→01/01		GG		24.2122-1716.3 010485	Ø 22,2
ALFA ROMEO - 146 (930_) 12/94→10/01							
 Hauptbremszylinder							
1.4 i.e. 16V T.S. 1.6 i.e. 16V T.S. 1.8 i.e. 16V T.S.	76 88 103	11/96→01/01 11/96→10/01 11/96→01/01		01/97→; GG		24.2122-1716.3 010485	Ø 22,2
1.6 16V T.S. 1.8 i.e. 16V T.S. 1.9 JTD 2.0 16V 2.0 16V T.S.	82 106 77 114 110	09/97→12/00 03/98→01/01 02/99→01/01 03/97→10/01 10/95→01/01		GG		24.2122-1716.3 010485	Ø 22,2
ALFA ROMEO - 159 (939_) 06/05→12/12							
 Hauptbremszylinder							
1.8 MPI 1.9 JTDM 16V 1.9 JTDM 8V 1.9 JTS 2.2 JTS 2.4 JTDM 2.4 JTDM Q4 3.2 JTS 3.2 JTS Q4	103 100 - 110 85 - 88 118 136 147 - 154 154 191 191	06/05→11/11 09/05→11/11 09/05→11/11 09/05→11/11 09/05→11/11 09/05→11/11 05/07→11/11 01/08→11/11 12/05→11/11		→ 06/08; für Fahrzeuge mit elektronischer Fahrdynamikregelung		24.2125-1732.3 010827	TRW Ø 25,4
ALFA ROMEO - 159 Sportwagon (939_) 06/05→12/12							
 Hauptbremszylinder							
1.8 MPI 1.9 JTDM 16V 1.9 JTDM 8V 1.9 JTS 2.2 JTS 2.4 JTDM 2.4 JTDM Q4 →	103 100 - 110 85 - 88 118 136 147 - 154 154	06/05→11/11 03/06→11/11 03/06→11/11 03/06→11/11 03/06→11/11 03/06→12/12 05/07→11/11		→ 06/08; für Fahrzeuge mit elektronischer Fahrdynamikregelung		24.2125-1732.3 010827	TRW Ø 25,4

	kw					! #		
ALFA ROMEO - 159 Sportwagon (939_) 06/05→12/12								
 Hauptbremszylinder								
3.2 JTS 3.2 JTS Q4	191 191	02/08→11/11 03/06→11/11			→ 06/08; für Fahrzeuge mit elektronischer Fahrdynamikregelung		24.2125-1732.3 010827	TRW Ø 25,4
ALFA ROMEO - 166 (936_) 09/98→06/07								
 Hauptbremszylinder								
2.0 T.Spark 2.0 V6 2.4 JTD 2.5 V6 24V 3.0 V6 24V	114 151 100 140 166	09/98→10/00 09/98→10/00 09/98→10/00 09/98→12/06 09/98→06/07			10/98→; für Fahrzeuge mit elektronischer Fahrdynamikregelung		24.2125-1729.3 010752	Ø 25,4
2.0 T.Spark	110	10/00→06/07			→ 10/00; für Fahrzeuge mit elektronischer Fahrdynamikregelung		24.2125-1729.3 010752	Ø 25,4
2.4 JTD 2.5 V6 24V 3.0 V6 24V 3.2 V6 24V	103 - 136 138 162 176	10/00→06/07 10/00→06/07 10/00→06/07 10/00→06/07			für Fahrzeuge mit elektronischer Fahrdynamikregelung		24.2125-1729.3 010752	Ø 25,4
ALFA ROMEO - BRERA (939_) 01/06→05/11								
 Hauptbremszylinder								
1.8 TBi 2.0 JTDM 2.4 JTDM 20V	147 125 147 - 154	05/09→06/10 05/09→06/10 01/06→03/11					24.2125-1732.3 010827	TRW Ø 25,4
3.2 JTS 3.2 JTS Q4	191 191	03/08→06/10 01/06→05/11						
2.0 JTDM	120	03/08→06/10			05/09→		24.2125-1732.3 010827	TRW Ø 25,4
ALFA ROMEO - GIULIETTA (940_) 04/10→12/20								
 Hauptbremszylinder								
1.4 BiFuel 1.4 TB 1.6 JTDM 1.8 TBi 2.0 JTDM	88 77 - 125 77 - 88 169 - 177 100 - 129	12/11→02/17 04/10→12/20 04/10→12/20 04/10→10/18 04/10→12/20					03.2123-3571.3 010962	ATE Ø 23,8
ALFA ROMEO - GIULIETTA Kasten/Schrägheck (940_) 04/11→12/20								
 Hauptbremszylinder								
1.4 1.6 JTDM 1.8 2.0 JTDM	88 - 125 77 173 103 - 129	04/11→12/20 04/11→02/16 04/11→02/16 04/11→12/20					03.2123-3571.3 010962	ATE Ø 23,8
ALFA ROMEO - GTV (916_) 09/94→10/05								
 Hauptbremszylinder								
1.8 16V 2.0 JTS 2.0 T.SPARK 16V	106 121 110 - 114	05/98→10/05 04/03→10/05 06/95→10/05			GG		24.2122-1716.3 010485	Ø 22,2
3.0 V6 24V 3.2 V6 24V	160 - 162 176	10/96→10/05 04/03→10/05						
ALFA ROMEO - MITO (955_) 08/08→10/18								
 Hauptbremszylinder								
0.9 TwinAir 1.4 1.4 MultiAir 1.3 MultiJet 1.4 Bifuel 1.4 MultiAir 1.4 TB 1.4 TJet 1.4 Turbo MultiAir	63 - 77 58 - 70 77 59 - 70 88 125 103 88 - 114 99 - 120	07/11→08/18 08/08→08/13 09/09→08/13 08/08→10/18 01/09→10/18 09/09→10/18 12/13→10/18 08/08→08/13 10/09→10/18					24.4122-1709.3 010871 24.4123-1720.3 011022	BOS Ø 22,2 ohne Bremsflüssigkeitsbehälter BOS Ø 23,8 ohne Bremsflüssigkeitsbehälter
→								

	kw					! #		
ALFA ROMEO - MITO (955_) 08/08→10/18								
 Hauptbremszylinder								
1.6 JTDM	85 - 88	08/08→08/15					24.4123-1720.3 011022	BOS Ø 23,8 ohne Bremsflüssigkeitsbehälter
1.4	57	03/11→10/18		05/11→			24.4122-1709.3 010871 24.4123-1720.3 011022	BOS Ø 22,2 ohne Bremsflüssigkeitsbehälter BOS Ø 23,8 ohne Bremsflüssigkeitsbehälter
1.4	51	05/11→10/18					24.4122-1709.3 010871 24.4123-1720.3 011022	BOS Ø 22,2 ohne Bremsflüssigkeitsbehälter BOS Ø 23,8 ohne Bremsflüssigkeitsbehälter
ALFA ROMEO - SPIDER (916_) 09/94→04/05								
 Hauptbremszylinder								
1.8 16V	106	05/98→04/05		GG			24.2122-1716.3 010485	Ø 22,2
2.0 JTS	121	04/03→04/05						
2.0 T.SPARK 16V	110 - 114	06/95→04/05						
2.0 V6 Turbo	148	05/98→04/05						
3.0 V6	141	06/95→04/05						
3.0 V6 24V	162	01/99→10/03						
3.2 V6 24V	176	04/03→04/05						
3.0 V6	160	09/94→04/05		10/00→; GG			24.2122-1716.3 010485	Ø 22,2
ALFA ROMEO - SPIDER (939_) 03/06→03/11								
 Hauptbremszylinder								
2.2 JTS	136	03/06→03/11		04/06→ 09/06			24.2125-1732.3 010827	TRW Ø 25,4
3.2 JTS Q4	191	03/06→03/11						
AUDI - A1 (8X1, 8XK) 05/10→09/19								
 Hauptbremszylinder								
2.0 TFSI quattro	188	03/12→11/12		10/12→; für Linkslenker			03.2125-5112.3 010966	ATE Ø 25,4
AUDI - A1 Allstreet (GBH) 07/19→								
 Hauptbremszylinder								
25 TFSI	70	07/22→		für Linkslenker; +PR 1ZA / 1ZE / 1ZM / 1ZQ / 1ZS			24.2123-1782.3 011146	TRW Ø 23,8 ohne Bremsflüssigkeitsbehälter
30 TFSI	81 - 85	07/22→						
35 TFSI	110	07/22→						
AUDI - A1 City Carver (GBH) 07/19→06/22								
 Hauptbremszylinder								
25 TFSI	70	07/19→06/22		für Linkslenker; +PR 1ZA / 1ZE / 1ZM / 1ZQ / 1ZS			24.2123-1782.3 011146	TRW Ø 23,8 ohne Bremsflüssigkeitsbehälter
30 TFSI	81 - 85	07/19→06/22						
35 TFSI	110	07/19→06/22						
AUDI - A1 Sportback (GBA) 07/18→								
 Hauptbremszylinder								
25 TFSI	70	11/18→		für Linkslenker; +PR 1ZA / 1ZE / 1ZM / 1ZQ / 1ZS			24.2123-1782.3 011146	TRW Ø 23,8 ohne Bremsflüssigkeitsbehälter
30 TFSI	81 - 85	07/18→						
35 TFSI	110	09/18→						
40 TFSI	147 - 152	09/18→						
AUDI - A2 (8Z0) 02/00→08/05								
 Bremskraftverstärker								
1.2 TDI	45	03/01→08/05		8Z-2-013001→; für Linkslenker; → 07/05			03.7850-0102.4 300180	ATE Ø 9" pneumatisch
				→ 8Z-2-013000; für Linkslenker			03.7853-0202.4 300181	ATE Ø 9" pneumatisch
1.4	55	02/00→08/05		8Z-2-013001→; für Linkslenker; → 07/05			03.7850-0102.4 300180	ATE Ø 9" pneumatisch
1.4 TDI	55	02/00→08/05		06/00→; → 8Z-2-013000; für Linkslenker			03.7853-0202.4 300181	ATE Ø 9" pneumatisch
1.4 TDI	66	11/03→08/05		für Linkslenker; → 07/05			03.7850-0102.4 300180	ATE Ø 9" pneumatisch
1.6 FSI	81	05/02→08/05						
 Hauptbremszylinder								
1.2 TDI	45	03/01→08/05		8Z-3-019001→; → 07/05			03.2122-1888.3 010736	ATE Ø 22,2
1.4	55	02/00→08/05						
1.4 TDI	55	02/00→08/05						
1.6 FSI	81	05/02→08/05						
1.4 TDI	66	11/03→08/05		→ 07/05			03.2122-1888.3 010736	ATE Ø 22,2

	kw			 	! #		
AUDI - A3 (8L1) 09/96→09/06							
 Bremskraftverstärker							
1.6	74 - 75	09/96→05/03		09/00→; → 8L-2-037877; für Linkslenker; + ESP	03.7860-0602.4	300141	ATE Ø 10" pneumatisch
1.8	92	09/96→05/03		→ 08/00; + ESP; für Linkslenker	03.7863-0402.4	300124	ATE Ø 10" pneumatisch
1.8 T	110 - 132	12/96→05/03		8L-2-037878→; für Linkslenker; + ESP	03.7863-3502.4	300128	ATE Ø 10" pneumatisch
1.8 T quattro	132	10/98→05/03					
S3 quattro	154	03/99→04/02					
1.8 T quattro	110	12/96→05/03		09/00→; → 8L-2-037877; für Linkslenker; + ESP	03.7860-0602.4	300141	ATE Ø 10" pneumatisch
				08/98→ 08/00; für Linkslenker; + ESP	03.7863-0402.4	300124	ATE Ø 10" pneumatisch
				8L-2-037878→; für Linkslenker; + ESP	03.7863-3502.4	300128	ATE Ø 10" pneumatisch
1.9 TDI	66 - 81	09/96→07/01		09/00→ 06/01; für Linkslenker; + ESP	03.7860-0602.4	300141	ATE Ø 10" pneumatisch
				→ 08/00; + ESP; für Linkslenker	03.7863-0402.4	300124	ATE Ø 10" pneumatisch
1.9 TDI	74	10/00→05/03		→ 8L-2-037877; für Linkslenker; + ESP	03.7860-0602.4	300141	ATE Ø 10" pneumatisch
S3 quattro	165	10/01→05/03		8L-2-037878→; für Linkslenker; + ESP	03.7863-3502.4	300128	ATE Ø 10" pneumatisch
1.9 TDI	96	08/00→05/03		09/00→; → 8L-2-037877; für Linkslenker; + ESP	03.7860-0602.4	300141	ATE Ø 10" pneumatisch
1.9 TDI quattro	96	08/00→05/03					
				8L-2-037878→; für Linkslenker; + ESP	03.7863-3502.4	300128	ATE Ø 10" pneumatisch
 Hauptbremszylinder							
1.6	74 - 75	09/96→05/03		→ 08/00; für Linkslenker; + ESP	03.2123-2024.3	010597	ATE Ø 23,8
1.8	92	09/96→05/03		09/00→; für Linkslenker; + ESP	03.2123-2715.3	010802	ATE Ø 23,8
1.8 T	110 - 132	12/96→05/03		09/00→; für Rechtslenker; + ESP	03.2123-2774.3	010803	ATE Ø 23,8
S3 quattro	154	03/99→04/02		für Linkslenker; - ESP	24.2123-1709.3	010503	Ø 23,8
1.8 T quattro	110	12/96→05/03		09/00→; für Linkslenker; + ESP	03.2123-2715.3	010802	ATE Ø 23,8
				09/00→; für Rechtslenker; + ESP	03.2123-2774.3	010803	ATE Ø 23,8
				08/98→; - ESP; für Linkslenker	24.2123-1709.3	010503	Ø 23,8
1.8 T quattro	132	10/98→05/03		09/00→; für Linkslenker; + ESP	03.2123-2715.3	010802	ATE Ø 23,8
				09/00→; für Rechtslenker; + ESP	03.2123-2774.3	010803	ATE Ø 23,8
				für Linkslenker; - ESP	24.2123-1709.3	010503	Ø 23,8
1.9 TDI	66 - 81	09/96→07/01		→ 08/00; für Linkslenker; + ESP	03.2123-2024.3	010597	ATE Ø 23,8
				09/00→ 06/01; für Linkslenker; + ESP	03.2123-2715.3	010802	ATE Ø 23,8
				09/00→ 06/01; für Rechtslenker; + ESP	03.2123-2774.3	010803	ATE Ø 23,8
				→ 06/01; für Linkslenker; - ESP	24.2123-1709.3	010503	Ø 23,8
1.9 TDI	74	10/00→05/03		für Linkslenker; + ESP	03.2123-2715.3	010802	ATE Ø 23,8
S3 quattro	165	10/01→05/03		für Rechtslenker; + ESP	03.2123-2774.3	010803	ATE Ø 23,8
				für Linkslenker; - ESP	24.2123-1709.3	010503	Ø 23,8
1.9 TDI	96	08/00→05/03		09/00→; für Linkslenker; + ESP	03.2123-2715.3	010802	ATE Ø 23,8
1.9 TDI quattro	96	08/00→05/03		09/00→; für Rechtslenker; + ESP	03.2123-2774.3	010803	ATE Ø 23,8
				09/00→; - ESP; für Linkslenker	24.2123-1709.3	010503	Ø 23,8
AUDI - A3 (8P1) 05/03→12/13							
 Bremskraftverstärker							
1.2 TSI	77	04/10→08/12		für Linkslenker; +PR 1AC / 1AT	03.7863-3232.4	300307	ATE Ø 10" pneumatisch
1.4 TFSI	92	09/07→08/12					
1.6	75	05/03→08/12					
1.6 E-Power	75	01/11→08/12					
1.6 FSI	85	08/03→09/07					
1.6 TDI	66 - 77	05/09→08/12					
1.8 TFSI quattro	118	07/08→08/12					
2.0 FSI	110	05/03→06/08					
2.0 TDI	100 - 125	05/03→08/12					
2.0 TDI 16V	103	05/03→08/12					
2.0 TDI 16V quattro	103	08/04→08/12					
2.0 TDI quattro	100 - 125	05/03→08/12					
2.0 TFSI	147	09/04→08/12					
2.0 TFSI quattro	147	09/04→08/12					
1.8 T	110	08/06→08/12		01/07→; +PR 1AC / 1AT; für Linkslenker	03.7863-3232.4	300307	ATE Ø 10" pneumatisch
1.8 TFSI	118	11/06→08/12					
1.9 TDI	77	05/03→05/10		06/03→; für Linkslenker; +PR 1AC / 1AT	03.7863-3232.4	300307	ATE Ø 10" pneumatisch
3.2 V6 quattro	184	07/03→05/09		für Linkslenker	03.7863-3332.4	300308	ATE Ø 10" pneumatisch
S3 quattro	195	11/06→08/12					
S3 quattro	188	02/07→08/12		07/08→; für Linkslenker	03.7863-3332.4	300308	ATE Ø 10" pneumatisch
→							

	kw			 	! #				
AUDI - A3 (8P1) 05/03→12/13									
 Hauptbremszylinder									
1.2 TSI	77	04/10→08/12	für Linkslenker; +PR 1ZE / 1ZF / 1ZP / 1ZD / 1LJ / 1ZM	03.2122-2129.3	010799	ATE Ø 22,2			
			8P-6A094001→; für Linkslenker; +PR 1ZE / 1ZF / 1ZP / 1ZD / 1LJ / 1ZM	03.2122-2129.3	010799	ATE Ø 22,2			
			für Linkslenker; → 8P-6B009600; +PR 1ZE / 1ZF / 1ZP / 1ZD / 1LJ / 1ZM	03.2122-2129.3	010799	ATE Ø 22,2			
			für Linkslenker; → 8P-6A094000; +PR 1ZE / 1ZF / 1ZP / 1ZD / 1LJ / 1ZM	03.2122-2129.3	010799	ATE Ø 22,2			
			8P-6A094001→; für Linkslenker; +PR 1LK / 1ZK	03.2123-3449.3	010808	ATE Ø 23,8			
			für Linkslenker; +PR 1LK / 1ZK	03.2123-3449.3	010808	ATE Ø 23,8			
			für Linkslenker; → 8P-6A094000; +PR 1LK	03.2123-3449.3	010808	ATE Ø 23,8			
			für Linkslenker; → 8P-6B009600; +PR 1LK	03.2123-3449.3	010808	ATE Ø 23,8			
			für Rechtslenker	24.2122-1981.3	011024	ATE Ø 22,2 ohne Bremsflüssigkeitsbehälter			
1.4 TFSI	92	09/07→08/12	für Linkslenker; +PR 1ZE / 1ZF / 1ZP / 1ZD / 1LJ / 1ZM	03.2122-2129.3	010799	ATE Ø 22,2			
			für Linkslenker; +PR 1LK / 1ZK	03.2123-3449.3	010808	ATE Ø 23,8			
			für Rechtslenker	24.2122-1981.3	011024	ATE Ø 22,2 ohne Bremsflüssigkeitsbehälter			
1.6 1.6 E-Power 1.6 FSI 1.6 TDI 2.0 FSI 2.0 TDI 2.0 TDI 16V 2.0 TDI 16V quattro 2.0 TDI quattro	75 75 85 66 - 77 110 100 - 103 103 100 - 103	05/03→08/12 01/11→08/12 08/03→09/07 05/09→08/12 05/03→06/08 05/03→08/12 05/03→08/12 08/04→08/12 05/03→06/08 05/03→06/08	8P-6A094001→; für Linkslenker; +PR 1ZE / 1ZF / 1ZP / 1ZD / 1LJ / 1ZM	03.2122-2129.3	010799	ATE Ø 22,2			
			8P-6B009601→; für Linkslenker; +PR 1ZE / 1ZF / 1ZP / 1ZD / 1LJ / 1ZM	03.2122-2129.3	010799	ATE Ø 22,2			
			für Linkslenker; → 8P-6A094000; +PR 1ZE / 1ZF / 1ZP / 1ZD / 1LJ / 1ZM	03.2122-2129.3	010799	ATE Ø 22,2			
			für Linkslenker; → 8P-6B009600; +PR 1ZE / 1ZF / 1ZP / 1ZD / 1LJ / 1ZM	03.2122-2129.3	010799	ATE Ø 22,2			
			8P-6A094001→; für Linkslenker; +PR 1LK / 1ZK	03.2123-3449.3	010808	ATE Ø 23,8			
			8P-6B009601→; für Linkslenker; +PR 1LK / 1ZK	03.2123-3449.3	010808	ATE Ø 23,8			
			für Linkslenker; → 8P-6A094000; +PR 1LK	03.2123-3449.3	010808	ATE Ø 23,8			
			für Linkslenker; → 8P-6B009600; +PR 1LK	03.2123-3449.3	010808	ATE Ø 23,8			
			für Rechtslenker	24.2122-1981.3	011024	ATE Ø 22,2 ohne Bremsflüssigkeitsbehälter			
			1.8 T 1.8 TFSI	110 118	08/06→08/12 11/06→08/12	01/07→; für Linkslenker; +PR 1ZE / 1ZF / 1ZP / 1ZD / 1LJ / 1ZM	03.2122-2129.3	010799	ATE Ø 22,2
						01/07→; für Linkslenker; +PR 1LK / 1ZK	03.2123-3449.3	010808	ATE Ø 23,8
						01/07→; für Rechtslenker	24.2122-1981.3	011024	ATE Ø 22,2 ohne Bremsflüssigkeitsbehälter
1.8 TFSI quattro	118	07/08→08/12	für Linkslenker; +PR 1ZE / 1ZF / 1ZP / 1ZD / 1LJ / 1ZM	03.2122-2129.3	010799	ATE Ø 22,2			
			für Linkslenker; +PR 1LK / 1ZK	03.2123-3449.3	010808	ATE Ø 23,8			
1.9 TDI	77	05/03→05/10	06/03→; für Linkslenker; → 8P-6A094000; +PR 1ZE / 1ZF / 1ZP / 1ZD / 1LJ / 1ZM	03.2122-2129.3	010799	ATE Ø 22,2			
			06/03→; für Linkslenker; → 8P-6B009600; +PR 1ZE / 1ZF / 1ZP / 1ZD / 1LJ / 1ZM	03.2122-2129.3	010799	ATE Ø 22,2			
			8P-6B009601→; für Linkslenker; +PR 1ZE / 1ZF / 1ZP / 1ZD / 1LJ / 1ZM	03.2122-2129.3	010799	ATE Ø 22,2			
			8P-6A094001→; für Linkslenker; +PR 1ZE / 1ZF / 1ZP / 1ZD / 1LJ / 1ZM	03.2122-2129.3	010799	ATE Ø 22,2			
			06/03→; für Linkslenker; → 8P-6B009600; +PR 1LK	03.2123-3449.3	010808	ATE Ø 23,8			
			06/03→; für Linkslenker; → 8P-6A094000; +PR 1LK	03.2123-3449.3	010808	ATE Ø 23,8			
			8P-6B009601→; für Linkslenker; +PR 1LK / 1ZK	03.2123-3449.3	010808	ATE Ø 23,8			
			8P-6A094001→; für Linkslenker; +PR 1LK / 1ZK	03.2123-3449.3	010808	ATE Ø 23,8			
			06/03→; für Rechtslenker	24.2122-1981.3	011024	ATE Ø 22,2 ohne Bremsflüssigkeitsbehälter			
2.0 TDI	120	06/06→06/08	8P-6A094001→; für Linkslenker; +PR 1ZE / 1ZF / 1ZP / 1ZD / 1LJ / 1ZM	03.2122-2129.3	010799	ATE Ø 22,2			
			8P-6B009601→; für Linkslenker; +PR 1ZE / 1ZF / 1ZP / 1ZD / 1LJ / 1ZM	03.2122-2129.3	010799	ATE Ø 22,2			
			für Linkslenker; → 8P-6B009600; +PR 1ZE / 1ZF / 1ZP / 1ZD / 1LJ / 1ZM	03.2122-2129.3	010799	ATE Ø 22,2			



AUDI - A3 (8P1) 05/03→12/13

Hauptbremszylinder

2.0 TDI	120	06/06→06/08		für Linkslenker; → 8P-6A094000; +PR 1ZE / 1ZF / 1ZP / 1ZD / 1LJ / 1ZM	03.2122-2129.3	010799	ATE Ø 22,2
				8P-6A094001→; für Linkslenker; +PR 1LK / 1ZK	03.2123-3449.3	010808	ATE Ø 23,8
				für Linkslenker; → 8P-6B009600; +PR 1LK	03.2123-3449.3	010808	ATE Ø 23,8
				für Linkslenker; → 8P-6A094000; +PR 1LK	03.2123-3449.3	010808	ATE Ø 23,8
				für Rechtslenker	24.2122-1981.3	011024	ATE Ø 22,2 ohne Bremsflüssigkeitsbehälter
2.0 TDI 2.0 TDI quattro	125 125	03/06→08/12 03/06→08/12		+PR 1ZE / 1ZF / 1ZP / 1ZD / 1LJ / 1ZM	03.2123-3449.3	010808	ATE Ø 23,8
				für Linkslenker; +PR 1LK / 1ZK	03.2123-3449.3	010808	ATE Ø 23,8
				für Rechtslenker	24.2122-1981.3	011024	ATE Ø 22,2 ohne Bremsflüssigkeitsbehälter
2.0 TFSI 2.0 TFSI quattro	147 147	09/04→08/12 09/04→08/12		8P-6B009601→; für Linkslenker; → 8P-7-103000; +PR 1ZE / 1ZF / 1ZP / 1ZD / 1LJ / 1ZM	03.2122-2129.3	010799	ATE Ø 22,2
				8P-6A094001→; für Linkslenker; → 8P-7-103000; +PR 1ZE / 1ZF / 1ZP / 1ZD / 1LJ / 1ZM	03.2122-2129.3	010799	ATE Ø 22,2
				für Linkslenker; → 8P-6A094000; +PR 1ZE / 1ZF / 1ZP / 1ZD / 1LJ / 1ZM	03.2122-2129.3	010799	ATE Ø 22,2
				für Linkslenker; → 8P-6B009600; +PR 1ZE / 1ZF / 1ZP / 1ZD / 1LJ / 1ZM	03.2122-2129.3	010799	ATE Ø 22,2
				8P-6B009601→; für Linkslenker; → 8P-7-103000; +PR 1LK / 1ZK	03.2123-3449.3	010808	ATE Ø 23,8
				8P-7-103001→; +PR 1ZE / 1ZF / 1ZP / 1ZD / 1LJ / 1ZM	03.2123-3449.3	010808	ATE Ø 23,8
				8P-6A094001→; für Linkslenker; → 8P-7-103000; +PR 1LK / 1ZK	03.2123-3449.3	010808	ATE Ø 23,8
				für Linkslenker; → 8P-6A094000; +PR 1LK	03.2123-3449.3	010808	ATE Ø 23,8
				für Linkslenker; → 8P-6B009600; +PR 1LK	03.2123-3449.3	010808	ATE Ø 23,8
				für Rechtslenker	24.2122-1981.3	011024	ATE Ø 22,2 ohne Bremsflüssigkeitsbehälter
3.2 V6 quattro S3 quattro	184 195	07/03→05/09 11/06→08/12		für Linkslenker; - ESP	03.2122-2129.3	010799	ATE Ø 22,2
				für Linkslenker; + ESP	03.2123-3449.3	010808	ATE Ø 23,8
				für Rechtslenker; - ESP	24.2122-1981.3	011024	ATE Ø 22,2 ohne Bremsflüssigkeitsbehälter
S3 quattro	188	02/07→08/12		07/08→; für Linkslenker; - ESP	03.2122-2129.3	010799	ATE Ø 22,2
				07/08→; für Linkslenker; + ESP	03.2123-3449.3	010808	ATE Ø 23,8
				07/08→; für Rechtslenker; - ESP	24.2122-1981.3	011024	ATE Ø 22,2 ohne Bremsflüssigkeitsbehälter













Drucksensor, Bremskraftverstärker

1.2 TSI 1.4 TFSI 1.6 1.6 E-Power 1.6 FSI 1.6 TDI 1.8 TFSI quattro 2.0 FSI 2.0 TDI 2.0 TDI 16V 2.0 TDI 16V quattro 2.0 TDI quattro 2.0 TFSI 2.0 TFSI quattro 1.8 T 1.8 TFSI 1.9 TDI	77 92 75 75 85 66 - 77 118 110 100 - 125 103 103 100 - 125 147 147 110 118 77	04/10→08/12 09/07→08/12 05/03→08/12 01/11→08/12 08/03→09/07 05/09→08/12 07/08→08/12 05/03→06/08 05/03→08/12 05/03→08/12 08/04→08/12 05/03→08/12 09/04→08/12 09/04→08/12 08/06→08/12 11/06→08/12 05/03→05/10		für Linkslenker; +PR 1AS	03.0655-0101.2	370008	ATE		
				01/07→; +PR 1AS; für Linkslenker	03.0655-0101.2	370008	ATE		
				06/03→; für Linkslenker; +PR 1AS	03.0655-0101.2	370008	ATE		

AUDI - A3 (8V1, 8VK) 04/12→10/20

Hauptbremszylinder

1.0 TFSI 1.2 TFSI 1.4 TFSI →	85 77 - 81 90 - 103	07/16→12/17 02/13→08/16 04/12→08/16		für Linkslenker	03.4153-5403.3	010994	ATE Ø 23,8		
					24.4123-1719.3	011017	TRW Ø 23,8 ohne Bremsflüssigkeitsbehälter		

	kw			 	! #		
AUDI - A3 (8V1, 8VK) 04/12→10/20							
 Hauptbremszylinder							
1.4 TFSI 1.5 TFSI 1.6 TDI 1.8 TFSI 1.8 TFSI quattro 2.0 TDI 2.0 TDI quattro 2.0 TFSI 2.0 TFSI quattro S3 quattro	110 110 77 - 85 132 132 81 - 135 110 - 135 140 140 206 - 228	05/14→12/17 05/17→12/17 10/12→10/20 04/12→08/16 08/12→08/16 04/12→10/20 10/12→12/17 05/16→12/17 05/16→12/17 11/12→12/17		für Linkslenker		24.4153-1522.3 011048	ATE Ø 23,8 ohne Bremsflüssigkeitsbehälter
AUDI - A3 Cabriolet (8P7) 04/08→05/13							
 Bremskraftverstärker							
1.2 TFSI 1.4 TFSI 1.6 1.6 TDI 1.8 TFSI 1.9 TDI 2.0 TDI 2.0 TFSI	77 92 75 77 118 77 100 - 103 147	03/10→05/13 02/11→05/13 09/08→05/10 05/09→05/13 04/08→05/13 04/08→10/09 04/08→05/13 04/08→05/13		für Linkslenker; +PR 1ZE / 1ZF / 1LJ / 1ZA		03.7863-3232.4 300307	ATE Ø 10" pneumatisch
				für Linkslenker; +PR 1ZE / 1ZF / 1LJ		03.7863-3332.4 300308	ATE Ø 10" pneumatisch
 Hauptbremszylinder							
1.2 TFSI 1.4 TFSI 1.6 1.6 TDI 1.8 TFSI 1.9 TDI 2.0 TDI 2.0 TFSI	77 92 75 77 118 77 100 - 103 147	03/10→05/13 02/11→05/13 09/08→05/10 05/09→05/13 04/08→05/13 04/08→10/09 04/08→05/13 04/08→05/13		für Linkslenker; +PR 1ZE / 1ZF / 1LJ / 1ZA		03.2122-2129.3 010799	ATE Ø 22,2
				für Linkslenker; +PR 1ZE / 1ZF / 1LJ / 1ZA		03.2123-3449.3 010808	ATE Ø 23,8
AUDI - A3 Cabriolet (8V7, 8VE) 10/13→04/21							
 Hauptbremszylinder							
1.4 TFSI 1.4 TFSI 1.5 TFSI 1.6 TDI 1.8 TFSI 1.8 TFSI quattro 2.0 TDI 2.0 TDI quattro 2.0 TFSI 2.0 TFSI quattro 35 TFSI 40 TFSI 40 TFSI quattro S3 quattro	85 - 103 110 110 81 - 85 125 - 132 132 100 - 135 110 - 135 140 140 110 140 140 210 - 228	10/13→10/20 05/14→10/20 05/17→10/18 02/14→10/20 10/13→10/20 03/14→07/16 10/13→10/20 03/14→10/20 05/16→10/20 05/14→10/20 10/18→10/20 11/18→10/20 11/18→10/20 03/14→10/20		für Linkslenker		03.4153-5403.3 010994 24.4123-1719.3 011017 24.4153-1522.3 011048	ATE Ø 23,8 TRW Ø 23,8 ohne Bremsflüssigkeitsbehälter ATE Ø 23,8 ohne Bremsflüssigkeitsbehälter
AUDI - A3 Limousine (8VS, 8VM) 05/13→08/21							
 Hauptbremszylinder							
1.0 TFSI 1.2 TFSI 1.4 TFSI 1.4 TFSI 1.5 TFSI 1.6 TDI 1.6 TDI quattro 1.8 TFSI 1.8 TFSI quattro	85 77 - 81 90 - 103 110 110 77 - 85 81 125 - 132 132	07/16→10/20 10/13→08/16 05/13→10/20 05/14→10/20 05/17→10/18 09/13→10/20 05/15→08/16 05/13→10/20 11/13→08/16		für Linkslenker		03.4153-5403.3 010994 24.4123-1719.3 011017 24.4153-1522.3 011048	ATE Ø 23,8 TRW Ø 23,8 ohne Bremsflüssigkeitsbehälter ATE Ø 23,8 ohne Bremsflüssigkeitsbehälter



AUDI - A3 Limousine (8VS, 8VM) 05/13→08/21

Hauptbremszylinder

2.0 TDI	81 - 135	05/13→10/20		für Linkslenker	03.4153-5403.3	010994	ATE Ø 23,8
2.0 TDI quattro	110 - 135	10/13→10/20			24.4123-1719.3	011017	TRW Ø 23,8 ohne Bremsflüssigkeitsbehälter
2.0 TFSI	140 - 162	11/15→10/20			24.4153-1522.3	011048	ATE Ø 23,8 ohne Bremsflüssigkeitsbehälter
2.0 TFSI quattro	140	05/16→10/20					
30 TDI	85	07/18→10/20					
30 TFSI	85	07/18→10/20					
35 TDI	110	07/18→10/20					
35 TFSI	110	10/18→10/20					
40 TDI quattro	135	07/18→07/19					
40 TFSI	140	07/18→10/20					
40 TFSI quattro	140	07/18→10/20					
RS3 quattro	294	04/17→10/20					
S3 quattro	206 - 228	10/13→10/20					







AUDI - A3 Sportback (8PA) 09/04→12/15







Bremskraftverstärker









1.2 TSI	77	04/10→03/13		für Linkslenker; +PR 1AC / 1AT	03.7863-3232.4	300307	ATE Ø 10" pneumatisch
1.4 TFSI	92	09/07→03/13					
1.6	75	09/04→03/13					
1.6 E-Power	75	01/11→03/13					
1.6 FSI	85	09/04→09/07					
1.6 TDI	66 - 77	05/09→03/13					
1.8 TFSI quattro	118	07/08→03/13					
1.9 TDI	77	09/04→05/10					
2.0 FSI	110	09/04→06/08					
2.0 TDI	100 - 125	09/04→03/13					
2.0 TDI 16V	103	09/04→03/13					
2.0 TDI 16V quattro	103	11/05→03/13					
2.0 TDI quattro	103 - 125	01/06→03/13					
2.0 TFSI	147	09/04→03/13					
2.0 TFSI quattro	147	09/04→03/13					
1.8 TFSI	118	11/06→03/13		01/07→; +PR 1AC / 1AT; für Linkslenker	03.7863-3232.4	300307	ATE Ø 10" pneumatisch
3.2 V6 quattro	184	09/04→05/09		für Linkslenker	03.7863-3332.4	300308	ATE Ø 10" pneumatisch
S3 quattro	188 - 195	06/08→03/13					

Hauptbremszylinder

1.2 TSI	77	04/10→03/13		für Linkslenker; +PR 1ZE / 1ZF / 1ZP / 1ZD / 1LJ / 1ZM	03.2122-2129.3	010799	ATE Ø 22,2
				8P-6A094001→; für Linkslenker; +PR 1ZE / 1ZF / 1ZP / 1ZD / 1LJ / 1ZM	03.2122-2129.3	010799	ATE Ø 22,2
				für Linkslenker; → 8P-6B009600; +PR 1ZE / 1ZF / 1ZP / 1ZD / 1LJ / 1ZM	03.2122-2129.3	010799	ATE Ø 22,2
				für Linkslenker; → 8P-6A094000; +PR 1ZE / 1ZF / 1ZP / 1ZD / 1LJ / 1ZM	03.2122-2129.3	010799	ATE Ø 22,2
				8P-6A094001→; für Linkslenker; +PR 1LK / 1ZK	03.2123-3449.3	010808	ATE Ø 23,8
				für Linkslenker; +PR 1LK / 1ZK	03.2123-3449.3	010808	ATE Ø 23,8
				für Linkslenker; → 8P-6B009600; +PR 1LK	03.2123-3449.3	010808	ATE Ø 23,8
				für Linkslenker; → 8P-6A094000; +PR 1LK	03.2123-3449.3	010808	ATE Ø 23,8
				für Rechtslenker	24.2122-1981.3	011024	ATE Ø 22,2 ohne Bremsflüssigkeitsbehälter
1.4 TFSI	92	09/07→03/13		für Linkslenker; +PR 1ZE / 1ZF / 1ZP / 1ZD / 1LJ / 1ZM	03.2122-2129.3	010799	ATE Ø 22,2
				für Linkslenker; +PR 1LK / 1ZK	03.2123-3449.3	010808	ATE Ø 23,8
				für Rechtslenker	24.2122-1981.3	011024	ATE Ø 22,2 ohne Bremsflüssigkeitsbehälter
1.6	75	09/04→03/13		8P-6A094001→; für Linkslenker; +PR 1ZE / 1ZF / 1ZP / 1ZD / 1LJ / 1ZM	03.2122-2129.3	010799	ATE Ø 22,2
1.6 E-Power	75	01/11→03/13					
1.6 FSI	85	09/04→09/07		8P-6B009601→; für Linkslenker; +PR 1ZE / 1ZF / 1ZP / 1ZD / 1LJ / 1ZM	03.2122-2129.3	010799	ATE Ø 22,2
1.6 TDI	66 - 77	05/09→03/13					
1.9 TDI	77	09/04→05/10		für Linkslenker; → 8P-6A094000; +PR 1ZE / 1ZF / 1ZP / 1ZD / 1LJ / 1ZM	03.2122-2129.3	010799	ATE Ø 22,2
2.0 FSI	110	09/04→06/08					
2.0 TDI	100 - 103	09/04→03/13		für Linkslenker; → 8P-6B009600; +PR 1ZE / 1ZF / 1ZP / 1ZD / 1LJ / 1ZM	03.2122-2129.3	010799	ATE Ø 22,2
2.0 TDI 16V	103	09/04→03/13		8P-6B009601→; für Linkslenker; +PR 1LK / 1ZK	03.2123-3449.3	010808	ATE Ø 23,8
2.0 TDI 16V quattro	103	11/05→03/13					
2.0 TDI quattro	103	01/06→06/08					

	kw			 	! #		
AUDI - A3 Sportback (8PA) 09/04→12/15							
Hauptbremszylinder							
1.6	75	09/04→03/13		8P-6A094001→; für Linkslenker; +PR 1LK / 1ZK		03.2123-3449.3 010808	ATE Ø 23,8
1.6 E-Power	75	01/11→03/13					
1.6 FSI	85	09/04→09/07		für Linkslenker; → 8P-6B009600; +PR 1LK		03.2123-3449.3 010808	ATE Ø 23,8
1.6 TDI	66 - 77	05/09→03/13					
1.9 TDI	77	09/04→05/10		für Linkslenker; → 8P-6A094000; +PR 1LK		03.2123-3449.3 010808	ATE Ø 23,8
2.0 FSI	110	09/04→06/08					
2.0 TDI	100 - 103	09/04→03/13		für Rechtslenker		24.2122-1981.3 011024	ATE Ø 22,2 ohne Bremsflüssigkeitsbehälter
2.0 TDI 16V	103	09/04→03/13					
2.0 TDI 16V quattro	103	11/05→03/13					
2.0 TDI quattro	103	01/06→06/08					
1.8 TFSI	118	11/06→03/13		01/07→; für Linkslenker; +PR 1ZE / 1ZF / 1ZP / 1ZD / 1LJ / 1ZM		03.2122-2129.3 010799	ATE Ø 22,2
				01/07→; für Linkslenker; +PR 1LK / 1ZK		03.2123-3449.3 010808	ATE Ø 23,8
				01/07→; für Rechtslenker		24.2122-1981.3 011024	ATE Ø 22,2 ohne Bremsflüssigkeitsbehälter
1.8 TFSI quattro	118	07/08→03/13		für Linkslenker; +PR 1ZE / 1ZF / 1ZP / 1ZD / 1LJ / 1ZM		03.2122-2129.3 010799	ATE Ø 22,2
				für Linkslenker; +PR 1LK / 1ZK		03.2123-3449.3 010808	ATE Ø 23,8
2.0 TDI	104	01/10→03/13		8P-6A094001→; für Linkslenker; +PR 1ZE / 1ZF / 1ZP / 1ZD / 1LJ / 1ZM		03.2122-2129.3 010799	ATE Ø 22,2
				8P-6A094001→; für Linkslenker; +PR 1LK / 1ZK		03.2123-3449.3 010808	ATE Ø 23,8
				für Rechtslenker		24.2122-1981.3 011024	ATE Ø 22,2 ohne Bremsflüssigkeitsbehälter
2.0 TDI	120	06/06→06/08		8P-6A094001→; für Linkslenker; +PR 1ZE / 1ZF / 1ZP / 1ZD / 1LJ / 1ZM		03.2122-2129.3 010799	ATE Ø 22,2
				8P-6B009601→; für Linkslenker; +PR 1ZE / 1ZF / 1ZP / 1ZD / 1LJ / 1ZM		03.2122-2129.3 010799	ATE Ø 22,2
				für Linkslenker; → 8P-6B009600; +PR 1ZE / 1ZF / 1ZP / 1ZD / 1LJ / 1ZM		03.2122-2129.3 010799	ATE Ø 22,2
				für Linkslenker; → 8P-6A094000; +PR 1ZE / 1ZF / 1ZP / 1ZD / 1LJ / 1ZM		03.2122-2129.3 010799	ATE Ø 22,2
				8P-6A094001→; für Linkslenker; +PR 1LK / 1ZK		03.2123-3449.3 010808	ATE Ø 23,8
				für Linkslenker; → 8P-6A094000; +PR 1LK		03.2123-3449.3 010808	ATE Ø 23,8
				für Linkslenker; → 8P-6B009600; +PR 1LK		03.2123-3449.3 010808	ATE Ø 23,8
				für Rechtslenker		24.2122-1981.3 011024	ATE Ø 22,2 ohne Bremsflüssigkeitsbehälter
2.0 TDI	125	03/06→03/13		+PR 1ZE / 1ZF / 1ZP / 1ZD / 1LJ / 1ZM		03.2123-3449.3 010808	ATE Ø 23,8
2.0 TDI quattro	125	03/06→03/13		für Linkslenker; +PR 1LK / 1ZK		03.2123-3449.3 010808	ATE Ø 23,8
				für Rechtslenker		24.2122-1981.3 011024	ATE Ø 22,2 ohne Bremsflüssigkeitsbehälter
2.0 TFSI	147	09/04→03/13		8P-6B009601→; für Linkslenker; → 8P-7-103000; +PR 1ZE / 1ZF / 1ZP / 1ZD / 1LJ / 1ZM		03.2122-2129.3 010799	ATE Ø 22,2
2.0 TFSI quattro	147	09/04→03/13		8P-6A094001→; für Linkslenker; → 8P-7-103000; +PR 1ZE / 1ZF / 1ZP / 1ZD / 1LJ / 1ZM		03.2122-2129.3 010799	ATE Ø 22,2
				für Linkslenker; → 8P-6A094000; +PR 1ZE / 1ZF / 1ZP / 1ZD / 1LJ / 1ZM		03.2122-2129.3 010799	ATE Ø 22,2
				für Linkslenker; → 8P-6B009600; +PR 1ZE / 1ZF / 1ZP / 1ZD / 1LJ / 1ZM		03.2122-2129.3 010799	ATE Ø 22,2
				8P-6B009601→; für Linkslenker; → 8P-7-103000; +PR 1LK / 1ZK		03.2123-3449.3 010808	ATE Ø 23,8
				8P-7-103001→; +PR 1ZE / 1ZF / 1ZP / 1ZD / 1LJ / 1ZM		03.2123-3449.3 010808	ATE Ø 23,8
				8P-6A094001→; für Linkslenker; → 8P-7-103000; +PR 1LK / 1ZK		03.2123-3449.3 010808	ATE Ø 23,8
				für Linkslenker; → 8P-6B009600; +PR 1LK		03.2123-3449.3 010808	ATE Ø 23,8
				für Linkslenker; → 8P-6A094000; +PR 1LK		03.2123-3449.3 010808	ATE Ø 23,8
				für Rechtslenker		24.2122-1981.3 011024	ATE Ø 22,2 ohne Bremsflüssigkeitsbehälter
3.2 V6 quattro	184	09/04→05/09		für Linkslenker; - ESP		03.2122-2129.3 010799	ATE Ø 22,2
S3 quattro	188 - 195	06/08→03/13		für Linkslenker; + ESP		03.2123-3449.3 010808	ATE Ø 23,8
				für Rechtslenker; - ESP		24.2122-1981.3 011024	ATE Ø 22,2 ohne Bremsflüssigkeitsbehälter
RS3 quattro	250	01/11→12/12		04/11→; für Linkslenker		03.2125-5112.3 010966	ATE Ø 25,4

	kW			 	! #		
AUDI - A3 Sportback (8PA) 09/04→12/15							
Drucksensor, Bremskraftverstärker							
1.2 TSI	77	04/10→03/13		für Linkslenker; +PR 1AS		03.0655-0101.2 370008	ATE
1.4 TFSI	92	09/07→03/13					
1.6	75	09/04→03/13					
1.6 E-Power	75	01/11→03/13					
1.6 FSI	85	09/04→09/07					
1.6 TDI	66 - 77	05/09→03/13					
1.8 TFSI quattro	118	07/08→03/13					
1.9 TDI	77	09/04→05/10					
2.0 FSI	110	09/04→06/08					
2.0 TDI	100 - 125	09/04→03/13					
2.0 TDI 16V	103	09/04→03/13					
2.0 TDI 16V quattro	103	11/05→03/13					
2.0 TDI quattro	103 - 125	01/06→03/13					
2.0 TFSI	147	09/04→03/13					
2.0 TFSI quattro	147	09/04→03/13					
1.8 TFSI	118	11/06→03/13		01/07→; +PR 1AS; für Linkslenker		03.0655-0101.2 370008	ATE
AUDI - A3 Sportback (8VA, 8VF) 09/12→08/21							
Hauptbremszylinder							
1.0 TFSI	85	07/16→10/20		für Linkslenker		03.4153-5403.3 010994	ATE Ø 23,8
1.2 TFSI	77 - 81	05/13→08/16				24.4123-1719.3 011017	TRW Ø 23,8 ohne Bremsflüssigkeitsbehälter
1.4 TFSI	90 - 103	09/12→10/20				24.4153-1522.3 011048	ATE Ø 23,8 ohne Bremsflüssigkeitsbehälter
1.4 TFSI e-tron	150	05/14→10/20					
1.4 TFSI g-tron	81	11/13→10/20					
1.4 TSI	110	05/14→10/20					
1.5 TFSI	110	05/17→10/18					
1.6 TDI	77 - 85	10/12→10/20					
1.6 TDI quattro	81	05/15→08/16					
1.8 TFSI	132	09/12→08/16					
1.8 TFSI quattro	132	05/13→08/16					
2.0 TDI	81 - 135	09/12→10/20					
2.0 TDI quattro	110 - 135	02/13→10/20					
2.0 TFSI	140	05/16→10/20					
2.0 TFSI quattro	140	05/16→10/20					
30 g-tron	96	11/18→10/20					
30 TDI	85	07/18→10/20					
30 TFSI	85	07/18→10/20					
35 TDI	110	07/18→10/20					
35 TFSI	110	10/18→10/20					
40 e-tron	150	07/18→10/20					
40 TDI quattro	135	07/18→10/20					
40 TFSI	140	07/18→10/20					
40 TFSI quattro	140	07/18→10/20					
RS3 quattro	270 - 294	03/15→10/20					
S3 quattro	206 - 228	11/12→10/20					
AUDI - A4 Allroad B8 (8KH) 04/09→06/17							
Bremskraftverstärker							
2.0 TDI quattro	100 - 125	04/09→05/16				03.7858-4632.4 300273	ATE Ø 9 / 8" pneumatisch
2.0 TFSI quattro	155	04/09→05/16					
3.0 TDI quattro	176	04/09→01/12					
2.0 TDI quattro	110 - 140	05/13→05/16		+PR GP0 / GP1		03.7858-4632.4 300273	ATE Ø 9 / 8" pneumatisch
2.0 TFSI quattro	162 - 165	05/13→05/16					
3.0 TDI quattro	180	01/12→05/16					
2.0 TDI quattro	130	11/11→05/16		01/12→; +PR GP0 / GP1		03.7858-4632.4 300273	ATE Ø 9 / 8" pneumatisch
Hauptbremszylinder							
2.0 TDI quattro	100 - 125	04/09→05/16				03.2125-0493.3 010940	ATE Ø 25,4
2.0 TFSI quattro	155	04/09→05/16				24.2125-1739.3 010948	TRW Ø 25,4
3.0 TDI quattro	176	04/09→01/12					
2.0 TDI quattro	110 - 140	05/13→05/16		+PR GP0 / GP1		03.2125-0493.3 010940	ATE Ø 25,4
2.0 TFSI quattro	162 - 165	05/13→05/16		+PR GP2		24.2125-1752.3 011134	TRW Ø 25,4 ohne Bremsflüssigkeitsbehälter
→							

	kw			 	! #		
AUDI - A4 Allroad B8 (8KH) 04/09→06/17							
 Hauptbremszylinder							
2.0 TDI quattro	130	11/11→05/16		01/12→; +PR GP0 / GP1		03.2125-0493.3 010940 24.2125-1739.3 010948	ATE Ø 25,4 TRW Ø 25,4
				01/12→; +PR GP2		24.2125-1752.3 011134	TRW Ø 25,4 ohne Bremsflüssigkeitsbehälter
3.0 TDI quattro	180	01/12→05/16		+PR GP0 / GP1		03.2125-0493.3 010940 24.2125-1739.3 010948 24.2125-1752.3 011134	ATE Ø 25,4 TRW Ø 25,4 TRW Ø 25,4 ohne Bremsflüssigkeitsbehälter
AUDI - A4 B5 (8D2) 11/94→12/01							
 Hauptbremszylinder							
1.6	74	11/94→10/00		→ 01/99		24.2123-1717.3 010521	Ø 23,8
1.8	85 - 92	11/94→11/00		02/99→; - ESP; für Linkslenker		24.2125-1712.3 010622	Ø 25,4
1.8 T	132	12/97→11/00		02/99→; + ESP; für Linkslenker		24.2125-1713.3 010623	Ø 25,4
1.9 TDI	66	01/95→11/00					
2.4	120	08/97→11/00					
2.5 TDI	110	09/97→11/00					
2.6	110	01/95→11/00					
2.8	142	10/96→11/00					
1.6	75	07/00→11/00		- ESP; für Linkslenker		24.2125-1712.3 010622	Ø 25,4
1.9 TDI	85	03/00→11/00		+ ESP; für Linkslenker		24.2125-1713.3 010623	Ø 25,4
1.9 TDI quattro	85	03/00→11/00					
2.8	140	09/99→10/00					
2.8 quattro	140	09/99→10/00					
1.8 quattro	85 - 92	01/95→11/00		→ 01/99; - ESP		24.2123-1717.3 010521	Ø 23,8
				→ 01/99; + ESP		24.2123-1730.3 010620	Ø 23,8
1.8 T quattro	132	12/97→11/00		02/99→; - ESP; für Linkslenker		24.2125-1712.3 010622	Ø 25,4
1.9 TDI quattro	81	07/96→01/00		02/99→; + ESP; für Linkslenker		24.2125-1713.3 010623	Ø 25,4
2.4 quattro	120	08/97→11/00					
2.6 quattro	110	01/95→11/00					
1.8 T	110	01/95→11/00		05/95→ 01/99		24.2123-1717.3 010521	Ø 23,8
				02/99→; - ESP; für Linkslenker		24.2125-1712.3 010622	Ø 25,4
				02/99→; + ESP; für Linkslenker		24.2125-1713.3 010623	Ø 25,4
1.8 T quattro	110	01/95→11/00		02/95→ 01/99; - ESP		24.2123-1717.3 010521	Ø 23,8
				02/95→ 01/99; + ESP		24.2123-1730.3 010620	Ø 23,8
				02/99→; - ESP; für Linkslenker		24.2125-1712.3 010622	Ø 25,4
				02/99→; + ESP; für Linkslenker		24.2125-1713.3 010623	Ø 25,4
1.9 TDI	55	12/95→11/00		03/96→ 01/99		24.2123-1717.3 010521	Ø 23,8
				02/99→; - ESP; für Linkslenker		24.2125-1712.3 010622	Ø 25,4
				02/99→; + ESP; für Linkslenker		24.2125-1713.3 010623	Ø 25,4
1.9 TDI	81	10/95→11/00		02/96→ 01/99		24.2123-1717.3 010521	Ø 23,8
				02/99→; - ESP; für Linkslenker		24.2125-1712.3 010622	Ø 25,4
				02/99→; + ESP; für Linkslenker		24.2125-1713.3 010623	Ø 25,4
2.4	121	03/97→11/00		→ 07/97		24.2123-1717.3 010521	Ø 23,8
				08/97→ 01/99		24.2123-1717.3 010521	Ø 23,8
				02/99→; - ESP; für Linkslenker		24.2125-1712.3 010622	Ø 25,4
				02/99→; + ESP; für Linkslenker		24.2125-1713.3 010623	Ø 25,4
2.4 quattro	121	03/97→11/00		08/97→ 01/99; - ESP		24.2123-1717.3 010521	Ø 23,8
				08/97→ 01/99; + ESP		24.2123-1730.3 010620	Ø 23,8
				02/99→; - ESP; für Linkslenker		24.2125-1712.3 010622	Ø 25,4
				02/99→; + ESP; für Linkslenker		24.2125-1713.3 010623	Ø 25,4
2.5 TDI quattro	110	09/97→11/00		11/97→ 01/99		24.2123-1717.3 010521	Ø 23,8
				11/97→ 01/99; + ESP		24.2123-1730.3 010620	Ø 23,8
				02/99→; - ESP; für Linkslenker		24.2125-1712.3 010622	Ø 25,4
				02/99→; + ESP; für Linkslenker		24.2125-1713.3 010623	Ø 25,4
2.8 quattro	142	10/96→08/01		→ 01/99; - ESP		24.2123-1717.3 010521	Ø 23,8
				→ 01/99; + ESP		24.2123-1730.3 010620	Ø 23,8
				02/99→ 04/01; - ESP; für Linkslenker		24.2125-1712.3 010622	Ø 25,4
				02/99→ 04/01; + ESP; für Linkslenker		24.2125-1713.3 010623	Ø 25,4
S4 quattro	195	09/97→09/01		10/97→ 01/99; - ESP		24.2123-1717.3 010521	Ø 23,8
				10/97→ 01/99; + ESP		24.2123-1730.3 010620	Ø 23,8
				02/99→ 04/01; - ESP; für Linkslenker		24.2125-1712.3 010622	Ø 25,4
				02/99→ 04/01; + ESP; für Linkslenker		24.2125-1713.3 010623	Ø 25,4

AUDI - A4 B5 Avant (8D5) 11/94→12/02

Hauptbremszylinder

1.6	74	11/94→09/01		→ 01/99	24.2123-1717.3	010521	Ø 23,8
1.8	85 - 92	07/95→09/01		02/99→ 04/01; - ESP; für Linkslenker	24.2125-1712.3	010622	Ø 25,4
1.8 T	110 - 132	03/96→09/01		02/99→ 04/01; + ESP; für Linkslenker	24.2125-1713.3	010623	Ø 25,4
1.9 TDI	66 - 81	02/96→09/01					
2.4	120	08/97→09/01					
2.5 TDI	110	09/97→09/01					
2.6	110	02/96→09/01					
2.8	142	10/96→09/01					
1.6	75	07/00→09/01		→ 04/01; - ESP; für Linkslenker	24.2125-1712.3	010622	Ø 25,4
1.9 TDI	85	03/00→09/01		→ 04/01; + ESP; für Linkslenker	24.2125-1713.3	010623	Ø 25,4
1.9 TDI quattro	85	03/00→09/01					
1.8 quattro	85 - 92	07/95→09/01		→ 01/99; - ESP	24.2123-1717.3	010521	Ø 23,8
1.8 T quattro	110 - 132	01/96→09/01		→ 01/99; + ESP	24.2123-1730.3	010620	Ø 23,8
				02/99→ 04/01; - ESP; für Linkslenker	24.2125-1712.3	010622	Ø 25,4
1.9 TDI quattro	81	09/96→09/01		02/99→ 04/01; + ESP; für Linkslenker	24.2125-1713.3	010623	Ø 25,4
2.4 quattro	120	08/97→09/01					
2.6 quattro	110	01/96→09/01					
2.8 quattro	142	10/96→09/01					
1.9 Hybrid	66	03/98→06/00		→ 01/99	24.2123-1717.3	010521	Ø 23,8
				02/99→; - ESP; für Linkslenker	24.2125-1712.3	010622	Ø 25,4
				02/99→; + ESP; für Linkslenker	24.2125-1713.3	010623	Ø 25,4
2.4	121	03/97→09/01		08/97→ 01/99	24.2123-1717.3	010521	Ø 23,8
				02/99→ 04/01; - ESP; für Linkslenker	24.2125-1712.3	010622	Ø 25,4
				02/99→ 04/01; + ESP; für Linkslenker	24.2125-1713.3	010623	Ø 25,4
2.4 quattro	121	03/97→09/01		08/97→ 01/99; - ESP	24.2123-1717.3	010521	Ø 23,8
				08/97→ 01/99; + ESP	24.2123-1730.3	010620	Ø 23,8
				02/99→ 04/01; - ESP; für Linkslenker	24.2125-1712.3	010622	Ø 25,4
				02/99→ 04/01; + ESP; für Linkslenker	24.2125-1713.3	010623	Ø 25,4
2.5 TDI quattro	110	09/97→09/01		11/97→ 01/99	24.2123-1717.3	010521	Ø 23,8
				11/97→ 01/99; + ESP	24.2123-1730.3	010620	Ø 23,8
				02/99→ 04/01; - ESP; für Linkslenker	24.2125-1712.3	010622	Ø 25,4
				02/99→ 04/01; + ESP; für Linkslenker	24.2125-1713.3	010623	Ø 25,4
2.8	140	03/99→09/00		- ESP; für Linkslenker	24.2125-1712.3	010622	Ø 25,4
2.8 quattro	140	03/99→09/00		+ ESP; für Linkslenker	24.2125-1713.3	010623	Ø 25,4
RS4 quattro	280	05/00→09/01		06/00→ 04/01; für Linkslenker	24.2125-1713.3	010623	Ø 25,4
S4 quattro	195	09/97→09/01		10/97→ 01/99; - ESP	24.2123-1717.3	010521	Ø 23,8
				10/97→ 01/99; + ESP	24.2123-1730.3	010620	Ø 23,8
				02/99→ 04/01; - ESP; für Linkslenker	24.2125-1712.3	010622	Ø 25,4
				02/99→ 04/01; + ESP; für Linkslenker	24.2125-1713.3	010623	Ø 25,4











AUDI - A4 B6 (8E2) 11/00→12/05











Bremskraftverstärker











1.6	75	11/00→12/04		8E-3-235001→	03.7858-4502.4	300202	ATE Ø 9 / 8" pneumatisch
1.8 T	110 - 140	11/00→12/04					
1.8 T quattro	110 - 140	11/00→12/04					
1.9 TDI	74 - 96	11/00→12/04					
1.9 TDI quattro	96	11/01→12/04					
2.0	96	11/00→12/04					
2.0 FSI	110	07/02→12/04					
2.4	120 - 125	09/01→12/04					
2.5 TDI	114 - 120	08/01→12/04					
2.5 TDI quattro	132	11/00→12/04					
3.0	160 - 162	11/00→12/04					
3.0 quattro	160 - 162	11/00→12/04					
1.9 TDI	85	06/04→12/04			03.7858-4502.4	300202	ATE Ø 9 / 8" pneumatisch











Hauptbremszylinder











1.6	75	11/00→12/04		12/00→	03.2125-0373.3	010810	ATE Ø 25,4
1.8 T	110	11/00→07/02			24.2125-1720.3	010688	TRW Ø 25,4
1.8 T quattro	110	11/00→07/02					
1.9 TDI	96	11/00→12/04					
2.0	96	11/00→12/04					
→							











	kW			 	! #		
AUDI - A4 B6 (8E2) 11/00→12/05							
 Hauptbremszylinder							
2.5 TDI quattro 3.0 3.0 quattro	132 162 162	11/00→12/04 11/00→12/04 11/00→12/04		12/00→		03.2125-0373.3 010810 24.2125-1720.3 010688	ATE Ø 25,4 TRW Ø 25,4
1.8 T 1.8 T quattro 1.9 TDI 1.9 TDI quattro 2.0 FSI 2.4 2.5 TDI 3.0 3.0 quattro S4 quattro	120 - 140 120 - 140 74 - 85 96 110 120 - 125 114 - 120 160 160 253	07/01→12/04 07/01→12/04 05/01→12/04 11/01→12/04 07/02→12/04 09/01→12/04 08/01→12/04 04/01→12/04 04/01→12/04 03/03→12/04				03.2125-0373.3 010810 24.2125-1720.3 010688	ATE Ø 25,4 TRW Ø 25,4
AUDI - A4 B6 Avant (8E5) 02/00→12/05							
 Bremskraftverstärker							
1.6 1.8 T 1.8 T quattro 1.9 TDI 1.9 TDI quattro 2.0 2.0 FSI 2.4 2.5 TDI 2.5 TDI quattro 3.0 3.0 quattro 1.9 TDI	75 110 - 140 110 - 140 74 - 96 96 96 110 120 - 125 114 - 120 132 160 - 162 160 - 162 85	09/01→12/04 09/01→12/04 09/01→12/04 09/01→12/04 11/01→12/04 09/01→12/04 07/02→12/04 09/01→12/04 09/01→12/04 09/01→12/04 04/01→12/04 04/01→12/04 06/04→12/04		8E-3-235001→		03.7858-4502.4 300202 03.7858-4502.4 300202	ATE Ø 9 / 8" pneumatisch ATE Ø 9 / 8" pneumatisch
 Hauptbremszylinder							
1.6 1.8 T 1.8 T quattro 1.9 TDI 1.9 TDI quattro 2.0 2.0 FSI 2.4 2.5 TDI 2.5 TDI quattro 3.0 3.0 quattro S4 quattro	75 110 - 140 110 - 140 74 - 96 96 96 110 120 - 125 114 - 120 132 160 - 162 160 - 162 253	09/01→12/04 09/01→12/04 09/01→12/04 09/01→12/04 11/01→12/04 09/01→12/04 07/02→12/04 09/01→12/04 09/01→12/04 09/01→12/04 04/01→12/04 04/01→12/04 03/03→12/04				03.2125-0373.3 010810 24.2125-1720.3 010688	ATE Ø 25,4 TRW Ø 25,4
AUDI - A4 B6 Cabriolet (8H7) 01/02→12/09							
 Bremskraftverstärker							
1.8 T 2.4 2.5 TDI 3.0 1.8 T quattro 2.0 3.0 quattro 3.0 →	120 - 125 120 - 125 120 162 120 96 162 160	07/02→12/05 04/02→12/05 08/02→12/05 04/02→12/05 05/03→12/05 09/04→12/05 05/03→12/05 04/02→12/05		8H-3-017415→ 8E-3-235001→		03.7858-4502.4 300202 03.7858-4502.4 300202 03.7858-4502.4 300202	ATE Ø 9 / 8" pneumatisch ATE Ø 9 / 8" pneumatisch ATE Ø 9 / 8" pneumatisch













	kw			 	! #		
AUDI - A4 B6 Cabriolet (8H7) 01/02→12/09							
 Hauptbremszylinder							
1.8 T	120 - 125	07/02→12/05		8H-7-022001→		03.2125-0373.3 010810	ATE Ø 25,4
2.4	120 - 125	04/02→12/05		8H-3-017415→ 8H-7-022000		03.2125-0373.3 010810	ATE Ø 25,4
2.5 TDI 3.0	120 162	08/02→12/05 04/02→12/05				24.2125-1720.3 010688	TRW Ø 25,4
1.8 T quattro 2.0 3.0 quattro	120 96 162	05/03→12/05 09/04→12/05 05/03→12/05		8H-7-022001→ → 8H-7-022000		03.2125-0373.3 010810	ATE Ø 25,4
3.0	160	04/02→12/05				24.2125-1720.3 010688	TRW Ø 25,4
S4 quattro	253	03/04→12/05				24.2126-1705.3 010999	TRW Ø 27
AUDI - A4 B7 (8EC) 11/04→01/09							
 Bremskraftverstärker							
1.6 1.8 T 1.8 T quattro 2.0 2.5 TDI 3.0 3.0 quattro	75 120 120 96 120 160 160	11/04→06/08 11/04→06/08 11/04→06/08 11/04→06/08 11/04→05/06 11/04→05/06 11/04→07/06		8E-3-235001→		03.7858-4502.4 300202	ATE Ø 9 / 8" pneumatisch
1.9 TDI 2.0 TDI 2.0 TDI quattro 2.0 TFSI 2.7 TDI 3.0 TDI quattro 3.2 FSI	85 120 - 125 103 - 125 125 - 162 120 - 132 171 188	11/04→06/08 06/06→06/08 01/06→06/08 11/04→06/08 11/05→06/08 01/06→06/08 01/05→06/08				03.7858-4502.4 300202	ATE Ø 9 / 8" pneumatisch
2.0 TDI 2.0 TDI 16V 2.0 TFSI quattro 3.0 TDI quattro 3.2 FSI quattro 2.0 TDI	89 - 103 103 147 - 162 150 188 93	11/04→06/08 11/04→06/08 11/04→06/08 11/04→06/08 01/05→06/08 11/05→11/06		8E-5-400001→ 06/06→		03.7858-4502.4 300202	ATE Ø 9 / 8" pneumatisch
 Hauptbremszylinder							
1.6 1.8 T 1.8 T quattro 1.9 TDI 2.0 2.0 TDI 2.0 TDI 16V 2.0 TDI quattro 2.0 TFSI 2.0 TFSI quattro 2.5 TDI 2.7 TDI 3.0 3.0 quattro 3.0 TDI quattro 3.2 FSI 3.2 FSI quattro 2.0 TDI 2.0 TFSI RS4 quattro S4 quattro	75 120 120 85 96 89 - 125 103 103 - 125 125 - 162 147 - 162 120 120 - 132 160 160 150 - 171 188 188 93 147 309 253	11/04→06/08 11/04→06/08 11/04→06/08 11/04→06/08 11/04→06/08 11/04→06/08 11/04→06/08 01/06→06/08 06/05→06/08 11/04→06/08 11/04→05/06 11/05→06/08 11/04→05/06 11/04→07/06 11/04→06/08 01/05→06/08 01/05→06/08 11/05→11/06 11/04→06/08 09/05→06/08 11/04→06/08				03.2125-0373.3 010810 24.2125-1720.3 010688 03.2125-0373.3 010810 24.2125-1720.3 010688 24.2126-1705.3 010999 24.2126-1705.3 010999	ATE Ø 25,4 TRW Ø 25,4 ATE Ø 25,4 TRW Ø 25,4 TRW Ø 27 TRW Ø 27

	kw			 	! #		
AUDI - A4 B7 Avant (8ED) 11/04→11/08							
 Bremskraftverstärker							
1.6	75	11/04→06/08		8E-3-235001→		03.7858-4502.4 300202	ATE Ø 9 / 8" pneumatisch
1.8 T	120	11/04→06/08					
1.8 T quattro	120	11/04→06/08					
2.0	96	11/04→06/08					
2.5 TDI	120	11/04→05/06					
3.0	160	11/04→05/06					
3.0 quattro	160	11/04→07/06					
1.9 TDI	85	11/04→06/08				03.7858-4502.4 300202	ATE Ø 9 / 8" pneumatisch
2.0 TDI	120 - 125	06/06→06/08					
2.0 TDI quattro	103 - 125	01/06→06/08					
2.0 TFSI	125 - 162	11/04→06/08					
2.7 TDi	120	11/05→03/08					
2.7 TDI	132	01/06→06/08					
3.0 TDI quattro	171	01/06→06/08					
3.2 FSI	188	01/05→06/08					
2.0 TDI	89 - 103	11/04→06/08		8E-5-400001→		03.7858-4502.4 300202	ATE Ø 9 / 8" pneumatisch
2.0 TDI 16V	103	11/04→06/08					
2.0 TFSI quattro	147 - 162	11/04→06/08					
3.0 TDI quattro	150	11/04→06/08					
3.2 FSI quattro	188	01/05→06/08					
2.0 TDI	93	11/05→11/06		06/06→		03.7858-4502.4 300202	ATE Ø 9 / 8" pneumatisch
 Hauptbremszylinder							
1.6	75	11/04→06/08				03.2125-0373.3 010810	ATE Ø 25,4
1.8 T	120	11/04→06/08				24.2125-1720.3 010688	TRW Ø 25,4
1.8 T quattro	120	11/04→06/08					
1.9 TDI	85	11/04→06/08					
2.0	96	11/04→06/08					
2.0 TDI	89 - 125	11/04→06/08					
2.0 TDI 16V	103	11/04→06/08					
2.0 TDI quattro	103 - 125	01/06→06/08					
2.0 TFSI	125 - 162	06/05→06/08					
2.0 TFSI quattro	147 - 162	11/04→06/08					
2.5 TDI	120	11/04→05/06					
2.7 TDi	120	11/05→03/08					
2.7 TDI	132	01/06→06/08					
3.0	160	11/04→05/06					
3.0 quattro	160	11/04→07/06					
3.0 TDI quattro	150 - 171	11/04→06/08					
3.2 FSI	188	01/05→06/08					
3.2 FSI quattro	188	01/05→06/08					
2.0 TDI	93	11/05→11/06		06/06→		03.2125-0373.3 010810	ATE Ø 25,4
						24.2125-1720.3 010688	TRW Ø 25,4
2.0 TFSI	147	11/04→06/08		12/04→		03.2125-0373.3 010810	ATE Ø 25,4
						24.2125-1720.3 010688	TRW Ø 25,4
RS4 quattro	309	09/05→06/08		11/05→		24.2126-1705.3 010999	TRW Ø 27
S4 quattro	253	11/04→06/08				24.2126-1705.3 010999	TRW Ø 27
AUDI - A4 B7 Cabriolet (8HE) 01/02→01/10							
 Bremskraftverstärker							
1.8 T	120	01/06→03/09		8E-3-235001→		03.7858-4502.4 300202	ATE Ø 9 / 8" pneumatisch
2.0 TDI	100 - 103	01/06→03/09		→ 11/08		03.7858-4502.4 300202	ATE Ø 9 / 8" pneumatisch
2.0 TFSI 16V	147	01/06→03/09					
2.7 TDI	132	06/06→03/09					
3.0 TDI quattro	150 - 171	01/06→03/09					
3.2 FSI	188	01/06→03/09					
3.2 FSI quattro	188	01/06→03/09					
 Hauptbremszylinder							
1.8 T	120	01/06→03/09				03.2125-0373.3 010810	ATE Ø 25,4
						24.2125-1720.3 010688	TRW Ø 25,4
2.0 TDI	100 - 103	01/06→03/09		→ 8H-7-022000		03.2125-0373.3 010810	ATE Ø 25,4
2.0 TFSI 16V	147	01/06→03/09		8H-7-022001→; → 11/08		03.2125-0373.3 010810	ATE Ø 25,4
2.7 TDI	132	06/06→03/09		→ 11/08		24.2125-1720.3 010688	TRW Ø 25,4
→							

	kw			 	! #		
AUDI - A4 B7 Cabriolet (8HE) 01/02→01/10							
 Hauptbremszylinder							
3.0 TDI quattro	150 - 171	01/06→03/09		→ 8H-7-022000		03.2125-0373.3 010810	ATE Ø 25,4
3.2 FSI	188	01/06→03/09		8H-7-022001→; → 11/08		03.2125-0373.3 010810	ATE Ø 25,4
3.2 FSI quattro	188	01/06→03/09		→ 11/08		24.2125-1720.3 010688	TRW Ø 25,4
RS4 quattro	309	02/06→12/08		→ 11/08		24.2126-1705.3 010999	TRW Ø 27
S4 quattro	253	11/05→03/09				24.2126-1705.3 010999	TRW Ø 27
AUDI - A4 B8 (8K2) 08/07→06/17							
 Bremskraftverstärker							
1.8 TFSI	88 - 118	11/07→12/15				03.7858-4632.4 300273	ATE Ø 9 / 8" pneumatisch
1.8 TFSI quattro	118	09/08→03/12					
2.0 TDI	88 - 125	11/07→12/15					
2.0 TDI quattro	105 - 125	01/08→12/15					
2.0 TFSI	132 - 155	06/08→12/15					
2.0 TFSI flexible fuel	132	11/09→12/15					
2.0 TFSI flexible fuel quattro	132	11/09→12/15					
2.0 TFSI quattro	132 - 155	06/08→12/15					
2.7 TDI	120 - 140	11/07→03/12					
3.0 TDI quattro	155 - 176	11/07→03/12					
3.2 FSI	195	09/08→03/12					
3.2 FSI quattro	195	11/07→03/12					
S4 quattro	245	11/08→12/15					
 Hauptbremszylinder							
1.8 TFSI	88 - 118	11/07→12/15				03.2125-0493.3 010940	ATE Ø 25,4
1.8 TFSI quattro	118	09/08→03/12				24.2125-1739.3 010948	TRW Ø 25,4
2.0 TDI	88 - 125	11/07→12/15					
2.0 TDI quattro	105 - 125	01/08→12/15					
2.0 TFSI	132 - 155	06/08→12/15					
2.0 TFSI flexible fuel	132	11/09→12/15					
2.0 TFSI flexible fuel quattro	132	11/09→12/15					
2.0 TFSI quattro	132 - 155	06/08→12/15					
2.7 TDI	120 - 140	11/07→03/12					
3.0 TDI quattro	155 - 176	11/07→03/12					
3.2 FSI	195	09/08→03/12					
3.2 FSI quattro	195	11/07→03/12					
S4 quattro	245	11/08→12/15					
1.8 TFSI	125	11/11→12/15		01/12→		24.2125-1752.3 011134	TRW Ø 25,4 ohne Bremsflüssigkeitsbehälter
1.8 TFSI quattro	125	11/11→12/15					
2.0 TDI	110 - 140	11/11→12/15				24.2125-1752.3 011134	TRW Ø 25,4 ohne Bremsflüssigkeitsbehälter
2.0 TDI quattro	110 - 140	11/11→12/15					
2.0 TFSI	162 - 165	05/13→12/15					
2.0 TFSI quattro	162 - 165	05/13→12/15					
3.0 TDI	150	11/11→12/15					
3.0 TDI quattro	180	11/11→12/15					
3.0 TFSI quattro	200	02/12→12/15					
AUDI - A4 B8 Avant (8K5) 11/07→06/17							
 Bremskraftverstärker							
1.8 TFSI	88	04/08→12/15				03.7858-4632.4 300273	ATE Ø 9 / 8" pneumatisch
1.8 TFSI quattro	118	09/08→03/12					
2.0 TDI	88 - 125	04/08→12/15					
2.0 TDI quattro	105 - 125	04/08→12/15					
2.0 TFSI	132 - 155	06/08→12/15					
2.0 TFSI flexible fuel	132	11/09→12/15					
→							

	kW					! #		
AUDI - A4 B8 Avant (8K5) 11/07→06/17								
 Bremskraftverstärker								
2.0 TFSI flexible fuel quattro	132	11/09→12/15					03.7858-4632.4 300273	ATE Ø 9 / 8" pneumatisch
2.0 TFSI quattro	155	06/08→12/15						
2.7 TDI	120	06/08→03/12						
3.0 TDI quattro	155 - 176	04/08→03/12						
3.2 FSI	195	09/08→03/12						
3.2 FSI quattro	195	04/08→03/12						
S4 quattro	245	11/08→12/15						
1.8 TFSI	118	11/07→03/12		04/08→			03.7858-4632.4 300273	ATE Ø 9 / 8" pneumatisch
2.7 TDI	140	04/08→03/12		06/08→			03.7858-4632.4 300273	ATE Ø 9 / 8" pneumatisch
 Hauptbremszylinder								
1.8 TFSI	88	04/08→12/15					03.2125-0493.3 010940	ATE Ø 25,4
1.8 TFSI quattro	118	09/08→03/12					24.2125-1739.3 010948	TRW Ø 25,4
2.0 TDI	88 - 125	04/08→12/15						
2.0 TDI quattro	105 - 125	04/08→12/15						
2.0 TFSI	132 - 155	06/08→12/15						
2.0 TFSI flexible fuel	132	11/09→12/15						
2.0 TFSI flexible fuel quattro	132	11/09→12/15						
2.0 TFSI quattro	155	06/08→12/15						
2.7 TDI	120	06/08→03/12						
3.0 TDI quattro	155 - 176	04/08→03/12						
3.2 FSI	195	09/08→03/12						
3.2 FSI quattro	195	04/08→03/12						
S4 quattro	245	11/08→12/15						
1.8 TFSI	118	11/07→03/12		04/08→			03.2125-0493.3 010940	ATE Ø 25,4
							24.2125-1739.3 010948	TRW Ø 25,4
1.8 TFSI	125	11/11→12/15		01/12→			24.2125-1752.3 011134	TRW Ø 25,4 ohne Bremsflüssigkeitsbehälter
1.8 TFSI quattro	125	11/11→12/15						
2.0 TDI	110 - 140	11/11→12/15					24.2125-1752.3 011134	TRW Ø 25,4 ohne Bremsflüssigkeitsbehälter
2.0 TDI quattro	110 - 140	11/11→12/15						
2.0 TFSI	165	05/13→12/15						
2.0 TFSI quattro	165	05/13→12/15						
3.0 TDI	150	11/11→12/15						
3.0 TDI quattro	180	11/11→12/15						
3.0 TFSI quattro	200	02/12→12/15						
2.7 TDI	140	04/08→03/12		06/08→			03.2125-0493.3 010940	ATE Ø 25,4
							24.2125-1739.3 010948	TRW Ø 25,4
AUDI - A5 (8T3) 06/07→10/17								
 Bremskraftverstärker								
1.8 TFSI	118 - 125	10/07→01/17					03.7858-4632.4 300273	ATE Ø 9 / 8" pneumatisch
2.0 TDI	125 - 130	08/08→01/17						
2.0 TDI quattro	125	08/08→03/12						
2.0 TFSI	132 - 155	06/08→11/13						
2.0 TFSI quattro	155	06/08→01/17						
2.7 TDI	120 - 140	06/07→03/12						
3.0 TDI	150	10/11→01/17						
3.0 TDI quattro	155 - 180	06/07→01/17						
3.2 FSI	195	06/07→03/12						
3.2 FSI quattro	195	06/07→03/12						
S5 quattro	245 - 260	06/07→01/17						
2.0 TDI	120	08/08→01/17		10/08→			03.7858-4632.4 300273	ATE Ø 9 / 8" pneumatisch
 Hauptbremszylinder								
1.8 TFSI	118 - 125	10/07→01/17					03.2125-0493.3 010940	ATE Ø 25,4
2.0 TDI	125 - 130	08/08→01/17					24.2125-1739.3 010948	TRW Ø 25,4
2.0 TDI quattro	125	08/08→03/12						
2.0 TFSI	132 - 155	06/08→11/13						
2.0 TFSI quattro	155	06/08→01/17						
→								

	kw			 	! #		
AUDI - A5 (8T3) 06/07→10/17							
 Hauptbremszylinder							
2.7 TDI	120 - 140	06/07→03/12				03.2125-0493.3 010940	ATE Ø 25,4
3.0 TDI	150	10/11→01/17				24.2125-1739.3 010948	TRW Ø 25,4
3.0 TDI quattro	155 - 180	06/07→01/17					
3.2 FSI	195	06/07→03/12					
3.2 FSI quattro	195	06/07→03/12					
S5 quattro	245 - 260	06/07→01/17					
1.8 TFSI	130	05/15→01/17				24.2125-1752.3 011134	TRW Ø 25,4 ohne Bremsflüssigkeitsbehälter
2.0 TDI	140	09/13→01/17					
2.0 TDI quattro	140	09/13→01/17					
2.0 TFSI	165 - 169	05/13→01/17					
2.0 TFSI quattro	165	05/13→05/16					
3.0 TDI quattro	160	05/15→01/17					
2.0 TDI	120	08/08→01/17		10/08→		03.2125-0493.3 010940	ATE Ø 25,4
						24.2125-1739.3 010948	TRW Ø 25,4
2.0 TDI quattro	130	12/11→01/17		12/11→		24.2125-1752.3 011134	TRW Ø 25,4 ohne Bremsflüssigkeitsbehälter
3.0 TFSI quattro	200	12/11→01/17					
2.0 TFSI quattro	162	03/12→01/17		05/13→		24.2125-1752.3 011134	TRW Ø 25,4 ohne Bremsflüssigkeitsbehälter
2.0 TFSI quattro	169	08/15→01/17		08/15→		24.2125-1752.3 011134	TRW Ø 25,4 ohne Bremsflüssigkeitsbehälter
AUDI - A5 Cabriolet (8F7) 02/09→10/17							
 Bremskraftverstärker							
1.8 TFSI	118 - 125	09/09→03/16				03.7858-4632.4 300273	ATE Ø 9 / 8" pneumatisch
2.0 TDI	120 - 130	05/09→01/17					
2.0 TFSI	132	03/09→03/12					
2.0 TFSI quattro	155	03/09→01/17					
2.7 TDI	120 - 140	03/09→03/12					
3.0 TDI	150	10/11→01/17					
3.0 TDI quattro	176 - 180	03/09→01/17					
3.2 FSI	195	03/09→03/12					
3.2 FSI quattro	195	03/09→03/12					
S5 quattro	245	06/09→01/17					
2.0 TFSI	155	03/09→06/14		+PR 1LT		03.7858-4632.4 300273	ATE Ø 9 / 8" pneumatisch
 Hauptbremszylinder							
1.8 TFSI	118 - 125	09/09→03/16				03.2125-0493.3 010940	ATE Ø 25,4
2.0 TDI	120 - 130	05/09→01/17				24.2125-1739.3 010948	TRW Ø 25,4
2.0 TFSI	132	03/09→03/12					
2.0 TFSI quattro	155	03/09→01/17					
2.7 TDI	120 - 140	03/09→03/12					
3.0 TDI	150	10/11→01/17					
3.0 TDI quattro	176 - 180	03/09→01/17					
3.2 FSI	195	03/09→03/12					
3.2 FSI quattro	195	03/09→03/12					
S5 quattro	245	06/09→01/17					
1.8 TFSI	130	05/15→01/17		05/15→		24.2125-1752.3 011134	TRW Ø 25,4 ohne Bremsflüssigkeitsbehälter
2.0 TDI	105	10/11→05/15		11/11→		24.2125-1752.3 011134	TRW Ø 25,4 ohne Bremsflüssigkeitsbehälter
3.0 TFSI quattro	200	11/11→01/17					
2.0 TDI	110 - 140	05/13→01/17				24.2125-1752.3 011134	TRW Ø 25,4 ohne Bremsflüssigkeitsbehälter
2.0 TDI quattro	140	09/13→01/17					
2.0 TFSI	162 - 169	05/13→01/17					
2.0 TFSI quattro	165	05/13→05/16					
3.0 TDI quattro	160	05/15→01/17					
2.0 TDI quattro	130	01/12→05/15		01/12→		24.2125-1752.3 011134	TRW Ø 25,4 ohne Bremsflüssigkeitsbehälter
2.0 TFSI	155	03/09→06/14		+PR 1LT		03.2125-0493.3 010940	ATE Ø 25,4
						24.2125-1739.3 010948	TRW Ø 25,4
2.0 TFSI quattro	162	03/12→01/17		05/13→		24.2125-1752.3 011134	TRW Ø 25,4 ohne Bremsflüssigkeitsbehälter
2.0 TFSI quattro	169	08/15→01/17		08/15→		24.2125-1752.3 011134	TRW Ø 25,4 ohne Bremsflüssigkeitsbehälter

	kw			 	! #		
AUDI - A5 Sportback (8TA) 07/07→10/17							
 Bremskraftverstärker							
1.8 TFSI	118 - 125	11/09→01/17				03.7858-4632.4 300273	ATE Ø 9 / 8" pneumatisch
2.0 TDI	100 - 130	09/09→01/17					
2.0 TDI quattro	125	09/09→03/12					
2.0 TFSI	132 - 155	09/09→06/14					
2.0 TFSI quattro	155	09/09→01/17					
2.7 TDI	120 - 140	09/09→03/12					
3.0 TDI	150	10/11→01/17					
3.0 TDI quattro	176 - 180	09/09→01/17					
3.2 FSI quattro	195	09/09→03/12					
S5 quattro	245	01/10→01/17					
 Hauptbremszylinder							
1.8 TFSI	106 - 130	09/14→01/17				24.2125-1752.3 011134	TRW Ø 25,4 ohne Bremsflüssigkeitsbehälter
2.0 TDI	110 - 140	05/13→01/17					
2.0 TDI quattro	140	09/13→01/17					
2.0 TFSI	165 - 169	05/13→01/17					
2.0 TFSI quattro	165	05/13→05/16					
3.0 TDI quattro	160	05/15→01/17					
3.0 TFSI quattro	200	12/11→01/17					
1.8 TFSI	118 - 125	11/09→01/17				03.2125-0493.3 010940	ATE Ø 25,4
2.0 TDI	100 - 130	09/09→01/17				24.2125-1739.3 010948	TRW Ø 25,4
2.0 TDI quattro	125	09/09→03/12					
2.0 TFSI	132 - 155	09/09→06/14					
2.0 TFSI quattro	155	09/09→01/17					
2.7 TDI	120 - 140	09/09→03/12					
3.0 TDI	150	10/11→01/17					
3.0 TDI quattro	176 - 180	09/09→01/17					
3.2 FSI quattro	195	09/09→03/12					
S5 quattro	245	01/10→01/17					
2.0 TDI quattro	130	12/11→01/17		12/11→		24.2125-1752.3 011134	TRW Ø 25,4 ohne Bremsflüssigkeitsbehälter
2.0 TFSI quattro	169	08/15→01/17		08/15→		24.2125-1752.3 011134	TRW Ø 25,4 ohne Bremsflüssigkeitsbehälter
AUDI - A6 Allroad C6 (4FH) 03/06→08/11							
 Hauptbremszylinder							
2.7 TDI quattro	120 - 140	05/06→08/11		→ 05/11		24.2126-1705.3 010999	TRW Ø 27
3.0 TDI quattro	155 - 176	05/06→08/11					
3.0 TFSI quattro	213	10/08→08/11					
2.7 TDI quattro	132	03/06→10/08				24.2126-1705.3 010999	TRW Ø 27
3.0 TDI quattro	171	05/06→10/08					
3.2 FSI quattro	188	05/06→10/08					
4.2 FSI quattro	257	05/06→12/10					
AUDI - A6 Allroad C7 (4GH, 4GJ) 01/12→09/18							
 Hauptbremszylinder							
3.0 TDI quattro	140 - 235	01/12→09/18		für Linkslenker		24.2125-1749.3 011031	TRW Ø 25,4
3.0 TFSI quattro	228 - 245	01/12→09/18		für Rechtslenker		24.2125-1752.3 011134	TRW Ø 25,4 ohne Bremsflüssigkeitsbehälter
AUDI - A6 C5 (4B2, 4B4) 01/97→12/05							
 Bremskraftverstärker							
1.8	85 - 92	05/97→01/05		4B-2-130001→		03.7858-4502.4 300202	ATE Ø 9 / 8" pneumatisch
1.8 T	110 - 132	01/97→01/05					
1.8 T quattro	110 - 132	02/97→01/05					
1.9 TDI	81 - 96	04/97→01/05					
2.0	96	08/01→01/05					
→							

AUDI - A6 C5 (4B2, 4B4) 01/97→12/05

Bremskraftverstärker

2.4	100 - 125	02/97→01/05		4B-2-130001→			ATE Ø 9 / 8" pneumatisch
2.4 quattro	120 - 125	02/97→01/05					
2.5 TDI	110 - 132	07/97→01/05					
2.5 TDI quattro	110 - 132	07/97→01/05					
2.7 quattro	187	05/01→07/04					
2.7 T	169	02/99→01/05					
2.7 T quattro	169 - 184	12/97→01/05					
2.8	132 - 142	02/97→01/05					
2.8 quattro	132 - 142	02/97→01/05					
3.0	160 - 162	06/01→01/05					
3.0 quattro	160 - 162	06/01→01/05					
3.7	191	03/99→01/05					
3.7 quattro	191	03/99→01/05					
4.2 quattro	220	11/98→01/05					
S6 quattro	250	09/99→01/05					

Hauptbremszylinder

1.8	85 - 92	05/97→01/05		4B-2-130136→			ATE Ø 25,4
1.8 T	132	12/97→01/05		→ 4B-X-130000; + EDS	03.2125-0373.3	010810	Ø 23,8
1.8 T quattro	132	12/97→01/05		→ 4B-X-130000; + ESP	24.2123-1717.3	010521	Ø 23,8
1.9 TDI	85	07/00→01/05			24.2123-1730.3	010620	Ø 23,8
2.4	100	07/98→01/05		4B-X-130001→; → 05/01; für Linkslenker; + EDS	24.2125-1712.3	010622	Ø 25,4
2.5 TDI	110	07/97→01/05					
2.5 TDI quattro	110 - 132	07/97→01/05		4B-X-130001→; → 05/01; für Linkslenker; + ESP	24.2125-1713.3	010623	Ø 25,4
2.8	140	07/99→01/05		06/01→	24.2125-1720.3	010688	TRW Ø 25,4
1.8 T	110	01/97→01/05		4B-2-130136→	03.2125-0373.3	010810	ATE Ø 25,4
1.8 T quattro	110	02/97→01/05					
2.4	115 - 121	02/97→01/05		04/97→; → 4B-X-130000; + EDS	24.2123-1717.3	010521	Ø 23,8
				04/97→; → 4B-X-130000; + ESP	24.2123-1730.3	010620	Ø 23,8
2.4 quattro	120 - 121	02/97→01/05		4B-X-130001→; → 05/01; für Linkslenker; + EDS	24.2125-1712.3	010622	Ø 25,4
2.8	142	02/97→01/05					
2.8 quattro	142	02/97→01/05		4B-X-130001→; → 05/01; für Linkslenker; + ESP	24.2125-1713.3	010623	Ø 25,4
				06/01→	24.2125-1720.3	010688	TRW Ø 25,4
1.9 TDI	81	04/97→10/00		4B-2-130136→	03.2125-0373.3	010810	ATE Ø 25,4
2.8	132	10/97→05/00					
2.8 quattro	132 - 140	01/98→05/01		→ 4B-X-130000; + EDS	24.2123-1717.3	010521	Ø 23,8
				→ 4B-X-130000; + ESP	24.2123-1730.3	010620	Ø 23,8
				4B-X-130001→; für Linkslenker; + EDS	24.2125-1712.3	010622	Ø 25,4
				4B-X-130001→; für Linkslenker; + ESP	24.2125-1713.3	010623	Ø 25,4
1.9 TDI	96	08/01→01/05		4B-2-130136→	03.2125-0373.3	010810	ATE Ø 25,4
2.4	125	08/01→01/05					
2.4 quattro	125	08/01→01/05		→ 4B-X-130000; + EDS	24.2123-1717.3	010521	Ø 23,8
2.5 TDI	114	08/01→01/05		→ 4B-X-130000; + ESP	24.2123-1730.3	010620	Ø 23,8
2.7 T quattro	184	08/01→01/05			24.2125-1720.3	010688	TRW Ø 25,4
2.0	96	08/01→01/05		4B-2-130136→	03.2125-0373.3	010810	ATE Ø 25,4
2.5 TDI	120	07/02→01/05					
3.0	160 - 162	06/01→01/05			24.2125-1720.3	010688	TRW Ø 25,4
3.0 quattro	160 - 162	06/01→01/05					
3.7	191	03/99→01/05					
3.7 quattro	191	03/99→01/05					
2.5 TDI	132	02/00→01/05		4B-2-130136→	03.2125-0373.3	010810	ATE Ø 25,4
2.7 T	169	02/99→01/05		→ 05/01; für Linkslenker; + EDS	24.2125-1712.3	010622	Ø 25,4
				→ 05/01; für Linkslenker; + ESP	24.2125-1713.3	010623	Ø 25,4
				06/01→	24.2125-1720.3	010688	TRW Ø 25,4
2.7 quattro	187	05/01→07/04		4B-2-130136→	03.2125-0373.3	010810	ATE Ø 25,4
2.7 T quattro	169	12/97→01/05		→ 4B-X-130000; + EDS	24.2123-1717.3	010521	Ø 23,8
				→ 4B-X-130000; + ESP	24.2123-1730.3	010620	Ø 23,8
				→ 05/01; für Linkslenker; + EDS	24.2125-1712.3	010622	Ø 25,4
				4B-X-130001→; → 05/01; für Linkslenker; + ESP	24.2125-1713.3	010623	Ø 25,4
				06/01→	24.2125-1720.3	010688	TRW Ø 25,4
4.2 quattro	220	11/98→01/05		4B-2-130136→	03.2125-0373.3	010810	ATE Ø 25,4
→							

AUDI - A6 C5 (4B2, 4B4) 01/97→12/05

Hauptbremszylinder

4.2 quattro	220	11/98→01/05	→ 05/01; + EDS	24.2125-1712.3 010622	Ø 25,4
			→ 05/01; + ESP	24.2125-1713.3 010623	Ø 25,4
			06/01→	24.2125-1720.3 010688	TRW Ø 25,4
RS6 quattro	331	07/02→01/05		24.2126-1705.3 010999	TRW Ø 27
S6 quattro	250	09/99→01/05	4B-2-130136→	03.2125-0373.3 010810	ATE Ø 25,4
			→ 05/01	24.2125-1712.3 010622	Ø 25,4
				24.2125-1713.3 010623	Ø 25,4
		06/01→		24.2125-1720.3 010688	TRW Ø 25,4











AUDI - A6 C5 Avant (4B5, 4B6) 11/97→01/06

Bremskraftverstärker

1.8	85 - 92	12/97→01/05	4B-2-130001→	03.7858-4502.4 300202	ATE Ø 9 / 8" pneumatisch
1.8 T	110 - 132	12/97→01/05			
1.8 T quattro	110 - 132	12/97→01/05			
1.9 TDI	81 - 96	02/98→01/05			
2.0	96	08/01→01/05			
2.4	100 - 125	12/97→01/05			
2.4 quattro	115 - 125	12/97→01/05			
2.5 TDI	110 - 132	12/97→01/05			
2.5 TDI quattro	110 - 132	12/97→01/05			
2.7 T	169	02/99→01/05			
2.7 T quattro	169 - 184	12/97→01/05			
2.8	132 - 142	12/97→01/05			
2.8 quattro	142	12/97→01/05			
3.0	160 - 162	06/01→01/05			
3.0 quattro	160 - 162	06/01→01/05			
3.7	191	03/99→01/05			
3.7 quattro	191	03/99→01/05			
4.2 quattro	220	11/98→01/05			
S6 quattro	250	09/99→01/05			

Hauptbremszylinder

1.8	85 - 92	12/97→01/05	4B-2-130136→	03.2125-0373.3 010810	ATE Ø 25,4
1.8 T	110 - 132	12/97→01/05	→ 4B-X-130000; + EDS	24.2123-1717.3 010521	Ø 23,8
			→ 4B-X-130000; + ESP	24.2123-1730.3 010620	Ø 23,8
1.8 T quattro	110 - 132	12/97→01/05	4B-X-130001→; → 05/01; für Linkslenker; + EDS	24.2125-1712.3 010622	Ø 25,4
1.9 TDI	85	07/00→01/05			
2.4	100 - 121	12/97→01/05	4B-X-130001→; → 05/01; für Linkslenker; + ESP	24.2125-1713.3 010623	Ø 25,4
			06/01→	24.2125-1720.3 010688	TRW Ø 25,4
2.5 TDI	110	12/97→01/05			
2.5 TDI quattro	110 - 132	12/97→01/05			
2.8	140 - 142	12/97→01/05			
2.8 quattro	142	12/97→01/05			
1.9 TDI 2.4 quattro 2.8	81 - 132	02/98→04/01 08/98→05/01 12/97→05/00	4B-2-130136→	03.2125-0373.3 010810	ATE Ø 25,4
			→ 4B-X-130000; + EDS	24.2123-1717.3 010521	Ø 23,8
			→ 4B-X-130000; + ESP	24.2123-1730.3 010620	Ø 23,8
			4B-X-130001→; für Linkslenker; + EDS	24.2125-1712.3 010622	Ø 25,4
			4B-X-130001→; für Linkslenker; + ESP	24.2125-1713.3 010623	Ø 25,4
1.9 TDI	96	08/01→01/05	4B-2-130136→	03.2125-0373.3 010810	ATE Ø 25,4
2.4	125	08/01→01/05			
2.4 quattro	125	08/01→01/05	→ 4B-X-130000; + EDS	24.2123-1717.3 010521	Ø 23,8
2.5 TDI	114	08/01→01/05	→ 4B-X-130000; + ESP	24.2123-1730.3 010620	Ø 23,8
2.7 T quattro	184	08/01→01/05		24.2125-1720.3 010688	TRW Ø 25,4
2.0	96	08/01→01/05	4B-2-130136→	03.2125-0373.3 010810	ATE Ø 25,4
2.5 TDI	120	07/02→01/05			
3.0	160 - 162	06/01→01/05		24.2125-1720.3 010688	TRW Ø 25,4
→					

	kW			 	! #		
AUDI - A6 C5 Avant (4B5, 4B6) 11/97→01/06							
 Hauptbremszylinder							
3.0 quattro	160 - 162	06/01→01/05		4B-2-130136→		03.2125-0373.3 010810	ATE Ø 25,4
3.7	191	03/99→01/05				24.2125-1720.3 010688	TRW Ø 25,4
3.7 quattro	191	03/99→01/05					
2.5 TDI	132	02/00→01/05		4B-2-130136→		03.2125-0373.3 010810	ATE Ø 25,4
2.7 T	169	02/99→01/05		→ 05/01; für Linkslenker; + EDS		24.2125-1712.3 010622	Ø 25,4
				→ 05/01; für Linkslenker; + ESP		24.2125-1713.3 010623	Ø 25,4
				06/01→		24.2125-1720.3 010688	TRW Ø 25,4
2.7 T quattro	169	12/97→01/05		4B-2-130136→		03.2125-0373.3 010810	ATE Ø 25,4
				→ 4B-X-130000; + EDS		24.2123-1717.3 010521	Ø 23,8
				→ 4B-X-130000; + ESP		24.2123-1730.3 010620	Ø 23,8
				→ 05/01; für Linkslenker; + EDS		24.2125-1712.3 010622	Ø 25,4
				4B-X-130001→; → 05/01; für Linkslenker; + ESP		24.2125-1713.3 010623	Ø 25,4
				06/01→		24.2125-1720.3 010688	TRW Ø 25,4
4.2 quattro	220	11/98→01/05		4B-2-130136→		03.2125-0373.3 010810	ATE Ø 25,4
				→ 05/01; + EDS		24.2125-1712.3 010622	Ø 25,4
				→ 05/01; + ESP		24.2125-1713.3 010623	Ø 25,4
				06/01→		24.2125-1720.3 010688	TRW Ø 25,4
RS6 plus quattro	353	04/04→01/05				24.2126-1705.3 010999	TRW Ø 27
RS6 quattro	331	07/02→01/05					
S6 quattro	250	09/99→01/05		4B-2-130136→		03.2125-0373.3 010810	ATE Ø 25,4
				→ 05/01		24.2125-1712.3 010622	Ø 25,4
						24.2125-1713.3 010623	Ø 25,4
				06/01→		24.2125-1720.3 010688	TRW Ø 25,4
AUDI - A6 C6 (4F2) 04/04→08/11							
 Hauptbremszylinder							
2.0 TDI	89 - 125	07/04→03/11				24.2126-1705.3 010999	TRW Ø 27
2.0 TFSI	125	06/05→03/11					
2.4	130	05/04→10/08					
2.4 quattro	130	01/05→10/08					
2.7 TDI	120 - 140	11/04→03/11					
2.7 TDI quattro	120 - 140	11/04→03/11					
2.8 FSI	140 - 162	11/06→03/11					
2.8 FSI quattro	140 - 162	06/07→03/11					
3.0	160	08/04→05/06					
3.0 quattro	160	05/04→05/06					
3.0 TDI quattro	155 - 176	05/04→03/11					
3.0 TFSI quattro	213 - 220	10/08→03/11					
3.2 FSI	188 - 195	05/04→03/11					
3.2 FSI quattro	183 - 188	05/04→10/08					
4.2 FSI quattro	257	06/06→03/11					
4.2 quattro	246	05/04→05/06					
RS6 quattro	426	09/08→08/10					
S6 quattro	320	03/06→03/11					
2.0 TDI	100	07/04→03/11		06/05→		24.2126-1705.3 010999	TRW Ø 27
AUDI - A6 C6 Avant (4F5) 11/04→08/11							
 Hauptbremszylinder							
2.0 TDI	89 - 125	06/05→08/11				24.2126-1705.3 010999	TRW Ø 27
2.0 TFSI	125	06/05→08/11					
2.4	130	03/05→10/08					
2.4 quattro	130	03/05→10/08					
2.7 TDI	120 - 140	03/05→08/11					
2.7 TDI quattro	120 - 140	11/04→08/11					
2.8 FSI	140 - 162	11/06→08/11					
2.8 FSI quattro	140 - 162	06/07→08/11					
3.0	160	03/05→05/06					
3.0 quattro	160	03/05→05/06					
→							

AUDI - A6 C6 Avant (4F5) 11/04→08/11

Hauptbremszylinder

3.0 TDI quattro	155 - 176	03/05→08/11							24.2126-1705.3 010999	TRW Ø 27
3.0 TFSI quattro	213 - 220	10/08→08/11								
3.2 FSI	188	03/05→10/08								
3.2 FSI quattro	188	03/05→10/08								
4.2 FSI quattro	257	06/06→08/11								
4.2 quattro	246	03/05→05/06								
RS6 quattro	426	04/08→08/10								
S6 quattro	320	03/06→08/11								

AUDI - A6 C7 (4G2, 4GC) 11/10→11/19











Hauptbremszylinder













1.8 TFSI	140	09/14→09/18		für Linkslenker					24.2125-1749.3 011031	TRW Ø 25,4
2.0 TDI	100 - 140	01/12→09/18		für Rechtslenker					24.2125-1752.3 011134	TRW Ø 25,4 ohne Bremsflüssigkeitsbehälter
2.0 TDI quattro	140	04/15→09/18								
2.0 TFSI	132 - 185	05/11→09/18								
2.0 TFSI Hybrid	180	11/11→04/15								
2.0 TFSI quattro	155 - 185	05/12→09/18								
2.8 FSI quattro	162	09/14→09/18								
3.0 TDI	155 - 160	09/14→09/18								
3.0 TDI quattro	155 - 240	09/14→09/18								
3.0 TFSI quattro	245 - 250	09/14→09/18								
S6 quattro	331	10/14→09/18								
2.0 TDI	120 - 130	03/11→09/18		04/11→; für Linkslenker					24.2125-1749.3 011031	TRW Ø 25,4
2.0 TFSI	155	03/11→05/13		04/11→; für Rechtslenker					24.2125-1752.3 011134	TRW Ø 25,4 ohne Bremsflüssigkeitsbehälter
2.8 FSI	150	11/10→04/15								
2.8 FSI quattro	150	11/10→04/15								
3.0 TDI	150	11/10→09/18								
3.0 TDI quattro	150 - 180	03/11→09/18								
3.0 TFSI quattro	220 - 228	11/10→09/18								
2.0 TFSI	162	05/13→09/18		09/14→; für Linkslenker					24.2125-1749.3 011031	TRW Ø 25,4
				09/14→; für Rechtslenker					24.2125-1752.3 011134	TRW Ø 25,4 ohne Bremsflüssigkeitsbehälter
3.0 TDI quattro	230	11/11→09/18		12/11→; für Linkslenker					24.2125-1749.3 011031	TRW Ø 25,4
				12/11→; für Rechtslenker					24.2125-1752.3 011134	TRW Ø 25,4 ohne Bremsflüssigkeitsbehälter
S6 quattro	309	02/12→09/18		04/12→; für Linkslenker					24.2125-1749.3 011031	TRW Ø 25,4
				04/12→; für Rechtslenker					24.2125-1752.3 011134	TRW Ø 25,4 ohne Bremsflüssigkeitsbehälter













AUDI - A6 C7 Avant (4G5, 4GD) 05/11→11/19













Hauptbremszylinder

1.8 TFSI	140	09/14→09/18		für Linkslenker					24.2125-1749.3 011031	TRW Ø 25,4
2.0 TDI	100 - 140	01/12→09/18		für Rechtslenker					24.2125-1752.3 011134	TRW Ø 25,4 ohne Bremsflüssigkeitsbehälter
2.0 TDI quattro	140	04/15→09/18								
2.0 TFSI	132 - 185	06/11→09/18								
2.0 TFSI quattro	183 - 185	05/15→09/18								
2.8 FSI quattro	162	09/14→09/18								
3.0 TDI	155 - 160	09/14→09/18								
3.0 TDI quattro	155 - 240	09/14→09/18								
3.0 TFSI quattro	228 - 245	11/11→09/18								
RS6 performance quattro	445	11/15→09/18								
S6 quattro	331	10/14→09/18								
2.0 TDI	120 - 130	05/11→09/18		09/11→; für Linkslenker					24.2125-1749.3 011031	TRW Ø 25,4
2.8 FSI	150	05/11→04/15		09/11→; für Rechtslenker					24.2125-1752.3 011134	TRW Ø 25,4 ohne Bremsflüssigkeitsbehälter
2.8 FSI quattro	150	05/11→04/15								
3.0 TDI	150	05/11→09/18								
3.0 TDI quattro	150 - 180	05/11→09/18								
3.0 TFSI quattro	220	05/11→05/12								
→										













	kw					! #		
AUDI - A6 C7 Avant (4G5, 4GD) 05/11→11/19								
 Hauptbremszylinder								
3.0 TDI quattro	230	11/11→09/18		12/11→; für Linkslenker		24.2125-1749.3	011031	TRW Ø 25,4
				12/11→; für Rechtslenker		24.2125-1752.3	011134	TRW Ø 25,4 ohne Bremsflüssigkeitsbehälter
RS6 quattro	412	01/13→09/18		03/13→; für Linkslenker		24.2125-1749.3	011031	TRW Ø 25,4
				03/13→; für Rechtslenker		24.2125-1752.3	011134	TRW Ø 25,4 ohne Bremsflüssigkeitsbehälter
S6 quattro	309	02/12→09/18		04/12→; für Linkslenker		24.2125-1749.3	011031	TRW Ø 25,4
				04/12→; für Rechtslenker		24.2125-1752.3	011134	TRW Ø 25,4 ohne Bremsflüssigkeitsbehälter
AUDI - A7 Sportback (4GA, 4GF) 07/10→11/19								
 Hauptbremszylinder								
1.8 TFSI	140	04/15→05/18		für Linkslenker		24.2125-1749.3	011031	TRW Ø 25,4
2.0 TFSI	185	09/14→05/18		für Rechtslenker		24.2125-1752.3	011134	TRW Ø 25,4 ohne Bremsflüssigkeitsbehälter
2.0 TFSI quattro	183 - 185	05/15→05/18						
2.8 FSI quattro	150 - 162	10/10→05/18						
3.0 TDI	140 - 160	11/10→05/18						
3.0 TDI quattro	140 - 240	10/10→05/18						
3.0 TFSI quattro	220 - 245	10/10→05/18						
3.0 TFSI QUATTRO	250	05/16→05/18						
RS7 performance quattro	445	11/15→04/18						
RS7 quattro	412	10/13→04/18						
S7 quattro	309 - 331	02/12→05/18						
2.8 FSI	150	02/11→03/15		05/11→; für Linkslenker		24.2125-1749.3	011031	TRW Ø 25,4
				05/11→; für Rechtslenker		24.2125-1752.3	011134	TRW Ø 25,4 ohne Bremsflüssigkeitsbehälter
AUDI - A8 D2 (4D2, 4D8) 03/94→12/05								
 Hauptbremszylinder								
2.5 TDI	110	01/97→04/00		06/97→; - ESP		24.2125-1712.3	010622	Ø 25,4
				06/97→; + ESP		24.2125-1713.3	010623	Ø 25,4
2.5 TDI	132	09/00→09/02		- ESP		24.2125-1712.3	010622	Ø 25,4
2.5 TDI quattro	110 - 132	07/97→09/02		+ ESP		24.2125-1713.3	010623	Ø 25,4
2.8	142	04/96→09/02						
2.8 quattro	142	04/96→09/02						
3.3 TDI quattro	165	06/00→09/02						
3.7	191	11/98→09/02						
3.7 quattro	191	11/98→09/02						
4.2 quattro	175 - 228	11/98→09/02						
6.0 W12 quattro	309	01/01→09/02						
S8 quattro	265	06/99→09/02						
AUDI - A8 D4 (4H2, 4H8, 4HC, 4HL) 11/09→11/19								
 Hauptbremszylinder								
2.0 TFSI hybrid	180	02/12→11/15		05/12→; nicht für gepanzerte Fahrzeuge		24.2125-1739.3	010948	TRW Ø 25,4
2.0 TFSI quattro	185	09/16→01/18		nicht für gepanzerte Fahrzeuge		24.2125-1739.3	010948	TRW Ø 25,4
2.5 TFSI	150	07/12→06/16						
3.0 TDI	150	09/11→09/13						
3.0 TDI quattro	155 - 193	07/10→01/18						
3.0 TFSI quattro	213 - 228	07/10→01/18						
4.0 TFSI quattro	309 - 320	03/12→12/15						
4.2 FSI quattro	273	11/09→12/12						
4.2 TDI quattro	258 - 283	11/09→01/18						
6.3 W12 quattro	368	01/11→01/18						
S8 plus quattro	445	11/15→01/18						
S8 quattro	382	04/12→01/18						
3.0 TFSI quattro	245	06/10→01/18		07/10→; nicht für gepanzerte Fahrzeuge		24.2125-1739.3	010948	TRW Ø 25,4













	kw					! #		
AUDI - ALLROAD C5 (4BH) 05/00→08/05								
 Hauptbremszylinder								
2.5 TDI quattro	120 - 132	05/00→08/05		für Linkslenker; → 07/05		24.2125-1713.3	010623	Ø 25,4
2.7 quattro	187	09/00→08/05						
2.7 T quattro	184	05/00→08/05						
4.2 V8 quattro	220	07/02→08/05						
AUDI - CABRIOLET B3 (8G7) 05/91→08/00								
 Hauptbremszylinder								
1.9 TDI	66	06/95→08/00		07/95→; für Linkslenker; + ABS		24.2123-1602.3	010384	TRW Ø 23,8
2.6	110	06/93→08/00		01/94→; für Linkslenker		24.2123-1602.3	010384	TRW Ø 23,8
2.8	128	11/92→08/00		für Linkslenker		24.2123-1602.3	010384	TRW Ø 23,8
Verschlusschraube, Hauptbremszylinder								
1.9 TDI	66	06/95→08/00		8G-P-000001→ 8G-V-010000; für Linkslenker; - ABS		03.3517-0101.2	390322	
AUDI - Q2 (GAB, GAG) 06/16→								
 Hauptbremszylinder								
1.0 TFSI	85	10/16→10/20		für Linkslenker; → 03/18		24.4123-1719.3	011017	TRW Ø 23,8 ohne Bremsflüssigkeitsbehälter
2.0 TDI	110	09/16→						
2.0 TDI quattro	110	09/16→		für Linkslenker; → 11/18		24.4153-1522.3	011048	ATE Ø 23,8 ohne Bremsflüssigkeitsbehälter
2.0 TFSI quattro	140	05/17→						
35 TDI	110	09/16→		für Linkslenker; 12/18→; +PR 1ZA / 1ZB / 1ZE / 1ZJ / 1ZK / 1ZU		24.4153-1522.3	011048	ATE Ø 23,8 ohne Bremsflüssigkeitsbehälter
1.4 TFSI	110	06/16→08/18		für Linkslenker; → 03/18		24.4123-1719.3	011017	TRW Ø 23,8 ohne Bremsflüssigkeitsbehälter
1.6 TDI	85	06/16→07/18						
2.0 TDI quattro	140	07/16→08/18		für Linkslenker		24.4153-1522.3	011048	ATE Ø 23,8 ohne Bremsflüssigkeitsbehälter
30 TDI	85	07/18→10/20		für Linkslenker; → 11/18		24.4153-1522.3	011048	ATE Ø 23,8 ohne Bremsflüssigkeitsbehälter
30 TFSI	85	07/18→10/20						
35 TDI quattro	110	09/18→		für Linkslenker; 12/18→; +PR 1ZA / 1ZB / 1ZE / 1ZJ / 1ZK / 1ZU		24.4153-1522.3	011048	ATE Ø 23,8 ohne Bremsflüssigkeitsbehälter
35 TFSI	110	07/18→						
40 TFSI quattro	140	09/18→						
SQ2 TFSI quattro	221	08/18→						
30 TFSI	81	08/20→		für Linkslenker; +PR 1ZA / 1ZB / 1ZE / 1ZJ / 1ZK / 1ZU		24.4153-1522.3	011048	ATE Ø 23,8 ohne Bremsflüssigkeitsbehälter
AUDI - Q3 (8UB, 8UG) 06/11→03/20								
 Bremskraftverstärker								
1.4 TFSI	92	07/16→10/18		für Linkslenker		03.7870-3002.4	300342	ATE Ø 11" pneumatisch
1.4 TSI	110	10/13→10/18						
2.0 TDI	88 - 135	06/11→10/18						
2.0 TDI quattro	103 - 135	06/11→10/18						
2.0 TFSI	132	05/15→10/18						
2.0 TFSI quattro	125 - 162	06/11→10/18						
 Hauptbremszylinder								
1.4 TFSI	92	07/16→10/18		für Linkslenker		03.2123-3549.3	010809	ATE Ø 23,8
1.4 TSI	110	10/13→10/18						
2.0 TDI	88 - 135	06/11→10/18		für Rechtslenker		24.4153-0192.3	011026	ATE Ø 23,8 ohne Bremsflüssigkeitsbehälter
2.0 TDI quattro	103 - 135	06/11→10/18						
2.0 TFSI	132	05/15→10/18		für Linkslenker		03.4153-0186.3	010816	ATE Ø 23,8
2.0 TFSI quattro	132 - 162	11/14→10/18		für Rechtslenker		24.4153-0192.3	011026	ATE Ø 23,8 ohne Bremsflüssigkeitsbehälter
2.0 TFSI quattro	125 - 155	06/11→10/18		für Linkslenker		03.2123-3549.3	010809	ATE Ø 23,8
				für Rechtslenker		03.4153-0186.3	010816	ATE Ø 23,8
						24.4153-0192.3	011026	ATE Ø 23,8 ohne Bremsflüssigkeitsbehälter
RS 2.5 quattro	228	10/13→10/18		für Linkslenker		03.2125-5112.3	010966	ATE Ø 25,4
RS performance 2.5 quattro	270	01/15→10/18						
RS 2.5 quattro	250	05/13→10/18		03/15→; für Linkslenker		03.2125-5112.3	010966	ATE Ø 25,4
AUDI - Q3 (F3B) 07/18→								
 Hauptbremszylinder								
35 TDI	110	09/18→		+PR 1ZA / 1ZD; für Linkslenker		24.2123-1782.3	011146	TRW Ø 23,8 ohne Bremsflüssigkeitsbehälter
35 TDI quattro	110	09/18→						

	kw			 	! #		
AUDI - Q3 (F3B) 07/18→							
 Hauptbremszylinder							
35 TFSI	110	08/18→		+PR 1ZA / 1ZD; für Linkslenker		24.2123-1782.3 011146	TRW Ø 23,8 ohne Bremsflüssigkeitsbehälter
35 TFSI Mild Hybrid	110	11/19→					
40 TDI quattro	140	10/18→					
	147						
40 TFSI quattro	140	07/18→					
45 TFSI e	180	11/20→					
45 TFSI quattro	169	07/18→					
	180						
AUDI - Q3 Sportback (F3N) 06/19→							
 Hauptbremszylinder							
35 TDI	110	11/19→		+PR 1ZA / 1ZD; für Linkslenker		24.2123-1782.3 011146	TRW Ø 23,8 ohne Bremsflüssigkeitsbehälter
35 TDI quattro	110	09/19→					
35 TFSI	110	09/19→					
35 TFSI Mild Hybrid	110	11/19→					
40 TDI quattro	140	07/19→					
	147						
40 TFSI quattro	140	11/19→					
45 TFSI e	180	11/20→					
45 TFSI quattro	169	06/19→					
	180						
AUDI - Q5 (8RB) 11/08→04/19							
 Bremskraftverstärker							
2.0 TDI	100 - 140	11/10→05/17				03.7858-4432.4 300304	ATE Ø 9 / 8" pneumatisch
2.0 TDI quattro	100 - 140	08/09→05/17					
2.0 TFSI quattro	132 - 169	08/09→05/17					
3.0 TDI quattro	190	11/13→05/17					
SQ5 TDI quattro	230 - 250	12/12→05/17					
SQ5 TFSI quattro	260	05/13→05/17					
2.0 TDI quattro	120 - 125	11/08→05/17		→ 02/09		03.7858-4432.4 300304	ATE Ø 9 / 8" pneumatisch
2.0 TFSI quattro	155	11/08→09/12		03/09→		03.7858-4432.4 300304	ATE Ø 9 / 8" pneumatisch
3.0 TDI quattro	155 - 176	11/08→05/17					
3.2 FSI quattro	199	11/08→12/12					
2.0 TDI quattro	130	06/12→05/17		09/12→		03.7858-4432.4 300304	ATE Ø 9 / 8" pneumatisch
2.0 TFSI quattro	165	06/12→05/16					
3.0 TDI quattro	180 - 184	06/12→05/17					
3.0 TFSI quattro	200	06/12→05/17					
2.0 TFSI Hybrid quattro	180	06/11→06/16				03.7858-4632.4 300273	ATE Ø 9 / 8" pneumatisch
 Hauptbremszylinder							
2.0 TDI	100 - 140	11/10→05/17				03.2125-0493.3 010940	ATE Ø 25,4
2.0 TDI quattro	100 - 140	08/09→05/17					
2.0 TFSI quattro	132 - 162	08/09→05/17					
3.0 TDI quattro	190	11/13→05/17					
SQ5 TDI quattro	230 - 250	12/12→05/17					
SQ5 TFSI quattro	260	05/13→05/17					
2.0 TDI quattro	120 - 125	11/08→05/17		03/09→		03.2125-0493.3 010940	ATE Ø 25,4
2.0 TFSI quattro	155	11/08→09/12					
3.0 TDI quattro	155 - 176	11/08→05/17					
3.2 FSI quattro	199	11/08→12/12					
2.0 TDI quattro	130	06/12→05/17		09/12→		03.2125-0493.3 010940	ATE Ø 25,4
2.0 TFSI quattro	165	06/12→05/16					
3.0 TDI quattro	180 - 184	06/12→05/17					
3.0 TFSI quattro	200	06/12→05/17					
AUDI - Q5 Van (8RB) 11/08→12/17							
 Bremskraftverstärker							
2.0 TDI	100 - 140	11/11→05/17				03.7858-4432.4 300304	ATE Ø 9 / 8" pneumatisch
3.0 SQ5 TDI quattro	230 - 250	12/12→05/17					
3.0 TDI quattro	190	11/13→05/17					
2.0 TDI quattro	125	11/08→09/12		→ 02/09		03.7858-4432.4 300304	ATE Ø 9 / 8" pneumatisch
→							











	kw					! #		
AUDI - Q5 Van (8RB) 11/08→12/17								
 Bremskraftverstärker								
2.0 TFSI quattro	155	11/08→09/12		03/09→			03.7858-4432.4 300304	ATE Ø 9 / 8" pneumatisch
3.0 TDI quattro	176	11/08→04/13						
3.2 FSI quattro	199	11/08→09/12						
2.0 TDI quattro	130	07/12→06/14		09/12→			03.7858-4432.4 300304	ATE Ø 9 / 8" pneumatisch
3.0 TDI quattro	180	06/12→05/17						
 Hauptbremszylinder								
2.0 TDI	100 - 140	11/11→05/17					03.2125-0493.3 010940	ATE Ø 25,4
3.0 SQ5 TDI quattro	230 - 250	12/12→05/17						
3.0 TDI quattro	190	11/13→05/17						
2.0 TDI quattro	125	11/08→09/12		03/09→			03.2125-0493.3 010940	ATE Ø 25,4
2.0 TFSI quattro	155	11/08→09/12						
3.0 TDI quattro	176	11/08→04/13						
3.2 FSI quattro	199	11/08→09/12						
2.0 TDI quattro	130	07/12→06/14		09/12→			03.2125-0493.3 010940	ATE Ø 25,4
3.0 TDI quattro	180	06/12→05/17						
AUDI - Q7 (4LB) 03/06→01/16								
 Bremskraftverstärker								
3.0 TDI quattro	150 - 180	03/06→08/15		für Linkslenker; für Fahrzeuge ohne autom. Distanzregelung			03.7868-5802.4 300315	ATE Ø 10 / 8" pneumatisch
3.0 TFSI quattro	200 - 245	05/10→08/15		für Linkslenker; für Fahrzeuge mit autom. Distanzregelung			03.7868-5902.4 300316	ATE Ø 10 / 8" pneumatisch
3.6 FSI quattro	206	08/06→05/10						
4.2 FSI quattro	257	03/06→05/10						
4.2 TDI quattro	240 - 250	03/07→08/15						
6.0 TDI quattro	368	09/08→05/14						
Pedalwegsensor, Bremspedal								
3.0 TDI quattro	150 - 180	03/06→08/15		für Fahrzeuge mit autom. Distanzregelung			03.0655-0006.2 370006	ATE
3.0 TFSI quattro	200 - 245	05/10→08/15						
3.6 FSI quattro	206	08/06→05/10						
4.2 FSI quattro	257	03/06→05/10						
4.2 TDI quattro	240 - 250	03/07→08/15						
6.0 TDI quattro	368	09/08→05/14						
 Hauptbremszylinder								
3.0 TDI quattro	150 - 180	03/06→08/15		für Linkslenker			03.2126-3063.3 010812	ATE Ø 27
3.0 TFSI quattro	200 - 245	05/10→08/15		für Rechtslenker			24.2126-3071.3 011037	ATE Ø 27 ohne Bremsflüssigkeitsbehälter
3.6 FSI quattro	206	08/06→05/10						
4.2 FSI quattro	257	03/06→05/10						
4.2 TDI quattro	240 - 250	03/07→08/15						
6.0 TDI quattro	368	09/08→05/14						
3.0 TDI quattro	165	06/09→05/12		für Linkslenker			03.2126-3063.3 010812	ATE Ø 27
				→ 05/10; für Rechtslenker			24.2126-3071.3 011037	ATE Ø 27 ohne Bremsflüssigkeitsbehälter
AUDI - Q7 Van (4LB) 03/06→01/16								
 Bremskraftverstärker								
3.0 TDI quattro	150 - 180	03/06→08/15		für Linkslenker; für Fahrzeuge ohne autom. Distanzregelung			03.7868-5802.4 300315	ATE Ø 10 / 8" pneumatisch
3.0 TFSI quattro	245	05/10→08/15		für Linkslenker; für Fahrzeuge mit autom. Distanzregelung			03.7868-5902.4 300316	ATE Ø 10 / 8" pneumatisch
3.6 FSI quattro	206	08/06→05/10						
4.2 FSI quattro	257	08/06→05/10						
4.2 TDI quattro	240 - 250	03/07→08/15						
6.0 TDI quattro	368	09/08→05/14						
Pedalwegsensor, Bremspedal								
3.0 TDI quattro	150 - 180	03/06→08/15		für Fahrzeuge mit autom. Distanzregelung			03.0655-0006.2 370006	ATE
3.0 TFSI quattro	245	05/10→08/15						
3.6 FSI quattro	206	08/06→05/10						
4.2 FSI quattro	257	08/06→05/10						
4.2 TDI quattro	240 - 250	03/07→08/15						
6.0 TDI quattro	368	09/08→05/14						
→								



















	kw			 	! #		
AUDI - Q7 Van (4LB) 03/06→01/16							
 Hauptbremszylinder							
3.0 TDI quattro	150 - 180	03/06→08/15		für Linkslenker		03.2126-3063.3 010812	ATE Ø 27
3.0 TFSI quattro	245	05/10→08/15		für Rechtslenker		24.2126-3071.3 011037	ATE Ø 27 ohne Bremsflüssigkeitsbehälter
3.6 FSI quattro	206	08/06→05/10					
4.2 FSI quattro	257	08/06→05/10					
4.2 TDI quattro	240 - 250	03/07→08/15					
6.0 TDI quattro	368	09/08→05/14					
AUDI - TT (8J3) 07/06→02/15							
 Bremskraftverstärker							
1.8 TFSI	118	06/08→06/14		für Linkslenker		03.7860-4203.4 300243	ATE Ø 10" pneumatisch
2.0 TDI quattro	125	06/08→06/14					
2.0 TFSI	147 - 155	08/06→06/14					
2.0 TFSI quattro	147 - 155	06/08→06/14					
2.0 TTS quattro	195	05/08→06/14					
2.0 TTS quattro	200	05/08→06/14		für Linkslenker		03.7870-0602.4 300310	ATE Ø 11" pneumatisch
2.5 RS quattro	250	07/09→06/14					
2.5 RS quattro	265	05/11→06/14		02/12→; für Linkslenker		03.7870-0602.4 300310	ATE Ø 11" pneumatisch
3.2 V6 quattro	184	08/06→06/10		für Linkslenker; +PR 1AT		03.7870-0602.4 300310	ATE Ø 11" pneumatisch
 Hauptbremszylinder							
1.8 TFSI	118	06/08→06/14		für Linkslenker		03.2123-3549.3 010809	ATE Ø 23,8
2.0 TDI quattro	125	06/08→06/14		für Rechtslenker		24.4153-0217.3 011039	ATE Ø 23,8 ohne Bremsflüssigkeitsbehälter
2.0 TFSI	147 - 155	08/06→06/14					
2.0 TFSI quattro	147 - 155	06/08→06/14					
2.0 TTS quattro	195	05/08→06/14					
2.0 TTS quattro	200	05/08→06/14		für Linkslenker		03.2125-5112.3 010966	ATE Ø 25,4
2.5 RS quattro	250 - 265	07/09→06/14					
3.2 V6 quattro	184	08/06→06/10					
Drucksensor, Bremskraftverstärker							
2.0 TTS quattro	200	05/08→06/14		für Rechtslenker; +PR 1AS		03.0655-0101.2 370008	ATE
2.5 RS quattro	250 - 265	07/09→06/14					
3.2 V6 quattro	184	08/06→06/10		für Linkslenker; +PR 1AS		03.0655-0101.2 370008	ATE
AUDI - TT (8N3) 10/98→02/07							
 Bremskraftverstärker							
1.8 T	110 - 140	09/02→06/06		für Linkslenker		03.7860-0602.4 300141	ATE Ø 10" pneumatisch
1.8 T quattro	140 - 180	03/05→06/06					
3.2 VR6 quattro	184	07/03→06/06					
1.8 T	132	10/98→06/06		8N-2-014301→; für Linkslenker		03.7860-0602.4 300141	ATE Ø 10" pneumatisch
1.8 T quattro	132 - 165	10/98→06/06		→ 8N-2-014300; für Linkslenker; + ESP		03.7863-0402.4 300124	ATE Ø 10" pneumatisch
 Hauptbremszylinder							
1.8 T	132	10/98→06/06		→ 8N-2-014300; für Linkslenker; + ESP		03.2123-2024.3 010597	ATE Ø 23,8
1.8 T quattro	132 - 165	10/98→06/06		8N-2-014301→; → 08/02; für Linkslenker		03.2123-2715.3 010802	ATE Ø 23,8
				8N-2-014301→; → 08/02; für Rechtslenker		03.2123-2774.3 010803	ATE Ø 23,8
				→ 8N-2-014300; für Linkslenker; - ESP		24.2123-1709.3 010503	Ø 23,8
AUDI - TT (FV3, FVP) 07/14→							
 Hauptbremszylinder							
1.8 TFSI	132	07/15→08/18		für Linkslenker		24.4123-1719.3 011017	TRW Ø 23,8 ohne Bremsflüssigkeitsbehälter
2.0 TDI	135	07/14→					
2.0 TDI quattro	135	01/17→					
2.0 TFSI	169	07/14→					
2.0 TFSI quattro	162 - 169	07/14→					
2.0 TTS quattro	210 - 228	11/14→					
40 TFSI	145	07/18→					
45 TFSI	180	07/18→					
45 TFSI quattro	180	07/18→					
TTS quattro	235	01/21→					













	kw					! #		
AUDI - TT Roadster (8J9) 03/07→09/14								
 Bremskraftverstärker								
1.8 TFSI 2.0 TDI quattro 2.0 TFSI	118 125 147 - 155	06/08→06/14 06/08→06/14 03/07→06/14		für Linkslenker			03.7860-4203.4 300243	ATE Ø 10" pneumatisch
2.0 TFSI quattro 2.0 TTS quattro	147 - 155 195	06/08→06/14 05/08→06/14		für Linkslenker			03.7870-0602.4 300310	ATE Ø 11" pneumatisch
2.0 TTS quattro 2.5 RS quattro	200 250 - 265	05/08→06/14 07/09→06/14		für Linkslenker			03.7870-0602.4 300310	ATE Ø 11" pneumatisch
3.2 V6 quattro	184	03/07→06/10		für Linkslenker; +PR 1AT			03.7870-0602.4 300310	ATE Ø 11" pneumatisch
 Hauptbremszylinder								
1.8 TFSI 2.0 TDI quattro 2.0 TFSI 2.0 TFSI quattro 2.0 TTS quattro	118 125 147 147 195	06/08→06/14 06/08→06/14 03/07→06/10 06/08→06/10 05/08→06/14		für Linkslenker für Rechtslenker			03.2123-3549.3 010809 24.4153-0217.3 011039	ATE Ø 23,8 ATE Ø 23,8 ohne Bremsflüssigkeitsbehälter
2.0 TTS quattro 2.5 RS quattro 3.2 V6 quattro	200 250 - 265 184	05/08→06/14 07/09→06/14 03/07→06/10		für Linkslenker			03.2125-5112.3 010966	ATE Ø 25,4
Drucksensor, Bremskraftverstärker								
2.0 TTS quattro 2.5 RS quattro	200 250 - 265	05/08→06/14 07/09→06/14		für Rechtslenker; +PR 1AS			03.0655-0101.2 370008	ATE
3.2 V6 quattro	184	03/07→06/10		für Linkslenker; +PR 1AS			03.0655-0101.2 370008	ATE
AUDI - TT Roadster (8N9) 10/99→02/07								
 Bremskraftverstärker								
1.8 T 1.8 T quattro	110 - 132 132 - 165	10/99→06/06 10/99→06/06		8N-2-014301→; für Linkslenker → 8N-2-014300; für Linkslenker; + ESP			03.7860-0602.4 300141 03.7863-0402.4 300124	ATE Ø 10" pneumatisch ATE Ø 10" pneumatisch
1.8 T 1.8 T quattro 3.2 VR6 quattro	120 - 140 140 184	09/05→06/06 09/05→06/06 07/03→06/06		für Linkslenker			03.7860-0602.4 300141	ATE Ø 10" pneumatisch
 Hauptbremszylinder								
1.8 T 1.8 T quattro	110 - 132 132 - 165	10/99→06/06 10/99→06/06		→ 8N-2-014300; für Linkslenker; + ESP 8N-2-014301→; → 08/02; für Linkslenker 8N-2-014301→; → 08/02; für Rechtslenker → 8N-2-014300; für Linkslenker; - ESP			03.2123-2024.3 010597 03.2123-2715.3 010802 03.2123-2774.3 010803 24.2123-1709.3 010503	ATE Ø 23,8 ATE Ø 23,8 ATE Ø 23,8 Ø 23,8
AUDI - TT Roadster (FV9, FVR) 11/14→								
 Hauptbremszylinder								
1.8 TFSI 2.0 TDI 2.0 TDI quattro 2.0 TFSI 2.0 TFSI quattro 2.0 TTS quattro 40 TFSI 45 TFSI 45 TFSI quattro TTS quattro	132 135 135 169 162 - 169 210 - 228 145 180 180 235	07/15→08/18 11/14→ 01/17→ 11/14→ 11/14→ 11/14→ 07/18→ 07/18→ 07/18→ 11/20→		für Linkslenker			24.4123-1719.3 011017	TRW Ø 23,8 ohne Bremsflüssigkeitsbehälter
BMW - 1 (E81) 09/06→09/12								
 Bremskraftverstärker								
116 d 118 i	66 95 - 100	01/11→12/11 09/06→12/11		für Fahrzeuge ohne Start-Stopp-Funktion			03.7848-4003.4 300235	ATE Ø 8" pneumatisch
116 d	85	11/08→12/11		09/09→ 05/11; für Fahrzeuge ohne Start-Stopp-Funktion 03/09→ 08/09			03.7848-4003.4 300235 03.7848-4003.4 300235	ATE Ø 8" pneumatisch ATE Ø 8" pneumatisch
116 i 120 d	85 120	09/07→12/11 03/07→12/11					03.7848-4003.4 300235	ATE Ø 8" pneumatisch
116 i	90	03/07→12/11		09/07→ 12/08			03.7848-4003.4 300235	ATE Ø 8" pneumatisch
→								

























	kw			 	! #		
BMW - 1 (E81) 09/06→09/12							
 Bremskraftverstärker							
116 i	90	11/08→12/11		09/09→ 05/11; für Fahrzeuge ohne Start-Stopp-Funktion		03.7848-4003.4 300235	ATE Ø 8" pneumatisch
				01/09→ 08/09		03.7848-4003.4 300235	ATE Ø 8" pneumatisch
118 d	100 - 105	09/06→12/11		09/09→ 05/11; für Fahrzeuge ohne Start-Stopp-Funktion		03.7848-4003.4 300235	ATE Ø 8" pneumatisch
118 i 120 i	105 120 - 125	09/06→12/11 03/07→09/12		04/07→ 08/09		03.7848-4003.4 300235	ATE Ø 8" pneumatisch
120 d	130 - 145	03/07→12/11		09/09→ 05/11; für Fahrzeuge ohne Start-Stopp-Funktion		03.7848-4003.4 300235	ATE Ø 8" pneumatisch
				→ 08/09		03.7848-4003.4 300235	ATE Ø 8" pneumatisch
120 i	115	03/07→12/11		→ 03/07		03.7848-4003.4 300235	ATE Ø 8" pneumatisch
123 d	150	03/07→12/11		09/09→ 05/11; für Fahrzeuge ohne Start-Stopp-Funktion		03.7848-5003.4 300236	ATE Ø 8" pneumatisch
				10/07→ 08/09		03.7848-5003.4 300236	ATE Ø 8" pneumatisch
130 i	190 - 195	09/06→12/11		→ 05/11		03.7848-5003.4 300236	ATE Ø 8" pneumatisch
 Hauptbremszylinder							
116 d 116 i 118 i	66 85 95 - 100	01/11→12/11 09/07→12/11 09/06→12/11		für Linkslenker		03.2023-2407.3 010796	ATE Ø1 23,8 Ø2 22,2
120 d	120	03/07→12/11					
116 d	85	11/08→12/11		03/09→ 05/11; für Linkslenker		03.2023-2407.3 010796	ATE Ø1 23,8 Ø2 22,2
116 i	90	03/07→12/11		09/07→ 12/08; für Linkslenker		03.2023-2407.3 010796	ATE Ø1 23,8 Ø2 22,2
116 i	90	11/08→12/11		01/09→ 05/11; für Linkslenker		03.2023-2407.3 010796	ATE Ø1 23,8 Ø2 22,2
118 d	100 - 105	09/06→12/11		04/07→ 05/11; für Linkslenker		03.2023-2407.3 010796	ATE Ø1 23,8 Ø2 22,2
118 i 120 i	105 120 - 125	09/06→12/11 03/07→09/12					
120 d	130 - 145	03/07→12/11		→ 05/11; für Linkslenker		03.2023-2407.3 010796	ATE Ø1 23,8 Ø2 22,2
120 i	115	03/07→12/11		→ 03/07; für Linkslenker		03.2023-2407.3 010796	ATE Ø1 23,8 Ø2 22,2
123 d	150	03/07→12/11		10/07→ 05/11; für Linkslenker		03.2025-1904.3 010797	ATE Ø1 25,4 Ø2 22,2
130 i	190 - 195	09/06→12/11		→ 05/11; für Linkslenker		03.2025-1904.3 010797	ATE Ø1 25,4 Ø2 22,2
Hydraulikaggregat, Bremsanlage							
116 d	66	01/11→12/11				24.9145-0003.2 399007	
116 d	85	11/08→12/11		03/09→ 05/11		24.9145-0003.2 399007	
116 i	90	03/07→12/11		09/08→ 12/08		24.9145-0003.2 399007	
116 i	90	11/08→12/11		01/09→ 05/11		24.9145-0003.2 399007	
118 d	100 - 105	09/06→12/11		09/08→ 05/11		24.9145-0003.2 399007	
118 i 120 d	105 130 - 145	09/06→12/11 03/07→12/11					
120 i	120 - 125	03/07→09/12					
118 i	100	09/06→12/11		09/08→		24.9145-0003.2 399007	
123 d	150	03/07→12/11		09/08→ 05/11; für Fahrzeuge ohne Aktivlenkung		24.9145-0003.2 399007	
BMW - 1 (E87) 02/03→01/13							
 Bremskraftverstärker							
116 d	66	01/11→12/11		für Fahrzeuge ohne Start-Stopp-Funktion		03.7848-4003.4 300235	ATE Ø 8" pneumatisch
116 d 116 i 120 d	85 90 130	03/09→06/11 01/09→06/11 03/07→06/11		09/09→ 05/11; für Fahrzeuge ohne Start-Stopp-Funktion		03.7848-4003.4 300235	ATE Ø 8" pneumatisch
				→ 08/09		03.7848-4003.4 300235	ATE Ø 8" pneumatisch
116 i	85	06/04→06/11		09/04→ 08/07		03.7848-4003.4 300235	ATE Ø 8" pneumatisch
116 i	90	09/07→06/11		→ 12/08		03.7848-4003.4 300235	ATE Ø 8" pneumatisch
118 d 118 i 120 d	90 95 110	06/04→02/07 07/04→02/07 06/04→02/07		09/04→		03.7848-4003.4 300235	ATE Ø 8" pneumatisch
118 d	100 - 105	03/07→06/11		09/09→ 05/11; für Fahrzeuge ohne Start-Stopp-Funktion		03.7848-4003.4 300235	ATE Ø 8" pneumatisch
118 i 120 i	105 120 - 125	09/06→06/11 03/07→06/11		04/07→ 08/09		03.7848-4003.4 300235	ATE Ø 8" pneumatisch
118 i →	100	10/06→06/11		→ 03/07		03.7848-4003.4 300235	ATE Ø 8" pneumatisch











	kw			 	! #		
BMW - 1 (E87) 02/03→01/13							
 Bremskraftverstärker							
120 i	115	03/07→06/11		→ 03/07		03.7848-4003.4 300235	ATE Ø 8" pneumatisch
118 i	125	03/07→12/07		04/07→		03.7848-4003.4 300235	ATE Ø 8" pneumatisch
120 d	120	06/04→06/11		09/04→ 02/07		03.7848-4003.4 300235	ATE Ø 8" pneumatisch
120 i	110	06/04→02/07				03.7848-4003.4 300235	ATE Ø 8" pneumatisch
123 d	150	03/07→06/11		09/09→ 05/11; für Fahrzeuge ohne Start-Stopp-Funktion		03.7848-5003.4 300236	ATE Ø 8" pneumatisch
				10/07→ 08/09		03.7848-5003.4 300236	ATE Ø 8" pneumatisch
130 i	190	03/07→06/11		→ 05/11		03.7848-5003.4 300236	ATE Ø 8" pneumatisch
130 i	195	09/05→02/07				03.7848-5003.4 300236	ATE Ø 8" pneumatisch
 Hauptbremszylinder							
116 d	66	01/11→12/11		für Linkslenker		03.2023-2407.3 010796	ATE Ø1 23,8 Ø2 22,2
116 d	85	03/09→06/11		→ 05/11; für Linkslenker		03.2023-2407.3 010796	ATE Ø1 23,8 Ø2 22,2
116 i	90	01/09→06/11					
120 d	130	03/07→06/11					
116 i	85	06/04→06/11		09/04→ 08/07; für Linkslenker		03.2023-2407.3 010796	ATE Ø1 23,8 Ø2 22,2
116 i	90	09/07→06/11		→ 12/08; für Linkslenker		03.2023-2407.3 010796	ATE Ø1 23,8 Ø2 22,2
118 d	90	06/04→02/07		09/04→; für Linkslenker		03.2023-2407.3 010796	ATE Ø1 23,8 Ø2 22,2
118 i	95	07/04→02/07					
120 d	110	06/04→02/07					
120 i	110	06/04→02/07					
118 d	100 -	03/07→06/11		04/07→ 05/11; für Linkslenker		03.2023-2407.3 010796	ATE Ø1 23,8 Ø2 22,2
	105						
	105	09/06→06/11					
120 i	120 -	03/07→06/11					
125							
118 i	100	10/06→06/11		→ 03/07; für Linkslenker		03.2023-2407.3 010796	ATE Ø1 23,8 Ø2 22,2
120 i	115	03/07→06/11					
118 i	125	03/07→12/07		04/07→; für Linkslenker		03.2023-2407.3 010796	ATE Ø1 23,8 Ø2 22,2
120 d	120	06/04→06/11		09/04→ 02/07; für Linkslenker		03.2023-2407.3 010796	ATE Ø1 23,8 Ø2 22,2
123 d	150	03/07→06/11		10/07→ 05/11; für Linkslenker		03.2025-1904.3 010797	ATE Ø1 25,4 Ø2 22,2
130 i	190	03/07→06/11		→ 05/11; für Linkslenker		03.2025-1904.3 010797	ATE Ø1 25,4 Ø2 22,2
130 i	195	09/05→02/07		für Linkslenker		03.2025-1904.3 010797	ATE Ø1 25,4 Ø2 22,2
Hydraulikaggregat, Bremsanlage							
116 d	66	01/11→12/11				24.9145-0003.2 399007	
116 d	85	03/09→06/11		→ 05/11		24.9145-0003.2 399007	
116 i	90	01/09→06/11					
116 i	90	09/07→06/11		09/08→ 12/08		24.9145-0003.2 399007	
118 d	100 -	03/07→06/11		09/08→ 05/11		24.9145-0003.2 399007	
	105						
118 i	100 -	09/06→06/11					
	105						
120 d	130	03/07→06/11					
120 i	120 -	03/07→06/11					
	125						
123 d	150	03/07→06/11		09/08→ 05/11; für Fahrzeuge ohne Aktivlenkung		24.9145-0003.2 399007	
BMW - 1 (F20) 07/11→06/19							
 Hauptbremszylinder							
114 d	70	11/12→06/19		für Linkslenker		24.4123-1736.3 011118	Ø 23,8 ohne Bremsflüssigkeitsbehälter
116 d	85	07/11→02/15					
116 i	100	07/11→02/15					
118 d	100 -	07/11→06/19					
	105						
118 i	125	07/11→02/15					
120 d	120 -	07/11→06/19					
	147						
114 i	75	07/12→02/15		09/12→; für Linkslenker		24.4123-1736.3 011118	Ø 23,8 ohne Bremsflüssigkeitsbehälter
116 d	85	03/15→06/19		für Linkslenker; für Fahrzeuge ohne M-Sportbremse		24.4123-1736.3 011118	Ø 23,8 ohne Bremsflüssigkeitsbehälter
116 i	80	03/15→06/19					
118 d	110	03/15→06/19					
118 i	100	03/15→06/19		für Linkslenker; für Fahrzeuge mit M-Sportbremse		24.4125-1713.3 011109	Ø 25,4 ohne Bremsflüssigkeitsbehälter
120 d	140 -	03/15→06/19					
	151						
120 d xDrive	140 -	03/15→06/19					
	151						
120 i	130 -	03/15→06/19					
	135						
118 d xDrive	105 -	07/13→06/19		für Fahrzeuge ohne Start-Stopp-Funktion		24.4123-1736.3 011118	Ø 23,8 ohne Bremsflüssigkeitsbehälter
	110						
→							







	kw			 	! #		
BMW - 1 (F20) 07/11→06/19							
 Hauptbremszylinder							
120 d xDrive	135 - 147	11/12→02/15		für Fahrzeuge mit Start-Stopp-Funktion		24.4125-1713.3 011109	Ø 25,4 ohne Bremsflüssigkeitsbehälter
125 d	155 - 165	03/12→06/19		für Linkslenker		24.4125-1713.3 011109	Ø 25,4 ohne Bremsflüssigkeitsbehälter
125 i	160 - 175	03/12→06/19					
M 135 i	240	03/15→06/16					
M 140 i	250	07/16→06/19					
M 140 i xDrive	250	07/16→06/19					
M 135 i	235	07/12→02/15		09/12→; für Linkslenker		24.4125-1713.3 011109	Ø 25,4 ohne Bremsflüssigkeitsbehälter
M 135 i xDrive	235 - 240	11/12→06/16				24.4125-1713.3 011109	Ø 25,4 ohne Bremsflüssigkeitsbehälter
BMW - 1 (F21) 12/11→12/19							
 Hauptbremszylinder							
114 d	70	06/15→05/19		für Linkslenker		24.4123-1736.3 011118	Ø 23,8 ohne Bremsflüssigkeitsbehälter
116 d	85	12/11→02/15					
116 i	100	12/11→02/15					
118 d	100 - 105	12/11→06/19					
118 i	125	07/12→06/19					
120 d	120 - 147	01/12→06/19					
114 d	70	07/12→05/19		10/12→; für Linkslenker		24.4123-1736.3 011118	Ø 23,8 ohne Bremsflüssigkeitsbehälter
114 i	75	07/12→01/15		09/12→; für Linkslenker		24.4123-1736.3 011118	Ø 23,8 ohne Bremsflüssigkeitsbehälter
116 d	85	03/15→05/19		für Linkslenker; für Fahrzeuge ohne M-Sportbremse		24.4123-1736.3 011118	Ø 23,8 ohne Bremsflüssigkeitsbehälter
116 i	80	03/15→06/19					
118 d	110	03/15→06/19					
118 d xDrive	110	03/15→05/19		für Linkslenker; für Fahrzeuge mit M-Sportbremse		24.4125-1713.3 011109	Ø 25,4 ohne Bremsflüssigkeitsbehälter
118 i	100	03/15→06/19					
120 d	140 - 151	03/15→06/19					
120 d xDrive	140 - 151	03/15→06/19					
120 i	130 - 135	03/15→06/19					
118 d xDrive	105	05/13→02/15		für Fahrzeuge ohne Start-Stopp-Funktion		24.4123-1736.3 011118	Ø 23,8 ohne Bremsflüssigkeitsbehälter
				für Fahrzeuge mit Start-Stopp-Funktion		24.4125-1713.3 011109	Ø 25,4 ohne Bremsflüssigkeitsbehälter
120 d xDrive	135 - 147	01/12→02/15		07/12→; für Fahrzeuge ohne Start-Stopp-Funktion		24.4123-1736.3 011118	Ø 23,8 ohne Bremsflüssigkeitsbehälter
				07/12→; für Fahrzeuge mit Start-Stopp-Funktion		24.4125-1713.3 011109	Ø 25,4 ohne Bremsflüssigkeitsbehälter
125 d	155 - 160	12/11→05/19		03/12→; für Linkslenker		24.4125-1713.3 011109	Ø 25,4 ohne Bremsflüssigkeitsbehälter
125 i	160	12/11→12/19					
125 d	165	03/15→05/19		für Linkslenker		24.4125-1713.3 011109	Ø 25,4 ohne Bremsflüssigkeitsbehälter
125 i	165 - 175	03/13→06/19					
M 135 i	240	03/15→06/16					
M 140 i	250	10/15→06/19					
M 140 i xDrive	250	09/15→06/19					
M 135 i	235	12/11→06/16		09/12→; für Linkslenker		24.4125-1713.3 011109	Ø 25,4 ohne Bremsflüssigkeitsbehälter
M 135 i xDrive	235	02/12→06/16		07/12→		24.4125-1713.3 011109	Ø 25,4 ohne Bremsflüssigkeitsbehälter
M 135 i xDrive	240	03/15→06/16				24.4125-1713.3 011109	Ø 25,4 ohne Bremsflüssigkeitsbehälter
BMW - 1 (F40) 07/19→							
 Hauptbremszylinder							
116 d	85	07/19→		für Fahrzeuge ohne M-Sportbremse		24.4122-1722.3 011085	Ø 22,2 ohne Bremsflüssigkeitsbehälter
116 i	80	11/20→					
118 d	100 - 110	07/19→		für Fahrzeuge mit M-Sportbremse		24.4123-1733.3 011108	Ø 23,8 ohne Bremsflüssigkeitsbehälter
118 i	100 - 103	07/19→					
120 d	140	03/20→				24.4123-1733.3 011108	Ø 23,8 ohne Bremsflüssigkeitsbehälter
120 d xDrive	140	07/19→					
120 i	131	11/20→					
128 ti	180 - 195	11/20→					









	kw			 	! #		
BMW - 1 (F52) 01/17→							
 Hauptbremszylinder							
118 i	100	01/17→08/19		für Fahrzeuge ohne M-Sportbremse	24.4122-1722.3	011085	Ø 22,2 ohne Bremsflüssigkeitsbehälter
				für Fahrzeuge mit M-Sportbremse	24.4123-1733.3	011108	Ø 23,8 ohne Bremsflüssigkeitsbehälter
BMW - 1 Cabriolet (E88) 12/07→12/13							
 Bremskraftverstärker							
118 d	100 - 105	09/08→12/13		→ 10/13; für Fahrzeuge ohne Start-Stopp-Funktion	03.7848-4003.4	300235	ATE Ø 8" pneumatisch
118 i	100	09/08→12/13					
120 d	120 - 145	03/08→12/13					
120 i	115 - 120	03/08→12/13					
118 i	105	03/08→10/13		für Fahrzeuge ohne Start-Stopp-Funktion	03.7848-4003.4	300235	ATE Ø 8" pneumatisch
120 i	125	12/07→10/13					
128 i	172	12/07→10/13					
123 d	150	09/08→12/13		für Fahrzeuge ohne Start-Stopp-Funktion	03.7848-5003.4	300236	ATE Ø 8" pneumatisch
125 i	160	12/07→10/13			03.7848-4003.4	300235	ATE Ø 8" pneumatisch
135 i	225	03/08→10/13			03.7845-0103.4	300268	ATE Ø 8" pneumatisch
135 i	240	03/08→12/13		→ 10/13	03.7845-0103.4	300268	ATE Ø 8" pneumatisch
 Hauptbremszylinder							
118 d	100 - 105	09/08→12/13		→ 10/13; für Linkslenker	03.2023-2407.3	010796	ATE Ø1 23,8 Ø2 22,2
118 i	100	09/08→12/13					
120 d	120 - 145	03/08→12/13					
120 i	115 - 120	03/08→12/13					
118 i	105	03/08→10/13		für Linkslenker	03.2023-2407.3	010796	ATE Ø1 23,8 Ø2 22,2
120 i	125	12/07→10/13					
125 i	160	12/07→10/13					
128 i	172	12/07→10/13					
123 d	150	09/08→12/13		für Linkslenker	03.2025-1904.3	010797	ATE Ø1 25,4 Ø2 22,2
135 i	225	03/08→10/13					
135 i	240	03/08→12/13		→ 10/13; für Linkslenker	03.2025-1904.3	010797	ATE Ø1 25,4 Ø2 22,2
Hydraulikaggregat, Bremsanlage							
118 d	100 - 105	09/08→12/13		→ 10/13	24.9145-0003.2	399007	
118 i	100	09/08→12/13					
118 i	105	03/08→10/13		09/08→	24.9145-0003.2	399007	
120 d	120 - 145	03/08→12/13		09/08→ 10/13; für Fahrzeuge ohne Aktivlenkung	24.9145-0003.2	399007	
120 i	115 - 120	03/08→12/13					
120 i	125	12/07→10/13		09/08→; für Fahrzeuge ohne Aktivlenkung	24.9145-0003.2	399007	
123 d	150	09/08→12/13		für Fahrzeuge ohne Aktivlenkung	24.9145-0003.2	399007	
BMW - 1 Coupe (E82) 10/06→10/13							
 Bremskraftverstärker							
118 d	100 - 105	09/09→10/13		für Fahrzeuge ohne Start-Stopp-Funktion	03.7848-4003.4	300235	ATE Ø 8" pneumatisch
120 d	120 - 130	09/07→10/13					
120 i	115	09/09→10/13					
120 d	145	09/07→10/13		10/07→; für Fahrzeuge ohne Start-Stopp-Funktion	03.7848-4003.4	300235	ATE Ø 8" pneumatisch
120 i	125	10/07→10/13		09/09→; für Fahrzeuge ohne Start-Stopp-Funktion	03.7848-4003.4	300235	ATE Ø 8" pneumatisch
123 d	150	10/07→09/13		→ 08/09	03.7848-4003.4	300235	ATE Ø 8" pneumatisch
				09/09→; für Fahrzeuge ohne Start-Stopp-Funktion	03.7848-5003.4	300236	ATE Ø 8" pneumatisch
125 i	160	03/08→10/13			03.7848-4003.4	300235	ATE Ø 8" pneumatisch
128 i	172	10/07→10/13					
135 i	225 - 240	10/07→10/13			03.7845-0103.4	300268	ATE Ø 8" pneumatisch
 Hauptbremszylinder							
118 d	100 - 105	09/09→10/13		für Linkslenker	03.2023-2407.3	010796	ATE Ø1 23,8 Ø2 22,2
→							











	kw					! #		
BMW - 1 Coupe (E82) 10/06→10/13								
 Hauptbremszylinder								
120 d	120 - 130	09/07→10/13			für Linkslenker		03.2023-2407.3 010796	ATE Ø1 23,8 Ø2 22,2
120 i	115	09/09→10/13						
125 i	160	03/08→10/13						
128 i	172	10/07→10/13						
120 d	145	09/07→10/13			10/07→; für Linkslenker		03.2023-2407.3 010796	ATE Ø1 23,8 Ø2 22,2
120 i	125	10/07→10/13			09/09→; für Linkslenker		03.2023-2407.3 010796	ATE Ø1 23,8 Ø2 22,2
123 d	150	10/07→09/13			für Linkslenker		03.2025-1904.3 010797	ATE Ø1 25,4 Ø2 22,2
135 i	225 - 240	10/07→10/13						
Hydraulikaggregat, Bremsanlage								
118 d	100 - 105	09/09→10/13					24.9145-0003.2 399007	
120 d	120 - 145	09/07→10/13			09/08→; für Fahrzeuge ohne Aktivlenkung		24.9145-0003.2 399007	
123 d	150	10/07→09/13						
120 i	115	09/09→10/13			für Fahrzeuge ohne Aktivlenkung		24.9145-0003.2 399007	
120 i	125	10/07→10/13			09/09→; für Fahrzeuge ohne Aktivlenkung		24.9145-0003.2 399007	
BMW - 1 Van (F20) 03/15→06/19								
 Hauptbremszylinder								
118 d	110	03/15→06/19			für Linkslenker; für Fahrzeuge ohne M-Sportbremse		24.4123-1736.3 011118	Ø 23,8 ohne Bremsflüssigkeitsbehälter
118 i	100	07/15→06/19						
120 d	140	03/15→06/19			für Linkslenker; für Fahrzeuge mit M-Sportbremse		24.4125-1713.3 011109	Ø 25,4 ohne Bremsflüssigkeitsbehälter
120 i	135	07/16→06/19						
M 140 i	250	07/16→06/19			für Linkslenker		24.4125-1713.3 011109	Ø 25,4 ohne Bremsflüssigkeitsbehälter
BMW - 2 Active Tourer (F45) 11/13→10/21								
 Hauptbremszylinder								
214 d	70	07/14→02/18			03/15→		24.4122-1722.3 011085	Ø 22,2 ohne Bremsflüssigkeitsbehälter
216 d	85	03/14→10/21			10/14→		24.4122-1722.3 011085	Ø 22,2 ohne Bremsflüssigkeitsbehälter
218 i	100	07/14→10/21						
220 d xDrive	140	03/14→10/21						
220 i	141	03/14→10/21						
216 i	75	02/15→02/18			11/15→		24.4122-1722.3 011085	Ø 22,2 ohne Bremsflüssigkeitsbehälter
218 d xDrive	100 - 110	12/14→10/21						
216 i	80	03/18→10/21					24.4122-1722.3 011085	Ø 22,2 ohne Bremsflüssigkeitsbehälter
218 d	110	11/13→10/21						
220 d	140	03/14→10/21						
220 i	131	11/20→10/21						
218 d	100	11/13→10/21			09/14→		24.4122-1722.3 011085	Ø 22,2 ohne Bremsflüssigkeitsbehälter
218 i	103	03/18→10/21					24.4123-1733.3 011108	Ø 23,8 ohne Bremsflüssigkeitsbehälter
225 xe Plug-in-Hybrid	162	11/20→10/21						
220 d	120	03/14→10/21			11/14→		24.4122-1722.3 011085	Ø 22,2 ohne Bremsflüssigkeitsbehälter
220 d xDrive	120	03/14→10/21						
220 i	120	03/14→10/21						
225 i	170	11/13→12/19			10/14→		24.4123-1733.3 011108	Ø 23,8 ohne Bremsflüssigkeitsbehälter
225 i xDrive	170	03/14→10/21						
225 xe Plug-in-Hybrid	165	11/14→10/21			03/16→		24.4123-1733.3 011108	Ø 23,8 ohne Bremsflüssigkeitsbehälter
BMW - 2 Active Tourer Van (F45) 11/13→10/21								
 Hauptbremszylinder								
218 d	110	07/14→10/21					24.4122-1722.3 011085	Ø 22,2 ohne Bremsflüssigkeitsbehälter
220 d	140	11/14→10/21						
218 i	103	03/18→10/21					24.4123-1733.3 011108	Ø 23,8 ohne Bremsflüssigkeitsbehälter
BMW - 2 Cabriolet (F23) 03/14→06/21								
 Hauptbremszylinder								
218 d	100 - 110	07/15→09/20			für Linkslenker; - Performance Parts		24.4123-1736.3 011118	Ø 23,8 ohne Bremsflüssigkeitsbehälter
218 i	100	03/15→06/21						
220 i	135	09/15→06/21			für Linkslenker; + Performance Parts		24.4125-1713.3 011109	Ø 25,4 ohne Bremsflüssigkeitsbehälter
225 i	135	10/17→06/21						
230 i	185	07/16→06/21						
→								











	kw			 	! #		
BMW - 2 Cabriolet (F23) 03/14→06/21							
 Hauptbremszylinder							
220 d	120 - 151	03/14→09/20		11/14→; für Linkslenker		24.4125-1713.3 011109	Ø 25,4 ohne Bremsflüssigkeitsbehälter
220 i	135	04/14→06/21		11/14→; für Linkslenker; - Performance Parts		24.4123-1736.3 011118	Ø 23,8 ohne Bremsflüssigkeitsbehälter
				11/14→; für Linkslenker; + Performance Parts		24.4125-1713.3 011109	Ø 25,4 ohne Bremsflüssigkeitsbehälter
225 d 228 i M 235 i M 235 i xDrive M 240 i M 240 i xDrive	165 180 240 240 250 250	07/15→05/19 11/14→06/16 11/14→06/16 07/15→06/16 09/15→06/21 09/15→06/21		für Linkslenker		24.4125-1713.3 011109	Ø 25,4 ohne Bremsflüssigkeitsbehälter
BMW - 2 Coupe (F22, F87) 10/12→06/21							
 Hauptbremszylinder							
218 d	100	03/14→09/20		07/15→; für Linkslenker; - Performance Parts		24.4123-1736.3 011118	Ø 23,8 ohne Bremsflüssigkeitsbehälter
				07/15→; für Linkslenker; + Performance Parts		24.4125-1713.3 011109	Ø 25,4 ohne Bremsflüssigkeitsbehälter
218 d	105 - 110	03/14→09/20		für Linkslenker; - Performance Parts		24.4123-1736.3 011118	Ø 23,8 ohne Bremsflüssigkeitsbehälter
218 i 220 d	100 120 - 135	03/15→06/21 10/13→09/20		für Linkslenker; + Performance Parts		24.4125-1713.3 011109	Ø 25,4 ohne Bremsflüssigkeitsbehälter
220 i	135	10/13→06/21					
225 i 230 i	135 185	10/17→06/21 07/16→06/21					
220 d	140 - 151	03/14→09/20		11/14→; für Linkslenker		24.4125-1713.3 011109	Ø 25,4 ohne Bremsflüssigkeitsbehälter
220 d	147	10/12→11/14		10/13→; für Linkslenker; - Performance Parts		24.4123-1736.3 011118	Ø 23,8 ohne Bremsflüssigkeitsbehälter
				10/13→; für Linkslenker; + Performance Parts		24.4125-1713.3 011109	Ø 25,4 ohne Bremsflüssigkeitsbehälter
220 d xDrive 225 d	120 160 - 165	03/15→09/20 01/14→05/19		für Linkslenker		24.4125-1713.3 011109	Ø 25,4 ohne Bremsflüssigkeitsbehälter
228 i M 235 i M 240 i M 240 i xDrive	180 240 250 250	07/14→06/16 10/13→06/16 09/15→06/21 09/15→06/21					
220 d xDrive	140 - 151	06/14→09/20		03/15→; für Linkslenker		24.4125-1713.3 011109	Ø 25,4 ohne Bremsflüssigkeitsbehälter
M 235 i xDrive	240	07/14→06/16				24.4125-1713.3 011109	Ø 25,4 ohne Bremsflüssigkeitsbehälter
BMW - 2 Gran Coupe (F44) 11/19→							
 Hauptbremszylinder							
216 d 218 i	85 100 - 103	03/20→ 11/19→		für Fahrzeuge ohne M-Sportbremse		24.4122-1722.3 011085	Ø 22,2 ohne Bremsflüssigkeitsbehälter
				für Fahrzeuge mit M-Sportbremse		24.4123-1733.3 011108	Ø 23,8 ohne Bremsflüssigkeitsbehälter
218 d 220 d	100 - 110 120 - 140	11/19→ 11/19→				24.4123-1733.3 011108	Ø 23,8 ohne Bremsflüssigkeitsbehälter
220 d xDrive 220 i 220 i xDrive	140 131 131	07/20→ 11/20→ 03/21→					
BMW - 2 Gran Tourer (F46) 07/14→							
 Hauptbremszylinder							
214 d 216 d 218 d 218 d xDrive	70 85 110 100 - 110	07/15→02/18 03/15→ 07/14→ 03/15→				24.4122-1722.3 011085	Ø 22,2 ohne Bremsflüssigkeitsbehälter
218 i	100	03/15→				24.4123-1733.3 011108	Ø 23,8 ohne Bremsflüssigkeitsbehälter
216 i	75	09/14→02/18		07/15→		24.4122-1722.3 011085	Ø 22,2 ohne Bremsflüssigkeitsbehälter
						24.4123-1733.3 011108	Ø 23,8 ohne Bremsflüssigkeitsbehälter
216 i 220 d →	80 140	03/18→ 09/14→				24.4123-1733.3 011108	Ø 23,8 ohne Bremsflüssigkeitsbehälter











	kw			 	! #		
BMW - 2 Gran Tourer (F46) 07/14→							
 Hauptbremszylinder							
220 d xDrive	120 - 140	03/15→				24.4123-1733.3 011108	Ø 23,8 ohne Bremsflüssigkeitsbehälter
220 i	120 - 141	03/15→					
218 d	100	07/14→		03/15→		24.4122-1722.3 011085 24.4123-1733.3 011108	Ø 22,2 ohne Bremsflüssigkeitsbehälter Ø 23,8 ohne Bremsflüssigkeitsbehälter
218 i	103	04/17→		nicht für Fahrzeuge mit verstärkter Bremse		24.4123-1733.3 011108	Ø 23,8 ohne Bremsflüssigkeitsbehälter
220 d	120	09/14→		07/15→		24.4123-1733.3 011108	Ø 23,8 ohne Bremsflüssigkeitsbehälter
BMW - 2 Gran Tourer Van (F46) 07/14→							
 Hauptbremszylinder							
218 d	110	07/14→				24.4122-1722.3 011085 24.4123-1733.3 011108	Ø 22,2 ohne Bremsflüssigkeitsbehälter Ø 23,8 ohne Bremsflüssigkeitsbehälter
218 i	103	04/17→		nicht für Fahrzeuge mit verstärkter Bremse		24.4123-1733.3 011108	Ø 23,8 ohne Bremsflüssigkeitsbehälter
220 d	140	07/14→				24.4123-1733.3 011108	Ø 23,8 ohne Bremsflüssigkeitsbehälter
BMW - 3 (E46) 12/97→05/05							
 Bremskraftverstärker							
316 i	77 - 85	12/98→02/05				03.7860-0702.4 300123	ATE Ø 10" pneumatisch
318 d	85	09/01→02/05					
318 i	87 - 105	12/97→02/05					
320 d	95 - 110	02/98→05/05					
320 i	110 - 125	03/98→02/05					
323 i	120 - 125	03/98→09/00					
325 i	141	09/00→02/05					
325 xi	141	09/00→02/05					
328 i	142	02/98→06/00					
330 d	135 - 150	10/99→02/05					
330 i	170	06/00→02/05					
330 xi	170	06/00→02/05					
330 xd	135	01/00→02/03		06/00→		03.7860-0702.4 300123	ATE Ø 10" pneumatisch
330 xd	150	09/02→12/04		03/03→		03.7860-0702.4 300123	ATE Ø 10" pneumatisch
 Hauptbremszylinder							
316 i	77	12/98→02/05		→ 08/01; - DSC		03.2022-2624.3 010588	Ø1 22,2 Ø2 20,6
320 i	120 - 125	09/00→02/05		02/01→; + DSC		03.2023-2256.3 010870	ATE Ø1 23,8 Ø2 22,2
325 i	141	09/00→02/05		09/01→; - DSC		03.2023-2344.3 010647	ATE Ø1 23,8 Ø2 22,2
316 i	85	02/02→02/05		+ DSC		03.2023-2256.3 010870	ATE Ø1 23,8 Ø2 22,2
318 d	85	09/01→02/05		- DSC		03.2023-2344.3 010647	ATE Ø1 23,8 Ø2 22,2
318 i	100 - 105	09/01→02/05					
320 d	110	09/01→05/05					
318 i	87	12/97→09/01		- DSC		03.2022-2624.3 010588	Ø1 22,2 Ø2 20,6
320 i	110	03/98→09/00					
323 i	120 - 125	03/98→09/00					
328 i	142	02/98→06/00					
320 d	95 - 100	02/98→09/01		- DSC		03.2022-2624.3 010588	Ø1 22,2 Ø2 20,6
				02/01→; + DSC		03.2023-2256.3 010870	ATE Ø1 23,8 Ø2 22,2
330 d	135	10/99→02/05		→ 08/00; + DSC		03.2023-2204.3 010644	ATE Ø1 23,8 Ø2 22,2
330 i	170	06/00→02/05		02/01→; + DSC		03.2023-2256.3 010870	ATE Ø1 23,8 Ø2 22,2
				→ 08/01; - DSC		03.2023-2304.3 010646	ATE Ø1 23,8 Ø2 22,2
				09/01→; - DSC		03.2023-2344.3 010647	ATE Ø1 23,8 Ø2 22,2
330 d	150	03/03→02/05		+ DSC		03.2023-2256.3 010870	ATE Ø1 23,8 Ø2 22,2







	kW			 	! #		
BMW - 3 (E90) 02/04→02/12							
Bremskraftverstärker							
316 d 316 i 318 d 318 i 320 i	85 90 100 95 - 105 110 - 125	07/09→12/11 09/07→10/11 09/07→10/11 09/05→10/11 12/04→10/11		für Fahrzeuge ohne Start-Stopp-Funktion		03.7848-4003.4 300235	ATE Ø 8" pneumatisch
316 i 320 i	85 115	09/05→10/11 02/07→12/11		→ 08/07; für Fahrzeuge ohne Start-Stopp-Funktion		03.7848-4003.4 300235	ATE Ø 8" pneumatisch
318 d	90	03/05→08/07		09/05→; für Fahrzeuge ohne Start-Stopp-Funktion		03.7848-4003.4 300235	ATE Ø 8" pneumatisch
318 d 320 i	105 120	02/07→10/11 03/07→12/11		09/07→; für Fahrzeuge ohne Start-Stopp-Funktion		03.7848-4003.4 300235	ATE Ø 8" pneumatisch
320 d	110 - 115	12/04→09/07		09/05→; für Fahrzeuge ohne Start-Stopp-Funktion		03.7845-0103.4 300268	ATE Ø 8" pneumatisch
320 d 320 si 323 i 325 d 325 i 325 xi 328 i 330 d 330 i 330 i xDrive 330 xd 330 xi	120 127 130 - 140 145 - 150 155 - 160 160 172 155 - 170 190 200 170 190 - 200	12/04→10/11 09/05→08/06 09/05→12/11 09/06→10/11 12/04→12/11 09/05→08/06 09/06→12/11 09/05→12/11 12/04→10/11 09/08→10/11 09/05→08/08 09/05→08/08 200				03.7848-5003.4 300236	ATE Ø 8" pneumatisch
320 d 320 d xDrive 335 d 335 i 335 i xDrive 335 xi	130 - 135 120 - 135 210 225 224 - 240 225 - 240	09/07→10/11 09/08→10/11 09/06→12/11 09/06→12/11 05/08→10/11 09/06→08/08		für Fahrzeuge ohne Start-Stopp-Funktion		03.7845-0103.4 300268	ATE Ø 8" pneumatisch
325 i xDrive	155 - 160	09/08→10/11		Motorcode: N53		03.7848-5003.4 300236	ATE Ø 8" pneumatisch
325 xi	160	09/05→08/08		→ 08/07; Motorcode: N52N; für Fahrzeuge ohne Start-Stopp-Funktion		03.7845-0103.4 300268	ATE Ø 8" pneumatisch
				→ 08/07; Motorcode: N52		03.7848-5003.4 300236	ATE Ø 8" pneumatisch
				09/07→; Motorcode: N53		03.7848-5003.4 300236	ATE Ø 8" pneumatisch
325 xi	160	09/07→08/08		Motorcode: N52N; für Fahrzeuge ohne Start-Stopp-Funktion		03.7845-0103.4 300268	ATE Ø 8" pneumatisch
				Motorcode: N53		03.7848-5003.4 300236	ATE Ø 8" pneumatisch
330 d 330 d xDrive 330 i	180 180 200	09/08→10/11 09/08→10/11 03/07→12/11		→ 08/09; für Fahrzeuge ohne Start-Stopp-Funktion		03.7845-0103.4 300268	ATE Ø 8" pneumatisch
				09/09→		03.7848-5003.4 300236	ATE Ø 8" pneumatisch
335 i	220 - 240	03/06→12/11		09/06→; für Fahrzeuge ohne Start-Stopp-Funktion		03.7845-0103.4 300268	ATE Ø 8" pneumatisch
335 xi	224	09/06→06/08		03/07→; für Fahrzeuge ohne Start-Stopp-Funktion		03.7845-0103.4 300268	ATE Ø 8" pneumatisch
Hauptbremszylinder							
316 d 316 i 318 d 318 i 320 i	85 90 100 95 - 105 110 - 125	07/09→12/11 09/07→10/11 09/07→10/11 09/05→10/11 12/04→12/11		für Linkslenker		03.2023-2407.3 010796	ATE Ø1 23,8 Ø2 22,2
316 i 320 i	85 115	09/05→10/11 02/07→12/11		→ 08/07; für Linkslenker		03.2023-2407.3 010796	ATE Ø1 23,8 Ø2 22,2
318 d	90	03/05→08/07		09/05→; für Linkslenker		03.2023-2407.3 010796	ATE Ø1 23,8 Ø2 22,2
318 d	105	02/07→10/11		09/07→; für Linkslenker		03.2023-2407.3 010796	ATE Ø1 23,8 Ø2 22,2
320 d	110 - 115	12/04→09/07		09/05→; für Linkslenker		03.2025-1904.3 010797	ATE Ø1 25,4 Ø2 22,2
320 d 320 si 323 i	120 - 135 127 130 - 140	12/04→10/11 09/05→08/06 09/05→12/11		für Linkslenker		03.2025-1904.3 010797	ATE Ø1 25,4 Ø2 22,2
→							









	kw			 	! #		
BMW - 3 (E90) 02/04→02/12							
 Hauptbremszylinder							
325 i	155 - 160	12/04→12/11		für Linkslenker		03.2025-1904.3 010797	ATE Ø1 25,4 Ø2 22,2
328 i	172	09/06→12/11					
330 d	180	09/08→10/11					
330 i	190 - 200	12/04→12/11					
335 i	225	09/06→12/11					
320 d xDrive	120 - 135	09/08→10/11				03.2025-1904.3 010797	ATE Ø1 25,4 Ø2 22,2
325 d	145 - 150	09/06→10/11					
325 i xDrive	155 - 160	09/08→10/11					
325 xi	160	09/05→08/08					
330 d	155 - 170	09/05→12/11					
330 d xDrive	180	09/08→10/11					
330 i xDrive	200	09/08→10/11					
330 xd	170	09/05→08/08					
330 xi	190 - 200	09/05→08/08					
335 d	210	09/06→12/11					
335 i xDrive	224 - 240	05/08→10/11					
335 xi	224 - 225	09/06→08/08					
335 i	220 - 240	03/06→12/11		09/06→; für Linkslenker		03.2025-1904.3 010797	ATE Ø1 25,4 Ø2 22,2
335 xi	240	09/06→06/08		03/07→		03.2025-1904.3 010797	ATE Ø1 25,4 Ø2 22,2
Hydraulikaggregat, Bremsanlage							
316 d	85	07/09→12/11				24.9145-0003.2 399007	
316 i	90	09/07→10/11		09/08→		24.9145-0003.2 399007	
318 d	100 - 105	02/07→10/11					
318 i	100 - 105	09/07→10/11					
320 d	120 - 130	12/04→10/11		09/08→; für Fahrzeuge ohne Aktivlenkung		24.9145-0003.2 399007	
320 i	120 - 125	03/07→12/11					
320 d	135	03/10→10/11		für Fahrzeuge ohne Aktivlenkung		24.9145-0003.2 399007	
BMW - 3 (F30, F80) 11/11→10/18							
 Hauptbremszylinder							
316 d	85	03/12→10/18		für Linkslenker		24.4123-1736.3 011118	Ø 23,8 ohne Bremsflüssigkeitsbehälter
318 d	100 - 110	03/12→10/18					
318 d xDrive	110	07/15→02/18					
320 d xDrive	140	07/15→10/18					
320 i	125 - 135	03/12→10/18					
320 i xDrive	135	07/12→10/18					
316 i	100	07/12→08/16		11/12→; für Linkslenker		24.4123-1736.3 011118	Ø 23,8 ohne Bremsflüssigkeitsbehälter
318 d xDrive	105	07/13→06/15		für Linkslenker; - Performance Parts		24.4123-1736.3 011118	Ø 23,8 ohne Bremsflüssigkeitsbehälter
318 i	100	07/15→10/18		für Linkslenker; + Performance Parts		24.4125-1713.3 011109	Ø 25,4 ohne Bremsflüssigkeitsbehälter
320 d	120	11/11→10/18		02/12→; für Linkslenker		24.4123-1736.3 011118	Ø 23,8 ohne Bremsflüssigkeitsbehälter
320 d	135 - 147	11/11→03/16		02/12→; für Linkslenker		24.4125-1713.3 011109	Ø 25,4 ohne Bremsflüssigkeitsbehälter
328i	160	11/11→06/15					
328 i	180	11/11→10/18					
335 i	225 - 240	11/11→07/15					
320 d	140	07/15→10/18		für Linkslenker; für Fahrzeuge ohne M-Sportbremse		24.4125-1713.3 011109	Ø 25,4 ohne Bremsflüssigkeitsbehälter
320 d xDrive	120 - 147	08/12→10/18		für Linkslenker		24.4125-1713.3 011109	Ø 25,4 ohne Bremsflüssigkeitsbehälter
325 d	165	03/16→02/18					
328 i xDrive	180	07/12→08/16					
330 d	190	07/12→10/18					
330 d xDrive	190	03/13→10/18					
335 d xDrive	230	07/13→10/18					
335 i	250	07/13→07/15					
→							











	kw				! #		
BMW - 3 (F30, F80) 11/11→10/18							
 Hauptbremszylinder							
335 i xDrive ActiveHybrid	225 - 250 250	07/12→07/15 07/12→06/15		für Linkslenker		24.4125-1713.3 011109	Ø 25,4 ohne Bremsflüssigkeitsbehälter
325 d	155 - 160	03/13→02/16		04/13→; für Linkslenker		24.4125-1713.3 011109	Ø 25,4 ohne Bremsflüssigkeitsbehälter
330 d 330 d xDrive	210 210	07/12→10/18 03/13→10/18		09/15→; für Linkslenker		24.4125-1713.3 011109	Ø 25,4 ohne Bremsflüssigkeitsbehälter
330 e	185	11/15→10/18		01/16→; für Linkslenker		24.4125-1713.3 011109	Ø 25,4 ohne Bremsflüssigkeitsbehälter
330 i 330 i xDrive 340 i 340 i xDrive	185 185 240 - 265 240 - 265	07/15→10/18 07/15→10/18 07/15→10/18 07/15→10/18		für Linkslenker; - Performance Parts		24.4125-1713.3 011109	Ø 25,4 ohne Bremsflüssigkeitsbehälter
BMW - 3 Cabriolet (E46) 04/00→12/07							
 Bremskraftverstärker							
318 Ci	100	12/00→08/06		09/01→		03.7860-0702.4 300123	ATE Ø 10" pneumatisch
318 Ci 320 Cd 320 Ci	105 110 120 - 125	09/01→12/07 02/05→12/07 09/00→12/07		→ 09/06		03.7860-0702.4 300123	ATE Ø 10" pneumatisch
330 Cd	150	08/05→12/07					
318 Ci 323 Ci	110 120 - 125	03/04→08/06 04/00→09/00				03.7860-0702.4 300123	ATE Ø 10" pneumatisch
325 Ci 330 Ci	141 170	09/00→08/06 06/00→08/06					
 Hauptbremszylinder							
318 Ci	100	12/00→08/06		09/01→; + DSC 09/01→; - DSC		03.2023-2256.3 010870 03.2023-2344.3 010647	ATE Ø1 23,8 Ø2 22,2
318 Ci 320 Ci	105 120	09/01→12/07 01/06→12/07		→ 09/06; + DSC → 09/06; - DSC		03.2023-2256.3 010870 03.2023-2344.3 010647	ATE Ø1 23,8 Ø2 22,2
318 Ci	110	03/04→08/06				03.2023-2256.3 010870	ATE Ø1 23,8 Ø2 22,2
320 Cd 330 Cd	110 150	02/05→12/07 08/05→12/07		→ 09/06		03.2023-2256.3 010870	ATE Ø1 23,8 Ø2 22,2
320 Ci	125	09/00→12/07		→ 08/01; - DSC → 09/06; + DSC 09/01→ 09/06; - DSC		03.2022-2624.3 010588 03.2023-2256.3 010870 03.2023-2344.3 010647	Ø1 22,2 Ø2 20,6 ATE Ø1 23,8 Ø2 22,2 ATE Ø1 23,8 Ø2 22,2
323 Ci	120 - 125	04/00→09/00		- DSC		03.2022-2624.3 010588	Ø1 22,2 Ø2 20,6
325 Ci	141	09/00→08/06		→ 08/01; - DSC + DSC 09/01→; - DSC		03.2022-2624.3 010588 03.2023-2256.3 010870 03.2023-2344.3 010647	Ø1 22,2 Ø2 20,6 ATE Ø1 23,8 Ø2 22,2 ATE Ø1 23,8 Ø2 22,2
330 Ci	170	06/00→08/06		→ 08/00; + DSC 09/00→; + DSC → 08/01; - DSC 09/01→; - DSC		03.2023-2204.3 010644 03.2023-2256.3 010870 03.2023-2304.3 010646 03.2023-2344.3 010647	ATE Ø1 23,8 Ø2 22,2 ATE Ø1 23,8 Ø2 22,2 ATE Ø1 23,8 Ø2 22,2 ATE Ø1 23,8 Ø2 22,2
BMW - 3 Cabriolet (E93) 05/06→12/13							
 Bremskraftverstärker							
318 i	105	03/10→12/13		→ 11/13; für Fahrzeuge ohne Start-Stopp-Funktion		03.7848-4003.4 300235	ATE Ø 8" pneumatisch
320 d	120	01/08→12/13		→ 11/13; für Fahrzeuge ohne Start-Stopp-Funktion		03.7845-0103.4 300268	ATE Ø 8" pneumatisch
320 d	130 - 147	03/08→10/13		für Fahrzeuge ohne Start-Stopp-Funktion		03.7845-0103.4 300268	ATE Ø 8" pneumatisch
320 d	145	09/07→02/10		03/08→; für Fahrzeuge ohne Start-Stopp-Funktion		03.7845-0103.4 300268	ATE Ø 8" pneumatisch
320 i	115 - 120	09/06→10/13		03/07→ 03/08; Motorcode: N43 04/08→; für Fahrzeuge ohne Start-Stopp-Funktion 03/07→ 03/08; Motorcode: N46N		03.7845-0103.4 300268 03.7848-4003.4 300235 03.7848-5003.4 300236	ATE Ø 8" pneumatisch ATE Ø 8" pneumatisch ATE Ø 8" pneumatisch
320 i	125	03/07→10/13		→ 03/08; Motorcode: N43 04/08→; für Fahrzeuge ohne Start-Stopp-Funktion → 03/08; Motorcode: N46N		03.7845-0103.4 300268 03.7848-4003.4 300235 03.7848-5003.4 300236	ATE Ø 8" pneumatisch ATE Ø 8" pneumatisch ATE Ø 8" pneumatisch
323 i	140	03/07→09/11				03.7845-0103.4 300268	ATE Ø 8" pneumatisch
→							









	kw			 	! #		
BMW - 3 Cabriolet (E93) 05/06→12/13							
 Bremskraftverstärker							
325 d	145 - 155	03/07→12/10		09/07→		03.7848-5003.4 300236	ATE Ø 8" pneumatisch
325 d	150	09/09→09/13		03/10→		03.7848-5003.4 300236	ATE Ø 8" pneumatisch
325 i	160	12/06→02/10		Motorcode: N52N		03.7845-0103.4 300268	ATE Ø 8" pneumatisch
				Motorcode: N53		03.7848-5003.4 300236	ATE Ø 8" pneumatisch
325 i	155	10/06→12/13		03/07→; Motorcode: N52N; → 11/13		03.7845-0103.4 300268	ATE Ø 8" pneumatisch
				03/07→; Motorcode: N53; → 11/13		03.7848-5003.4 300236	ATE Ø 8" pneumatisch
325 i	160	03/07→12/13		Motorcode: N52N; → 11/13		03.7845-0103.4 300268	ATE Ø 8" pneumatisch
				Motorcode: N53; → 11/13		03.7848-5003.4 300236	ATE Ø 8" pneumatisch
330 d	170	03/07→12/13		→ 08/09		03.7845-0103.4 300268	ATE Ø 8" pneumatisch
				09/09→ 11/13		03.7848-5003.4 300236	ATE Ø 8" pneumatisch
330 d	180	01/09→09/13		→ 08/09		03.7845-0103.4 300268	ATE Ø 8" pneumatisch
				09/09→		03.7848-5003.4 300236	ATE Ø 8" pneumatisch
330 i	190	03/10→10/13				03.7848-5003.4 300236	ATE Ø 8" pneumatisch
330 i	200	03/07→10/13		→ 08/09; Motorcode: N53		03.7845-0103.4 300268	ATE Ø 8" pneumatisch
				Motorcode: N52N		03.7848-5003.4 300236	ATE Ø 8" pneumatisch
				09/09→; Motorcode: N53		03.7848-5003.4 300236	ATE Ø 8" pneumatisch
335 i	225 - 240	05/06→10/13		03/07→		03.7845-0103.4 300268	ATE Ø 8" pneumatisch
 Hauptbremszylinder							
318 i	105	03/10→12/13		→ 11/13		03.2023-2407.3 010796	ATE Ø1 23,8 Ø2 22,2
320 d	120	01/08→12/13		für Linkslenker; → 11/13		03.2025-1904.3 010797	ATE Ø1 25,4 Ø2 22,2
325 i	160	03/07→12/13					
330 d	170	03/07→12/13					
320 d	130 - 147	09/07→10/13		für Linkslenker		03.2025-1904.3 010797	ATE Ø1 25,4 Ø2 22,2
325 i	160	12/06→02/10					
330 d	180	01/09→09/13					
330 i	190 - 200	03/07→10/13					
320 i	115 - 120	09/06→10/13		06/08→; für Linkslenker		03.2023-2407.3 010796	ATE Ø1 23,8 Ø2 22,2
				03/07→; für Linkslenker; → 05/08		03.2025-1904.3 010797	ATE Ø1 25,4 Ø2 22,2
320 i	125	03/07→10/13		06/08→; für Linkslenker		03.2023-2407.3 010796	ATE Ø1 23,8 Ø2 22,2
				für Linkslenker; → 05/08		03.2025-1904.3 010797	ATE Ø1 25,4 Ø2 22,2
325 d	145 - 155	03/07→12/10		09/07→; für Linkslenker		03.2025-1904.3 010797	ATE Ø1 25,4 Ø2 22,2
325 d	150	09/09→09/13		03/10→; für Linkslenker		03.2025-1904.3 010797	ATE Ø1 25,4 Ø2 22,2
325 i	155	10/06→12/13		03/07→; für Linkslenker; → 11/13		03.2025-1904.3 010797	ATE Ø1 25,4 Ø2 22,2
335 i	225 - 240	05/06→10/13		03/07→; für Linkslenker		03.2025-1904.3 010797	ATE Ø1 25,4 Ø2 22,2
Hydraulikaggregat, Bremsanlage							
318 i	105	03/10→12/13		→ 11/13		24.9145-0003.2 399007	
320 d	120	01/08→12/13		09/08→ 11/13; für Fahrzeuge ohne Aktivlenkung		24.9145-0003.2 399007	
320 d	130 - 145	09/07→02/10		09/08→; für Fahrzeuge ohne Aktivlenkung		24.9145-0003.2 399007	
320 i	115 - 125	09/06→10/13					
320 d	135 - 147	03/10→10/13		für Fahrzeuge ohne Aktivlenkung		24.9145-0003.2 399007	
BMW - 3 Compact (E36) 01/94→08/00							
 Bremskraftverstärker							
316 g	75	02/96→08/00				03.7760-3102.4 300139	ATE Ø 10" pneumatisch
316 i	77	01/99→08/00					
318 tds	66	06/95→08/00					
323 ti	120 - 125	09/97→08/00					
316 i	75	01/94→08/00		09/96→; + ABS		03.7760-3102.4 300139	ATE Ø 10" pneumatisch
				→ 08/96; + ABS		10.6360-1903.4 300093	ATE Ø 10" pneumatisch
Pedalwegsensoren, Bremspedal							
316 i	75	01/94→08/00		→ 08/96; + ABS		03.0655-0002.2 370002	ATE
 Hauptbremszylinder							
316 i	75	01/94→08/00		→ 08/94; + ABS		10.6123-0239.3 010335	ATE Ø 23,8
				- ABS		24.2023-1601.3 010341	TRW Ø 23,8











	kw					! #		
BMW - 3 Compact (E46) 03/01→02/05								
 Bremskraftverstärker								
316 ti	77 - 85	06/01→02/05					03.7860-0702.4 300123	ATE Ø 10" pneumatisch
318 td	85	03/03→02/05						
320 td	100 - 110	09/01→02/05						
325 ti	141	04/01→12/04						
318 ti	100 - 105	03/01→12/04		09/01→			03.7860-0702.4 300123	ATE Ø 10" pneumatisch
 Hauptbremszylinder								
316 ti	77 - 85	06/02→02/05		+ DSC			03.2023-2256.3 010870	ATE Ø1 23,8 Ø2 22,2
320 td	100 - 110	09/01→02/05		- DSC			03.2023-2344.3 010647	ATE Ø1 23,8 Ø2 22,2
316 ti	85	06/01→02/05		→ 08/01; - DSC			03.2022-2624.3 010588	Ø1 22,2 Ø2 20,6
325 ti	141	04/01→12/04		09/01→; + DSC			03.2023-2256.3 010870	ATE Ø1 23,8 Ø2 22,2
				09/01→; - DSC			03.2023-2344.3 010647	ATE Ø1 23,8 Ø2 22,2
318 td	85	03/03→02/05		+ DSC			03.2023-2256.3 010870	ATE Ø1 23,8 Ø2 22,2
318 ti	100 - 105	03/01→12/04		09/01→; + DSC			03.2023-2256.3 010870	ATE Ø1 23,8 Ø2 22,2
				09/01→; - DSC			03.2023-2344.3 010647	ATE Ø1 23,8 Ø2 22,2
BMW - 3 Coupe (E46) 12/98→07/06								
 Bremskraftverstärker								
316 Ci	77 - 85	04/00→07/06					03.7860-0702.4 300123	ATE Ø 10" pneumatisch
318 Ci	85 - 110	12/99→05/06						
320 Cd	110	11/03→07/06						
323 Ci	120 - 125	04/99→09/00						
325 Ci	141	09/00→05/06						
328 Ci	142	12/98→05/00						
330 Cd	150	03/03→07/06						
330 Ci	170	06/00→05/06						
330 xi	170	06/00→07/06						
318 Ci	100	12/00→05/06		09/01→			03.7860-0702.4 300123	ATE Ø 10" pneumatisch
320 Ci	110	02/99→08/01		08/99→ 09/00			03.7860-0702.4 300123	ATE Ø 10" pneumatisch
320 Ci	120 - 125	01/00→05/06		09/00→			03.7860-0702.4 300123	ATE Ø 10" pneumatisch
 Hauptbremszylinder								
316 Ci	77	04/00→07/06		→ 08/01; - DSC			03.2022-2624.3 010588	Ø1 22,2 Ø2 20,6
				02/01→; + DSC			03.2023-2256.3 010870	ATE Ø1 23,8 Ø2 22,2
				09/01→; - DSC			03.2023-2344.3 010647	ATE Ø1 23,8 Ø2 22,2
316 Ci	85	06/02→07/06		+ DSC			03.2023-2256.3 010870	ATE Ø1 23,8 Ø2 22,2
318 Ci	105	09/01→02/04		- DSC			03.2023-2344.3 010647	ATE Ø1 23,8 Ø2 22,2
318 Ci	85 - 87	12/99→08/01		- DSC			03.2022-2624.3 010588	Ø1 22,2 Ø2 20,6
				02/01→; + DSC			03.2023-2256.3 010870	ATE Ø1 23,8 Ø2 22,2
318 Ci	100	12/00→05/06		09/01→; + DSC			03.2023-2256.3 010870	ATE Ø1 23,8 Ø2 22,2
				09/01→; - DSC			03.2023-2344.3 010647	ATE Ø1 23,8 Ø2 22,2
318 Ci	110	03/04→05/06					03.2023-2256.3 010870	ATE Ø1 23,8 Ø2 22,2
320 Cd	110	11/03→07/06						
330 Cd	150	03/03→07/06						
320 Ci	110	02/99→08/01		08/99→ 09/00; - DSC			03.2022-2624.3 010588	Ø1 22,2 Ø2 20,6
320 Ci	120 - 125	01/00→05/06		09/00→ 08/01; - DSC			03.2022-2624.3 010588	Ø1 22,2 Ø2 20,6
				09/00→; + DSC			03.2023-2256.3 010870	ATE Ø1 23,8 Ø2 22,2
				09/01→; - DSC			03.2023-2344.3 010647	ATE Ø1 23,8 Ø2 22,2
323 Ci	120 - 125	04/99→09/00		- DSC			03.2022-2624.3 010588	Ø1 22,2 Ø2 20,6
328 Ci	142	12/98→05/00						
325 Ci	141	09/00→05/06		→ 08/01; - DSC			03.2022-2624.3 010588	Ø1 22,2 Ø2 20,6
				+ DSC			03.2023-2256.3 010870	ATE Ø1 23,8 Ø2 22,2
				09/01→; - DSC			03.2023-2344.3 010647	ATE Ø1 23,8 Ø2 22,2
330 Ci	170	06/00→05/06		→ 08/00; + DSC			03.2023-2204.3 010644	ATE Ø1 23,8 Ø2 22,2
330 xi	170	06/00→07/06		09/00→; + DSC			03.2023-2256.3 010870	ATE Ø1 23,8 Ø2 22,2
				→ 08/01; - DSC			03.2023-2304.3 010646	ATE Ø1 23,8 Ø2 22,2
				09/01→; - DSC			03.2023-2344.3 010647	ATE Ø1 23,8 Ø2 22,2











	kw			 	! #		
BMW - 3 Coupe (E92) 01/05→12/13							
Bremskraftverstärker							
316 i 320 i	90 125	09/07→06/13 03/07→06/13		09/09→; für Fahrzeuge ohne Start-Stopp-Funktion → 08/09		03.7848-4003.4 300235	ATE Ø 8" pneumatisch
318 i	105	03/10→12/13		→ 06/13; für Fahrzeuge ohne Start-Stopp-Funktion		03.7848-4003.4 300235	ATE Ø 8" pneumatisch
320 d	120	03/07→06/13		09/09→; für Fahrzeuge ohne Start-Stopp-Funktion → 08/09		03.7845-0103.4 300268 03.7848-5003.4 300236	ATE Ø 8" pneumatisch ATE Ø 8" pneumatisch
320 d	130 - 145	09/06→02/10		09/09→; für Fahrzeuge ohne Start-Stopp-Funktion 03/07→ 08/09		03.7845-0103.4 300268 03.7848-5003.4 300236	ATE Ø 8" pneumatisch ATE Ø 8" pneumatisch
320 d 320 d xDrive	135 - 147 120 - 147	03/10→06/13 09/08→06/13		für Fahrzeuge ohne Start-Stopp-Funktion		03.7845-0103.4 300268	ATE Ø 8" pneumatisch
320 i	115	06/07→12/13		09/09→ 06/13; für Fahrzeuge ohne Start-Stopp-Funktion → 08/09		03.7848-4003.4 300235 03.7848-4003.4 300235	ATE Ø 8" pneumatisch ATE Ø 8" pneumatisch
320 i	120	01/07→06/13		09/09→; für Fahrzeuge ohne Start-Stopp-Funktion 03/07→ 08/09		03.7848-4003.4 300235 03.7848-4003.4 300235	ATE Ø 8" pneumatisch ATE Ø 8" pneumatisch
323 i	140	04/06→02/12		09/07→ 09/06→ 08/07		03.7845-0103.4 300268 03.7848-5003.4 300236	ATE Ø 8" pneumatisch ATE Ø 8" pneumatisch
325 d	145 - 155	02/07→02/10		03/07→		03.7848-5003.4 300236	ATE Ø 8" pneumatisch
325 d 325 i 325 i xDrive 325 xi	150 150 - 160 150 - 155 155 - 160	09/09→06/13 09/07→10/13 09/08→06/13 09/06→02/10				03.7848-5003.4 300236	ATE Ø 8" pneumatisch
328 i 328 i xDrive 328 xi 330 d xDrive 330 i 330 i xDrive	172 172 172 180 190 200	06/06→06/13 09/08→06/13 09/06→08/08 02/10→06/13 03/10→06/13 03/10→06/13					
325 i	160	06/06→02/10		09/06→		03.7848-5003.4 300236	ATE Ø 8" pneumatisch
325 i xDrive	160	09/08→12/13		→ 06/13		03.7848-5003.4 300236	ATE Ø 8" pneumatisch
330 d 330 xd 335 d 335 i	170 170 210 225 - 240	03/06→08/08 03/06→08/08 03/06→03/13 06/06→06/13		09/06→		03.7845-0103.4 300268	ATE Ø 8" pneumatisch
330 d 330 i 330 xd	180 200 180	01/09→06/13 09/06→06/13 03/08→02/10		→ 08/09 09/09→		03.7845-0103.4 300268 03.7848-5003.4 300236	ATE Ø 8" pneumatisch ATE Ø 8" pneumatisch
330 xi 335 i 335 i xDrive	190 - 200 224 225 - 240	09/06→08/07 03/07→06/13 11/08→12/13				03.7845-0103.4 300268	ATE Ø 8" pneumatisch
330 xi	200	03/07→02/10		→ 08/09		03.7845-0103.4 300268 03.7848-5003.4 300236	ATE Ø 8" pneumatisch ATE Ø 8" pneumatisch
335 xi	225 - 240	03/07→02/10		09/07→		03.7845-0103.4 300268	ATE Ø 8" pneumatisch
Hauptbremszylinder							
316 i	90	09/07→06/13		für Linkslenker		03.2023-2407.3 010796	ATE Ø1 23,8 Ø2 22,2
318 i	105	03/10→12/13		für Linkslenker; → 06/13		03.2023-2407.3 010796	ATE Ø1 23,8 Ø2 22,2
320 d 325 d 325 i 330 d 330 i 335 i	120 - 147 150 150 - 160 180 190 - 200 224	03/07→06/13 09/09→06/13 09/07→10/13 01/09→06/13 09/06→06/13 03/07→06/13		für Linkslenker		03.2025-1904.3 010797	ATE Ø1 25,4 Ø2 22,2
320 d 325 d	130 - 145 145 - 155	09/06→02/10 02/07→02/10		03/07→; für Linkslenker		03.2025-1904.3 010797	ATE Ø1 25,4 Ø2 22,2
→							











	kw			 	! #		
BMW - 3 Coupe (E92) 01/05→12/13							
 Hauptbremszylinder							
320 d xDrive	120 - 147	09/08→06/13				03.2025-1904.3 010797	ATE Ø1 25,4 Ø2 22,2
325 i xDrive	150 - 155	09/08→06/13					
325 xi	155 - 160	09/06→02/10					
328 i	172	06/06→06/13					
328 i xDrive	172	09/08→06/13					
328 xi	172	09/06→08/08					
330 d xDrive	180	02/10→06/13					
330 i xDrive	200	03/10→06/13					
330 xd	180	03/08→02/10					
330 xi	190 - 200	09/06→02/10					
335 i xDrive	225 - 240	11/08→12/13					
320 i	115	06/07→12/13		09/07→ 06/13; für Linkslenker		03.2023-2407.3 010796	ATE Ø1 23,8 Ø2 22,2
				→ 08/07; für Linkslenker		03.2025-1904.3 010797	ATE Ø1 25,4 Ø2 22,2
320 i	120	01/07→06/13		09/07→; für Linkslenker		03.2023-2407.3 010796	ATE Ø1 23,8 Ø2 22,2
				03/07→ 08/07; für Linkslenker		03.2025-1904.3 010797	ATE Ø1 25,4 Ø2 22,2
320 i	125	03/07→06/13		09/07→; für Linkslenker		03.2023-2407.3 010796	ATE Ø1 23,8 Ø2 22,2
				→ 08/07; für Linkslenker		03.2025-1904.3 010797	ATE Ø1 25,4 Ø2 22,2
325 i	160	06/06→02/10		09/06→; für Linkslenker		03.2025-1904.3 010797	ATE Ø1 25,4 Ø2 22,2
330 d	170	03/06→08/08					
335 d	210	03/06→03/13					
335 i	225 - 240	06/06→06/13					
325 i xDrive	160	09/08→12/13		→ 06/13		03.2025-1904.3 010797	ATE Ø1 25,4 Ø2 22,2
330 xd	170	03/06→08/08		09/06→		03.2025-1904.3 010797	ATE Ø1 25,4 Ø2 22,2
335 xi	225 - 240	03/07→02/10		09/07→		03.2025-1904.3 010797	ATE Ø1 25,4 Ø2 22,2
Hydraulikaggregat, Bremsanlage							
316 i	90	09/07→06/13		09/08→		24.9145-0003.2 399007	
318 i	105	03/10→12/13		→ 06/13		24.9145-0003.2 399007	
320 d	120 - 145	09/06→06/13		09/08→; für Fahrzeuge ohne Aktivlenkung		24.9145-0003.2 399007	
320 i	120 - 125	01/07→06/13					
320 d	135 - 147	03/10→06/13		für Fahrzeuge ohne Aktivlenkung		24.9145-0003.2 399007	
320 i	115	06/07→12/13		09/08→ 06/13; für Fahrzeuge ohne Aktivlenkung		24.9145-0003.2 399007	
BMW - 3 Gran Turismo (F34) 07/12→							
 Hauptbremszylinder							
318 d	100 - 110	03/13→		für Linkslenker; - Performance Parts		24.4123-1736.3 011118	Ø 23,8 ohne Bremsflüssigkeitsbehälter
320 d	120 - 147	03/13→		für Linkslenker; + Performance Parts		24.4125-1713.3 011109	Ø 25,4 ohne Bremsflüssigkeitsbehälter
320 i	120 - 135	03/13→					
320 i xDrive	120 - 135	07/13→					
320 d xDrive	120 - 147	07/13→		für Linkslenker		24.4125-1713.3 011109	Ø 25,4 ohne Bremsflüssigkeitsbehälter
328 i	180	03/13→06/16					
328 i xDrive	180	07/13→06/16					
330 d	190	03/14→					
330 d xDrive	190	03/14→					
335 d xDrive	230	03/14→					
335 i	225 - 250	03/13→06/16					
335 i xDrive	225 - 250	03/13→06/16					
320 i xDrive	135	11/12→06/16		03/13→; für Linkslenker; - Performance Parts		24.4123-1736.3 011118	Ø 23,8 ohne Bremsflüssigkeitsbehälter
				03/13→; für Linkslenker; + Performance Parts		24.4125-1713.3 011109	Ø 25,4 ohne Bremsflüssigkeitsbehälter
325 d	155 - 165	07/13→02/18		für Linkslenker; - Performance Parts		24.4125-1713.3 011109	Ø 25,4 ohne Bremsflüssigkeitsbehälter
330 i	185	07/16→					
330 i xDrive	185	07/16→					
340 i	240 - 265	07/16→					
→							









	kw					! #		
BMW - 3 Gran Turismo (F34) 07/12→								
 Hauptbremszylinder								
340 i xDrive	240 - 265	07/16→			für Linkslenker; - Performance Parts		24.4125-1713.3 011109	Ø 25,4 ohne Bremsflüssigkeitsbehälter
330 d 330 d xDrive	210	03/14→ 210 03/14→			09/15→; für Linkslenker		24.4125-1713.3 011109	Ø 25,4 ohne Bremsflüssigkeitsbehälter
330 i xDrive	183	07/16→			für Linkslenker; für Fahrzeuge ohne M-Sportbremse		24.4125-1713.3 011109	Ø 25,4 ohne Bremsflüssigkeitsbehälter
BMW - 3 Touring (E46) 06/99→07/05								
 Bremskraftverstärker								
316 i 318 d 318 i	85	03/02→02/05 10/02→02/05 10/99→07/05					03.7860-0702.4 300123	ATE Ø 10" pneumatisch
320 d	100 - 110	03/00→02/05 10/99→02/05						
320 i	110 - 125	09/00→02/05 09/00→02/05						
325 i 325 xi 328 i 330 d	141 - 150	06/99→05/00 10/99→02/05						
330 i 330 xi	170	06/00→02/05 06/00→02/05						
330 xd	135	01/00→03/03		06/00→			03.7860-0702.4 300123	ATE Ø 10" pneumatisch
330 xd	150	08/02→05/05		03/03→ 02/05			03.7860-0702.4 300123	ATE Ø 10" pneumatisch
 Hauptbremszylinder								
316 i 318 d 318 i 320 d	85 - 110	03/02→02/05 10/02→02/05 09/01→07/05 09/01→02/05		+ DSC - DSC			03.2023-2256.3 010870 03.2023-2344.3 010647	ATE Ø1 23,8 Ø2 22,2
318 i	85 - 87	10/99→09/01		- DSC			03.2022-2624.3 010588	Ø1 22,2 Ø2 20,6
320 d 320 i 328 i	100 - 142	03/00→09/01 10/99→09/00 06/99→05/00						
320 i	120 - 125	09/00→02/05		→ 08/01; - DSC + DSC			03.2022-2624.3 010588 03.2023-2256.3 010870	Ø1 22,2 Ø2 20,6 ATE Ø1 23,8 Ø2 22,2
325 i	141	09/00→02/05		09/01→; - DSC			03.2023-2344.3 010647	ATE Ø1 23,8 Ø2 22,2
330 d	135	10/99→02/05		→ 08/01; - DSC			03.2022-2624.3 010588	Ø1 22,2 Ø2 20,6
330 d	150	03/03→02/05		02/01→; + DSC 09/01→; - DSC			03.2023-2256.3 010870 03.2023-2344.3 010647	ATE Ø1 23,8 Ø2 22,2 ATE Ø1 23,8 Ø2 22,2
330 d	150	03/03→02/05		→ 08/00; + DSC 09/00→; + DSC → 08/01; - DSC 09/01→; - DSC			03.2023-2204.3 010644 03.2023-2256.3 010870 03.2023-2304.3 010646 03.2023-2344.3 010647	ATE Ø1 23,8 Ø2 22,2 ATE Ø1 23,8 Ø2 22,2 ATE Ø1 23,8 Ø2 22,2 ATE Ø1 23,8 Ø2 22,2
330 d	150	03/03→02/05		+ DSC			03.2023-2256.3 010870	ATE Ø1 23,8 Ø2 22,2
330 i	170	06/00→02/05		→ 08/01; + DSC 09/01→; + DSC → 08/01; - DSC 09/01→; - DSC			03.2023-2204.3 010644 03.2023-2256.3 010870 03.2023-2304.3 010646 03.2023-2344.3 010647	ATE Ø1 23,8 Ø2 22,2 ATE Ø1 23,8 Ø2 22,2 ATE Ø1 23,8 Ø2 22,2 ATE Ø1 23,8 Ø2 22,2
BMW - 3 Touring (E91) 12/04→12/12								
 Bremskraftverstärker								
316 d	85	09/09→06/12		→ 05/12; für Fahrzeuge ohne Start-Stopp-Funktion			03.7848-4003.4 300235	ATE Ø 8" pneumatisch
316 i	90	09/08→06/12		für Fahrzeuge ohne Start-Stopp-Funktion			03.7848-4003.4 300235	ATE Ø 8" pneumatisch
318 d 320 d	90 - 120	09/05→08/07 12/04→06/12					03.7848-5003.4 300236	ATE Ø 8" pneumatisch
325 xi	155 - 160	08/05→08/08						
330 d 330 i 330 xi	155 - 190	06/05→05/12 08/05→08/07 09/05→08/07						
318 d	100	07/07→06/12		09/07→ 05/12			03.7845-0103.4 300268	ATE Ø 8" pneumatisch
318 d 320 d xDrive 330 i 335 d	105 - 210	09/07→06/12 07/09→06/12 03/07→06/12 09/06→06/12		→ 05/12			03.7845-0103.4 300268	ATE Ø 8" pneumatisch
→								











	kw			 	! #		
BMW - 3 Touring (E91) 12/04→12/12							
 Bremskraftverstärker							
318 i	95	01/06→08/07		03/07→; Motorcode: N46N		03.7845-0103.4 300268	ATE Ø 8" pneumatisch
				Motorcode: N46		03.7848-5003.4 300236	ATE Ø 8" pneumatisch
318 i	100 - 105	05/07→05/12		09/07→		03.7845-0103.4 300268	ATE Ø 8" pneumatisch
320 d	130 - 145	02/07→12/10					
320 i	120 - 125	02/07→12/12					
318 i	100	09/07→03/12				03.7845-0103.4 300268	ATE Ø 8" pneumatisch
320 d	135 - 147	03/10→05/12					
320 d xDrive	130 - 147	02/08→06/12					
323 i	140	09/06→07/08					
330 d xDrive	180	01/09→06/12					
335 i	225 - 240	09/06→06/12					
335 i xDrive	225 - 240	09/08→06/12					
335 xi	225 - 240	03/07→08/08					
320 i	110 - 115	09/05→06/12		→ 08/07; Motorcode: N46N		03.7845-0103.4 300268	ATE Ø 8" pneumatisch
				→ 08/07; Motorcode: N46		03.7848-5003.4 300236	ATE Ø 8" pneumatisch
323 i	130	04/06→06/07		09/06→		03.7845-0103.4 300268	ATE Ø 8" pneumatisch
325 d	145 - 150	09/06→06/12		→ 05/12		03.7848-5003.4 300236	ATE Ø 8" pneumatisch
325 i	160	09/07→06/12					
325 i xDrive	155 - 160	09/08→06/12					
330 i xDrive	200	09/07→06/12					
330 xd	170	09/05→06/12					
330 xi	200	09/07→06/12					
325 i	155 - 160	12/04→12/10		06/05→		03.7848-5003.4 300236	ATE Ø 8" pneumatisch
330 d	170	12/04→08/08					
325 i	155	09/07→06/12		01/12→ 05/12		03.7848-5003.4 300236	ATE Ø 8" pneumatisch
330 d	180	02/08→05/12		09/08→		03.7845-0103.4 300268	ATE Ø 8" pneumatisch
 Hauptbremszylinder							
316 d	85	09/09→06/12		für Linkslenker; → 05/12		03.2023-2407.3 010796	ATE Ø1 23,8 Ø2 22,2
316 i	90	09/08→06/12				03.2023-2407.3 010796	ATE Ø1 23,8 Ø2 22,2
318 d	90	09/05→08/07		für Linkslenker		03.2025-1904.3 010797	ATE Ø1 25,4 Ø2 22,2
318 i	95	01/06→08/07					
320 d	110 - 147	12/04→06/12					
330 d xDrive	180	01/09→06/12					
330 i	190	08/05→08/07					
335 i	225 - 240	09/06→06/12					
318 d	100	07/07→06/12		09/07→ 05/12		03.2025-1904.3 010797	ATE Ø1 25,4 Ø2 22,2
318 d	105	09/07→06/12		→ 05/12		03.2025-1904.3 010797	ATE Ø1 25,4 Ø2 22,2
320 d xDrive	120	07/09→06/12					
325 d	145 - 150	09/06→06/12					
325 i xDrive	155 - 160	09/08→06/12					
330 i xDrive	200	09/07→06/12					
330 xd	170	09/05→06/12					
330 xi	200	09/07→06/12					
318 i	100 - 105	05/07→05/12		09/07→		03.2025-1904.3 010797	ATE Ø1 25,4 Ø2 22,2
318 i	100	09/07→03/12				03.2025-1904.3 010797	ATE Ø1 25,4 Ø2 22,2
320 d xDrive	130 - 147	02/08→06/12					
325 xi	155 - 160	08/05→08/08					
330 d	155	06/05→05/12					
330 xi	190	09/05→08/07					
335 i xDrive	225 - 240	09/08→06/12					
335 xi	225 - 240	03/07→08/08					
320 d	130 - 145	02/07→12/10		09/07→; für Linkslenker		03.2025-1904.3 010797	ATE Ø1 25,4 Ø2 22,2
320 i	120 - 125	02/07→12/12					
320 i	110 - 115	09/05→06/12		→ 08/07; für Linkslenker		03.2025-1904.3 010797	ATE Ø1 25,4 Ø2 22,2
→							













	kw			 	! #		
BMW - 3 Touring (E91) 12/04→12/12							
 Hauptbremszylinder							
325 i	155 - 160	12/04→12/10		06/05→; für Linkslenker		03.2025-1904.3 010797	ATE Ø1 25,4 Ø2 22,2
325 i	155	09/07→06/12		01/12→; für Linkslenker; → 05/12		03.2025-1904.3 010797	ATE Ø1 25,4 Ø2 22,2
325 i 330 i 335 d	160 200 210	09/07→06/12 03/07→06/12 09/06→06/12		→ 05/12; für Linkslenker		03.2025-1904.3 010797	ATE Ø1 25,4 Ø2 22,2
330 d	170	12/04→08/08		06/05→		03.2025-1904.3 010797	ATE Ø1 25,4 Ø2 22,2
330 d	180	02/08→05/12		09/08→; für Linkslenker		03.2025-1904.3 010797	ATE Ø1 25,4 Ø2 22,2
Hydraulikaggregat, Bremsanlage							
316 d	85	09/09→06/12		→ 05/12		24.9145-0003.2 399007	
316 i	90	09/08→06/12				24.9145-0003.2 399007	
318 d	100 - 105	07/07→06/12		09/08→ 05/12		24.9145-0003.2 399007	
318 i	100 - 105	05/07→05/12		09/08→		24.9145-0003.2 399007	
320 d 320 i	130 - 145 120 - 125	02/07→12/10 02/07→12/12		09/08→; für Fahrzeuge ohne Aktivlenkung		24.9145-0003.2 399007	
320 d	135 - 147	03/10→05/12		für Fahrzeuge ohne Aktivlenkung		24.9145-0003.2 399007	
BMW - 3 Touring (F31) 07/12→06/19							
 Hauptbremszylinder							
316 d 318 d	85 100 - 105	11/12→06/19 11/12→06/19		für Linkslenker; für Fahrzeuge ohne Start-Stopp-Funktion		24.4123-1736.3 011118	Ø 23,8 ohne Bremsflüssigkeitsbehälter
320 d 320 i 320 i xDrive	120 120 - 135 120 - 135	07/12→06/19 11/12→06/19 03/13→06/19		für Linkslenker; für Fahrzeuge mit Start-Stopp-Funktion		24.4125-1713.3 011109	Ø 25,4 ohne Bremsflüssigkeitsbehälter
316 i	100	03/13→06/15		für Linkslenker		24.4123-1736.3 011118	Ø 23,8 ohne Bremsflüssigkeitsbehälter
318 d 318 d xDrive	110 105 - 110	07/15→06/19 07/13→02/18		- Performance Parts; für Linkslenker		24.4123-1736.3 011118	Ø 23,8 ohne Bremsflüssigkeitsbehälter
318 i	100	07/15→06/19		für Linkslenker; + Performance Parts		24.4125-1713.3 011109	Ø 25,4 ohne Bremsflüssigkeitsbehälter
320 d 320 d xDrive	135 - 147 120 - 147	07/12→06/19 03/13→06/19		für Linkslenker		24.4125-1713.3 011109	Ø 25,4 ohne Bremsflüssigkeitsbehälter
325 d 328 i 328 i xDrive 330 d 330 d xDrive 335 d xDrive 335 i 335 i xDrive	165 180 180 190 190 230 225 - 250 225 - 250	03/16→02/18 07/12→06/15 03/13→06/16 07/12→06/19 03/13→06/19 11/13→06/19 03/13→06/15 03/13→06/15					
325 d	155 - 160	03/13→02/16		04/13→; für Linkslenker		24.4125-1713.3 011109	Ø 25,4 ohne Bremsflüssigkeitsbehälter
330 d 330 d M Performance Power Kit xDrive	210 210	07/12→06/19 03/13→06/19		09/15→; für Linkslenker; - Performance Parts		24.4125-1713.3 011109	Ø 25,4 ohne Bremsflüssigkeitsbehälter
330 i 330 i xDrive 340 i	185 185 240 - 265	07/15→06/19 07/15→06/19 07/15→06/19		für Linkslenker; - Performance Parts		24.4125-1713.3 011109	Ø 25,4 ohne Bremsflüssigkeitsbehälter
BMW - 3 Touring Van (F31) 07/12→06/19							
 Hauptbremszylinder							
330 d 330 d xDrive	190 190	07/12→06/19 03/13→06/19		für Linkslenker		24.4125-1713.3 011109	Ø 25,4 ohne Bremsflüssigkeitsbehälter
330 i 340 i	185 240	07/15→06/19 07/15→06/19		für Linkslenker; - Performance Parts		24.4125-1713.3 011109	Ø 25,4 ohne Bremsflüssigkeitsbehälter
BMW - 4 Cabriolet (F33, F83) 10/13→08/20							
 Hauptbremszylinder							
420 d →	120 - 147	10/13→07/20		für Linkslenker		24.4125-1713.3 011109	Ø 25,4 ohne Bremsflüssigkeitsbehälter













	kW			 	! #		
BMW - 4 Cabriolet (F33, F83) 10/13→08/20							
 Hauptbremszylinder							
425 d	155 - 160	07/14→02/16		für Linkslenker		24.4125-1713.3 011109	Ø 25,4 ohne Bremsflüssigkeitsbehälter
428 i	180	11/13→02/17					
428 i xDrive	180	03/14→02/16					
430 d	190 - 210	07/14→07/20					
435 d xDrive	230	07/14→07/20					
435 i	225 - 250	11/13→02/16					
435 i xDrive	225 - 250	07/14→02/16					
420 d	140 - 151	07/15→07/20		für Linkslenker; - Performance Parts		24.4125-1713.3 011109	Ø 25,4 ohne Bremsflüssigkeitsbehälter
425 d	165	03/16→02/18					
430 i	185	03/16→07/20					
430 i xDrive	185	03/16→07/20					
440 i	240 - 265	03/16→07/20					
440 i xDrive	240 - 265	03/16→07/20					
420 i	120 - 135	07/14→07/20		für Linkslenker; - Performance Parts		24.4123-1736.3 011118	Ø 23,8 ohne Bremsflüssigkeitsbehälter
425 i	135	06/17→07/20		für Linkslenker; + Performance Parts		24.4125-1713.3 011109	Ø 25,4 ohne Bremsflüssigkeitsbehälter
BMW - 4 Coupe (F32, F82) 07/13→06/20							
 Hauptbremszylinder							
418 d	100 - 110	03/15→10/17		für Linkslenker; - Performance Parts		24.4123-1736.3 011118	Ø 23,8 ohne Bremsflüssigkeitsbehälter
418 i	100	03/16→06/20					
420 d	120 - 147	07/13→06/20		für Linkslenker; + Performance Parts		24.4125-1713.3 011109	Ø 25,4 ohne Bremsflüssigkeitsbehälter
420 d xDrive	120 - 147	11/13→06/20					
420 i	120 - 135	11/13→02/17					
420 i xDrive	120 - 135	11/13→02/16					
428 i	180	07/13→02/17					
428 i xDrive	180	07/13→02/16					
435 i	225 - 250	07/13→02/16					
435 i xDrive	225 - 250	07/13→02/16					
420 i	120 - 135	03/16→06/20		für Linkslenker; Motorcode: B48; - Performance Parts		24.4123-1736.3 011118	Ø 23,8 ohne Bremsflüssigkeitsbehälter
420 i xDrive	120 - 135	03/16→06/20		für Linkslenker; Motorcode: B48; + Performance Parts		24.4125-1713.3 011109	Ø 25,4 ohne Bremsflüssigkeitsbehälter
425 i	135	06/17→06/20					
425 d	155 - 160	03/14→02/16		für Linkslenker		24.4125-1713.3 011109	Ø 25,4 ohne Bremsflüssigkeitsbehälter
430 d	190 - 210	11/13→06/20					
430 d xDrive	190 - 210	03/14→06/20					
435 d xDrive	230	11/13→06/20					
425 d	165	03/16→10/17		für Linkslenker; - Performance Parts		24.4125-1713.3 011109	Ø 25,4 ohne Bremsflüssigkeitsbehälter
430 i	183 - 185	03/16→06/20					
430 i xDrive	183 - 185	03/16→06/20					
440 i	240 - 265	03/16→06/20					
440 i xDrive	240 - 265	03/16→06/20					
BMW - 4 Gran Coupe (F36) 03/14→05/21							
 Hauptbremszylinder							
418 d	100 - 105	03/14→12/20		- Performance Parts		24.4123-1736.3 011118	Ø 23,8 ohne Bremsflüssigkeitsbehälter
418 i	100	07/15→12/20					
420 d	120 - 147	03/14→12/20		+ Performance Parts		24.4125-1713.3 011109	Ø 25,4 ohne Bremsflüssigkeitsbehälter
418 d	110	07/15→12/20		- Performance Parts; für Linkslenker		24.4123-1736.3 011118	Ø 23,8 ohne Bremsflüssigkeitsbehälter
420 i	120 - 135	03/16→05/21					
420 i xDrive	120 - 135	03/16→05/21		für Linkslenker; + Performance Parts		24.4125-1713.3 011109	Ø 25,4 ohne Bremsflüssigkeitsbehälter
425 i	135	06/17→12/20					
→							











	kw			 	! #		
BMW - 4 Gran Coupe (F36) 03/14→05/21							
 Hauptbremszylinder							
420 d 420 d xDrive	140 120 - 147	03/15→12/20 03/14→12/20		für Linkslenker		24.4125-1713.3 011109	Ø 25,4 ohne Bremsflüssigkeitsbehälter
420 i 420 i xDrive	120 - 135 120 - 135	03/14→02/17 07/14→02/16					
428 i 430 d	180 190 - 210	03/14→06/16 07/14→12/20					
430 d xDrive 435 d xDrive 435 i	190 - 210 230 225 - 250	07/14→12/20 07/14→12/20 03/14→02/16					
425 d 430 i 430 i xDrive	155 - 165 185 183 - 185	03/16→02/18 03/16→05/21 03/16→05/21		für Linkslenker; - Performance Parts		24.4125-1713.3 011109	Ø 25,4 ohne Bremsflüssigkeitsbehälter
440 i 440 i xDrive	240 - 265 240 - 265	03/16→05/21 03/16→05/21					
428 i xDrive 435 i xDrive	180 225 - 250	03/14→02/16 07/14→02/16				24.4125-1713.3 011109	Ø 25,4 ohne Bremsflüssigkeitsbehälter
BMW - 5 (E39) 09/95→07/03							
 Hauptbremszylinder							
520 d	100	02/00→06/03		04/00→		24.2025-1705.3 010624	TRW Ø1 25,4 Ø2 20,6
520 i	100 - 125	01/96→06/03		+ DSC		24.2025-1704.3 010619	Ø 25,4
530 d	142	09/98→06/03		- DSC		24.2025-1705.3 010624	TRW Ø1 25,4 Ø2 20,6
520 i	110	01/96→06/03		03/96→; + DSC		24.2025-1704.3 010619	Ø 25,4
				09/97→; - DSC		24.2025-1705.3 010624	TRW Ø1 25,4 Ø2 20,6
				03/96→ 08/97; - DSC		24.2120-1721.3 010553	Ø 20,6
523 i 528 i	125 142	09/95→08/00 09/95→08/00		12/95→; + DSC		24.2025-1704.3 010619	Ø 25,4
				09/97→; - DSC		24.2025-1705.3 010624	TRW Ø1 25,4 Ø2 20,6
				12/95→ 08/97; - DSC		24.2120-1721.3 010553	Ø 20,6
525 d	120	02/00→06/03		04/00→; + DSC		24.2025-1704.3 010619	Ø 25,4
				04/00→; - DSC		24.2025-1705.3 010624	TRW Ø1 25,4 Ø2 20,6
525 i 530 i	141 170	09/00→06/03 09/00→06/03		10/00→; + DSC		24.2025-1704.3 010619	Ø 25,4
				10/00→; - DSC		24.2025-1705.3 010624	TRW Ø1 25,4 Ø2 20,6
525 td	85	01/97→06/03		09/97→ 09/00		24.2025-1705.3 010624	TRW Ø1 25,4 Ø2 20,6
				→ 08/97		24.2120-1721.3 010553	Ø 20,6
525 tds	105	01/96→06/03		09/97→ 09/00		24.2025-1705.3 010624	TRW Ø1 25,4 Ø2 20,6
				02/96→ 08/97		24.2120-1721.3 010553	Ø 20,6
530 d	135	08/98→09/00		09/98→; + DSC		24.2025-1704.3 010619	Ø 25,4
				09/98→; - DSC		24.2025-1705.3 010624	TRW Ø1 25,4 Ø2 20,6
535 i M5	180 294	09/98→06/03 10/98→06/03				24.2025-1704.3 010619	Ø 25,4
540 i	210	03/96→06/03		09/97→		24.2025-1704.3 010619	Ø 25,4
				05/96→ 08/97		24.2120-1721.3 010553	Ø 20,6
BMW - 5 (E60) 12/01→03/10							
 Hauptbremszylinder							
520 d	110 - 130	09/05→12/09				24.2026-1702.3 010850	TRW Ø 27 Ø2 22,2
523 i	140	03/07→12/09					
525 d xDrive	145	09/08→12/09					
525 xd	145	09/07→08/08					
525 xi	160	04/05→12/09					
528 i	172	03/07→12/09					
530 d	170	09/05→03/07					
530 d xDrive	173	09/07→12/09					
530 i	200	03/07→12/09					
530 i xDrive	200	09/08→12/09					
530 xd	173	03/07→08/07					
530 xi	200	03/07→10/09					
535 i	225	04/06→12/09					
540 i	220 - 225	09/05→12/09					
→							













	kW				! #		
BMW - 5 (E60) 12/01→03/10							
 Hauptbremszylinder							
545 i	245	07/03→08/05				24.2026-1702.3 010850	TRW Ø 27 Ø2 22,2
550 i	270	09/05→12/09					
M5	373	09/04→12/09					
520 i	125	07/03→03/10		→ 03/05		24.2025-1710.3 010833	TRW Ø 25,4
523 i	130	10/04→02/07		07/05→		24.2026-1702.3 010850	TRW Ø 27 Ø2 22,2
525 i	137 - 160	07/03→12/09					
530 i	190	03/05→03/07					
530 xd	170	02/05→02/07					
530 xi	190	09/04→02/07					
525 d	120 - 130	06/04→03/10		→ 03/07		24.2026-1702.3 010850	TRW Ø 27 Ø2 22,2
535 d	200	09/04→03/10					
525 d	145	01/07→03/10		03/07→ 02/10		24.2026-1702.3 010850	TRW Ø 27 Ø2 22,2
535 d	210	01/07→03/10					
525 i	141	09/03→02/05				24.2025-1710.3 010833	TRW Ø 25,4
525 i	155 - 160	07/05→03/10		→ 02/10		24.2026-1702.3 010850	TRW Ø 27 Ø2 22,2
525 i xDrive	160	09/08→03/10					
530 d	155 - 160	09/02→12/09		07/03→ 08/05		24.2026-1702.3 010850	TRW Ø 27 Ø2 22,2
530 d	173	02/07→12/09		03/07→		24.2026-1702.3 010850	TRW Ø 27 Ø2 22,2
530 xi	200	02/07→08/08					
530 i	170	12/01→02/05		07/03→		24.2025-1710.3 010833	TRW Ø 25,4
530 i	187	03/05→03/10		07/05→ 03/07		24.2026-1702.3 010850	TRW Ø 27 Ø2 22,2
BMW - 5 (F10) 01/09→10/16							
 Hauptbremszylinder							
518 d	100 - 110	07/13→10/16				24.2026-1706.3 011040	TRW Ø 27 Ø2 22,2
520 d	100 - 151	06/10→10/16					
520 d xDrive	100 - 151	01/13→10/16					
520 i	120 - 135	09/11→10/16					
525 d	150 - 160	03/10→10/16					
525 d xDrive	155 - 160	09/11→10/16					
528 i	180 - 190	03/10→10/16					
528 i xDrive	180	09/11→10/16					
530 d	190	09/11→10/16					
530 d xDrive	190	03/11→10/16					
535 d	220 - 230	09/10→10/16					
535 d xDrive	230	09/11→10/16					
535 i	240	07/13→10/16					
535 i xDrive	225 - 240	03/11→10/16					
550 i	300 - 330	03/10→10/16					
550 i xDrive	330	07/13→10/16					
M 550 d xDrive	280	03/12→10/16					
518 d	120	10/13→10/16		07/14→		24.2026-1706.3 011040	TRW Ø 27 Ø2 22,2
520 d	155	10/13→10/16					
520 d xDrive	155	10/13→10/16					
520 d xDrive	147	01/13→06/14		02/13→		24.2026-1706.3 011040	TRW Ø 27 Ø2 22,2
523 i	150 - 155	06/09→08/11		03/10→		24.2026-1706.3 011040	TRW Ø 27 Ø2 22,2
530 d	180	01/10→08/11					
535 i	225	01/10→10/16					
530 d	210	09/10→10/16		10/15→		24.2026-1706.3 011040	TRW Ø 27 Ø2 22,2
530 d xDrive	210	03/11→10/16					
530 i	190 - 200	03/10→06/13		09/11→		24.2026-1706.3 011040	TRW Ø 27 Ø2 22,2
550 i xDrive	300	08/10→06/13		09/10→		24.2026-1706.3 011040	TRW Ø 27 Ø2 22,2
BMW - 5 Gran Turismo (F07) 01/09→02/17							
 Hauptbremszylinder							
520 d	100 - 120	07/12→02/17				24.2026-1702.3 010850	TRW Ø 27 Ø2 22,2
530 d	155 - 190	09/10→02/17					
530 d xDrive	190	07/12→02/17					
→							

















	kw			 	! #		
BMW - 5 Gran Turismo (F07) 01/09→02/17							
 Hauptbremszylinder							
535 d	220 - 230	03/10→02/17				24.2026-1702.3 010850	TRW Ø 27 Ø2 22,2
535 d xDrive	230	07/12→02/17					
535 i xDrive	225	09/10→02/17					
550 i	330	07/12→02/17					
550 i xDrive	330	07/12→02/17					
520 d	135	04/11→02/17		10/11→		24.2026-1702.3 010850	TRW Ø 27 Ø2 22,2
528 i	180	07/13→02/17		08/13→		24.2026-1702.3 010850	TRW Ø 27 Ø2 22,2
530 d	180	08/09→06/12		10/09→		24.2026-1702.3 010850	TRW Ø 27 Ø2 22,2
535 i	225	01/09→02/17					
550 i	300	08/09→06/12					
530 d xDrive	180	06/10→06/12		09/10→		24.2026-1702.3 010850	TRW Ø 27 Ø2 22,2
535 d xDrive	220	03/10→06/12					
550 i xDrive	300	06/10→06/12					
BMW - 5 Touring (E39) 09/96→06/04							
 Hauptbremszylinder							
520 d	100	02/00→09/03		04/00→ 07/03		24.2025-1705.3 010624	TRW Ø1 25,4 Ø2 20,6
520 i	100	03/97→08/01		+ DSC		24.2025-1704.3 010619	Ø 25,4
523 i	120	09/98→08/00		- DSC		24.2025-1705.3 010624	TRW Ø1 25,4 Ø2 20,6
520 i	110	03/97→08/01		05/97→; + DSC		24.2025-1704.3 010619	Ø 25,4
523 i	125	03/97→08/00		09/97→; - DSC		24.2025-1705.3 010624	TRW Ø1 25,4 Ø2 20,6
528 i	142	11/96→08/00		05/97→ 08/97; - DSC		24.2120-1721.3 010553	Ø 20,6
520 i	120 - 125	09/00→12/03		→ 07/03; + DSC		24.2025-1704.3 010619	Ø 25,4
530 d	142	09/00→05/04		→ 07/03; - DSC		24.2025-1705.3 010624	TRW Ø1 25,4 Ø2 20,6
525 d	120	02/00→05/04		04/00→ 07/03; + DSC		24.2025-1704.3 010619	Ø 25,4
				04/00→ 07/03; - DSC		24.2025-1705.3 010624	TRW Ø1 25,4 Ø2 20,6
525 i	141	09/00→05/04		10/00→ 07/03; + DSC		24.2025-1704.3 010619	Ø 25,4
530 i	170	09/00→12/03		10/00→ 07/03; - DSC		24.2025-1705.3 010624	TRW Ø1 25,4 Ø2 20,6
525 tds	105	03/97→05/04		06/98→ 09/00		24.2025-1705.3 010624	TRW Ø1 25,4 Ø2 20,6
530 d	135	08/98→09/00		09/98→; + DSC		24.2025-1704.3 010619	Ø 25,4
				09/98→; - DSC		24.2025-1705.3 010624	TRW Ø1 25,4 Ø2 20,6
540 i	210	04/97→12/03		09/97→ 07/03		24.2025-1704.3 010619	Ø 25,4
				05/97→ 08/97		24.2120-1721.3 010553	Ø 20,6
BMW - 5 Touring (E61) 03/04→12/10							
 Hauptbremszylinder							
520 d	110 - 130	09/05→05/10				24.2026-1702.3 010850	TRW Ø 27 Ø2 22,2
523 i	140	03/07→01/10					
525 d	145	03/07→05/10					
525 d xDrive	145	09/08→05/10					
525 xd	145	09/07→09/08					
530 d xDrive	173	09/07→05/10					
530 i xDrive	200	09/08→05/10					
530 xd	173	03/07→08/07					
530 xi	200	09/06→05/10					
520 d	120	04/05→05/10		07/05→		24.2026-1702.3 010850	TRW Ø 27 Ø2 22,2
530 d	170	02/05→02/07					
530 xd	170	02/05→02/07					
530 xi	190	04/05→02/07					
520 i	120 - 125	07/07→12/10		→ 05/10		24.2026-1702.3 010850	TRW Ø 27 Ø2 22,2
525 i xDrive	160	09/08→12/10					
525 xi	160	07/05→12/10					
550 i	270	07/05→12/10					
M5	373	02/07→12/10					
523 i	130	10/04→02/07		07/05→		24.2025-1710.3 010833	TRW Ø 25,4
530 i	190	09/04→02/07					
523 i	140	01/07→12/10		03/07→ 05/10		24.2026-1702.3 010850	TRW Ø 27 Ø2 22,2
530 i	200	01/07→12/10					
535 d	210	01/07→12/10					
525 d	120	03/04→03/07		12/04→		24.2026-1702.3 010850	TRW Ø 27 Ø2 22,2
525 d	130	03/04→03/07		05/04→		24.2026-1702.3 010850	TRW Ø 27 Ø2 22,2
530 d	155 - 160	03/04→05/10					
525 i	141	06/04→12/10		→ 03/05		24.2025-1710.3 010833	TRW Ø 25,4
525 i	155	03/05→05/10		→ 03/07		24.2025-1710.3 010833	TRW Ø 25,4
				03/07→		24.2026-1702.3 010850	TRW Ø 27 Ø2 22,2
525 i	160	03/05→05/10		07/05→ 03/07		24.2025-1710.3 010833	TRW Ø 25,4
→							

	kW			 	! #		
BMW - 5 Touring (E61) 03/04→12/10							
 Hauptbremszylinder							
525 i	160	03/05→05/10		03/07→		24.2026-1702.3 010850	TRW Ø 27 Ø2 22,2
525 i	155 - 160	01/07→12/10		→ 03/07		24.2025-1710.3 010833	TRW Ø 25,4
				03/07→ 05/10		24.2026-1702.3 010850	TRW Ø 27 Ø2 22,2
530 d	173	02/07→05/10		03/07→		24.2026-1702.3 010850	TRW Ø 27 Ø2 22,2
530 i	200	09/06→03/10					
535 d	200	09/04→12/10		→ 03/07		24.2026-1702.3 010850	TRW Ø 27 Ø2 22,2
545 i	245	06/04→12/10		→ 08/05		24.2026-1702.3 010850	TRW Ø 27 Ø2 22,2
BMW - 5 Touring (F11) 11/09→02/17							
 Hauptbremszylinder							
518 d	100 - 120	07/13→02/17				24.2026-1706.3 011040	TRW Ø 27 Ø2 22,2
520 d	140 - 155	07/14→02/17					
520 d xDrive	100 - 155	07/13→02/17					
520 i	120	09/11→02/17					
525 d	150 - 160	09/10→02/17					
525 d xDrive	155 - 160	07/13→02/17					
528 i	180	09/11→02/17					
528 i xDrive	180	09/11→02/17					
530 d	190	09/11→02/17					
530 d xDrive	190	03/11→02/17					
535 d	220 - 230	09/10→02/17					
535 d xDrive	230	09/11→02/17					
535 i xDrive	225	09/11→02/17					
550 i	330	07/13→02/17					
M 550 d xDrive	280	03/12→02/17					
520 d	100 - 147	06/10→02/17		09/10→		24.2026-1706.3 011040	TRW Ø 27 Ø2 22,2
523 i	150	11/09→08/11					
528 i	190	11/09→08/11					
530 d	180	06/10→08/11					
535 i	225	06/10→02/17					
520 i	135	10/10→02/17		09/11→		24.2026-1706.3 011040	TRW Ø 27 Ø2 22,2
530 i	190 - 200	03/10→06/13					
550 i	300	09/10→06/13					
530 d	210	09/11→02/17		10/15→		24.2026-1706.3 011040	TRW Ø 27 Ø2 22,2
530 d xDrive	210	03/11→02/17					
535 i	240	07/13→02/17					
535 i xDrive	240	07/13→02/17					
BMW - 6 (E63) 09/03→12/10							
 Hauptbremszylinder							
630 i	190 - 200	09/04→08/10				24.2026-1702.3 010850	TRW Ø 27 Ø2 22,2
645 Ci	245	09/03→08/05					
650 i	270	09/05→08/10					
M	373	09/05→07/10					
635 d	210	07/07→07/10		09/07→		24.2026-1702.3 010850	TRW Ø 27 Ø2 22,2
BMW - 6 Cabriolet (E64) 03/04→12/10							
 Hauptbremszylinder							
630 i	190 - 200	09/04→08/10				24.2026-1702.3 010850	TRW Ø 27 Ø2 22,2
645 Ci	245	04/04→08/05					
650 i	270	09/05→08/10					
M6	373	09/06→08/10					
635 d	210	07/07→07/10		09/07→		24.2026-1702.3 010850	TRW Ø 27 Ø2 22,2
BMW - 6 Cabriolet (F12) 12/10→06/18							
 Hauptbremszylinder							
640 d	230	09/11→06/18				24.2026-1706.3 011040	TRW Ø 27 Ø2 22,2
640 d xDrive	230	03/12→06/18					
640 i	235	09/11→06/18					
640 i xDrive	235	03/13→06/18					
650 i	298 - 330	12/10→06/18					
650 i xDrive	300	09/11→06/12					
650 i xDrive	330	07/12→06/18		09/12→		24.2026-1706.3 011040	TRW Ø 27 Ø2 22,2

















	kW					! #		
BMW - 6 Coupe (F13) 07/11→10/17								
 Hauptbremszylinder								
640 d	230	09/11→10/17					24.2026-1706.3 011040	TRW Ø 27 Ø2 22,2
640 d xDrive	230	03/12→10/17						
640 i	235	07/11→10/17						
640 i xDrive	235	03/13→10/17						
650 i	298 - 300	07/11→12/12						
650 i xDrive	300	09/11→02/15						
650 i	330	07/12→10/17		09/12→			24.2026-1706.3 011040	TRW Ø 27 Ø2 22,2
650 i xDrive	330	07/12→10/17						
BMW - 6 Gran Coupe (F06) 03/12→10/18								
 Hauptbremszylinder								
640 d	230	03/12→10/18					24.2026-1706.3 011040	TRW Ø 27 Ø2 22,2
640 d xDrive	230	03/13→10/18						
640 i	235	03/12→10/18						
640 i xDrive	235	03/13→10/18						
650 i	330	07/12→10/18						
650 i xDrive	330	07/12→10/18						
BMW - 7 (E38) 03/94→11/01								
 Hauptbremszylinder								
725 tds	105	04/96→11/01		09/98→			24.2025-1704.3 010619	Ø 25,4
				09/97→ 08/98			24.2025-1705.3 010624	TRW Ø1 25,4 Ø2 20,6
				05/96→ 08/97			24.2120-1721.3 010553	Ø 20,6
iL	142	08/95→11/01		09/98→			24.2025-1704.3 010619	Ø 25,4
728 i	142	08/95→11/01		09/97→ 08/98			24.2025-1705.3 010624	TRW Ø1 25,4 Ø2 20,6
				→ 08/97			24.2120-1721.3 010553	Ø 20,6
				01/96→ 08/97			24.2120-1721.3 010553	Ø 20,6
730 d	135	08/98→04/00		09/98→; + DSC			24.2025-1704.3 010619	Ø 25,4
				09/98→; - DSC			24.2025-1705.3 010624	TRW Ø1 25,4 Ø2 20,6
730 d	142	04/00→11/01		+ DSC			24.2025-1704.3 010619	Ø 25,4
740 d	180	05/99→11/01		- DSC			24.2025-1705.3 010624	TRW Ø1 25,4 Ø2 20,6
730 i	155	10/94→11/01		09/98→			24.2025-1704.3 010619	Ø 25,4
iL	155 - 240	10/94→11/01		09/97→ 08/98			24.2025-1705.3 010624	TRW Ø1 25,4 Ø2 20,6
740 i	210	02/96→07/01		→ 08/97			24.2120-1721.3 010553	Ø 20,6
750 i	240	11/94→07/01						
iL	175	09/98→07/01					24.2025-1704.3 010619	Ø 25,4
735 i	175	09/98→07/01						
BMW - 7 (E65, E66, E67) 07/01→12/09								
 Hauptbremszylinder								
730 d	150 - 155	09/02→08/08					24.2026-1701.3 010746	Ø 27 Ø2 20,6
730 Ld	170	07/05→08/08						
735 i	200 - 225	11/01→12/09						
Li	200 - 270	07/01→08/08						
740 d	190	10/02→02/05						
740 i	225	03/05→08/08						
745 d	220 - 242	03/05→07/08						
745 i	245	07/01→03/05						
750 i	270	03/05→08/08						
730 d	160	06/02→02/05		09/02→			24.2026-1701.3 010746	Ø 27 Ø2 20,6
730 i	170	03/03→07/08					24.2026-1701.3 010746	Ø 27 Ø2 20,6
Li	170	03/03→07/08					24.2026-1705.3 010992	TRW Ø 27 Ø2 20,6
730 i	184 - 190	03/05→08/08		07/05→			24.2026-1701.3 010746	Ø 27 Ø2 20,6
Li	184 - 190	03/05→08/08						
760 i	320 - 327	01/03→08/08		03/03→			24.2026-1701.3 010746	Ø 27 Ø2 20,6
Li	327	01/03→08/08						
BMW - 7 (F01, F02, F03, F04) 02/08→12/15								
 Hauptbremszylinder								
730 d	155	02/08→05/15		09/08→			24.2026-1702.3 010850	TRW Ø 27 Ø2 22,2
730 d	180 - 190	09/08→05/15					24.2026-1702.3 010850	TRW Ø 27 Ø2 22,2
730 i	190	09/09→06/15						
→								















	kW					! #		
BMW - 7 (F01, F02, F03, F04) 02/08→12/15								
 Hauptbremszylinder								
Li	190 - 400	09/08→12/15					24.2026-1702.3 010850	TRW Ø 27 Ø2 22,2
740 d	225 - 230	09/09→06/15						
740 d xDrive	225 - 230	09/10→06/15						
740 i	224 - 240	09/08→12/15						
Li xDrive	235 - 330	09/09→12/15						
750 d xDrive	280	07/12→12/15						
750 i	300 - 331	09/08→06/15						
760 i	400	09/09→12/15						
730 d xDrive	155 - 190	11/11→05/15		06/12→			24.2026-1702.3 010850	TRW Ø 27 Ø2 22,2
BMW - X1 (E84) 03/09→06/15								
 Bremskraftverstärker								
sDrive 16 d	85	04/12→06/15		07/12→; für Fahrzeuge ohne Start-Stopp-Funktion			03.7845-0103.4 300268	ATE Ø 8" pneumatisch
sDrive 16 i	105	03/13→06/15		Automatikgetriebe			03.7845-0103.4 300268	ATE Ø 8" pneumatisch
sDrive 18 d	100	03/09→06/15		10/09→; für Fahrzeuge ohne Start-Stopp-Funktion			03.7845-0103.4 300268	ATE Ø 8" pneumatisch
xDrive 18 d	100	03/09→06/15						
sDrive 18 d	105	12/09→06/15		für Fahrzeuge ohne Start-Stopp-Funktion			03.7845-0103.4 300268	ATE Ø 8" pneumatisch
sDrive 18 i	100 - 110	03/10→06/15						
sDrive 20 d	120 - 135	10/09→06/15						
sDrive 20 i	135	09/11→06/15						
sDrive 28 i	180	09/12→06/15						
xDrive 18 d	105	10/09→06/15						
xDrive 20 d	120 - 135	09/09→06/15						
xDrive 20 i	135	09/11→06/15						
xDrive 25 i	160	03/10→08/11						
xDrive 28 i	180 - 194	09/09→06/15						
xDrive 35 i	225	03/11→06/15						
xDrive 23 d	150	10/09→06/15		für Fahrzeuge ohne Start-Stopp-Funktion			03.7848-5003.4 300236	ATE Ø 8" pneumatisch
xDrive 25 d	160	10/09→06/15		07/12→; Automatikgetriebe			03.7845-0103.4 300268	ATE Ø 8" pneumatisch
 Hauptbremszylinder								
sDrive 16 d	85	04/12→06/15		07/12→; für Linkslenker			03.2025-1904.3 010797	ATE Ø1 25,4 Ø2 22,2
xDrive 25 d	160	10/09→06/15						
sDrive 16 i	105	03/13→06/15					03.2025-1904.3 010797	ATE Ø1 25,4 Ø2 22,2
sDrive 18 d	100	03/09→06/15		10/09→; für Linkslenker			03.2025-1904.3 010797	ATE Ø1 25,4 Ø2 22,2
xDrive 18 d	100	03/09→06/15						
sDrive 18 d	105	12/09→06/15		für Linkslenker			03.2025-1904.3 010797	ATE Ø1 25,4 Ø2 22,2
sDrive 18 i	100 - 110	03/10→06/15						
sDrive 20 d	120 - 135	10/09→06/15						
sDrive 20 i	135	09/11→06/15						
sDrive 28 i	180	09/12→06/15						
xDrive 18 d	105	10/09→06/15						
xDrive 20 d	120 - 135	09/09→06/15						
xDrive 20 i	135	09/11→06/15						
xDrive 23 d	150	10/09→06/15						
xDrive 25 i	160	03/10→08/11						
xDrive 28 i	180 - 194	09/09→06/15						
xDrive 35 i	225	03/11→06/15						
BMW - X1 (F48) 11/14→12/22								
 Hauptbremszylinder								
sDrive 16 d	85	11/14→05/22		09/15→			24.4123-1733.3 011108	Ø 23,8 ohne Bremsflüssigkeitsbehälter
sDrive 18 d	100	07/15→06/22						
xDrive 18 d	100 - 110	11/14→06/22						
xDrive 20 i	141	07/15→06/22						
xDrive 25 d	170	11/14→05/22						
xDrive 25 i	170	07/15→10/21						
sDrive 18 d	110	07/15→06/22					24.4123-1733.3 011108	Ø 23,8 ohne Bremsflüssigkeitsbehälter
sDrive 18 i	100 - 103	11/15→06/22						
→								













	kW			 	! #		
BMW - X1 (F48) 11/14→12/22							
 Hauptbremszylinder							
sDrive 20 d	120 - 140	11/15→05/22				24.4123-1733.3 011108	Ø 23,8 ohne Bremsflüssigkeitsbehälter
sDrive 20 i	131 - 141	07/15→06/22					
xDrive 20 d	140	07/15→06/22					
xDrive 20 i	131	11/20→06/22					
xDrive 25 e Plug-in-Hybrid	162	03/20→06/22					
xDrive 20 d	120	07/15→06/22		11/15→		24.4123-1733.3 011108	Ø 23,8 ohne Bremsflüssigkeitsbehälter
BMW - X1 Van (F48) 07/15→06/22							
 Hauptbremszylinder							
sDrive 18 d	110	07/15→06/22				24.4123-1733.3 011108	Ø 23,8 ohne Bremsflüssigkeitsbehälter
sDrive 18 i	103	07/17→06/22					
sDrive 20 d	140	11/15→05/22					
sDrive 20 i	141	07/17→06/22					
xDrive 20 d	140	07/15→06/22					
BMW - X2 (F39) 11/17→10/23							
 Hauptbremszylinder							
sDrive 16 d	85	11/18→10/23				24.4123-1733.3 011108	Ø 23,8 ohne Bremsflüssigkeitsbehälter
sDrive 18 d	100 - 110	03/18→10/23					
sDrive 18 i	100 - 103	03/18→10/23					
sDrive 20 d	120 - 140	11/18→10/23					
sDrive 20 i	131 - 141	11/17→10/23					
xDrive 18 d	100 - 110	03/18→10/23					
xDrive 20 d	120 - 140	11/17→10/23					
xDrive 20 i	131 - 141	03/18→10/23					
xDrive 25 d	170	11/17→09/23					
xDrive 25 e Plug-in-Hybrid	162	03/20→10/23					
BMW - X3 (E83) 01/03→12/11							
 Hauptbremszylinder							
2.0 d	110	09/04→08/07				24.2025-1710.3 010833	TRW Ø 25,4
2.0 i	110	07/05→08/08					
2.0 sd	130	09/07→08/08					
2.5 i	141	03/04→07/06					
2.5 si	160	08/06→08/08					
2.5 si xDrive	155	08/06→08/08					
3.0 d	150 - 160	01/04→08/08					
3.0 i xDrive	170	09/03→07/06					
3.0 sd	210	09/06→08/08					
3.0 si	194 - 200	08/06→08/08					
xDrive 20 d	120 - 130	09/08→08/10					
xDrive 25 i	155 - 160	09/08→08/10					
xDrive 30 d	155 - 160	09/08→08/10					
xDrive 30 i	160 - 200	08/06→08/10					
xDrive 18 d	100 - 105	09/08→12/11		→ 08/10		24.2025-1710.3 010833	TRW Ø 25,4
xDrive 20 i	110	09/08→08/11					
xDrive 35 d	210	09/08→08/11					
BMW - X3 (F25) 09/10→12/17							
 Hauptbremszylinder							
sDrive 18 d	100 - 110	10/12→08/17				24.4125-1709.3 011077	TRW Ø 25,4 ohne Bremsflüssigkeitsbehälter
sDrive 20 i	125 - 135	04/14→08/17					
xDrive 20 d	120 - 140	09/10→08/17					
xDrive 20 i	135	10/11→08/17					
xDrive 28 i	180 - 190	01/11→08/17					
→							















	kw			 	! #		
BMW - X3 (F25) 09/10→12/17							
 Hauptbremszylinder							
xDrive 30 d	155 - 210	04/11→08/17				24.4125-1709.3 011077	TRW Ø 25,4 ohne Bremsflüssigkeitsbehälter
xDrive 35 d	230	10/11→08/17					
xDrive 35 i	225	09/10→08/17					
BMW - X4 (F26) 05/13→03/18							
 Hauptbremszylinder							
xDrive 20 d	120 - 140	04/14→03/18				24.4125-1709.3 011077	TRW Ø 25,4 ohne Bremsflüssigkeitsbehälter
xDrive 20 i	135	04/14→03/18					
xDrive 28 i	179 - 180	04/14→03/18					
xDrive 30 d	155 - 210	04/14→03/18					
xDrive 35 d	230	04/14→03/18					
xDrive 35 i	225	04/14→03/18					
BMW - X5 (E53) 01/00→12/06							
 Hauptbremszylinder							
3.0 d	135	04/01→09/03		→ 08/01		24.2025-1704.3 010619	Ø 25,4
3.0 i	170	04/00→10/06				24.2025-1707.3 010691	Ø 25,4
4.4 i	210	01/00→09/03		09/01→			
3.0 d	155 - 160	10/03→09/06				24.2025-1707.3 010691	Ø 25,4
4.4 i	235	10/03→10/06					
4.6 is	255	10/01→09/03					
4.8 is	265	04/04→09/06					
BMW - Z3 Coupe (E36) 04/97→06/03							
 Bremskraftverstärker							
2.8 i	142	01/98→05/00				03.7760-3102.4 300139	ATE Ø 10" pneumatisch
3.0 i	170	06/00→06/03		→ 12/02		03.7760-3102.4 300139	ATE Ø 10" pneumatisch
BMW - Z3 Roadster (E36) 10/95→01/03							
 Bremskraftverstärker							
1.9 i	85 - 87	07/98→01/03		→ 12/02		03.7760-3102.4 300139	ATE Ø 10" pneumatisch
3.0 i	170	06/00→01/03					
2.0 i	110	04/99→01/03		→ 08/00		03.7760-3102.4 300139	ATE Ø 10" pneumatisch
2.2 i	120	08/00→01/03		10/00→ 12/02		03.7760-3102.4 300139	ATE Ø 10" pneumatisch
2.2 i	125	10/00→06/02				03.7760-3102.4 300139	ATE Ø 10" pneumatisch
2.5 i	141	10/00→08/02					
2.8 i	142	11/96→05/00					
BMW - Z4 Coupe (E86) 03/06→01/09							
 Bremskraftverstärker							
3.0 si	195	04/06→08/08				03.7860-0702.4 300123	ATE Ø 10" pneumatisch
 Hauptbremszylinder							
3.0 si	195	04/06→08/08				03.2023-2256.3 010870	ATE Ø1 23,8 Ø2 22,2
BMW - Z4 Roadster (E85) 09/02→12/09							
 Bremskraftverstärker							
2.0 i	110	03/05→02/09		04/05→ 12/08		03.7860-0702.4 300123	ATE Ø 10" pneumatisch
2.2 i	125	10/03→10/05				03.7860-0702.4 300123	ATE Ø 10" pneumatisch
2.5 i	141	12/02→12/05					
2.5 si	160	01/06→08/08					
3.0 i	170	12/02→12/05					
3.0 si	195	01/06→08/08					
2.5 i	130	09/05→02/09		01/06→ 12/08		03.7860-0702.4 300123	ATE Ø 10" pneumatisch
2.5 si	155	09/05→02/09					
 Hauptbremszylinder							
2.0 i	110	03/05→02/09		04/05→ 12/08		03.2023-2249.3 010869	ATE Ø1 23,8 Ø2 22,2
2.2 i	125	10/03→10/05				03.2023-2249.3 010869	ATE Ø1 23,8 Ø2 22,2
2.5 i	141	12/02→12/05					
3.0 i	170	12/02→12/05					
2.5 i	130	09/05→02/09		01/06→ 12/08		03.2023-2256.3 010870	ATE Ø1 23,8 Ø2 22,2
2.5 si	155	09/05→02/09					
2.5 si	160	01/06→08/08				03.2023-2256.3 010870	ATE Ø1 23,8 Ø2 22,2
3.0 si	195	01/06→08/08					

























	kw					! #		
BMW - Z4 Roadster (E89) 02/09→08/16								
 Hauptbremszylinder								
sDrive 18 i sDrive 20 i	115 120 - 135	04/13→08/16 09/11→08/16					03.2025-5826.3 010960	ATE Ø1 25,4 Ø2 22,2
sDrive 23 i sDrive 28 i sDrive 30 i	150 180 190 - 195	03/09→08/11 09/11→08/16 02/09→08/11						
sDrive 35 i sDrive 35 is	225 250	02/09→08/16 03/10→08/16						
BMW - Z8 Roadster (E52) 01/00→12/03								
 Hauptbremszylinder								
4.9	294	01/00→12/03					24.2026-1705.3 010992	TRW Ø 27 Ø2 20,6
CHEVROLET - ASTRA Schrägheck 09/98→12/11								
 Hauptbremszylinder								
2.0 DTi	74	08/02→12/11		→ 07/05; - ESP			24.2123-1734.3 010640	TRW Ø 23,8
				→ 07/05; + ESP			24.2123-1739.3 010661	Ø 23,8
 Bremskraftregler								
2.0 DTi	74	08/02→12/11		→ 07/05			03.6583-0085.3 320238	ATE lastabhängig 8/3 4x
CHEVROLET - ASTRA Stufenheck 10/98→12/11								
 Hauptbremszylinder								
2.0 DTi GLS	74	08/02→12/11		→ 07/05; - ESP			24.2123-1734.3 010640	TRW Ø 23,8
				→ 07/05; + ESP			24.2123-1739.3 010661	Ø 23,8
 Bremskraftregler								
2.0 DTi GLS	74	08/02→12/11		→ 07/05			03.6583-0085.3 320238	ATE lastabhängig 8/3 4x
CHEVROLET - AVEO Schrägheck (T300) 03/11→								
 Hauptbremszylinder								
1.2	51 - 63	03/11→		→ 03/12; für Linkslenker; + ABS; Felgenreöße [Zoll]: 14,0			24.4122-1735.3 011113	Ø 22,2 ohne Bremsflüssigkeitsbehälter
1.3 D	55 - 70	07/11→12/15		04/12→; für Linkslenker; + ESP; Felgenreöße [Zoll]: 15,0			24.4123-1738.3 011124	Ø 23,8 ohne Bremsflüssigkeitsbehälter
1.4	74	03/11→		→ 03/12; für Linkslenker; - ESP; Felgenreöße [Zoll]: 15,0			24.4123-1738.3 011124	Ø 23,8 ohne Bremsflüssigkeitsbehälter
1.6	85	03/11→						
1.2 LPG	63	11/12→12/15		für Linkslenker; + ESP; Felgenreöße [Zoll]: 15,0			24.4123-1738.3 011124	Ø 23,8 ohne Bremsflüssigkeitsbehälter
CHEVROLET - AVEO Stufenheck (T300) 03/11→								
 Hauptbremszylinder								
1.2	51 - 63	03/11→		→ 03/12; für Linkslenker; + ABS; Felgenreöße [Zoll]: 14,0			24.4122-1735.3 011113	Ø 22,2 ohne Bremsflüssigkeitsbehälter
1.3 D	55 - 70	07/11→12/15		04/12→; für Linkslenker; + ESP; Felgenreöße [Zoll]: 15,0			24.4123-1738.3 011124	Ø 23,8 ohne Bremsflüssigkeitsbehälter
1.4	74 - 103	07/11→		→ 03/12; für Linkslenker; - ESP; Felgenreöße [Zoll]: 15,0			24.4123-1738.3 011124	Ø 23,8 ohne Bremsflüssigkeitsbehälter
1.6	85	03/11→						
1.2 LPG	63	11/12→12/15		für Linkslenker; + ESP; Felgenreöße [Zoll]: 15,0			24.4123-1738.3 011124	Ø 23,8 ohne Bremsflüssigkeitsbehälter
CHEVROLET - CORSA Kombi 01/96→12/10								
 Hauptbremszylinder								
1.7 D	44	08/00→07/02		→ 09/00; für Linkslenker; - ABS			24.2120-0702.3 010361	nicht für Delco Ø 20,6
				→ 09/00; für Linkslenker; + ABS			24.2120-1714.3 010455	Ø 20,6
CHEVROLET - CRUZE (J300) 05/09→								
 Bremskraftverstärker								
1.4	74 - 103	09/10→		für Linkslenker			03.7858-0732.4 300272	ATE Ø 9 / 8" pneumatisch
1.6	80 - 91	05/09→						
1.7 D	96	01/12→						
1.7 TD	81	11/13→						
1.8	103 - 104	05/09→						
1.8 LPG	104	06/11→						
→								

	kw					! #		
CHEVROLET - CRUZE (J300) 05/09→								
 Bremskraftverstärker								
2.0 CDI	92	05/09→			für Linkslenker		03.7858-0732.4 300272	ATE Ø 9 / 8" pneumatisch
2.0 VCDi	120	03/12→11/18						
 Hauptbremszylinder								
1.4	74	07/13→			für Linkslenker; + ESP		03.2125-0421.3 010934	ATE Ø 25,4
1.6	80 - 91	05/09→			für Rechtslenker; + ESP		24.4155-0201.3 011125	ATE Ø 25,4 ohne Bremsflüssigkeitsbehälter
1.7 D	96	01/12→						
1.7 TD	81	11/13→						
1.8	103 - 104	05/09→						
1.8 LPG	104	06/11→						
2.0 CDI	92 - 120	05/09→						
2.0 VCDi	122	03/12→11/18						
1.4	103	09/10→			für Linkslenker; + ESP		03.2125-0421.3 010934	ATE Ø 25,4
1.6	86	12/12→			für Linkslenker; für Fahrzeuge mit elektr. Dämpferregulierung		03.2125-0421.3 010934	ATE Ø 25,4
CHEVROLET - CRUZE Schrägheck (J305) 12/10→								
 Bremskraftverstärker								
1.4	74	07/13→12/15			für Linkslenker		03.7858-0732.4 300272	ATE Ø 9 / 8" pneumatisch
1.6	80 - 91	06/11→						
1.7 D	96	01/12→12/15						
1.7 TD	81	08/13→12/15						
1.8	103 - 104	06/11→						
1.8 LPG	104	06/11→12/15						
2.0 CDI	120	06/11→						
1.4	103	06/12→			08/12→; für Linkslenker		03.7858-0732.4 300272	ATE Ø 9 / 8" pneumatisch
 Hauptbremszylinder								
1.4	74	07/13→12/15			für Linkslenker; + ESP		03.2125-0421.3 010934	ATE Ø 25,4
1.6	80 - 91	06/11→			für Rechtslenker; + ESP		24.4155-0201.3 011125	ATE Ø 25,4 ohne Bremsflüssigkeitsbehälter
1.7 D	96	01/12→12/15						
1.7 TD	81	08/13→12/15						
1.8	103 - 104	06/11→						
1.8 LPG	104	06/11→12/15						
2.0 CDI	120	06/11→						
1.4	103	06/12→			08/12→; für Linkslenker; + ESP		03.2125-0421.3 010934	ATE Ø 25,4
					08/12→; für Rechtslenker; + ESP		24.4155-0201.3 011125	ATE Ø 25,4 ohne Bremsflüssigkeitsbehälter
CHEVROLET - CRUZE Station Wagon (J308) 08/12→								
 Bremskraftverstärker								
1.4	74 - 103	08/12→			für Linkslenker		03.7858-0732.4 300272	ATE Ø 9 / 8" pneumatisch
1.6	86 - 91	08/12→12/15						
1.7 TD	81 - 96	08/12→						
1.8	104	08/12→						
2.0 TD	120	08/12→						
 Hauptbremszylinder								
1.4	74 - 103	08/12→			für Linkslenker; + ESP		03.2125-0421.3 010934	ATE Ø 25,4
1.6	86 - 91	08/12→12/15			für Rechtslenker; + ESP		24.4155-0201.3 011125	ATE Ø 25,4 ohne Bremsflüssigkeitsbehälter
1.7 TD	81 - 96	08/12→						
1.8	104	08/12→						
2.0 TD	120	08/12→						
CHEVROLET - MALIBU 01/08→								
 Bremskraftverstärker								
2.0	193	09/12→					03.7858-0732.4 300272	ATE Ø 9 / 8" pneumatisch
 Hauptbremszylinder								
2.0	193	09/12→					03.2125-0421.3 010934	ATE Ø 25,4

	kw			 	! #		
CHEVROLET - MALIBU (V300) 01/12→							
 Bremskraftverstärker							
2.0 2.0 D 2.4 3.0	193 115 - 118 123 - 125 196	01/12→12/15 04/12→ 01/12→ 04/13→				03.7858-0732.4 300272	ATE Ø 9 / 8" pneumatisch
 Hauptbremszylinder							
2.0 2.0 D 2.4 3.0	193 115 - 118 123 - 125 196	01/12→12/15 04/12→ 01/12→ 04/13→				03.2125-0421.3 010934	ATE Ø 25,4
CHEVROLET - MATIZ (M200, M250) 03/05→							
 Hauptbremszylinder							
0.8 0.8 LPG 1.0 1.0 LPG	37 38 47 49	10/10→ 03/05→12/07 03/05→12/07 03/05→03/11		→ 645871; + ABS 645872→; + ABS		24.2120-1755.3 010974 24.2120-1755.3 010974	Ø 20,6 ohne Bremsflüssigkeitsbehälter Ø 20,6 ohne Bremsflüssigkeitsbehälter
				→ 645871; - ABS 645872→; - ABS		24.2120-1765.3 011003 24.2120-1765.3 011003	Ø 20,6 ohne Bremsflüssigkeitsbehälter Ø 20,6 ohne Bremsflüssigkeitsbehälter
0.8 1.0	38 46 - 49	03/05→12/13 03/05→		645872→; → 12/10; + ABS → 645871; + ABS 645872→; → 12/10; - ABS → 645871; - ABS		24.2120-1755.3 010974 24.2120-1755.3 010974 24.2120-1765.3 011003 24.2120-1765.3 011003	Ø 20,6 ohne Bremsflüssigkeitsbehälter Ø 20,6 ohne Bremsflüssigkeitsbehälter Ø 20,6 ohne Bremsflüssigkeitsbehälter Ø 20,6 ohne Bremsflüssigkeitsbehälter
CHEVROLET - ORLANDO (J309) 12/10→							
 Bremskraftverstärker							
1.8 1.8 LPG 2.0 D 2.0 LPG	104 104 96 - 120 103	02/11→ 06/11→12/15 02/11→ 02/12→				03.7858-0732.4 300272	ATE Ø 9 / 8" pneumatisch
 Hauptbremszylinder							
1.4	103	06/12→		+ ESP		24.4155-0201.3 011125	ATE Ø 25,4 ohne Bremsflüssigkeitsbehälter
1.8 1.8 LPG 2.0 D 2.0 LPG	104 104 96 - 120 103	02/11→ 06/11→12/15 02/11→ 02/12→		+ ESP		03.2125-0421.3 010934	ATE Ø 25,4
CHEVROLET - SPARK 05/05→							
 Hauptbremszylinder							
0.8	37	05/05→02/10		645872→; für Linkslenker; Schaltgetriebe; + ABS → 645871; für Linkslenker; Schaltgetriebe; + ABS 645872→; für Linkslenker; Schaltgetriebe; - ABS → 645871; für Linkslenker; Schaltgetriebe; - ABS		24.2120-1755.3 010974 24.2120-1755.3 010974 24.2120-1765.3 011003 24.2120-1765.3 011003	Ø 20,6 ohne Bremsflüssigkeitsbehälter Ø 20,6 ohne Bremsflüssigkeitsbehälter Ø 20,6 ohne Bremsflüssigkeitsbehälter Ø 20,6 ohne Bremsflüssigkeitsbehälter
1.0 SX	44 - 49	05/05→		645872→; → 02/10; für Linkslenker; + ABS → 645871; für Linkslenker; + ABS 645872→; → 02/10; für Linkslenker; - ABS → 645871; für Linkslenker; - ABS		24.2120-1755.3 010974 24.2120-1755.3 010974 24.2120-1765.3 011003 24.2120-1765.3 011003	Ø 20,6 ohne Bremsflüssigkeitsbehälter Ø 20,6 ohne Bremsflüssigkeitsbehälter Ø 20,6 ohne Bremsflüssigkeitsbehälter Ø 20,6 ohne Bremsflüssigkeitsbehälter

	kw					! #		
CHEVROLET - SPARK Kasten/Schrägheck (M200, M250) 01/05→08/14								
 Hauptbremszylinder								
0.8	38	01/07→08/14		645872→; für Linkslenker; Schaltgetriebe; + ABS		24.2120-1755.3	010974	Ø 20,6 ohne Bremsflüssigkeitsbehälter
				→ 645871; für Linkslenker; Schaltgetriebe; + ABS		24.2120-1755.3	010974	Ø 20,6 ohne Bremsflüssigkeitsbehälter
				645872→; für Linkslenker; Schaltgetriebe; - ABS		24.2120-1765.3	011003	Ø 20,6 ohne Bremsflüssigkeitsbehälter
				→ 645871; für Linkslenker; Schaltgetriebe; - ABS		24.2120-1765.3	011003	Ø 20,6 ohne Bremsflüssigkeitsbehälter
CHEVROLET - TRAX 12/12→								
 Hauptbremszylinder								
1.4	103	12/12→		für Linkslenker		24.4123-1738.3	011124	Ø 23,8 ohne Bremsflüssigkeitsbehälter
1.4 AWD	103	12/12→						
1.4 LPG	103	04/13→						
1.6	85	12/12→						
1.6 D	100	11/14→12/15						
1.6 D AWD	100	11/14→12/15						
1.7 TD	96	12/12→						
1.7 TD AWD	96	12/12→						
1.8	103	03/13→						
1.8 AWD	103	03/13→						
CHEVROLET - VECTRA 03/96→11/06								
 Hauptbremszylinder								
2.2	108	04/02→04/04		für Linkslenker; + ESP		24.2125-1732.3	010827	TRW Ø 25,4
3.2	155	09/01→07/04						
CHRYSLER - DELTA 08/11→								
 Hauptbremszylinder								
1.4	88	08/11→				24.4123-1710.3	010866	BOS Ø 23,8 ohne Bremsflüssigkeitsbehälter
1.4 16V	103	08/11→						
1.6 D Multijet	88	08/11→						
2.0 D Multijet	121	08/11→						
CHRYSLER - VOYAGER / GRAND VOYAGER III (GS_, NS_) 01/95→03/01								
 Hauptbremszylinder								
2.0 i	98	01/95→03/01		für Fahrzeuge mit STC		24.2123-1781.3	011060	Ø 23,8 ohne Bremsflüssigkeitsbehälter
2.4 AWD	111	02/97→03/01						
2.4 i	111	01/95→03/01						
3.0	112	01/95→03/01						
3.3 i	116	01/95→03/01						
3.8 i AWD	122 - 131	01/95→03/01						
2.5 TD	85	01/95→03/01		für Fahrzeuge ohne STC		24.2123-1781.3	011060	Ø 23,8 ohne Bremsflüssigkeitsbehälter
2.5 TDiC AWD	85	10/95→03/01						
CHRYSLER - VOYAGER / GRAND VOYAGER IV (RG) 02/00→02/08								
 Hauptbremszylinder								
2.8 CRD	110	04/04→02/08		für Linkslenker; - ESP		24.2123-1781.3	011060	Ø 23,8 ohne Bremsflüssigkeitsbehälter
CHRYSLER - VOYAGER IV (RG, RS) 09/99→12/08								
 Hauptbremszylinder								
2.4	108	02/00→12/08		02/02→; für Linkslenker; - ESP		24.2126-1706.3	011062	Ø 26 ohne Bremsflüssigkeitsbehälter
				02/02→; für Linkslenker; + ESP		24.2126-1707.3	011061	Ø 26 ohne Bremsflüssigkeitsbehälter
2.4	111	04/03→12/07		für Linkslenker; - ESP		24.2126-1706.3	011062	Ø 26 ohne Bremsflüssigkeitsbehälter
3.3	128 - 131	02/00→12/08						
3.8	160	02/00→12/08		für Linkslenker; + ESP		24.2126-1707.3	011061	Ø 26 ohne Bremsflüssigkeitsbehälter
2.5 CRD	88	08/05→12/08		für Linkslenker; - ESP		24.2123-1781.3	011060	Ø 23,8 ohne Bremsflüssigkeitsbehälter
2.5 CRD	105	02/00→12/08		10/02→; für Linkslenker; - ESP		24.2123-1781.3	011060	Ø 23,8 ohne Bremsflüssigkeitsbehälter
				→ 09/02; für Linkslenker; - ESP		24.2126-1706.3	011062	Ø 26 ohne Bremsflüssigkeitsbehälter
				→ 09/02; für Linkslenker; + ESP		24.2126-1707.3	011061	Ø 26 ohne Bremsflüssigkeitsbehälter
3.3 AWD	128	02/00→12/08		für Linkslenker		24.2126-1706.3	011062	Ø 26 ohne Bremsflüssigkeitsbehälter
3.8 AWD	160	02/00→12/08						

	kw					! #		
CITROËN - BERLINGO / BERLINGO FIRST Großraumlimousine (MF_, GJK_, GFK_ 07/96→								
 Hauptbremszylinder								
1.1 i 1.4 i	44 55	07/96→05/08 07/96→12/11		Orga 08610→; → 03/08; - ABS		03.2123-2781.3 010631 24.2123-1714.3 010587	ATE Ø 23,8 BDX Ø 23,8	
				→Orga 08609; - ABS		24.2123-1710.3 010504	Ø 23,8	
				→Orga 08609; für Linkslenker; + ABS		24.2123-1713.3 010505	Ø 23,8	
				Orga 08610→; → 03/08; - ESP		24.2123-1715.3 010520	BDX Ø 23,8	
1.4 2.0 HDi 4x4 2.0 HDi 90 electrique	53 66 66 16	11/02→10/05 11/02→10/05 12/99→10/05 01/00→10/02		- ABS		03.2123-2781.3 010631 24.2123-1714.3 010587	ATE Ø 23,8 BDX Ø 23,8	
				- ESP		24.2123-1715.3 010520	BDX Ø 23,8	
1.4 bivalent 1.4 i bivalent 1.6 16V	48 55 80	11/02→12/11 04/03→10/08 10/00→12/11		→ 03/08; - ABS		03.2123-2781.3 010631 24.2123-1714.3 010587	ATE Ø 23,8 BDX Ø 23,8	
				→ 03/08; - ESP		24.2123-1715.3 010520	BDX Ø 23,8	
1.6 HDi 75 1.6 HDi 90	55 66	07/05→12/11 07/05→05/08						
1.6 HDi 92	68	11/09→12/10		- ABS		24.2123-1714.3 010587	BDX Ø 23,8	
				+ ABS / - ESP		24.2123-1715.3 010520	BDX Ø 23,8	
1.8 D 1.8 i 1.9 D	43 66 50	07/98→10/02 05/97→10/02 07/96→10/05		Orga 08610→; - ABS		03.2123-2781.3 010631 24.2123-1714.3 010587	ATE Ø 23,8 BDX Ø 23,8	
				→Orga 08609; - ABS		24.2123-1710.3 010504	Ø 23,8	
				→Orga 08609; für Linkslenker; + ABS		24.2123-1713.3 010505	Ø 23,8	
1.9 D 4WD	51	07/98→10/05		Orga 08610→; - ESP		24.2123-1715.3 010520	BDX Ø 23,8	
1.8 i 4WD	66	04/97→10/01		Orga 08610→; - ABS		03.2123-2781.3 010631 24.2123-1714.3 010587	ATE Ø 23,8 BDX Ø 23,8	
				05/97→; →Orga 08609; - ABS		24.2123-1710.3 010504	Ø 23,8	
				05/97→; →Orga 08609; für Linkslenker; + ABS		24.2123-1713.3 010505	Ø 23,8	
				Orga 08610→; - ESP		24.2123-1715.3 010520	BDX Ø 23,8	
Electric	28	01/98→12/05		11/02→; - ABS		03.2123-2781.3 010631 24.2123-1714.3 010587	ATE Ø 23,8 BDX Ø 23,8	
				11/02→; - ESP		24.2123-1715.3 010520	BDX Ø 23,8	
CITROËN - BERLINGO / BERLINGO FIRST Kasten/Großraumlimousine (M_) 07/96→12/11								
 Hauptbremszylinder								
1.1 i 1.4 BiFuel 1.8 D	44 55 43	07/96→03/08 07/96→10/02 07/96→10/02		Orga 08610→; - ABS		03.2123-2781.3 010631 24.2123-1714.3 010587	ATE Ø 23,8 BDX Ø 23,8	
				→Orga 08609; - ABS		24.2123-1710.3 010504	Ø 23,8	
1.9 D 1.9 D 70 4WD 2.0 HDi 90 4WD	51 51 66	07/96→12/03 07/98→03/06 11/00→10/05		→Orga 08609; + ABS; für Linkslenker		24.2123-1713.3 010505	Ø 23,8	
				Orga 08610→; + ABS		24.2123-1715.3 010520	BDX Ø 23,8	
1.4 bivalent 1.6 HDi 75	48 55	11/02→12/11 07/05→12/11		→ 03/08; - ABS		03.2123-2781.3 010631 24.2123-1714.3 010587	ATE Ø 23,8 BDX Ø 23,8	
				→ 03/08; + ABS		24.2123-1715.3 010520	BDX Ø 23,8	
1.4 i 1.9 D 70 2.0 HDi 90	55 51 66	07/96→12/11 04/99→12/11 12/99→12/11		Orga 08610→; → 03/08; - ABS		03.2123-2781.3 010631 24.2123-1714.3 010587	ATE Ø 23,8 BDX Ø 23,8	
				→Orga 08609; - ABS		24.2123-1710.3 010504	Ø 23,8	
				→Orga 08609; + ABS; für Linkslenker		24.2123-1713.3 010505	Ø 23,8	
				Orga 08610→; → 03/08; + ABS		24.2123-1715.3 010520	BDX Ø 23,8	
1.4 i bivalent 1.6 16V	55 80	04/03→10/05 10/00→03/08		- ABS		03.2123-2781.3 010631 24.2123-1714.3 010587	ATE Ø 23,8 BDX Ø 23,8	
				+ ABS		24.2123-1715.3 010520	BDX Ø 23,8	
1.6 HDi 92	68	11/09→12/10		- ABS		24.2123-1714.3 010587	BDX Ø 23,8	
				+ ABS / - ESP		24.2123-1715.3 010520	BDX Ø 23,8	
Electric	42	01/10→12/10		+ ESP		24.4123-1714.3 010979	TRW Ø 23,8	
				- ESP		24.4123-1742.3 011156	TRW Ø 23,8 ohne Bremsflüssigkeitsbehälter	
CITROËN - BERLINGO Kasten/Großraumlimousine (B9) 04/08→								
 Hauptbremszylinder								
1.6	66	04/08→		+ ESP		24.4123-1714.3 010979	TRW Ø 23,8	
1.6 BlueHdi 100 1.6 BlueHdi 100 4x4 1.6 BlueHdi 120 1.6 HDi 110	80 73 73 88	12/14→04/21 12/14→ 12/14→08/18		- ESP		24.4123-1742.3 011156	TRW Ø 23,8 ohne Bremsflüssigkeitsbehälter	
1.6 HDi 115	80 82	04/08→ 04/08→						
→	84	07/10→						

	kw					! #			
CITROËN - BERLINGO Kasten/Großraumlimousine (B9) 04/08→									
 Hauptbremszylinder									
1.6 HDi 115 4x4	84	02/12→		+ ESP		24.4123-1714.3	010979	TRW Ø 23,8	
1.6 HDi 75	55	04/08→		- ESP		24.4123-1742.3	011156	TRW Ø 23,8 ohne Bremsflüssigkeitsbehälter	
1.6 HDi 75 4x4	55	02/12→							
1.6 HDi 90	66 - 68	07/10→							
1.6 HDi 90 16V	66	04/08→							
1.6 HDi 90 4x4	66	02/12→							
1.6 VTi 120	88	11/09→							
1.6 VTi 95	72	07/10→							
1.6 HDi / BlueHDi 75	55	07/10→04/20		04/15→; + ESP		24.4123-1714.3	010979	TRW Ø 23,8	
				04/15→; - ESP		24.4123-1742.3	011156	TRW Ø 23,8 ohne Bremsflüssigkeitsbehälter	
Electric	35	01/13→		02/13→; + ESP		24.4123-1714.3	010979	TRW Ø 23,8	
				02/13→; - ESP		24.4123-1742.3	011156	TRW Ø 23,8 ohne Bremsflüssigkeitsbehälter	
Electric	49	01/13→		+ ESP		24.4123-1714.3	010979	TRW Ø 23,8	
				02/13→; - ESP		24.4123-1742.3	011156	TRW Ø 23,8 ohne Bremsflüssigkeitsbehälter	
PureTech 110	81	01/18→		+ ESP; →Orga 14685		24.4123-1714.3	010979	TRW Ø 23,8	
				- ESP; →Orga 14685		24.4123-1742.3	011156	TRW Ø 23,8 ohne Bremsflüssigkeitsbehälter	
CITROËN - BERLINGO MULTISPACE (B9) 04/08→									
 Hauptbremszylinder									
1.2 PureTech 110	81	02/16→		+ ESP		24.4123-1714.3	010979	TRW Ø 23,8	
1.6	66 - 81	04/08→		- ESP		24.4123-1742.3	011156	TRW Ø 23,8 ohne Bremsflüssigkeitsbehälter	
1.6 BlueHDi 100	73	12/14→04/21							
1.6 BlueHDi 120	88	12/14→08/18							
1.6 HDi 110	80 - 82	04/08→							
1.6 HDi 115	84	07/10→							
1.6 HDi 115 4x4	84	02/12→							
1.6 HDi 75 16V	55	04/08→							
1.6 HDi 90	66 - 68	04/08→							
1.6 HDi 90 4x4	66	02/12→12/14							
1.6 VTi 120	88	11/09→							
1.6 VTi 95	72	07/10→							
1.6 HDi 75 / BlueHDi 75	55	04/08→04/20		04/15→; + ESP		24.4123-1714.3	010979		TRW Ø 23,8
				04/15→; - ESP		24.4123-1742.3	011156		TRW Ø 23,8 ohne Bremsflüssigkeitsbehälter
Electric	49	09/17→		+ ESP; →Orga 14685		24.4123-1714.3	010979	TRW Ø 23,8	
				- ESP; →Orga 14685		24.4123-1742.3	011156	TRW Ø 23,8 ohne Bremsflüssigkeitsbehälter	
CITROËN - BERLINGO Pritsche/Fahrgestell (B9) 04/08→									
 Hauptbremszylinder									
1.6 BlueHDi 100	73	12/14→04/21		+ ESP		24.4123-1714.3	010979	TRW Ø 23,8	
1.6 HDi 90	66	07/10→		- ESP		24.4123-1742.3	011156	TRW Ø 23,8 ohne Bremsflüssigkeitsbehälter	
1.6 HDi 90 16V	66	04/08→							
1.6 HDi 92	68	07/10→12/17							
CITROËN - C1 (PM_, PN_) 06/05→09/14									
 Hauptbremszylinder									
1.0	50	06/05→09/14		für Linkslenker; → 04/14; - ESP		24.4120-1701.3	010846	BOS Ø 20,6	
				für Linkslenker; → 04/14; + ESP		24.4120-1704.3	011042	Ø 20,6 ohne Bremsflüssigkeitsbehälter	
				für Rechtslenker; → 04/14; + ESP		24.4120-1705.3	011051	Ø 20,6 ohne Bremsflüssigkeitsbehälter	
1.4 HDi	40	06/05→09/14		→ 12/08; für Linkslenker; - ESP		24.4120-1701.3	010846	BOS Ø 20,6	
				→ 12/08; für Linkslenker; + ESP		24.4120-1704.3	011042	Ø 20,6 ohne Bremsflüssigkeitsbehälter	
				→ 12/08; für Rechtslenker; + ESP		24.4120-1705.3	011051	Ø 20,6 ohne Bremsflüssigkeitsbehälter	
CITROËN - C1 II (PA_, PS_) 04/14→07/21									
 Hauptbremszylinder									
1.0 VTi 68	51	04/14→04/18		für Linkslenker; - ESP		24.4120-1712.3	011092	Ø 20,6 ohne Bremsflüssigkeitsbehälter	
1.0 VTi 72	53	06/18→07/21							
1.2 VTi 82	60	04/14→04/18							

CITROËN - C2 (JM_) 07/03→09/17

Hauptbremszylinder











1.1	44	09/03→09/12	→ 12/09; - ABS	24.2120-1741.3 010775	Ø 20,6
			10815→ 11192; für Linkslenker; - ESP	24.2122-1764.3 010851	BOS Ø 22,2
			→Orga 10800; - ESP	24.2122-1766.3 010840	TRW Ø 22,2
			→Orga 10800; + ESP	24.2122-1767.3 010841	TRW Ø 22,2 ohne Drucksensor
			→ 12/09; Orga 10801→; + ESP	24.4122-1703.3 010843	TRW Ø 22,2
			10801→ 11192; für Rechtslenker; - ESP	24.4122-1704.3 010847	TRW Ø 22,2
			10808→ 10810; für Linkslenker; - ESP	24.4122-1704.3 010847	TRW Ø 22,2
			10801→ 10807; für Linkslenker; - ESP	24.4122-1708.3 010865	BOS Ø 22,2 ohne Bremsflüssigkeitsbehälter
			10811→ 10814; für Linkslenker; - ESP	24.4122-1708.3 010865	BOS Ø 22,2 ohne Bremsflüssigkeitsbehälter
1.4 1.4 HDi	54 - 55 50 - 51	09/03→12/09 07/03→12/09	- ABS	24.2120-1741.3 010775	Ø 20,6
			10815→ 11192; für Linkslenker; - ESP	24.2122-1764.3 010851	BOS Ø 22,2
			→Orga 10800; - ESP	24.2122-1766.3 010840	TRW Ø 22,2
			→Orga 10800; + ESP	24.2122-1767.3 010841	TRW Ø 22,2 ohne Drucksensor
			Orga 10801→; + ESP	24.4122-1703.3 010843	TRW Ø 22,2
			Orga 10801→; für Rechtslenker; - ESP	24.4122-1704.3 010847	TRW Ø 22,2
			10808→ 10810; für Linkslenker; - ESP	24.4122-1704.3 010847	TRW Ø 22,2
			10801→ 10807; für Linkslenker; - ESP	24.4122-1708.3 010865	BOS Ø 22,2 ohne Bremsflüssigkeitsbehälter
			Orga 11193→; für Linkslenker; - ESP	24.4122-1708.3 010865	BOS Ø 22,2 ohne Bremsflüssigkeitsbehälter
1.4 16V	65	04/05→12/09	- ABS	24.2120-1741.3 010775	Ø 20,6
			10815→ 11192; für Linkslenker; - ESP	24.2122-1764.3 010851	BOS Ø 22,2
			Orga 10801→; + ESP	24.4122-1703.3 010843	TRW Ø 22,2
			Orga 10801→; für Rechtslenker; - ESP	24.4122-1704.3 010847	TRW Ø 22,2
			10808→ 10810; für Linkslenker; - ESP	24.4122-1704.3 010847	TRW Ø 22,2
			Orga 11193→; für Linkslenker; - ESP	24.4122-1708.3 010865	BOS Ø 22,2 ohne Bremsflüssigkeitsbehälter
			10801→ 10807; für Linkslenker; - ESP	24.4122-1708.3 010865	BOS Ø 22,2 ohne Bremsflüssigkeitsbehälter
1.6	80	07/03→10/10	→ 12/09; - ABS	24.2120-1741.3 010775	Ø 20,6
			→Orga 10800; - ESP	24.2122-1766.3 010840	TRW Ø 22,2
			→Orga 10800; + ESP	24.2122-1767.3 010841	TRW Ø 22,2 ohne Drucksensor
			→ 12/09; Orga 10801→; + ESP	24.4122-1703.3 010843	TRW Ø 22,2
			Orga 10801→; → 12/09; für Linkslenker; - ESP	24.4122-1704.3 010847	TRW Ø 22,2
1.6 HDi	80	09/05→12/09	Orga 10801→; + ESP	24.4122-1703.3 010843	TRW Ø 22,2
1.6 VTS	90	10/04→12/09	→Orga 10800; - ESP	24.2122-1766.3 010840	TRW Ø 22,2
			→Orga 10800; + ESP	24.2122-1767.3 010841	TRW Ø 22,2 ohne Drucksensor
			Orga 10801→; + ESP	24.4122-1703.3 010843	TRW Ø 22,2

CITROËN - C2 ENTERPRISE (JG_) 11/03→12/09









Hauptbremszylinder















1.1	44	11/03→12/09	- ABS	24.2120-1741.3 010775	Ø 20,6
			10815→ 11192; für Linkslenker; - ESP	24.2122-1764.3 010851	BOS Ø 22,2
			→Orga 10800; - ESP	24.2122-1766.3 010840	TRW Ø 22,2
			→Orga 10800; + ESP	24.2122-1767.3 010841	TRW Ø 22,2 ohne Drucksensor
			Orga 10801→; + ESP	24.4122-1703.3 010843	TRW Ø 22,2
			10808→ 10810; für Linkslenker; - ESP	24.4122-1704.3 010847	TRW Ø 22,2
			10801→ 11192; für Rechtslenker; - ESP	24.4122-1704.3 010847	TRW Ø 22,2
			10801→ 10807; für Linkslenker; - ESP	24.4122-1708.3 010865	BOS Ø 22,2 ohne Bremsflüssigkeitsbehälter
			10811→ 10814; für Linkslenker; - ESP	24.4122-1708.3 010865	BOS Ø 22,2 ohne Bremsflüssigkeitsbehälter
			Orga 11193→; für Linkslenker; - ESP	24.4122-1708.3 010865	BOS Ø 22,2 ohne Bremsflüssigkeitsbehälter













→













	kw					! #		
CITROËN - C2 ENTERPRISE (JG_) 11/03→12/09								
 Hauptbremszylinder								
1.4 HDi	50 - 51	11/03→12/09		- ABS		24.2120-1741.3 010775	Ø 20,6	
				10815→ 11192; für Linkslenker; - ESP	24.2122-1764.3 010851	BOS Ø 22,2		
				→Orga 10800; - ESP	24.2122-1766.3 010840	TRW Ø 22,2		
				→Orga 10800; + ESP	24.2122-1767.3 010841	TRW Ø 22,2 ohne Drucksensor		
				Orga 10801→; + ESP	24.4122-1703.3 010843	TRW Ø 22,2		
				Orga 10801→; für Rechtslenker; - ESP	24.4122-1704.3 010847	TRW Ø 22,2		
				10808→ 10810; für Linkslenker; - ESP	24.4122-1704.3 010847	TRW Ø 22,2		
				10801→ 10807; für Linkslenker; - ESP	24.4122-1708.3 010865	BOS Ø 22,2 ohne Bremsflüssigkeitsbehälter		
				Orga 11193→; für Linkslenker; - ESP	24.4122-1708.3 010865	BOS Ø 22,2 ohne Bremsflüssigkeitsbehälter		
			10811→ 10814; für Linkslenker; - ESP	24.4122-1708.3 010865	BOS Ø 22,2 ohne Bremsflüssigkeitsbehälter			
CITROËN - C3 / C3 ORIGIN III (SX) 07/16→								
 Hauptbremszylinder								
1.2 PureTech 82	61	05/18→		für Fahrzeuge mit Trommelbremse an der Hinterachse		24.4122-1703.3 010843	TRW Ø 22,2	
1.2 PureTech 82 LPG	61	05/18→						
1.2 THP 110	81	07/16→		für Fahrzeuge mit Scheibenbremse an der Hinterachse		24.4123-1704.3 010828	TRW Ø 23,8	
1.2 VTi 68	50	07/16→						
1.2 VTi 82	60	07/16→						
1.2 VTi 82 LPG	60	07/16→						
1.5 BlueHDi 100	75	05/18→						
1.6 BlueHDi 100	73	07/16→05/18						
1.6 BlueHDi 75	55	07/16→05/18						
1.6 VTi	85	02/17→						
CITROËN - C3 I (FC_, FN_) 02/02→12/13								
 Hauptbremszylinder								
1.1 i	44	02/02→12/09		→ 08/09; - ABS		24.2120-1741.3 010775	Ø 20,6	
1.4 HDi	50 - 55	02/02→02/11		Orga 10815→; → 08/09; für Linkslenker; - ESP	24.2122-1764.3 010851	BOS Ø 22,2		
1.4 i	54	02/02→11/10		→Orga 10800; für Linkslenker; - ESP	24.2122-1764.3 010851	BOS Ø 22,2		
				→Orga 10800; - ESP	24.2122-1766.3 010840	TRW Ø 22,2		
				→Orga 10800; + ESP	24.2122-1767.3 010841	TRW Ø 22,2 ohne Drucksensor		
				Orga 10801→; → 08/09; + ESP	24.4122-1703.3 010843	TRW Ø 22,2		
				10808→ 10814; für Linkslenker; - ESP	24.4122-1704.3 010847	TRW Ø 22,2		
				→ 08/09; für Rechtslenker; - ESP	24.4122-1704.3 010847	TRW Ø 22,2		
				10801→ 10807; für Linkslenker; - ESP	24.4122-1708.3 010865	BOS Ø 22,2 ohne Bremsflüssigkeitsbehälter		
1.1 LPG	44	06/06→12/09		- ABS	24.2120-1741.3 010775	Ø 20,6		
1.4	58	12/05→07/12		Orga 10815→; für Linkslenker; - ESP	24.2122-1764.3 010851	BOS Ø 22,2		
1.4 BiFuel	54	09/08→12/09		→Orga 10800; für Linkslenker; - ESP	24.2122-1764.3 010851	BOS Ø 22,2		
1.4 i Bivalent	49	01/08→12/09		→Orga 10800; - ESP	24.2122-1766.3 010840	TRW Ø 22,2		
				→Orga 10800; + ESP	24.2122-1767.3 010841	TRW Ø 22,2 ohne Drucksensor		
				Orga 10801→; + ESP	24.4122-1703.3 010843	TRW Ø 22,2		
				10808→ 10814; für Linkslenker; - ESP	24.4122-1704.3 010847	TRW Ø 22,2		
				für Rechtslenker; - ESP	24.4122-1704.3 010847	TRW Ø 22,2		
				10801→ 10807; für Linkslenker; - ESP	24.4122-1708.3 010865	BOS Ø 22,2 ohne Bremsflüssigkeitsbehälter		
1.4 16V	65	12/03→08/10		→ 08/09; - ABS	24.2120-1741.3 010775	Ø 20,6		
1.6 16V	80	02/02→08/10		→Orga 10800; für Linkslenker; - ESP	24.2122-1764.3 010851	BOS Ø 22,2		
				→Orga 10800; - ESP	24.2122-1766.3 010840	TRW Ø 22,2		
				→Orga 10800; + ESP	24.2122-1767.3 010841	TRW Ø 22,2 ohne Drucksensor		
				Orga 10801→; → 08/09; + ESP	24.4122-1703.3 010843	TRW Ø 22,2		
				→ 08/09; - ESP	24.4122-1704.3 010847	TRW Ø 22,2		
1.4 16V HDi	66	02/02→06/08		- ABS	24.2120-1741.3 010775	Ø 20,6		
				Orga 10815→; für Linkslenker; - ESP	24.2122-1764.3 010851	BOS Ø 22,2		
				→Orga 10800; für Linkslenker; - ESP	24.2122-1764.3 010851	BOS Ø 22,2		
				→Orga 10800; - ESP	24.2122-1766.3 010840	TRW Ø 22,2		
				→Orga 10800; + ESP	24.2122-1767.3 010841	TRW Ø 22,2 ohne Drucksensor		
				Orga 10801→; + ESP	24.4122-1703.3 010843	TRW Ø 22,2		
				- ESP	24.4122-1704.3 010847	TRW Ø 22,2		
				10801→ 10807; für Linkslenker; - ESP	24.4122-1708.3 010865	BOS Ø 22,2 ohne Bremsflüssigkeitsbehälter		
→								















	kw					! #		
CITROËN - C3 I (FC_, FN_) 02/02→12/13								
 Hauptbremszylinder								
1.4 i Bivalent	54	02/02→12/09		09/05→ 08/09; - ABS	24.2120-1741.3	010775	Ø 20,6	
				09/05→; →Orga 10800; für Linkslenker; - ESP	24.2122-1764.3	010851	BOS Ø 22,2	
				09/05→; →Orga 10800; - ESP	24.2122-1766.3	010840	TRW Ø 22,2	
				09/05→; →Orga 10800; + ESP	24.2122-1767.3	010841	TRW Ø 22,2 ohne Drucksensor	
				Orga 10801→; → 08/09; + ESP	24.4122-1703.3	010843	TRW Ø 22,2	
				09/05→ 08/09; für Linkslenker; - ESP	24.4122-1704.3	010847	TRW Ø 22,2	
1.6 16V	81	05/03→09/05		- ABS	24.2120-1741.3	010775	Ø 20,6	
				→Orga 10800; für Linkslenker; - ESP	24.2122-1764.3	010851	BOS Ø 22,2	
				→Orga 10800; - ESP	24.2122-1766.3	010840	TRW Ø 22,2	
				→Orga 10800; + ESP	24.2122-1767.3	010841	TRW Ø 22,2 ohne Drucksensor	
				Orga 10801→; + ESP	24.4122-1703.3	010843	TRW Ø 22,2	
				- ESP	24.4122-1704.3	010847	TRW Ø 22,2	
1.6 16V HDi	66	10/05→12/09		→Orga 10800; für Linkslenker; - ESP	24.2122-1764.3	010851	BOS Ø 22,2	
				→Orga 10800; - ESP	24.2122-1766.3	010840	TRW Ø 22,2	
				→Orga 10800; + ESP	24.2122-1767.3	010841	TRW Ø 22,2 ohne Drucksensor	
				Orga 10801→; → 08/09; + ESP	24.4122-1703.3	010843	TRW Ø 22,2	
				→ 08/09; - ESP	24.4122-1704.3	010847	TRW Ø 22,2	
1.6 16V HDi	80	09/05→12/09		→Orga 10800; für Linkslenker; - ESP	24.2122-1764.3	010851	BOS Ø 22,2	
				→Orga 10800; - ESP	24.2122-1766.3	010840	TRW Ø 22,2	
				→Orga 10800; + ESP	24.2122-1767.3	010841	TRW Ø 22,2 ohne Drucksensor	
				Orga 10801→; → 08/09; + ESP	24.4122-1703.3	010843	TRW Ø 22,2	
				→ 08/09; - ESP	24.4122-1704.3	010847	TRW Ø 22,2	
	10801→ 10807; für Linkslenker; - ESP	24.4122-1708.3	010865	BOS Ø 22,2 ohne Bremsflüssigkeitsbehälter				
CITROËN - C3 II (SC_) 09/09→								
 Hauptbremszylinder								
1.0 VTi 68	50	08/12→09/16		10/12→; + DSC	24.4122-1726.3	011096	Ø 22,2 ohne Bremsflüssigkeitsbehälter	
1.2 VTi 82	60	06/12→09/16						
1.1 BiFuel	44	11/10→09/16		Orga 13153→; + DSC	24.4122-1703.3	010843	TRW Ø 22,2	
1.1 i	44	09/09→01/13		Orga 13153→; - DSC	24.4122-1704.3	010847	TRW Ø 22,2	
1.4	54	11/09→09/16						
1.4 HDi 70	50	11/09→09/16		→Orga 13152; + DSC	24.4122-1726.3	011096	Ø 22,2 ohne Bremsflüssigkeitsbehälter	
1.4 LPG	54	07/10→09/16						
1.6 HDi 90	66	11/09→09/16						
1.2 THP 110	81	10/14→09/16		+ DSC	24.4123-1734.3	011130	Ø 23,8 ohne Bremsflüssigkeitsbehälter	
				- DSC	24.4123-1735.3	011131	Ø 23,8 ohne Bremsflüssigkeitsbehälter	
1.4 LPG	70	06/13→09/16		Trommelbremse; + DSC	24.4122-1726.3	011096	Ø 22,2 ohne Bremsflüssigkeitsbehälter	
1.4 VTi 1.4 VTi 95	72 70	11/09→09/16 11/09→09/16		→Orga 13152; Trommelbremse; + DSC	24.4122-1726.3	011096	Ø 22,2 ohne Bremsflüssigkeitsbehälter	
				Orga 13153→; + DSC	24.4123-1704.3	010828	TRW Ø 23,8	
				Orga 13153→; - DSC	24.4123-1705.3	010832	TRW Ø 23,8	
				→Orga 13152; Scheibenbremse; + DSC	24.4123-1734.3	011130	Ø 23,8 ohne Bremsflüssigkeitsbehälter	
				→Orga 13152; Scheibenbremse; - DSC	24.4123-1735.3	011131	Ø 23,8 ohne Bremsflüssigkeitsbehälter	
1.6 BlueHDi 100 1.6 BlueHDi 75	73 55	07/14→09/16 04/15→09/16		+ DSC	24.4122-1703.3	010843	TRW Ø 22,2	
				- DSC	24.4122-1704.3	010847	TRW Ø 22,2	
1.6 HDi	68	11/09→09/16		Orga 13153→; Trommelbremse; + DSC	24.4122-1703.3	010843	TRW Ø 22,2	
				Orga 13153→; Trommelbremse; - DSC	24.4122-1704.3	010847	TRW Ø 22,2	
				→Orga 13152; Trommelbremse; + DSC	24.4122-1726.3	011096	Ø 22,2 ohne Bremsflüssigkeitsbehälter	
				Orga 13153→; Scheibenbremse; + DSC	24.4123-1704.3	010828	TRW Ø 23,8	
				Orga 13153→; Scheibenbremse; - DSC	24.4123-1705.3	010832	TRW Ø 23,8	
				→Orga 13152; Scheibenbremse; + DSC	24.4123-1734.3	011130	Ø 23,8 ohne Bremsflüssigkeitsbehälter	
				→Orga 13152; Scheibenbremse; - DSC	24.4123-1735.3	011131	Ø 23,8 ohne Bremsflüssigkeitsbehälter	
1.6 HDi 110 1.6 HDi 115 →	82 84	11/09→09/16 09/12→09/16		Orga 13153→; + DSC	24.4123-1704.3	010828	TRW Ø 23,8	













	kw			 	! #		
CITROËN - C3 II (SC_) 09/09→							
 Hauptbremszylinder							
1.6 VTi 120	88	11/09→09/16		Orga 13153→; - DSC		24.4123-1705.3 010832	TRW Ø 23,8
				→Orga 13152; + DSC		24.4123-1734.3 011130	Ø 23,8 ohne Bremsflüssigkeitsbehälter
				→Orga 13152; - DSC		24.4123-1735.3 011131	Ø 23,8 ohne Bremsflüssigkeitsbehälter
CITROËN - C3 II Kasten/Schrägheck (SC_) 06/10→							
 Hauptbremszylinder							
1.4 HDi	50	06/10→09/16		Orga 13153→; + DSC		24.4122-1703.3 010843	TRW Ø 22,2
				Orga 13153→; - DSC		24.4122-1704.3 010847	TRW Ø 22,2
				→Orga 13152; + DSC		24.4122-1726.3 011096	Ø 22,2 ohne Bremsflüssigkeitsbehälter
1.6 BlueHDi	55	03/15→09/16		+ DSC		24.4122-1703.3 010843	TRW Ø 22,2
				- DSC		24.4122-1704.3 010847	TRW Ø 22,2
CITROËN - C3 III Van (SX_, SY_) 07/16→							
 Hauptbremszylinder							
1.2 VTi BlueHDi 100	60 73 - 03/19→ 75	07/16→ 03/19→		für Fahrzeuge mit Trommelbremse an der Hinterachse		24.4122-1703.3 010843	TRW Ø 22,2
BlueHDi 75 PureTech 110 PureTech 82	55 81 61	03/19→ 03/19→ 03/19→		für Fahrzeuge mit Scheibenbremse an der Hinterachse		24.4123-1704.3 010828	TRW Ø 23,8
CITROËN - C3 AIRCROSS II (2R_, 2C_) 06/17→							
 Hauptbremszylinder							
1.2 PureTech 110 1.2 PureTech 130 1.2 PureTech 82 1.5 BlueHDi 100 1.5 BlueHDi 110 1.5 BlueHDi 120 1.6 BlueHDi 100 1.6 BlueHDi 115 1.6 BlueHDi 120 1.6 HDi 92	81 96 60 73 - 08/18→ 75 81 88 73 85 88 68	06/17→ 07/17→ 06/17→ 08/18→ 10/20→ 08/18→ 07/17→08/18 06/17→05/18 07/17→05/18 10/17→				24.4123-1704.3 010828	TRW Ø 23,8
CITROËN - C3 AIRCROSS II Van (2C_, 2R_) 06/17→							
 Hauptbremszylinder							
1.5 BlueHDi 100 1.5 BlueHDi 120 1.6 BlueHDi 100 PureTech 82	73 88 73 60 - 05/19→ 81	05/19→ 05/19→ 05/19→ 05/19→				24.4123-1704.3 010828	TRW Ø 23,8
CITROËN - C3 PICASSO (SH_) 12/08→							
 Hauptbremszylinder							
1.2 THP 110 1.4 VTi 95 1.4 VTi 95 LPG 1.6 BlueHDi 100 1.6 HDi 1.6 HDi 110 1.6 HDi 115 1.6 HDi 90 1.6 VTi 115 1.6 VTi 120	81 70 70 73 66 - 02/09→03/15 80 82 84 68 84 88	01/15→12/15 12/08→12/15 09/10→11/15 01/15→08/17 02/09→03/15 05/10→02/13 01/13→03/15 07/10→03/15 07/09→12/15 02/09→07/15		+ ESP - ESP		24.4123-1704.3 010828 24.4123-1705.3 010832	TRW Ø 23,8 TRW Ø 23,8
CITROËN - C3 Pluriel (HB_) 05/03→							
 Hauptbremszylinder							
1.4 1.4 HDi	54 55 50	05/03→ 04/04→		→ 07/10; - ABS →Orga 10800; - ESP		24.2120-1741.3 010775 24.2122-1764.3 010851 24.2122-1766.3 010840	Ø 20,6 BOS Ø 22,2 TRW Ø 22,2
				→Orga 10800; + ESP		24.2122-1767.3 010841	TRW Ø 22,2 ohne Drucksensor
				Orga 10801→; → 07/10; + ESP		24.4122-1703.3 010843	TRW Ø 22,2
				Orga 10801→; → 07/10; - ESP		24.4122-1704.3 010847	TRW Ø 22,2
1.6 →	80	05/03→		→ 07/10; - ABS →Orga 10800; - ESP		24.2120-1741.3 010775 24.2122-1764.3 010851	Ø 20,6 BOS Ø 22,2













	kw			 	! #		
CITROËN - C3 Pluriel (HB_) 05/03→							
 Hauptbremszylinder							
1.6	80	05/03→		→Orga 10800; - ESP	24.2122-1766.3 010840		TRW Ø 22,2
					24.2122-1767.3 010841		TRW Ø 22,2 ohne Drucksensor
				Orga 10801→; → 07/10; + ESP	24.4122-1703.3 010843		TRW Ø 22,2
				Orga 10801→; → 07/10; - ESP	24.4122-1704.3 010847		TRW Ø 22,2
CITROËN - C4 I (LC_) 11/04→12/14							
 Hauptbremszylinder							
1.4 16V 1.6 16V 1.6 16V Bio-Flex 1.6 HDi	65 80 80 66 - 85	11/04→07/11 11/04→07/11 09/07→07/08 11/04→07/11		Orga 11193→; - ESP	24.4123-1730.3 011097		Ø 23,8 ohne Bremsflüssigkeitsbehälter
				Orga 11193→; + ESP	24.4123-1741.3 011151		BOS Ø 23,8 ohne Bremsflüssigkeitsbehälter
1.6 HDi	80 - 84	04/10→11/12		- ESP	24.4123-1730.3 011097		Ø 23,8 ohne Bremsflüssigkeitsbehälter
1.6 THP 140 1.6 THP 150 1.6 VTi 120	103 110 88	07/08→07/11 07/08→07/11 07/08→07/11		- ESP	24.4123-1730.3 011097		Ø 23,8 ohne Bremsflüssigkeitsbehälter
				+ ESP	24.4123-1741.3 011151		BOS Ø 23,8 ohne Bremsflüssigkeitsbehälter
2.0 16V	103 - 130	11/04→07/11		Orga 11242→; - ESP	24.4123-1730.3 011097		Ø 23,8 ohne Bremsflüssigkeitsbehälter
				Orga 11193→; + ESP	24.4123-1741.3 011151		BOS Ø 23,8 ohne Bremsflüssigkeitsbehälter
2.0 HDi	100 - 103	11/04→07/11		Orga 11193→; + ESP	24.4123-1741.3 011151		BOS Ø 23,8 ohne Bremsflüssigkeitsbehälter
CITROËN - C4 I Kasten/Schrägheck (LR_) 02/05→12/10							
 Hauptbremszylinder							
2.0 HDi	100	02/05→12/10		Orga 11193→; + ESP	24.4123-1741.3 011151		BOS Ø 23,8 ohne Bremsflüssigkeitsbehälter
CITROËN - C4 I Stufenheck 07/06→11/14							
 Hauptbremszylinder							
1.6 1.6 16V 1.6 HDi	81 80 80 - 85	03/11→11/14 07/06→07/11 07/06→08/13		Orga 11193→; - ESP	24.4123-1730.3 011097		Ø 23,8 ohne Bremsflüssigkeitsbehälter
				Orga 11193→; + ESP	24.4123-1741.3 011151		BOS Ø 23,8 ohne Bremsflüssigkeitsbehälter
1.6 HDi	80 - 84	04/10→11/12		- ESP	24.4123-1730.3 011097		Ø 23,8 ohne Bremsflüssigkeitsbehälter
2.0 16V	103	07/06→07/11		Orga 11242→; - ESP	24.4123-1730.3 011097		Ø 23,8 ohne Bremsflüssigkeitsbehälter
				Orga 11193→; + ESP	24.4123-1741.3 011151		BOS Ø 23,8 ohne Bremsflüssigkeitsbehälter
CITROËN - C4 II (NC_) 02/09→							
 Hauptbremszylinder							
1.2 THP 110 1.2 THP 130 1.4 VTi 95 1.6 1.6 BlueHDi 100 1.6 BlueHDi 115 1.6 BlueHDi 120 1.6 HDi 110 1.6 HDi 115 1.6 HDi 90 1.6 THP 155 1.6 VTi 120 1.6 VTi 120 LPG 2.0 HDi / BlueHDi 150 2.0 HDi / BlueHDi 160	81 96 70 81 73 85 88 82 84 68 115 88 88 110 120	02/15→12/17 04/14→12/17 11/09→11/15 01/10→ 07/14→05/18 01/13→05/15 02/15→05/18 11/09→ 07/12→ 11/09→ 11/09→12/16 11/09→12/16 09/11→ 11/09→ 10/10→		+ DSC - DSC	24.4123-1726.3 011099 24.4123-1739.3 011150		Ø 23,8 ohne Bremsflüssigkeitsbehälter BOS Ø 23,8 ohne Bremsflüssigkeitsbehälter
CITROËN - C4 II Kasten/Schrägheck (NC_) 11/09→							
 Hauptbremszylinder							
1.6 BlueHDi	73 - 88	07/14→		+ DSC	24.4123-1726.3 011099		Ø 23,8 ohne Bremsflüssigkeitsbehälter
1.6 HDi	68 - 82	11/09→		- DSC	24.4123-1739.3 011150		BOS Ø 23,8 ohne Bremsflüssigkeitsbehälter















	kw					! #		
CITROËN - C4 II Stufenheck (NC_) 01/13→								
 Hauptbremszylinder								
1.6	85	01/13→			+ DSC		24.4123-1726.3 011099	Ø 23,8 ohne Bremsflüssigkeitsbehälter
1.6 HDi	84	08/13→			- DSC		24.4123-1739.3 011150	BOS Ø 23,8 ohne Bremsflüssigkeitsbehälter
1.6 THP	110	01/13→						
CITROËN - C4 CACTUS 09/14→								
 Hauptbremszylinder								
1.2 PureTech 130	96	11/17→			für Fahrzeuge mit Trommelbremse an der Hinterachse		24.4122-1703.3 010843	TRW Ø 22,2
1.2 THP 110	81	09/14→						
1.2 VTi 75 / PureTech 75	55	09/14→			für Fahrzeuge mit Scheibenbremse an der Hinterachse		24.4123-1704.3 010828	TRW Ø 23,8
1.2 VTi 82	60	09/14→						
1.5 BlueHDi 100	73	06/18→						
	75							
1.5 BlueHDi 120	88	09/18→						
1.6 BlueHDi 100	73	09/14→06/18						
1.6 HDi 90	68	09/14→						
CITROËN - C4 CACTUS Van (0B_, 0P_) 09/14→								
 Hauptbremszylinder								
BlueHDi 100	73	05/19→			für Fahrzeuge mit Trommelbremse an der Hinterachse		24.4122-1703.3 010843	TRW Ø 22,2
PureTech 110	81	05/19→						
PureTech 130	96	05/19→			für Fahrzeuge mit Scheibenbremse an der Hinterachse		24.4123-1704.3 010828	TRW Ø 23,8
PureTech 82	60	05/19→						
CITROËN - C4 Coupe (LA_) 11/04→12/13								
 Hauptbremszylinder								
1.4 16V	65	11/04→07/11			Orga 11193→; - ESP		24.4123-1730.3 011097	Ø 23,8 ohne Bremsflüssigkeitsbehälter
1.6 16V	80	11/04→07/11						
1.6 HDi	66 - 80	11/04→07/11			Orga 11193→; → 07/10; + ESP		24.4123-1741.3 011151	BOS Ø 23,8 ohne Bremsflüssigkeitsbehälter
1.6 THP	103	06/08→07/11			- ESP		24.4123-1730.3 011097	Ø 23,8 ohne Bremsflüssigkeitsbehälter
					07/08→ 07/10; + ESP		24.4123-1741.3 011151	BOS Ø 23,8 ohne Bremsflüssigkeitsbehälter
1.6 THP 150	110	07/08→07/11			- ESP		24.4123-1730.3 011097	Ø 23,8 ohne Bremsflüssigkeitsbehälter
1.6 VTi 120	88	07/08→07/11			→ 07/10; + ESP		24.4123-1741.3 011151	BOS Ø 23,8 ohne Bremsflüssigkeitsbehälter
2.0 16V	130	11/04→12/10			Orga 11242→; - ESP		24.4123-1730.3 011097	Ø 23,8 ohne Bremsflüssigkeitsbehälter
					Orga 11193→; → 07/10; + ESP		24.4123-1741.3 011151	BOS Ø 23,8 ohne Bremsflüssigkeitsbehälter
2.0 HDi	100 - 103	11/04→07/11			Orga 11193→; → 07/10; + ESP		24.4123-1741.3 011151	BOS Ø 23,8 ohne Bremsflüssigkeitsbehälter
2.0 VTR	103 - 105	10/06→07/08			Orga 11242→; - ESP		24.4123-1730.3 011097	Ø 23,8 ohne Bremsflüssigkeitsbehälter
					Orga 11193→; + ESP		24.4123-1741.3 011151	BOS Ø 23,8 ohne Bremsflüssigkeitsbehälter
CITROËN - C4 GRAND PICASSO I (UA_) 10/06→12/13								
 Bremskraftverstärker								
1.6 16V	103 - 110	07/08→08/13					03.7860-4034.4 300318	ATE Ø 10" pneumatisch
1.6 HDi	80	10/06→06/11						
1.6 HDi 110	82	09/10→08/13						
1.6 THP 155	115	09/10→08/13						
1.6 VTi 120	88	07/08→08/13						
2.0 HDi 138	100	10/06→12/13						
2.0 HDi 150	110	07/09→08/13						
2.0 HDi 165	120	09/10→08/13						
1.8 i 16V	92	10/06→12/10					03.7870-1002.4 300282	ATE Ø 11" pneumatisch
1.8 i 16V CNG	86	03/09→12/11						
1.8 i 16V Flex	86	06/09→01/13						
2.0 i 16V	103 - 105	10/06→12/13			→ 07/13		03.7870-1002.4 300282	ATE Ø 11" pneumatisch
 Hauptbremszylinder								
1.6 16V	103	07/08→12/10					03.4153-0173.3 010815	ATE Ø 23,8
1.6 HDi	80	10/06→06/11						
1.8 i 16V	92	10/06→12/10						
1.8 i 16V CNG	86	03/09→12/11						
1.8 i 16V Flex	86	06/09→01/13						
→								























	kw					! #		
CITROËN - C4 GRAND PICASSO I (UA_) 10/06→12/13								
 Hauptbremszylinder								
1.6 16V	110	10/08→08/13			→ 07/13		03.4153-0173.3 010815	ATE Ø 23,8
1.6 HDi 110	82	09/10→08/13						
1.6 VTi 120	88	07/08→08/13						
2.0 HDi 138	100	10/06→12/13						
2.0 HDi 150	110	07/09→08/13						
2.0 i 16V	103 - 105	10/06→12/13						
1.6 THP 155	115	09/10→08/13			11/10→ 07/13		03.4153-0173.3 010815	ATE Ø 23,8
2.0 HDi 165	120	09/10→08/13						
CITROËN - C4 GRAND PICASSO II (DA_, DE_) 06/13→								
 Hauptbremszylinder								
1.2 THP 130	96	04/14→					24.4155-1311.3 011053	ATE Ø 25,4 ohne Bremsflüssigkeitsbehälter
1.6 BlueHDi 100	73	01/15→04/16						
1.6 BlueHDi 120	88	07/14→12/18						
1.6 HDi / BlueHDi 115	85	09/13→04/15						
1.6 HDi 90	68	09/13→						
1.6 THP 150	110	09/14→						
1.6 THP 155	115	09/13→						
1.6 THP 165	121	07/14→						
1.6 VTi 120	88	09/13→						
2.0 BlueHDi 135	100	09/13→						
2.0 BlueHDi 150	110	06/13→			09/13→		24.4155-1311.3 011053	ATE Ø 25,4 ohne Bremsflüssigkeitsbehälter
CITROËN - C4 PICASSO I Großraumlimousine (UD_) 10/06→12/15								
 Bremskraftverstärker								
1.6 16V	110	07/08→08/13					03.7860-4034.4 300318	ATE Ø 10" pneumatisch
1.6 HDi	80	02/07→08/13						
1.6 HDi 110	82	09/10→08/13						
1.6 THP 140	103	07/08→08/13						
1.6 THP 155	115	09/10→08/13						
1.6 VTi 120	88	07/08→08/13						
2.0 HDi 138	100	10/06→08/13						
2.0 HDi 150	110	07/09→08/13						
2.0 HDi 165	120	09/10→08/13						
1.8 Bifuel	92	01/09→10/12					03.7870-1002.4 300282	ATE Ø 11" pneumatisch
1.8 i 16V	92	02/07→12/11						
2.0 i 16V	105	05/08→05/13						
2.0 i 16V	103	09/07→08/13			→ 07/13		03.7870-1002.4 300282	ATE Ø 11" pneumatisch
 Hauptbremszylinder								
1.6 16V	110	07/08→08/13			→ 07/13		03.4153-0173.3 010815	ATE Ø 23,8
1.6 HDi	80	02/07→08/13						
1.6 THP 140	103	07/08→08/13						
1.6 VTi 120	88	07/08→08/13						
2.0 HDi 150	110	07/09→08/13						
2.0 i 16V	103	09/07→08/13						
1.6 HDi 110	82	09/10→08/13			11/10→ 07/13		03.4153-0173.3 010815	ATE Ø 23,8
1.6 THP 155	115	09/10→08/13						
2.0 HDi 165	120	09/10→08/13						
1.8 Bifuel	92	01/09→10/12					03.4153-0173.3 010815	ATE Ø 23,8
1.8 i 16V	92	02/07→12/11						
2.0 i 16V	105	05/08→05/13						
2.0 HDi 138	100	10/06→08/13			02/07→ 07/13		03.4153-0173.3 010815	ATE Ø 23,8
CITROËN - C4 PICASSO II 01/13→								
 Hauptbremszylinder								
1.2 THP 110	81	04/16→					24.4155-1311.3 011053	ATE Ø 25,4 ohne Bremsflüssigkeitsbehälter
1.2 THP 130	96	04/14→						
1.6 BlueHDi 100	73	12/14→12/18						
1.6 BlueHDi 120	88	07/14→12/18						
1.6 THP 150	110	09/14→						
1.6 THP 165	121	07/14→						
1.6 VTi 120	88	02/13→						
2.0 BlueHDi 135	100	09/13→						
2.0 BlueHDi 150	110	09/13→						
1.6 HDi / BlueHDi 115	85	02/13→04/15			06/13→		24.4155-1311.3 011053	ATE Ø 25,4 ohne Bremsflüssigkeitsbehälter
1.6 HDi 90	68	02/13→						
1.6 THP 155	115	02/13→						
CITROËN - C4 PICASSO II Van (DD_) 01/13→								
 Hauptbremszylinder								
BlueHDi 150	110	09/13→					24.4155-1311.3 011053	ATE Ø 25,4 ohne Bremsflüssigkeitsbehälter
THP 155	115	02/13→						
VTi 120	88	02/13→						
→								

	kw					! #		
CITROËN - C4 PICASSO II Van (DD_) 01/13→								
 Hauptbremszylinder								
e-HDi HDi / e-HDi	85 68	02/13→ 02/13→		08/13→		24.4155-1311.3	011053	ATE Ø 25,4 ohne Bremsflüssigkeitsbehälter
CITROËN - C4 SPACETOURER (3D_) 04/18→								
 Hauptbremszylinder								
1.2 PureTech 110 1.2 PureTech 130 1.5 BlueHDi 130 1.6 BlueHDi 100 1.6 BlueHDi 120 1.6 THP 165 2.0 BlueHDi 150 2.0 BlueHDi 160	81 96 96 73 88 121 110 120	04/18→ 04/18→ 05/18→ 04/18→04/19 04/18→04/19 04/18→ 04/18→ 04/18→				24.4155-1311.3	011053	ATE Ø 25,4 ohne Bremsflüssigkeitsbehälter
CITROËN - C4 SPACETOURER Van (3D_) 04/18→								
 Hauptbremszylinder								
BlueHDi 120 BlueHDi 130 PureTech 130	88 96 96	05/19→ 05/19→ 05/19→				24.4155-1311.3	011053	ATE Ø 25,4 ohne Bremsflüssigkeitsbehälter
CITROËN - C5 III (RD_) 02/08→05/17								
 Bremskraftverstärker								
1.6 1.6 HDi 110 1.6 THP 150 1.6 THP 155 1.6 VTi 120 1.8 16V 2.0 16V 2.0 16V BioFlex 2.0 HDi 2.0 HDi 140 2.0 HDi 165 2.2 HDi 2.2 HDi 200 2.7 HDi 3.0 HDi 240 3.0 V6	120 80 110 115 88 92 103 - 105 103 100 - 101 103 120 120 - 125 150 150 177 155	03/11→06/14 02/08→10/10 07/10→07/16 04/09→07/16 07/10→06/15 02/08→10/10 02/08→10/14 02/08→12/12 02/08→05/17 11/08→06/15 04/09→07/16 02/08→12/11 07/10→06/15 02/08→12/09 04/09→10/14 02/08→12/10		für Linkslenker		03.7860-7802.4	300280	ATE Ø 10" pneumatisch
1.6 HDi 110 1.6 HDi 115 2.0 HDi 180	82 84 133	07/10→05/12 01/12→06/15 03/15→05/17		für Linkslenker; für Fahrzeuge ohne Start-Stopp-Funktion		03.7860-7802.4	300280	ATE Ø 10" pneumatisch
 Hauptbremszylinder								
1.6 1.6 HDi 110 1.6 THP 150 1.6 THP 155 1.6 VTi 120 1.8 16V 2.0 16V 2.0 16V BioFlex 2.0 HDi 2.0 HDi 140 2.0 HDi 165 2.2 HDi 2.2 HDi 200 2.7 HDi 3.0 HDi 240 3.0 V6	120 80 - 82 110 115 88 92 103 - 105 103 100 - 101 103 120 120 - 125 150 150 177 155	03/11→06/14 02/08→05/12 07/10→07/16 04/09→07/16 07/10→06/15 02/08→10/10 02/08→10/14 02/08→12/12 02/08→05/17 11/08→06/15 04/09→07/16 02/08→12/11 07/10→06/15 02/08→12/09 04/09→10/14 02/08→12/10		Orga 12348→		24.2123-3131.3	011123	ATE Ø 23,8
1.6 HDi 115 2.0 HDi 150 / BlueHDi 150 2.0 HDi 180	84 110 133	01/12→06/15 04/09→05/17 03/15→05/17				24.2123-3131.3	011123	ATE Ø 23,8
CITROËN - C5 III Break (RW_) 02/08→05/17								
 Bremskraftverstärker								
1.6 HDi 110 1.6 HDi 115 2.0 HDi 180	82 84 133	07/10→05/12 06/12→06/15 03/15→05/17		für Linkslenker; für Fahrzeuge ohne Start-Stopp-Funktion		03.7860-7802.4	300280	ATE Ø 10" pneumatisch
1.6 HDi 110	80	02/08→10/10		für Linkslenker		03.7860-7802.4	300280	ATE Ø 10" pneumatisch

	kw			 	! #		
CITROËN - C5 III Break (RW_) 02/08→05/17							
 Bremskraftverstärker							
1.6 THP 150	110	04/09→07/16		für Linkslenker		03.7860-7802.4 300280	ATE Ø 10" pneumatisch
1.6 THP 155	115	04/09→07/16					
1.6 VTI 120	88	07/10→06/15					
1.8 i 16V	92	02/08→10/10					
2.0 16V	105	04/08→12/12					
2.0 16V BioFlex	103	02/08→06/10					
2.0 HDi	100	02/08→06/14					
2.0 HDi 140	103	04/09→06/15					
2.0 HDi 150 / BlueHDi 150	110	04/09→05/17					
2.0 HDi 165	120	04/09→07/16					
2.0 i 16V	103	02/08→10/14					
2.2 HDi	125	02/08→12/11					
2.2 HDi 165	120	02/08→08/09					
2.2 HDi 200	150	07/10→06/15					
2.7 HDi	150	02/08→10/09					
3.0 HDi 240	177	04/09→10/14					
3.0 V6	155	02/08→12/10					
 Hauptbremszylinder							
1.6 HDi 110	82	07/10→05/12		Orga 12348→		24.2123-3131.3 011123	ATE Ø 23,8
1.6 HDi 115	84	06/12→06/15					
1.6 THP 150	110	04/09→07/16					
1.6 THP 155	115	04/09→07/16					
1.6 VTI 120	88	07/10→06/15					
1.8 i 16V	92	02/08→10/10					
2.0 16V	105	04/08→12/12					
2.0 16V BioFlex	103	02/08→06/10					
2.0 HDi	100	02/08→06/14					
2.0 HDi 140	103	04/09→06/15					
2.0 HDi 150 / BlueHDi 150	110	04/09→05/17					
2.0 HDi 165	120	04/09→07/16					
2.0 i 16V	103	02/08→10/14					
2.2 HDi	125	02/08→12/11					
2.2 HDi 165	120	02/08→08/09					
2.2 HDi 200	150	07/10→06/15					
2.7 HDi	150	02/08→10/09					
3.0 HDi 240	177	04/09→10/14					
3.0 V6	155	02/08→12/10					
2.0 HDi 180	133	03/15→05/17				24.2123-3131.3 011123	ATE Ø 23,8
CITROËN - C6 (TD_) 09/05→12/12							
 Bremskraftverstärker							
2.2 HDi	120 - 125	06/06→12/12		für Linkslenker; →Orga 11192		03.7860-3402.4 300217	ATE Ø 10" pneumatisch
				Orga 12047→; für Linkslenker		03.7860-8002.4 300258	ATE Ø 10" pneumatisch
2.7 HDi	150	09/05→12/11		→Orga 11073; für Linkslenker		03.7860-3402.4 300217	ATE Ø 10" pneumatisch
3.0 HDi	155	06/09→12/10		für Linkslenker		03.7860-8002.4 300258	ATE Ø 10" pneumatisch
3.0 HDi	177	04/09→12/12		07/09→; für Linkslenker		03.7860-8002.4 300258	ATE Ø 10" pneumatisch
3.0 V6	155	09/05→12/12		für Linkslenker; →Orga 11192		03.7860-3402.4 300217	ATE Ø 10" pneumatisch
 Hauptbremszylinder							
2.2 HDi	120 - 125	06/06→12/12		Orga 12348→		24.2123-3131.3 011123	ATE Ø 23,8
2.7 HDi	150	09/05→12/11					
3.0 HDi	155 - 177	04/09→12/12					
3.0 V6	155	09/05→12/12					
CITROËN - C8 (EA_, EB_) 06/02→							
 Bremskraftverstärker							
2.0 16V	103	09/05→		→Orga 10919; für Linkslenker		03.7860-2002.4 300216	ATE Ø 10" pneumatisch
2.0 HDi 135	100	03/06→		Orga 10920→; für Linkslenker; → 07/14		03.7860-4432.4 300313	ATE Ø 10" pneumatisch
2.0 HDi	79 - 81	07/02→		Orga 10528→; für Linkslenker; → 07/14		03.7860-2002.4 300216	ATE Ø 10" pneumatisch
2.2 HDi	94	07/02→					
2.0 HDi	88	07/06→		02/07→; für Linkslenker; → 07/14		03.7860-4432.4 300313	ATE Ø 10" pneumatisch
 Hauptbremszylinder							
2.0 16V	103	09/05→		→ 07/14		03.2122-2163.3 010800	ATE Ø 22,2
2.0 HDi 135	100	03/06→					
2.0 HDi	79 - 81	07/02→		Orga 10528→; → 07/14		03.2122-2163.3 010800	ATE Ø 22,2
2.2 HDi	94	07/02→					
2.0 HDi	88	07/06→		02/07→ 07/14		03.2122-2163.3 010800	ATE Ø 22,2
→							

	kw					! #		
CITROËN - C8 (EA_, EB_) 06/02→								
 Hauptbremszylinder								
2.0 HDi 165	120	03/06→			→ 07/14		03.2123-3421.3 010933	ATE Ø 23,8
2.2 HDi	120	06/07→						
2.2 HDi	125	06/06→12/12					03.2123-3421.3 010933	ATE Ø 23,8
CITROËN - C8 Van (EA_, EB_) 06/02→								
 Bremskraftverstärker								
2.0	103	06/04→12/11			→Orga 10919; für Linkslenker		03.7860-2002.4 300216	ATE Ø 10" pneumatisch
					Orga 10920→; für Linkslenker		03.7860-4432.4 300313	ATE Ø 10" pneumatisch
HDi	94	11/03→07/06			Orga 10528→; für Linkslenker		03.7860-2002.4 300216	ATE Ø 10" pneumatisch
HDi 110	81	11/03→12/09						
 Hauptbremszylinder								
2.0	103	06/04→12/11					03.2122-2163.3 010800	ATE Ø 22,2
HDi	94	11/03→07/06			Orga 10528→		03.2122-2163.3 010800	ATE Ø 22,2
HDi 110	81	11/03→12/09						
CITROËN - C15 Kasten/Großraumlimousine (VD_) 10/84→10/06								
 Bremskraftregler								
1.8 D	44	07/86→12/00					24.6512-1507.3 320023	lastabhängig 3x
1.9 D	44 - 51	01/00→12/05						
CITROËN - C15 Kombi 04/87→08/00								
 Bremskraftregler								
1.8 D	44	04/87→08/00					24.6512-1507.3 320023	lastabhängig 3x
CITROËN - C15 Pritsche/Fahrgestell (VDPD) 11/92→10/02								
 Bremskraftregler								
1.8 D	44	11/92→05/00					24.6512-1507.3 320023	lastabhängig 3x
1.9 D	51	09/00→10/02						
CITROËN - C-ELYSEE (DD_) 11/12→								
 Hauptbremszylinder								
1.2 PureTech 82	61	02/18→			+ ESP; Schaltgetriebe		24.4122-1703.3 010843	TRW Ø 22,2
1.2 VTi 82	60	12/14→			+ ABS / - ESP; Schaltgetriebe		24.4122-1704.3 010847	TRW Ø 22,2
					+ ESP; Automatikgetriebe		24.4122-1726.3 011096	Ø 22,2 ohne Bremsflüssigkeitsbehälter
					+ ESP; Schaltgetriebe; für Fahrzeuge mit Vakuumpumpe		24.4122-1726.3 011096	Ø 22,2 ohne Bremsflüssigkeitsbehälter
1.2 VTi 72	53	11/12→01/17			+ ESP; Orga 13342→; Schaltgetriebe		24.4122-1703.3 010843	TRW Ø 22,2
					+ ABS / - ESP; Schaltgetriebe; Orga 13342→		24.4122-1704.3 010847	TRW Ø 22,2
					+ ESP; Automatikgetriebe; Orga 14021→		24.4122-1726.3 011096	Ø 22,2 ohne Bremsflüssigkeitsbehälter
					+ ESP; →Orga 13341		24.4122-1726.3 011096	Ø 22,2 ohne Bremsflüssigkeitsbehälter
1.5 BlueHDi 100	75	05/18→			+ ESP; Schaltgetriebe		24.4122-1703.3 010843	TRW Ø 22,2
					- ESP; Schaltgetriebe		24.4122-1704.3 010847	TRW Ø 22,2
					+ ESP; Automatikgetriebe		24.4122-1726.3 011096	Ø 22,2 ohne Bremsflüssigkeitsbehälter
1.6 BlueHDi 100	73	11/14→12/16			+ ESP; Schaltgetriebe		24.4122-1703.3 010843	TRW Ø 22,2
					+ ABS / - ESP; Schaltgetriebe		24.4122-1704.3 010847	TRW Ø 22,2
					+ ESP; Automatikgetriebe		24.4122-1726.3 011096	Ø 22,2 ohne Bremsflüssigkeitsbehälter
1.6 HDi 92	68	11/12→			+ ESP		24.4122-1703.3 010843	TRW Ø 22,2
					+ ABS / - ESP; Orga 13342→		24.4122-1704.3 010847	TRW Ø 22,2
1.6 VTi 115	85	11/12→			+ ESP; Orga 13342→; Schaltgetriebe		24.4122-1703.3 010843	TRW Ø 22,2
					+ ABS / - ESP; Schaltgetriebe; Orga 13342→		24.4122-1704.3 010847	TRW Ø 22,2
					+ ESP; Schaltgetriebe; →Orga 13341		24.4122-1726.3 011096	Ø 22,2 ohne Bremsflüssigkeitsbehälter
					+ ESP; Automatikgetriebe; Orga 13342→		24.4122-1726.3 011096	Ø 22,2 ohne Bremsflüssigkeitsbehälter

	kw			 	! #		
CITROËN - DS3 (SA_) 11/09→12/16							
 Hauptbremszylinder							
1.2 THP 110 1.6 BlueHDi 100 1.6 BlueHDi 120 1.6 BlueHDi 75 1.6 HDi 115 1.6 THP 165	81 73 88 55 85 121	10/14→03/15 07/14→07/15 10/13→07/15 03/15→07/15 10/13→07/15 10/14→06/15				24.4123-1734.3 011130	Ø 23,8 ohne Bremsflüssigkeitsbehälter
1.2 VTi 82	60	01/13→03/15				24.4122-1726.3 011096	Ø 22,2 ohne Bremsflüssigkeitsbehälter
1.4 HDi 70 1.6 HDi 110 1.6 HDi 90 1.6 Racing	50 82 68 149 -	04/10→07/15 11/09→07/15 11/09→07/15 02/11→07/15		12999→ 13341 Orga 13342→		24.4123-1704.3 010828 24.4123-1734.3 011130	TRW Ø 23,8 Ø 23,8 ohne Bremsflüssigkeitsbehälter
1.6 THP 155 1.6 VTi 120	152 115 88	04/10→07/15 04/10→07/15		→Orga 12998		24.4123-1734.3 011130	Ø 23,8 ohne Bremsflüssigkeitsbehälter
1.4 VTi 95 1.4 VTi 95 LPG	70 70	04/10→07/15 08/12→07/15		12999→ 13341 12775→ 12998		24.4122-1703.3 010843 24.4122-1726.3 011096	TRW Ø 22,2 Ø 22,2 ohne Bremsflüssigkeitsbehälter
				Orga 13342→		24.4122-1726.3 011096 24.4123-1734.3 011130	Ø 22,2 ohne Bremsflüssigkeitsbehälter Ø 23,8 ohne Bremsflüssigkeitsbehälter
				→Orga 12774		24.4123-1734.3 011130	Ø 23,8 ohne Bremsflüssigkeitsbehälter
1.4 VTi 98	72	11/09→07/15		12999→ 13341 12775→ 12998		24.4122-1703.3 010843 24.4122-1726.3 011096	TRW Ø 22,2 Ø 22,2 ohne Bremsflüssigkeitsbehälter
				Orga 13342→		24.4122-1726.3 011096 24.4123-1734.3 011130	Ø 22,2 ohne Bremsflüssigkeitsbehälter Ø 23,8 ohne Bremsflüssigkeitsbehälter
				04/10→; →Orga 12774		24.4123-1734.3 011130	Ø 23,8 ohne Bremsflüssigkeitsbehälter
1.6 HDi 115	84	08/12→07/15		→Orga 13341 Orga 13342→		24.4123-1704.3 010828 24.4123-1734.3 011130	TRW Ø 23,8 Ø 23,8 ohne Bremsflüssigkeitsbehälter
1.6 THP 150	110	01/10→07/15		12999→ 13341 Orga 13342→		24.4123-1704.3 010828 24.4123-1734.3 011130	TRW Ø 23,8 Ø 23,8 ohne Bremsflüssigkeitsbehälter
				04/10→; →Orga 12998		24.4123-1734.3 011130	Ø 23,8 ohne Bremsflüssigkeitsbehälter
1.6 THP160	120	01/12→07/15		10/14→		24.4123-1734.3 011130	Ø 23,8 ohne Bremsflüssigkeitsbehälter
CITROËN - DS3 Cabriolet 01/13→07/15							
 Hauptbremszylinder							
1.2 THP 110 1.6 BlueHDi 100	81 73 - 75	10/14→07/15 07/14→07/15				24.4123-1704.3 010828 24.4123-1734.3 011130	TRW Ø 23,8 Ø 23,8 ohne Bremsflüssigkeitsbehälter
1.6 BlueHDi 115 1.6 BlueHDi 120 1.6 Racing	85 88 149 -	10/13→07/15 07/14→07/15 03/14→07/15					
1.6 THP 165	120 - 121	10/14→07/15					
1.2 VTi 82	60	01/13→07/15		03/13→		24.4122-1726.3 011096	Ø 22,2 ohne Bremsflüssigkeitsbehälter
1.6 HDi 90 1.6 THP 150 1.6 THP 155 1.6 VTi 120	68 110 115 88	01/13→07/15 01/13→07/15 01/13→07/15 01/13→07/15		03/13→		24.4123-1704.3 010828 24.4123-1734.3 011130	TRW Ø 23,8 Ø 23,8 ohne Bremsflüssigkeitsbehälter
CITROËN - DS4 (NX_) 03/11→07/15							
 Hauptbremszylinder							
1.2 THP 130 1.6 BlueHDi 120 1.6 HDi 110 1.6 HDi 115 1.6 HDi 90 1.6 THP 150 1.6 THP 155 1.6 THP 160 1.6 VTi 120 2.0 BlueHDi 150	96 88 82 84 68 110 115 120 88 110	07/14→07/15 07/14→07/15 04/11→07/15 08/12→07/15 05/11→07/15 04/11→07/15 04/11→07/15 04/12→07/15 04/11→07/15 07/14→07/15		+ ESP - ESP		24.4123-1726.3 011099 24.4123-1739.3 011150	Ø 23,8 ohne Bremsflüssigkeitsbehälter BOS Ø 23,8 ohne Bremsflüssigkeitsbehälter

	kw					! #		
CITROËN - DS4 (NX_) 03/11→07/15								
 Hauptbremszylinder								
2.0 HDi / BlueHDi 135 2.0 HDi 165	100 120	09/11→07/15 04/11→07/15		+ ESP		24.4123-1726.3	011099	Ø 23,8 ohne Bremsflüssigkeitsbehälter
				- ESP		24.4123-1739.3	011150	BOS Ø 23,8 ohne Bremsflüssigkeitsbehälter
1.6 BlueHDi 115	85	07/14→07/15		08/14→; + ESP		24.4123-1726.3	011099	Ø 23,8 ohne Bremsflüssigkeitsbehälter
				08/14→; - ESP		24.4123-1739.3	011150	BOS Ø 23,8 ohne Bremsflüssigkeitsbehälter
1.6 THP 165	121	01/12→07/15		04/12→; + ESP		24.4123-1726.3	011099	Ø 23,8 ohne Bremsflüssigkeitsbehälter
				04/12→; - ESP		24.4123-1739.3	011150	BOS Ø 23,8 ohne Bremsflüssigkeitsbehälter
2.0 BlueHDi 180	133	07/14→07/15		10/14→; + ESP		24.4123-1726.3	011099	Ø 23,8 ohne Bremsflüssigkeitsbehälter
				10/14→; - ESP		24.4123-1739.3	011150	BOS Ø 23,8 ohne Bremsflüssigkeitsbehälter
CITROËN - DS5 09/11→12/16								
 Bremskraftverstärker								
1.6 BlueHDi 120 1.6 HDi 1.6 HDi 110 1.6 THP 150 1.6 THP 155 1.6 THP 165 1.6 THP 165 Hybrid 1.6 THP 200 2.0 BlueHDi 150 2.0 BlueHDi 180 2.0 HDi 135 2.0 HDi 165	88 85 82 110 115 121 121 147 110 133 100 120	07/14→07/15 11/13→07/15 11/11→07/15 11/11→07/15 11/11→07/15 01/12→07/15 06/12→07/15 11/11→07/15 07/14→07/15 08/13→07/15 11/11→07/15 11/11→07/15		für Fahrzeuge mit Start-Stopp-Funktion		03.7860-3734.4	300317	ATE Ø 10" pneumatisch
1.6 HDi 115	84	06/12→07/15		08/12→; für Fahrzeuge mit Start-Stopp-Funktion		03.7860-3734.4	300317	ATE Ø 10" pneumatisch
2.0 HDi 200 Hybrid4 All-wheel Drive	147	12/11→07/15				03.7860-3734.4	300317	ATE Ø 10" pneumatisch
 Hauptbremszylinder								
1.6 BlueHDi 120 1.6 HDi 1.6 HDi 110 1.6 THP 150 1.6 THP 155 1.6 THP 165 1.6 THP 165 Hybrid 1.6 THP 200 2.0 BlueHDi 150 2.0 BlueHDi 180 2.0 HDi 135 2.0 HDi 165 2.0 HDi 200 Hybrid4 All-wheel Drive	88 85 82 110 115 121 121 147 110 133 100 120 147	07/14→07/15 11/13→07/15 11/11→07/15 11/11→07/15 11/11→07/15 01/12→07/15 06/12→07/15 11/11→07/15 07/14→07/15 08/13→07/15 11/11→07/15 11/11→07/15 12/11→07/15		82 mm Radnabendurchmesser [mm]		03.4153-0173.3	010815	ATE Ø 23,8
				83 mm Radnabendurchmesser [mm]		24.4155-1236.3	011049	ATE Ø 25,4 ohne Bremsflüssigkeitsbehälter
1.6 HDi 115	84	06/12→07/15		08/12→; 82 mm Radnabendurchmesser [mm]		03.4153-0173.3	010815	ATE Ø 23,8
				08/12→; 83 mm Radnabendurchmesser [mm]		24.4155-1236.3	011049	ATE Ø 25,4 ohne Bremsflüssigkeitsbehälter
CITROËN - EVASION Großraumlimousine (22, U6) 03/94→07/02								
 Hauptbremszylinder								
1.8	73	05/97→07/02		→Orga 08206; - ABS		24.2122-1703.3	010422	Ø 22,2
				→Orga 08206; + ABS		24.2122-1708.3	010437	Ø 22,2
				Orga 08207→; - ABS		24.2122-1741.3	010695	Ø 22,2
1.9 TD	66	11/94→07/02		02/95→; →Orga 08206; - ABS		24.2123-1707.3	010492	Ø 23,8
				Orga 08207→; + ABS		24.2123-1733.3	010657	BOS Ø 23,8
				Orga 08207→; - ABS		24.2123-1738.3	010658	Ø 23,8
2.0 2.0 16V 2.0 Turbo C.T.	89 100 108	06/94→07/02 05/00→07/02 06/94→07/02		→Orga 08206; - ABS		24.2123-1707.3	010492	Ø 23,8
2.1 TD	80	05/96→07/02		Orga 08207→; + ABS		24.2123-1733.3	010657	BOS Ø 23,8
2.0 16V	97	05/98→04/00		Orga 08207→; - ABS		24.2123-1738.3	010658	Ø 23,8
				12/98→; →Orga 08206; - ABS		24.2123-1707.3	010492	Ø 23,8
				Orga 08207→; + ABS		24.2123-1733.3	010657	BOS Ø 23,8
				Orga 08207→; - ABS		24.2123-1738.3	010658	Ø 23,8
2.0 HDI	80	08/99→07/02		+ ABS		24.2123-1733.3	010657	BOS Ø 23,8
2.0 HDi 16V	81 80	09/99→07/02		- ABS		24.2123-1738.3	010658	Ø 23,8

CITROËN - GRAND C4 SPACETOURER (3A_, 3E_) 04/18→

Hauptbremszylinder

1.2 PureTech 130	96	04/18→			24.4155-1311.3 011053	ATE Ø 25,4 ohne Bremsflüssigkeitsbehälter
1.5 BlueHDi 130	96	05/18→				
1.6 BlueHDi 100	73	04/18→04/19				
1.6 BlueHDi 120	88	04/18→08/18				
1.6 HDi 115	85	04/18→				
1.6 PureTech 180	133	04/18→				
1.6 THP 165	110 - 121	04/18→				
2.0 BlueHDi 150	110	04/18→				
2.0 BlueHDi 160	120	04/18→				

CITROËN - GRAND C4 SPACETOURER Van (3A_, 3E_) 04/18→













Hauptbremszylinder









BlueHDi 130	96	05/19→			24.4155-1311.3 011053	ATE Ø 25,4 ohne Bremsflüssigkeitsbehälter
BlueHDi 160	120	05/19→				
PureTech 130	96	05/19→				













CITROËN - JUMPER I Bus (230P) 02/94→04/02

Hauptbremszylinder

1.9 D	51	01/99→04/02	→ S 15064995; Nutzlast [kg]: 1000; für Linkslenker; - ABS	24.2122-1715.3 010481	Ø 22,2
			S 15064996→ S 16206233; Nutzlast [kg]: 1000; + ABS	24.2125-1702.3 010482	Ø 25,4
			S 15064996→ S 16205754; Nutzlast [kg]: 1000; für Linkslenker; - ABS	24.2125-1703.3 010483	Ø 25,4
			S 16206234→; → 03/02; Nutzlast [kg]: 1000; + ABS	24.2125-1726.3 010718	Ø 25,4
1.9 TD 1.9 TD 4x4	66 - 68 68	02/94→04/02 08/96→04/02	→ S 15064995; Nutzlast ab [kg] 1000 Nutzlast bis [kg] 1400; für Linkslenker; - ABS	24.2122-1715.3 010481	Ø 22,2
			S 15064996→ S 16206233; Nutzlast ab [kg] 1000 Nutzlast bis [kg] 1400; + ABS	24.2125-1702.3 010482	Ø 25,4
			S 15064996→ S 16205754; Nutzlast ab [kg] 1000 Nutzlast bis [kg] 1400; für Linkslenker; - ABS	24.2125-1703.3 010483	Ø 25,4
			S 16206234→; → 03/02; Nutzlast ab [kg] 1000 Nutzlast bis [kg] 1400; + ABS	24.2125-1726.3 010718	Ø 25,4
2.0	80	02/94→04/02	→ S 15064995; Nutzlast [kg]: 1000; für Linkslenker; - ABS	24.2122-1715.3 010481	Ø 22,2
			S 15064996→ S 16206233; Nutzlast ab [kg] 1000 Nutzlast bis [kg] 1400; + ABS	24.2125-1702.3 010482	Ø 25,4
			→ S 16194399; Nutzlast [kg]: 1800; + ABS	24.2125-1702.3 010482	Ø 25,4
			S 15064996→ S 16205754; Nutzlast ab [kg] 1000 Nutzlast bis [kg] 1400; für Linkslenker; - ABS	24.2125-1703.3 010483	Ø 25,4
			→ S 16205754; Nutzlast [kg]: 1800; für Linkslenker; - ABS	24.2125-1703.3 010483	Ø 25,4
			S 16194400→; → 03/02; Nutzlast [kg]: 1800; + ABS	24.2125-1726.3 010718	Ø 25,4
			S 16206234→; → 03/02; Nutzlast ab [kg] 1000 Nutzlast bis [kg] 1400; + ABS	24.2125-1726.3 010718	Ø 25,4
2.0 4x4	80	08/96→04/02	S 15064996→ S 16206233; Nutzlast ab [kg] 1000 Nutzlast bis [kg] 1400; + ABS	24.2125-1702.3 010482	Ø 25,4
			S 15064996→ S 16205754; Nutzlast ab [kg] 1000 Nutzlast bis [kg] 1400; für Linkslenker; - ABS	24.2125-1703.3 010483	Ø 25,4
			S 16206234→; → 03/02; Nutzlast ab [kg] 1000 Nutzlast bis [kg] 1400; + ABS	24.2125-1726.3 010718	Ø 25,4
2.5 D 2.5 TD	63 76	08/94→04/02 08/94→04/02	→ S 15064995; Nutzlast [kg]: 1400; für Linkslenker; - ABS	24.2122-1715.3 010481	Ø 22,2
			→ S 16194399; Nutzlast [kg]: 1800; + ABS	24.2125-1702.3 010482	Ø 25,4
			S 15064996→ S 16206233; Nutzlast [kg]: 1400; + ABS	24.2125-1702.3 010482	Ø 25,4
			→ S 16205754; Nutzlast [kg]: 1800; für Linkslenker; - ABS	24.2125-1703.3 010483	Ø 25,4
			S 15064996→ S 16205754; Nutzlast [kg]: 1400; für Linkslenker; - ABS	24.2125-1703.3 010483	Ø 25,4
			S 16206234→; → 03/02; Nutzlast [kg]: 1400; + ABS	24.2125-1726.3 010718	Ø 25,4
			S 16194400→; → 03/02; Nutzlast [kg]: 1800; + ABS	24.2125-1726.3 010718	Ø 25,4
2.5 TDi	79	12/96→11/00	→ S 16194399; Nutzlast [kg]: 1800; + ABS	24.2125-1702.3 010482	Ø 25,4
→					

	kw					! #		
CITROËN - JUMPER I Bus (230P) 02/94→04/02								
 Hauptbremszylinder								
2.5 TDi	79	12/96→11/00		S 15064996→ S 16206233; Nutzlast [kg]: 1400; + ABS		24.2125-1702.3	010482	Ø 25,4
				→ S 16205754; Nutzlast ab [kg] 1400 Nutzlast bis [kg] 1800; für Linkslenker; - ABS		24.2125-1703.3	010483	Ø 25,4
				S 16206234→; Nutzlast [kg]: 1400; + ABS		24.2125-1726.3	010718	Ø 25,4
				S 16194400→; Nutzlast [kg]: 1800; + ABS		24.2125-1726.3	010718	Ø 25,4
2.5 TDi 4x4 2.8 HDi 4x4	79 94	12/96→11/00 09/00→04/02		→ S 16205754; Nutzlast ab [kg] 1400 Nutzlast bis [kg] 1800; für Linkslenker; - ABS		24.2125-1703.3	010483	Ø 25,4
2.8 D	64	01/99→02/02		→ S 15064995; Nutzlast [kg]: 1400; für Linkslenker; - ABS		24.2122-1715.3	010481	Ø 22,2
				→ S 16194399; Nutzlast [kg]: 1800		24.2125-1702.3	010482	Ø 25,4
				S 15064996→ S 16206253; Nutzlast [kg]: 1400; + ABS		24.2125-1702.3	010482	Ø 25,4
				S 15064996→ S 16205754; Nutzlast [kg]: 1400; für Linkslenker; - ABS		24.2125-1703.3	010483	Ø 25,4
				→ S 16205352; Nutzlast [kg]: 1800; für Linkslenker; - ABS		24.2125-1703.3	010483	Ø 25,4
				S 16194400→; Nutzlast [kg]: 1800; + ABS		24.2125-1726.3	010718	Ø 25,4
				S 16206254→; Nutzlast [kg]: 1400; + ABS		24.2125-1726.3	010718	Ø 25,4
2.8 HDi	94	09/00→04/02		→ S 16206233; Nutzlast [kg]: 1400; + ABS		24.2125-1702.3	010482	Ø 25,4
				→ S 16194399; Nutzlast [kg]: 1800; + ABS		24.2125-1702.3	010482	Ø 25,4
				→ S 16205754; Nutzlast ab [kg] 1400 Nutzlast bis [kg] 1800; für Linkslenker; - ABS		24.2125-1703.3	010483	Ø 25,4
				S 16206234→; → 03/02; Nutzlast [kg]: 1400; + ABS		24.2125-1726.3	010718	Ø 25,4
				S 16194400→; → 03/02; Nutzlast [kg]: 1800; + ABS		24.2125-1726.3	010718	Ø 25,4
 Bremskraftregler								
1.9 D	51	01/99→04/02		→ S 16206244; Nutzlast [kg]: 1000; - ABS		24.6512-1701.3	320153	lastabhängig 2x
1.9 TD	66	02/94→04/02		→ S 16206244; Nutzlast ab [kg] 1000 Nutzlast bis [kg] 1400; - ABS		24.6512-1701.3	320153	lastabhängig 2x
1.9 TD 4x4	68	08/96→04/02						
2.0	80	02/94→04/02		→ S 16206244; Nutzlast ab [kg] 1000 Nutzlast bis [kg] 1800; - ABS		24.6512-1701.3	320153	lastabhängig 2x
2.0 4x4	80	08/96→04/02						
2.5 D	63	08/94→04/02		→ S 16206244; Nutzlast ab [kg] 1400 Nutzlast bis [kg] 1800; - ABS		24.6512-1701.3	320153	lastabhängig 2x
2.5 D 4x4	63	08/96→04/02						
2.5 TD	76	08/94→04/02						
2.5 TD 4x4	76	08/96→04/02						
2.8 D	64	01/99→02/02						
2.8 HDi	94	09/00→04/02						
2.8 HDi 4x4	94	09/00→04/02						
2.5 TDi	79	12/96→11/00		Nutzlast ab [kg] 1400 Nutzlast bis [kg] 1800; - ABS		24.6512-1701.3	320153	lastabhängig 2x
2.5 TDi 4x4	79	12/96→11/00						
CITROËN - JUMPER I Bus (244, Z_) 04/02→								
 Hauptbremszylinder								
2.0	81	04/02→06/06		→ 03/06; Nutzlast ab [kg] 1000 Nutzlast bis [kg] 1800; + ABS		24.2125-1726.3	010718	Ø 25,4
2.0 HDi	62	04/02→06/06						
2.2 HDi	74	04/02→06/06						
2.8 HDi	94	04/02→06/06						
2.0 bivalent	81	02/03→06/06		→ S 15064995; Nutzlast [kg]: 1000; für Linkslenker; - ABS		24.2122-1715.3	010481	Ø 22,2
2.8 HDi All-wheel Drive	94	04/02→06/06		→ 03/06; + ABS		24.2125-1726.3	010718	Ø 25,4
 Bremskraftregler								
2.8 HDi All-wheel Drive	94	04/02→06/06		→ 03/06; Nutzlast ab [kg] 1000 Nutzlast bis [kg] 1800; - ABS		24.6512-1701.3	320153	lastabhängig 2x
CITROËN - JUMPER I Kasten (230L) 02/94→08/02								
 Hauptbremszylinder								
1.9 D	50 51	02/94→04/02		→ S 15064995; Nutzlast [kg]: 1000; für Linkslenker; - ABS		24.2122-1715.3	010481	Ø 22,2
→								

	kw			 	! #		
CITROËN - JUMPER I Kasten (230L) 02/94→08/02							
 Hauptbremszylinder							
1.9 D	50 - 51	02/94→04/02		S 15064996→ S 16206233; Nutzlast [kg]: 1000; + ABS	24.2125-1702.3	010482	Ø 25,4
				S 15064996→ S 16205754; Nutzlast [kg]: 1000; für Linkslenker; - ABS	24.2125-1703.3	010483	Ø 25,4
				S 16206234→; → 03/02; Nutzlast [kg]: 1000; + ABS	24.2125-1726.3	010718	Ø 25,4
1.9 TD	66 - 68	03/94→04/02		→ S 15064995; Nutzlast ab [kg] 1000 Nutzlast bis [kg] 1400; für Linkslenker; - ABS	24.2122-1715.3	010481	Ø 22,2
				S 15064996→ S 16206233; Nutzlast ab [kg] 1000 Nutzlast bis [kg] 1400; + ABS	24.2125-1702.3	010482	Ø 25,4
				S 15064996→ S 16205754; Nutzlast ab [kg] 1000 Nutzlast bis [kg] 1400; für Linkslenker; - ABS	24.2125-1703.3	010483	Ø 25,4
				S 16206234→; → 03/02; Nutzlast ab [kg] 1000 Nutzlast bis [kg] 1400; + ABS	24.2125-1726.3	010718	Ø 25,4
2.0	80	03/94→04/02		→ S 15064995; Nutzlast ab [kg] 1000 Nutzlast bis [kg] 1400; für Linkslenker; - ABS	24.2122-1715.3	010481	Ø 22,2
				S 15064996→ S 16206233; Nutzlast ab [kg] 1000 Nutzlast bis [kg] 1400; + ABS	24.2125-1702.3	010482	Ø 25,4
				→ S 16194399; Nutzlast [kg]: 1800; + ABS	24.2125-1702.3	010482	Ø 25,4
				→ S 16205754; Nutzlast [kg]: 1800; für Linkslenker; - ABS	24.2125-1703.3	010483	Ø 25,4
				S 15064996→ S 16205754; Nutzlast ab [kg] 1000 Nutzlast bis [kg] 1400; für Linkslenker; - ABS	24.2125-1703.3	010483	Ø 25,4
				S 16206234→; → 03/02; Nutzlast ab [kg] 1000 Nutzlast bis [kg] 1400; + ABS	24.2125-1726.3	010718	Ø 25,4
2.0 4x4	80	10/96→01/02		→ S 15064995; Nutzlast ab [kg] 1000 Nutzlast bis [kg] 1400; für Linkslenker; - ABS	24.2122-1715.3	010481	Ø 22,2
				S 15064996→ S 16206233; Nutzlast ab [kg] 1000 Nutzlast bis [kg] 1400; + ABS	24.2125-1702.3	010482	Ø 25,4
				→ S 16194399; Nutzlast [kg]: 1800; + ABS	24.2125-1702.3	010482	Ø 25,4
				→ S 16205754; Nutzlast [kg]: 1800; für Linkslenker; - ABS	24.2125-1703.3	010483	Ø 25,4
				S 15064996→ S 16205754; Nutzlast ab [kg] 1000 Nutzlast bis [kg] 1400; für Linkslenker; - ABS	24.2125-1703.3	010483	Ø 25,4
				S 16206234→; Nutzlast ab [kg] 1000 Nutzlast bis [kg] 1400; + ABS	24.2125-1726.3	010718	Ø 25,4
				S 16194400→; Nutzlast [kg]: 1800; + ABS	24.2125-1726.3	010718	Ø 25,4
2.0 HDI	62	11/01→04/02		→ 03/02; Nutzlast ab [kg] 1000 Nutzlast bis [kg] 1800; + ABS	24.2125-1726.3	010718	Ø 25,4
2.5 D 2.5 D 4x4 2.5 TD	63	03/94→04/02		→ S 15064995; Nutzlast [kg]: 1400; für Linkslenker; - ABS	24.2122-1715.3	010481	Ø 22,2
	63	03/00→04/02					
	76	03/94→04/02		→ S 16194399; Nutzlast [kg]: 1800; + ABS	24.2125-1702.3	010482	Ø 25,4
				S 15064996→ S 16206233; Nutzlast [kg]: 1400; + ABS	24.2125-1702.3	010482	Ø 25,4
				→ S 16205754; Nutzlast [kg]: 1800; für Linkslenker; - ABS	24.2125-1703.3	010483	Ø 25,4
				S 15064996→ S 16205754; Nutzlast [kg]: 1400; für Linkslenker; - ABS	24.2125-1703.3	010483	Ø 25,4
				S 16206234→; → 03/02; Nutzlast [kg]: 1400; + ABS	24.2125-1726.3	010718	Ø 25,4
			S 16194400→; → 03/02; Nutzlast [kg]: 1800; + ABS	24.2125-1726.3	010718	Ø 25,4	
2.5 TDi 2.5 TDi 4x4	79	12/96→11/00		→ S 16194399; Nutzlast [kg]: 1800; + ABS	24.2125-1702.3	010482	Ø 25,4
	79	03/00→11/00					
				S 15064996→ S 16206233; Nutzlast [kg]: 1400; + ABS	24.2125-1702.3	010482	Ø 25,4
				→ S 16205754; Nutzlast ab [kg] 1400 Nutzlast bis [kg] 1800; für Linkslenker; - ABS	24.2125-1703.3	010483	Ø 25,4
				S 16194400→; Nutzlast [kg]: 1800; + ABS	24.2125-1726.3	010718	Ø 25,4
			S 16206234→; Nutzlast [kg]: 1400; + ABS	24.2125-1726.3	010718	Ø 25,4	
→							

	kw					! #		
CITROËN - JUMPER I Kasten (230L) 02/94→08/02								
 Hauptbremszylinder								
2.8 HDi 2.8 HDi 4x4	94 94	09/00→04/02 09/00→04/02		→ S 16194399; Nutzlast [kg]: 1800; + ABS			24.2125-1702.3 010482	Ø 25,4
				S 15064996→ S 16206233; Nutzlast [kg]: 1400; + ABS			24.2125-1702.3 010482	Ø 25,4
				→ S 16205754; Nutzlast ab [kg] 1400 Nutzlast bis [kg] 1800; für Linkslenker; - ABS			24.2125-1703.3 010483	Ø 25,4
				S 16206234→; → 03/02; Nutzlast [kg]: 1400; + ABS			24.2125-1726.3 010718	Ø 25,4
				S 16194400→; → 03/02; Nutzlast [kg]: 1800; + ABS			24.2125-1726.3 010718	Ø 25,4
 Bremskraftregler								
1.9 D	50 - 51	02/94→04/02		→ S 16206244; Nutzlast [kg]: 1000; - ABS			24.6512-1701.3 320153	lastabhängig 2x
1.9 TD	66 - 68	03/94→04/02		→ S 16206244; Nutzlast ab [kg] 1000 Nutzlast bis [kg] 1400; - ABS			24.6512-1701.3 320153	lastabhängig 2x
2.0 2.0 4x4	80 80	03/94→04/02 10/96→01/02		→ S 16206244; Nutzlast ab [kg] 1000 Nutzlast bis [kg] 1800; - ABS			24.6512-1701.3 320153	lastabhängig 2x
2.5 D 2.5 D 4x4 2.5 TD 2.5 TDi 2.5 TDi 4x4 2.8 HDi 2.8 HDi 4x4	63 63 76 79 79 94 94	03/94→04/02 03/00→04/02 03/94→04/02 12/96→11/00 03/00→11/00 09/00→04/02 09/00→04/02		→ S 16206244; Nutzlast ab [kg] 1400 Nutzlast bis [kg] 1800; - ABS			24.6512-1701.3 320153	lastabhängig 2x
CITROËN - JUMPER I Kasten (244) 04/02→								
 Hauptbremszylinder								
2.0 2.0 bivalent 2.0 HDi 2.2 HDi 2.8 HDi	81 81 62 74 94 - 107	04/02→06/06 02/03→06/06 04/02→06/06 04/02→06/06 04/02→06/06		→ 03/06; Nutzlast ab [kg] 1000 Nutzlast bis [kg] 1800; + ABS			24.2125-1726.3 010718	Ø 25,4
2.8 HDi 4x4	94	04/02→06/06		→ 03/06; + ABS			24.2125-1726.3 010718	Ø 25,4
 Bremskraftregler								
2.8 HDi 4x4	94	04/02→06/06		→ 03/06; Nutzlast ab [kg] 1000 Nutzlast bis [kg] 1800; - ABS			24.6512-1701.3 320153	lastabhängig 2x
CITROËN - JUMPER I Pritsche/Fahrgestell (230) 03/94→04/02								
 Hauptbremszylinder								
1.9 TD	66 - 68	03/94→04/02		→ S 15064995; Nutzlast ab [kg] 1000 Nutzlast bis [kg] 1400; - ABS; für Linkslenker			24.2122-1715.3 010481	Ø 22,2
				S 15064996→ S 16206233; Nutzlast ab [kg] 1000 Nutzlast bis [kg] 1400; + ABS			24.2125-1702.3 010482	Ø 25,4
				S 15064996→ S 16205754; Nutzlast ab [kg] 1000 Nutzlast bis [kg] 1400; - ABS; für Linkslenker			24.2125-1703.3 010483	Ø 25,4
				S 16206234→; → 03/02; Nutzlast ab [kg] 1000 Nutzlast bis [kg] 1400; + ABS			24.2125-1726.3 010718	Ø 25,4
2.0	80	03/94→04/02		→ S 15064995; Nutzlast ab [kg] 1000 Nutzlast bis [kg] 1400; - ABS; für Linkslenker			24.2122-1715.3 010481	Ø 22,2
				S 15064996→ S 16206233; Nutzlast ab [kg] 1000 Nutzlast bis [kg] 1400; + ABS			24.2125-1702.3 010482	Ø 25,4
				→ S 16194399; Nutzlast [kg]: 1800; + ABS			24.2125-1702.3 010482	Ø 25,4
				→ S 16205754; Nutzlast [kg]: 1800; - ABS; für Linkslenker			24.2125-1703.3 010483	Ø 25,4
				S 15064996→ S 16205754; Nutzlast ab [kg] 1000 Nutzlast bis [kg] 1400; - ABS; für Linkslenker			24.2125-1703.3 010483	Ø 25,4
				S 16206234→; → 03/02; Nutzlast ab [kg] 1000 Nutzlast bis [kg] 1400; + ABS			24.2125-1726.3 010718	Ø 25,4
				S 16194400→; → 03/02; Nutzlast [kg]: 1800; + ABS			24.2125-1726.3 010718	Ø 25,4
2.5 D 2.5 D 4x4 2.5 TD	63 63 76	03/94→04/02 03/00→04/02 03/94→04/02		→ S 15064995; Nutzlast [kg]: 1400; - ABS; für Linkslenker			24.2122-1715.3 010481	Ø 22,2
				→ S 16194399; Nutzlast [kg]: 1800; + ABS			24.2125-1702.3 010482	Ø 25,4
				S 15064996→ S 16206233; Nutzlast [kg]: 1400; + ABS			24.2125-1702.3 010482	Ø 25,4
→								



CITROËN - JUMPER I Pritsche/Fahrgestell (230) 03/94→04/02

Hauptbremszylinder

2.5 D 2.5 D 4x4 2.5 TD	63	03/94→04/02	→ S 16205754; Nutzlast [kg]: 1800; - ABS; für Linkslenker	24.2125-1703.3	010483	Ø 25,4
	63	03/00→04/02				
	76	03/94→04/02	→ S 15064996→ S 16205754; Nutzlast [kg]: 1400; - ABS; für Linkslenker	24.2125-1703.3	010483	Ø 25,4
			→ S 16194400→; → 03/02; Nutzlast [kg]: 1800; + ABS	24.2125-1726.3	010718	Ø 25,4
		→ S 16206234→; → 03/02; Nutzlast [kg]: 1400; + ABS	24.2125-1726.3	010718	Ø 25,4	
2.5 TDi 2.5 TDi 4x4 2.8 HDi	79	12/96→04/02	→ S 16206233; Nutzlast [kg]: 1400; + ABS	24.2125-1702.3	010482	Ø 25,4
	79	03/00→04/02				
	94	09/00→04/02	→ S 16194399; Nutzlast [kg]: 1800; + ABS	24.2125-1702.3	010482	Ø 25,4
			→ S 16205754; Nutzlast ab [kg] 1400 Nutzlast bis [kg] 1800; - ABS; für Linkslenker	24.2125-1703.3	010483	Ø 25,4
		→ S 16194400→; → 03/02; Nutzlast [kg]: 1800; + ABS	24.2125-1726.3	010718	Ø 25,4	
		→ S 16206234→; → 03/02; Nutzlast [kg]: 1400; + ABS	24.2125-1726.3	010718	Ø 25,4	
2.8 D	64	01/99→02/02	→ S 15064995; Nutzlast [kg]: 1400; - ABS; für Linkslenker	24.2122-1715.3	010481	Ø 22,2
			→ S 16194399; Nutzlast [kg]: 1800; + ABS	24.2125-1702.3	010482	Ø 25,4
			S 15064996→ S 16206253; Nutzlast [kg]: 1400; + ABS	24.2125-1702.3	010482	Ø 25,4
			→ S 16205352; Nutzlast [kg]: 1800; für Linkslenker; - ABS	24.2125-1703.3	010483	Ø 25,4
			S 15064996→ S 16205754; Nutzlast [kg]: 1400; - ABS; für Linkslenker	24.2125-1703.3	010483	Ø 25,4
			S 16206254→; Nutzlast [kg]: 1400; + ABS	24.2125-1726.3	010718	Ø 25,4
		S 16194400→; Nutzlast [kg]: 1800; + ABS	24.2125-1726.3	010718	Ø 25,4	

Bremskraftregler

1.9 TD	66 - 68	03/94→04/02	→ S 16206244; Nutzlast ab [kg] 1000 Nutzlast bis [kg] 1400; - ABS	24.6512-1701.3	320153	lastabhängig 2x
2.0	80	03/94→04/02	→ S 16206244; Nutzlast ab [kg] 1000 Nutzlast bis [kg] 1800; - ABS	24.6512-1701.3	320153	lastabhängig 2x
2.5 D 2.5 D 4x4 2.5 TD 2.5 TDi 2.5 TDi 4x4 2.8 D 2.8 HDi	63 63 76 79 79 64 94	03/94→04/02 03/00→04/02 03/94→04/02 12/96→04/02 03/00→04/02 01/99→02/02 09/00→04/02	→ S 16206244; Nutzlast ab [kg] 1400 Nutzlast bis [kg] 1800; - ABS	24.6512-1701.3	320153	lastabhängig 2x

CITROËN - JUMPER I Pritsche/Fahrgestell (244) 02/02→

Hauptbremszylinder

2.0 HDi 2.2 HDi 2.8 HDi	62 74 94 - 107	04/02→06/06 04/02→06/06 04/02→06/06	→ 03/06; Nutzlast ab [kg] 1000 Nutzlast bis [kg] 1800; + ABS	24.2125-1726.3	010718	Ø 25,4
2.8 HDi 4x4	94	02/02→06/06	04/02→ 03/06; + ABS	24.2125-1726.3	010718	Ø 25,4











Bremskraftregler

2.8 HDi 4x4	94	02/02→06/06	04/02→ 03/06; Nutzlast ab [kg] 1000 Nutzlast bis [kg] 1800; - ABS	24.6512-1701.3	320153	lastabhängig 2x
-------------	----	-------------	---	----------------	--------	-----------------











CITROËN - JUMPER II Bus 04/06→















Hauptbremszylinder

2.0 BlueHDi 110 2.0 BlueHDi 130 2.0 BlueHDi 160 2.2 BlueHDi 120 2.2 BlueHDi 140 2.2 BlueHDi 165	81 96 120 88 103 121	07/15→09/19 07/15→09/19 07/15→09/19 08/19→10/23 08/19→10/23 08/19→10/23	Nutzlast ab [kg] 1200 Nutzlast bis [kg] 1600; - DSC; Nutzlast-Code: 12Q / 14Q / 16Q	24.4125-1717.3	011157	BOS Ø 25,4 ohne Bremsflüssigkeitsbehälter
			Nutzlast ab [kg] 1200 Nutzlast bis [kg] 1600; + DSC; Nutzlast-Code: 12Q / 14Q / 16Q	24.4125-1718.3	011158	BOS Ø 25,4 ohne Bremsflüssigkeitsbehälter
			Nutzlast [kg]: 2000; - DSC; Nutzlast-Code: 20Q	24.4126-1704.3	011159	Ø 27 ohne Bremsflüssigkeitsbehälter
			Nutzlast [kg]: 2000; + DSC; Nutzlast-Code: 20Q	24.4126-1705.3	011160	Ø 27 ohne Bremsflüssigkeitsbehälter
2.2 HDi 100 2.2 HDi 110 2.2 HDi 120 →	74 81 88	04/06→ 07/11→12/20 04/06→12/16	Nutzlast ab [kg] 1200 Nutzlast bis [kg] 1400; + DSC; nicht für Facelift; Nutzlast-Code: 12Q / 14Q	24.4125-1701.3	010867	BOS Ø 25,4 ohne Bremsflüssigkeitsbehälter

	kw					! #		
CITROËN - JUMPER II Bus 04/06→								
 Hauptbremszylinder								
2.2 HDi 130	96	07/11→		Nutzlast ab [kg] 1200 Nutzlast bis [kg] 1400; - DSC; nicht für Facelift; Nutzlast-Code: 12Q / 14Q		24.4125-1702.3	010872	BOS Ø 25,4 ohne Bremsflüssigkeitsbehälter
2.2 HDi 150	110	07/11→						
3.0 HDi 155	115	07/10→						
3.0 HDi 160	116	09/06→		Nutzlast ab [kg] 1200 Nutzlast bis [kg] 1600; - DSC; für Facelift; Nutzlast-Code: 12Q / 14Q / 16Q		24.4125-1717.3	011157	BOS Ø 25,4 ohne Bremsflüssigkeitsbehälter
3.0 HDi 180	130	07/11→						
				Nutzlast ab [kg] 1200 Nutzlast bis [kg] 1600; + DSC; für Facelift; Nutzlast-Code: 12Q / 14Q / 16Q		24.4125-1718.3	011158	BOS Ø 25,4 ohne Bremsflüssigkeitsbehälter
				Nutzlast ab [kg] 1600 Nutzlast bis [kg] 2000; + DSC; nicht für Facelift; Nutzlast-Code: 16Q / 20Q		24.4126-1701.3	010868	BOS Ø 27 ohne Bremsflüssigkeitsbehälter
				Nutzlast ab [kg] 1600 Nutzlast bis [kg] 2000; - DSC; nicht für Facelift; Nutzlast-Code: 16Q / 20Q		24.4126-1702.3	010875	BOS Ø 27 ohne Bremsflüssigkeitsbehälter
				Nutzlast [kg]: 2000; - DSC; für Facelift; Nutzlast-Code: 20Q		24.4126-1704.3	011159	Ø 27 ohne Bremsflüssigkeitsbehälter
				Nutzlast [kg]: 2000; + DSC; für Facelift; Nutzlast-Code: 20Q		24.4126-1705.3	011160	Ø 27 ohne Bremsflüssigkeitsbehälter
CITROËN - JUMPER II Kasten 04/06→								
 Hauptbremszylinder								
2.0 BlueHDi 110	81	11/15→09/19		Nutzlast ab [kg] 1200 Nutzlast bis [kg] 1600; - DSC; Nutzlast-Code: 12Q / 14Q / 16Q		24.4125-1717.3	011157	BOS Ø 25,4 ohne Bremsflüssigkeitsbehälter
2.0 BlueHDi 130	96	11/15→09/19						
2.0 BlueHDi 130 4x4	96	11/15→09/19						
2.0 BlueHDi 160	120	11/15→09/19		Nutzlast ab [kg] 1200 Nutzlast bis [kg] 1600; + DSC; Nutzlast-Code: 12Q / 14Q / 16Q		24.4125-1718.3	011158	BOS Ø 25,4 ohne Bremsflüssigkeitsbehälter
2.0 BlueHDi 160 4x4	120	11/15→09/19						
2.2 BlueHDi 120	88	08/19→						
2.2 BlueHDi 140	103	08/19→						
2.2 BlueHDi 165	121	08/19→10/23		Nutzlast [kg]: 2000; - DSC; Nutzlast-Code: 20Q		24.4126-1704.3	011159	Ø 27 ohne Bremsflüssigkeitsbehälter
2.2 BlueHDi 180	132	11/23→						
ë-JUMPER	100	07/21→10/23		Nutzlast [kg]: 2000; + DSC; Nutzlast-Code: 20Q		24.4126-1705.3	011160	Ø 27 ohne Bremsflüssigkeitsbehälter
2.2 HDi 100	74	04/06→12/12		Nutzlast ab [kg] 1200 Nutzlast bis [kg] 1400; + DSC; nicht für Facelift; Nutzlast-Code: 12Q / 14Q		24.4125-1701.3	010867	BOS Ø 25,4 ohne Bremsflüssigkeitsbehälter
				Nutzlast ab [kg] 1200 Nutzlast bis [kg] 1400; - DSC; nicht für Facelift; Nutzlast-Code: 12Q / 14Q		24.4125-1702.3	010872	BOS Ø 25,4 ohne Bremsflüssigkeitsbehälter
				Nutzlast ab [kg] 1600 Nutzlast bis [kg] 2000; + DSC; nicht für Facelift; Nutzlast-Code: 16Q / 20Q		24.4126-1701.3	010868	BOS Ø 27 ohne Bremsflüssigkeitsbehälter
				Nutzlast ab [kg] 1600 Nutzlast bis [kg] 2000; - DSC; nicht für Facelift; Nutzlast-Code: 16Q / 20Q		24.4126-1702.3	010875	BOS Ø 27 ohne Bremsflüssigkeitsbehälter
2.2 HDi 110	81	07/11→12/20		Nutzlast ab [kg] 1200 Nutzlast bis [kg] 1400; + DSC; nicht für Facelift; Nutzlast-Code: 12Q / 14Q		24.4125-1701.3	010867	BOS Ø 25,4 ohne Bremsflüssigkeitsbehälter
2.2 HDi 120	88	04/06→12/16						
2.2 HDi 130	96	07/11→						
2.2 HDi 130 4x4	96	01/12→05/16		Nutzlast ab [kg] 1200 Nutzlast bis [kg] 1400; - DSC; nicht für Facelift; Nutzlast-Code: 12Q / 14Q		24.4125-1702.3	010872	BOS Ø 25,4 ohne Bremsflüssigkeitsbehälter
2.2 HDi 150	110	07/11→						
3.0 HDi 145	107	07/10→12/13						
3.0 HDi 155	115	07/10→12/15		Nutzlast ab [kg] 1200 Nutzlast bis [kg] 1600; - DSC; für Facelift; Nutzlast-Code: 12Q / 14Q / 16Q		24.4125-1717.3	011157	BOS Ø 25,4 ohne Bremsflüssigkeitsbehälter
3.0 HDi 160	116	09/06→12/15						
3.0 HDi 180	130	07/11→		Nutzlast ab [kg] 1200 Nutzlast bis [kg] 1600; + DSC; für Facelift; Nutzlast-Code: 12Q / 14Q / 16Q		24.4125-1718.3	011158	BOS Ø 25,4 ohne Bremsflüssigkeitsbehälter
				Nutzlast ab [kg] 1600 Nutzlast bis [kg] 2000; + DSC; nicht für Facelift; Nutzlast-Code: 16Q / 20Q		24.4126-1701.3	010868	BOS Ø 27 ohne Bremsflüssigkeitsbehälter
				Nutzlast ab [kg] 1600 Nutzlast bis [kg] 2000; - DSC; nicht für Facelift; Nutzlast-Code: 16Q / 20Q		24.4126-1702.3	010875	BOS Ø 27 ohne Bremsflüssigkeitsbehälter
				Nutzlast [kg]: 2000; - DSC; für Facelift; Nutzlast-Code: 20Q		24.4126-1704.3	011159	Ø 27 ohne Bremsflüssigkeitsbehälter
				Nutzlast [kg]: 2000; + DSC; für Facelift; Nutzlast-Code: 20Q		24.4126-1705.3	011160	Ø 27 ohne Bremsflüssigkeitsbehälter
CITROËN - JUMPER II Pritsche/Fahrgestell 04/06→								
 Hauptbremszylinder								
2.0 BlueHDi 110	81	11/15→09/19		Nutzlast ab [kg] 1200 Nutzlast bis [kg] 1600; - DSC; Nutzlast-Code: 12Q / 14Q / 16Q		24.4125-1717.3	011157	BOS Ø 25,4 ohne Bremsflüssigkeitsbehälter
2.0 BlueHDi 130	96	11/15→09/19						
2.0 BlueHDi 130 4x4	96	11/15→09/19						
2.0 BlueHDi 160	120	11/15→09/19		Nutzlast ab [kg] 1200 Nutzlast bis [kg] 1600; + DSC; Nutzlast-Code: 12Q / 14Q / 16Q		24.4125-1718.3	011158	BOS Ø 25,4 ohne Bremsflüssigkeitsbehälter
2.0 BlueHDi 160 4x4	120	11/15→09/19						
2.2 BlueHDi 120	88	08/19→						
→								



	kW					! #		
CITROËN - JUMPER II Pritsche/Fahrgestell 04/06→								
 Hauptbremszylinder								
2.2 BlueHDi 140	103	08/19→		Nutzlast [kg]: 2000; - DSC; Nutzlast-Code: 20Q		24.4126-1704.3	011159	Ø 27 ohne Bremsflüssigkeitsbehälter
2.2 BlueHDi 165	121	08/19→10/23						
2.2 BlueHDi 180	132	11/23→						
ë-Jumper	100	03/22→10/23		Nutzlast [kg]: 2000; + DSC; Nutzlast-Code: 20Q		24.4126-1705.3	011160	Ø 27 ohne Bremsflüssigkeitsbehälter
2.2 HDi 100	74	04/06→		Nutzlast ab [kg] 1200 Nutzlast bis [kg] 1400; + DSC; nicht für Facelift; Nutzlast-Code: 12Q / 14Q		24.4125-1701.3	010867	BOS Ø 25,4 ohne Bremsflüssigkeitsbehälter
2.2 HDi 110	81	07/11→12/20						
2.2 HDi 120	88	04/06→12/16						
2.2 HDi 130	96	07/11→						
2.2 HDi 150	110	07/11→		Nutzlast ab [kg] 1200 Nutzlast bis [kg] 1400; - DSC; nicht für Facelift; Nutzlast-Code: 12Q / 14Q		24.4125-1702.3	010872	BOS Ø 25,4 ohne Bremsflüssigkeitsbehälter
3.0 HDi 145	107	07/10→12/13						
3.0 HDi 160	116	09/06→12/15						
3.0 HDi 180	130	07/11→		Nutzlast ab [kg] 1200 Nutzlast bis [kg] 1600; - DSC; für Facelift; Nutzlast-Code: 12Q / 14Q / 16Q		24.4125-1717.3	011157	BOS Ø 25,4 ohne Bremsflüssigkeitsbehälter
				Nutzlast ab [kg] 1200 Nutzlast bis [kg] 1600; + DSC; für Facelift; Nutzlast-Code: 12Q / 14Q / 16Q		24.4125-1718.3	011158	BOS Ø 25,4 ohne Bremsflüssigkeitsbehälter
				Nutzlast ab [kg] 1600 Nutzlast bis [kg] 2000; + DSC; nicht für Facelift; Nutzlast-Code: 16Q / 20Q		24.4126-1701.3	010868	BOS Ø 27 ohne Bremsflüssigkeitsbehälter
				Nutzlast ab [kg] 1600 Nutzlast bis [kg] 2000; - DSC; nicht für Facelift; Nutzlast-Code: 16Q / 20Q		24.4126-1702.3	010875	BOS Ø 27 ohne Bremsflüssigkeitsbehälter
				Nutzlast [kg]: 2000; - DSC; für Facelift; Nutzlast-Code: 20Q		24.4126-1704.3	011159	Ø 27 ohne Bremsflüssigkeitsbehälter
				Nutzlast [kg]: 2000; + DSC; für Facelift; Nutzlast-Code: 20Q		24.4126-1705.3	011160	Ø 27 ohne Bremsflüssigkeitsbehälter
CITROËN - JUMPY I (U6U_) 06/94→12/06								
 Hauptbremszylinder								
1.6	58	10/95→08/00		→Orga 08206; - ABS; Nutzlast [kg]: 800		24.2122-1703.3	010422	Ø 22,2
1.9 D 70	51	04/98→11/03		→Orga 08206; + ABS; Nutzlast [kg]: 800		24.2122-1708.3	010437	Ø 22,2
1.9 TD	66 - 68	10/95→11/03		Orga 08207→; - ABS; Nutzlast [kg]: 800		24.2122-1741.3	010695	Ø 22,2
				→Orga 08206; - ABS; Nutzlast [kg]: 900		24.2123-1707.3	010492	Ø 23,8
				Orga 08207→; + ABS; Nutzlast [kg]: 900		24.2123-1733.3	010657	BOS Ø 23,8
				Orga 08207→; - ABS; Nutzlast [kg]: 900		24.2123-1738.3	010658	Ø 23,8
2.0	100	04/00→12/06		+ ABS		24.2123-1733.3	010657	BOS Ø 23,8
2.0 HDi 110	80	03/00→10/06		- ABS		24.2123-1738.3	010658	Ø 23,8
2.0 HDi 95	69	10/99→10/06						
2.0 i 16V	102	03/00→10/06						
CITROËN - JUMPY I Kasten (BS_, BT_, BY_, BZ_) 06/94→10/06								
 Hauptbremszylinder								
1.6 i	58	10/95→08/00		→Orga 08206; - ABS; Nutzlast [kg]: 800		24.2122-1703.3	010422	Ø 22,2
1.9 D 70	51	04/98→10/06		→Orga 08206; + ABS; Nutzlast [kg]: 800		24.2122-1708.3	010437	Ø 22,2
1.9 DT	65	10/95→08/00		Orga 08207→; - ABS; Nutzlast [kg]: 800		24.2122-1741.3	010695	Ø 22,2
1.9 TD	66	10/95→08/00		→Orga 08206; - ABS; Nutzlast [kg]: 900		24.2123-1707.3	010492	Ø 23,8
				Orga 08207→; + ABS; Nutzlast [kg]: 900		24.2123-1733.3	010657	BOS Ø 23,8
				Orga 08207→; - ABS; Nutzlast [kg]: 900		24.2123-1738.3	010658	Ø 23,8
2.0	100	04/00→10/06		+ ABS		24.2123-1733.3	010657	BOS Ø 23,8
2.0 HDi 110	80	01/02→10/06		- ABS		24.2123-1738.3	010658	Ø 23,8
2.0 HDi 95	69	10/99→10/06						
2.0 i 16V	102	03/00→10/06						
2.0 HDi 110	80	10/01→10/06		01/02→; + ABS		24.2123-1733.3	010657	BOS Ø 23,8
				01/02→; - ABS		24.2123-1738.3	010658	Ø 23,8
CITROËN - JUMPY I Pritsche/Fahrgestell (BU_, BV_, BW_, BX_) 10/99→10/06								
 Hauptbremszylinder								
1.9 TD	51	11/00→10/06		→Orga 08206; - ABS; Nutzlast [kg]: 800		24.2122-1703.3	010422	Ø 22,2
				→Orga 08206; + ABS; Nutzlast [kg]: 800		24.2122-1708.3	010437	Ø 22,2
				Orga 08207→; - ABS; Nutzlast [kg]: 800		24.2122-1741.3	010695	Ø 22,2
				→Orga 08206; - ABS; Nutzlast [kg]: 900		24.2123-1707.3	010492	Ø 23,8
				Orga 08207→; + ABS; Nutzlast [kg]: 900		24.2123-1733.3	010657	BOS Ø 23,8
				Orga 08207→; - ABS; Nutzlast [kg]: 900		24.2123-1738.3	010658	Ø 23,8
1.9 TD	68	10/99→10/06		- ABS; Nutzlast [kg]: 800		24.2122-1741.3	010695	Ø 22,2
				+ ABS; Nutzlast [kg]: 900		24.2123-1733.3	010657	BOS Ø 23,8
				- ABS; Nutzlast [kg]: 900		24.2123-1738.3	010658	Ø 23,8
2.0	100	12/03→10/06		+ ABS		24.2123-1733.3	010657	BOS Ø 23,8
2.0 HDi 110	80	12/03→10/06						
→								

	kw					! #		
CITROËN - JUMPY I Pritsche/Fahrgestell (BU_, BV_, BW_, BX_) 10/99→10/06								
 Hauptbremszylinder								
2.0 HDi 110 16V	80	12/03→10/06		- ABS		24.2123-1738.3	010658	Ø 23,8
2.0 HDi 95	69	10/99→10/06						
CITROËN - JUMPY II (VF7) 01/07→03/16								
 Hauptbremszylinder								
1.6 HDi 90 16V	66	01/07→03/16		für Linkslenker; + ESP		03.2125-0671.3	010965	ATE Ø 25,4
1.6 HDi 90 8V	66	01/07→03/16		für Linkslenker; - ESP		03.2125-0676.3	011009	ATE Ø 25,4 ohne Bremsflüssigkeitsbehälter
2.0 HDi 120	88	01/07→03/16						
2.0 HDi 125	94	07/11→03/16						
2.0 HDi 140	100	01/07→03/16		für Rechtslenker; - ESP		24.2123-3396.3	011035	ATE Ø 23,8 ohne Bremsflüssigkeitsbehälter
2.0 HDi 165	120	07/10→03/16						
2.0 HDi 95	72	07/11→03/16						
2.0 i	103	01/07→03/16						
CITROËN - JUMPY II Kasten 01/07→03/16								
 Hauptbremszylinder								
1.6 HDi 90 16V	66	01/07→03/16		für Linkslenker; + ESP		03.2125-0671.3	010965	ATE Ø 25,4
1.6 HDi 90 8V	66	01/07→03/16		für Linkslenker; - ESP		03.2125-0676.3	011009	ATE Ø 25,4 ohne Bremsflüssigkeitsbehälter
2.0 HDi 120	88	01/07→03/16						
2.0 HDi 120 4x4	88	01/10→03/16						
2.0 HDi 125	94	07/11→03/16		für Rechtslenker; - ESP		24.2123-3396.3	011035	ATE Ø 23,8 ohne Bremsflüssigkeitsbehälter
2.0 HDi 125 4x4	94	07/11→03/16						
2.0 HDi 140	100	01/07→03/16						
2.0 HDi 165	120	07/10→03/16						
2.0 HDi 95	72	07/11→03/16						
2.0 i	103	01/07→03/16						
CITROËN - JUMPY II Pritsche/Fahrgestell 11/06→								
 Hauptbremszylinder								
1.6 HDi 90 16V	66	06/07→03/16		für Linkslenker; + ESP		03.2125-0671.3	010965	ATE Ø 25,4
1.6 HDi 90 8V	66	06/07→03/16		für Linkslenker; - ESP		03.2125-0676.3	011009	ATE Ø 25,4 ohne Bremsflüssigkeitsbehälter
2.0 HDi	88 - 120	01/09→03/16						
2.0 HDi 100	72	07/11→03/16		für Rechtslenker; - ESP		24.2123-3396.3	011035	ATE Ø 23,8 ohne Bremsflüssigkeitsbehälter
2.0 HDi 125	94	07/11→						
2.0 i	103	11/06→03/16						
CITROËN - SAXO (S0, S1) 02/96→04/04								
 Hauptbremszylinder								
1.0 X	37	05/98→06/03		- ABS; Felge Lochzahl: 3		03.2120-4166.3	010452	ATE Ø 20,6
1.1 BiFuel	44	07/00→06/03				24.2120-1722.3	010544	Ø 20,6
1.1 X	40 - 44	05/96→09/03		- ABS; Felge Lochzahl: 4		24.2119-1708.3	010543	BDX Ø 19
SX	40 - 44	05/96→09/03						
1.4 VTS	55	05/96→06/03		- ABS		03.2120-4166.3	010452	ATE Ø 20,6
1.5 D	40 - 43	09/96→04/04				24.2120-1722.3	010544	Ø 20,6
1.6	66 - 88	02/96→04/04				24.2119-1708.3	010543	BDX Ø 19
VTR	65	05/96→06/03						
1.6 VTL	65	05/96→06/03						
1.6 VTS	72	09/00→09/03						
Electric	20	11/96→06/03						
1.6 VTS	87	06/96→09/03		07/96→; - ABS		03.2120-4166.3	010452	ATE Ø 20,6
				07/96→		24.2120-1722.3	010544	Ø 20,6
						24.2119-1708.3	010543	BDX Ø 19
CITROËN - SAXO Hatchback van (S3_) 10/97→06/03								
 Hauptbremszylinder								
1.0	33 - 37	10/97→06/03		- ABS; Felge Lochzahl: 3		03.2120-4166.3	010452	ATE Ø 20,6
				- ABS; Felge Lochzahl: 4		24.2120-1722.3	010544	Ø 20,6
						24.2119-1708.3	010543	BDX Ø 19
1.5 D	42 - 43	08/99→06/03		- ABS		03.2120-4166.3	010452	ATE Ø 20,6
						24.2120-1722.3	010544	Ø 20,6
						24.2119-1708.3	010543	BDX Ø 19
CITROËN - XSARA (N1) 04/97→12/05								
 Bremskraftverstärker								
1.4 HDi	50	01/03→03/05		für Linkslenker; + ABS		03.7853-0902.4	300150	ATE Ø 9" pneumatisch
1.4 i	55	04/97→03/05		→ 08/00		03.7750-9302.4	300116	ATE Ø 9" pneumatisch
1.9 D	51	07/98→03/05						
2.0 HDi 90	66	02/99→03/05		Orga 09002→; für Linkslenker; + ABS		03.7853-0902.4	300150	ATE Ø 9" pneumatisch
→								

CITROËN - XSARA (N1) 04/97→12/05

Bremskraftverstärker

1.4 LPG	55	05/98→08/00			03.7750-9302.4	300116	ATE Ø 9" pneumatisch
				Orga 09002→; für Linkslenker; + ABS	03.7853-0902.4	300150	ATE Ø 9" pneumatisch
1.5 D	42	04/97→09/00		→ 08/00	03.7750-9302.4	300116	ATE Ø 9" pneumatisch
1.6 i	65	04/97→09/00					
1.8 D	43	04/97→09/00					
1.8 i	66	04/97→09/00					
1.8 i Aut.	74	04/97→09/00					
1.9 D	50	04/97→09/00					
1.9 SD	55	01/98→09/00					
1.9 TD	66	04/97→09/00					
1.6 16V	80	09/00→03/05		Orga 09002→; für Linkslenker; + ABS	03.7853-0902.4	300150	ATE Ø 9" pneumatisch
2.0 16V	100	09/00→03/05					
2.0 HDi 109	80	05/01→03/05					
1.9 D	52	04/00→04/05		→ 08/00	03.7750-9302.4	300116	ATE Ø 9" pneumatisch
				Orga 09002→; → 03/05; für Linkslenker; + ABS	03.7853-0902.4	300150	ATE Ø 9" pneumatisch











Hauptbremszylinder

1.4 HDi	50	01/03→03/05		+ ESP	03.2123-2761.3	010886	ATE Ø 23,8
				- ABS	03.2123-2781.3	010631	ATE Ø 23,8
1.4 i 1.9 D 2.0 HDi 90	55	04/97→03/05 07/98→03/05 02/99→03/05		→ 08/00; + ABS	03.2122-1351.3	010528	Ø 22,2
					24.2122-1733.3	010668	Ø 22,2
				→ 08/00; - ABS	03.2122-1356.3	010529	Ø 22,2
					24.2122-1743.3	010712	Ø 22,2
				Orga 09065→; + ESP	03.2123-2761.3	010886	ATE Ø 23,8
				Orga 09002→; - ABS	03.2123-2781.3	010631	ATE Ø 23,8
				09/00→; →Orga 09001; - ABS	24.2123-1714.3	010587	BDX Ø 23,8
				09/00→; →Orga 09001; + ABS	24.2123-1715.3	010520	BDX Ø 23,8
1.4 LPG	55	05/98→08/00		+ ABS	03.2122-1351.3	010528	Ø 22,2
				- ABS	03.2122-1356.3	010529	Ø 22,2
					24.2122-1743.3	010712	Ø 22,2
				Orga 09065→; + ESP	03.2123-2761.3	010886	ATE Ø 23,8
1.5 D 1.6 i 1.8 D 1.8 i 1.8 i Aut. 1.9 D 1.9 SD 1.9 TD	42 65 43 66 74 50 55 66	04/97→09/00 04/97→09/00 04/97→09/00 04/97→09/00 04/97→09/00 04/97→09/00 01/98→09/00 04/97→09/00		→ 08/00; + ABS	03.2122-1351.3	010528	Ø 22,2
					24.2122-1733.3	010668	Ø 22,2
				→ 08/00; - ABS	03.2122-1356.3	010529	Ø 22,2
					24.2122-1743.3	010712	Ø 22,2
				Orga 09065→; + ESP	03.2123-2761.3	010886	ATE Ø 23,8
				Orga 09002→; - ABS	03.2123-2781.3	010631	ATE Ø 23,8
				→Orga 09001; - ABS	24.2123-1714.3	010587	BDX Ø 23,8
				→Orga 09001; + ABS	24.2123-1715.3	010520	BDX Ø 23,8
1.6 16V 2.0 HDi 109	80 80	09/00→03/05 05/01→03/05		Orga 09065→; + ESP	03.2123-2761.3	010886	ATE Ø 23,8
				Orga 09002→; - ABS	03.2123-2781.3	010631	ATE Ø 23,8
				→Orga 09001; - ABS	24.2123-1714.3	010587	BDX Ø 23,8
				→Orga 09001; + ABS	24.2123-1715.3	010520	BDX Ø 23,8
1.8 BiFuel	82	07/97→08/00		- ABS	24.2123-1714.3	010587	BDX Ø 23,8
				+ ABS	24.2123-1715.3	010520	BDX Ø 23,8
1.8 i 16V 2.0 16V	81 97	04/97→09/00 07/98→09/00		→ 08/00; - ABS	24.2123-1714.3	010587	BDX Ø 23,8
				→ 08/00; + ABS	24.2123-1715.3	010520	BDX Ø 23,8
1.9 D	52	04/00→04/05		→ 08/00; + ABS	03.2122-1351.3	010528	Ø 22,2
					24.2122-1733.3	010668	Ø 22,2
				→ 08/00; - ABS	03.2122-1356.3	010529	Ø 22,2
					24.2122-1743.3	010712	Ø 22,2
				Orga 09065→; → 03/05; + ESP	03.2123-2761.3	010886	ATE Ø 23,8
				Orga 09002→; → 03/05; - ABS	03.2123-2781.3	010631	ATE Ø 23,8
				09/00→; →Orga 09001; - ABS	24.2123-1714.3	010587	BDX Ø 23,8
				09/00→; →Orga 09001; + ABS	24.2123-1715.3	010520	BDX Ø 23,8
2.0 16V	100	09/00→03/05		Orga 09065→; + ESP	03.2123-2761.3	010886	ATE Ø 23,8
				Orga 09002→; - ABS	03.2123-2781.3	010631	ATE Ø 23,8













CITROËN - XSARA Break (N2) 10/97→03/10













Bremskraftverstärker











1.4 HDi	50	01/03→08/05		für Linkslenker; + ABS	03.7853-0902.4	300150	ATE Ø 9" pneumatisch
1.4 i	55	10/97→08/05		→ 08/00; - ABS	03.7750-9302.4	300116	ATE Ø 9" pneumatisch
1.9 D	51	07/98→08/05					
2.0 HDi 90	66	02/99→08/05		Orga 09002→; für Linkslenker; + ABS	03.7853-0902.4	300150	ATE Ø 9" pneumatisch
→							













	kW					! #		
CITROËN - XSARA Break (N2) 10/97→03/10								
 Bremskraftverstärker								
1.5 D	42	10/97→09/00		→ 08/00; - ABS		03.7750-9302.4	300116	ATE Ø 9" pneumatisch
1.6 i	65	10/97→09/00						
1.8 D	43	10/97→09/00						
1.9 D	50 - 55	10/97→09/00						
1.9 TD	66	10/97→09/00						
1.6 16V	80	09/00→08/05		Orga 09002→; für Linkslenker; + ABS		03.7853-0902.4	300150	ATE Ø 9" pneumatisch
2.0 16V	100	09/00→08/05						
2.0 HDi 109	80	05/01→08/05						
 Hauptbremszylinder								
1.4 HDi	50	01/03→08/05		+ ESP		03.2123-2761.3	010886	ATE Ø 23,8
				- ABS		03.2123-2781.3	010631	ATE Ø 23,8
1.4 i	55	10/97→08/05		→ 08/00; - ABS		03.2122-1356.3	010529	Ø 22,2
				Orga 09065→; + ESP		03.2123-2761.3	010886	ATE Ø 23,8
				Orga 09002→; - ABS		03.2123-2781.3	010631	ATE Ø 23,8
				→Orga 09001; - ABS		24.2123-1714.3	010587	BDX Ø 23,8
				→Orga 09001; + ABS		24.2123-1715.3	010520	BDX Ø 23,8
1.5 D	42	10/97→09/00		→ 08/00; - ABS		03.2122-1356.3	010529	Ø 22,2
1.6 i	65	10/97→09/00				24.2123-1714.3	010587	BDX Ø 23,8
1.8 D	43	10/97→09/00						
1.9 D	50	10/97→09/00		→ 08/00; + ABS		24.2123-1715.3	010520	BDX Ø 23,8
1.6 16V	80	09/00→08/05		Orga 09065→; + ESP		03.2123-2761.3	010886	ATE Ø 23,8
2.0 16V	100	09/00→08/05		Orga 09002→; - ABS		03.2123-2781.3	010631	ATE Ø 23,8
2.0 HDi 109	80	05/01→08/05		→Orga 09001; - ABS		24.2123-1714.3	010587	BDX Ø 23,8
2.0 HDi 90	66	02/99→08/05		→Orga 09001; + ABS		24.2123-1715.3	010520	BDX Ø 23,8
1.8 i	66	10/97→09/00		→ 08/00; - ABS		24.2123-1714.3	010587	BDX Ø 23,8
1.8 i 16V	81	10/97→09/00						
1.8 i Aut.	74	10/97→09/00		→ 08/00; + ABS		24.2123-1715.3	010520	BDX Ø 23,8
1.9 D	55	01/98→09/00						
1.9 TD	66	10/97→09/00						
2.0 16V	97	07/98→09/00						
1.8 LPG	81	05/98→08/00		- ABS		24.2123-1714.3	010587	BDX Ø 23,8
				+ ABS		24.2123-1715.3	010520	BDX Ø 23,8
1.9 D	51	07/98→08/05		Orga 09065→; + ESP		03.2123-2761.3	010886	ATE Ø 23,8
				Orga 09002→; - ABS		03.2123-2781.3	010631	ATE Ø 23,8
CITROËN - XSARA Coupe (N0) 01/98→04/05								
 Bremskraftverstärker								
1.4 HDi	50	01/03→03/05		für Linkslenker; + ABS		03.7853-0902.4	300150	ATE Ø 9" pneumatisch
1.4 i	55	03/98→03/05		→ 08/00		03.7750-9302.4	300116	ATE Ø 9" pneumatisch
1.9 D	51	02/99→03/05		Orga 09002→; für Linkslenker; + ABS		03.7853-0902.4	300150	ATE Ø 9" pneumatisch
2.0 HDi 90	66	02/99→03/05						
1.6 16V	80	09/00→03/05		Orga 09002→; für Linkslenker; + ABS		03.7853-0902.4	300150	ATE Ø 9" pneumatisch
2.0 16V	100	09/00→03/05						
2.0 HDi 109	80	05/01→03/05						
2.0 i 16V	120	02/98→03/05						
1.6 i	65	02/98→09/00		→ 08/00		03.7750-9302.4	300116	ATE Ø 9" pneumatisch
1.8 i	66 - 74	02/98→09/00						
1.8 i 16V	81	02/98→09/00						
1.9 D	50	02/98→09/00						
1.9 TD	66	02/98→09/00						
1.8 LPG	82	01/98→08/00		02/98→		03.7750-9302.4	300116	ATE Ø 9" pneumatisch
 Hauptbremszylinder								
1.4 HDi	50	01/03→03/05		+ ESP		03.2123-2761.3	010886	ATE Ø 23,8
				- ABS		03.2123-2781.3	010631	ATE Ø 23,8
1.4 i	55	03/98→03/05		→ 08/00; + ABS		03.2122-1351.3	010528	Ø 22,2
1.9 D	51	02/99→03/05				24.2122-1733.3	010668	Ø 22,2
2.0 HDi 90	66	02/99→03/05		→ 08/00; - ABS		03.2122-1356.3	010529	Ø 22,2
						24.2122-1743.3	010712	Ø 22,2
				Orga 09065→; + ESP		03.2123-2761.3	010886	ATE Ø 23,8
				Orga 09002→; - ABS		03.2123-2781.3	010631	ATE Ø 23,8
				09/00→; →Orga 09001; - ABS		24.2123-1714.3	010587	BDX Ø 23,8
				09/00→; →Orga 09001; + ABS		24.2123-1715.3	010520	BDX Ø 23,8
1.6 16V	80	09/00→03/05		Orga 09065→; + ESP		03.2123-2761.3	010886	ATE Ø 23,8
2.0 16V	100	09/00→03/05		Orga 09002→; - ABS		03.2123-2781.3	010631	ATE Ø 23,8
2.0 HDi 109	80	05/01→03/05		→Orga 09001; - ABS		24.2123-1714.3	010587	BDX Ø 23,8
2.0 i 16V	120	02/98→03/05						
→								



























	kw					! #		
CITROËN - XSARA Coupe (N0) 01/98→04/05								
 Hauptbremszylinder								
1.6 16V 2.0 16V 2.0 HDi 109 2.0 i 16V	80 100 80 120	09/00→03/05 09/00→03/05 05/01→03/05 02/98→03/05			→Orga 09001; + ABS		24.2123-1715.3 010520	BDX Ø 23,8
1.6 i 1.8 i	65 66 - 74	02/98→09/00 02/98→09/00			→ 08/00; + ABS		03.2122-1351.3 010528 24.2122-1733.3 010668	Ø 22,2 Ø 22,2
1.9 D 1.9 TD	50 66	02/98→09/00 02/98→09/00			→ 08/00; - ABS		03.2122-1356.3 010529 24.2122-1743.3 010712	Ø 22,2 Ø 22,2
1.8 i 16V	81	02/98→09/00			→ 08/00; - ABS		24.2123-1714.3 010587	BDX Ø 23,8
					→ 08/00; + ABS		24.2123-1715.3 010520	BDX Ø 23,8
1.8 LPG	82	01/98→08/00			02/98→; - ABS		24.2123-1714.3 010587	BDX Ø 23,8
					02/98→; + ABS		24.2123-1715.3 010520	BDX Ø 23,8
CITROËN - XSARA Kasten/Kombi 05/98→08/05								
 Bremskraftverstärker								
1.4 2.0 HDi	55 66	09/00→03/05 09/00→03/05			Orga 09002→; für Linkslenker; + ABS		03.7853-0902.4 300150	ATE Ø 9" pneumatisch
1.9 D	51	06/99→08/05			→ 08/00; - ABS		03.7750-9302.4 300116	ATE Ø 9" pneumatisch
					Orga 09002→; für Linkslenker; + ABS		03.7853-0902.4 300150	ATE Ø 9" pneumatisch
 Hauptbremszylinder								
1.4 2.0 HDi	55 66	09/00→03/05 09/00→03/05			Orga 09065→; + ESP		03.2123-2761.3 010886	ATE Ø 23,8
					Orga 09002→; - ABS		03.2123-2781.3 010631	ATE Ø 23,8
					→Orga 09001; - ABS		24.2123-1714.3 010587	BDX Ø 23,8
					→Orga 09001; + ABS		24.2123-1715.3 010520	BDX Ø 23,8
1.9 D	51	06/99→08/05			Orga 09065→; + ESP		03.2123-2761.3 010886	ATE Ø 23,8
					Orga 09002→; - ABS		03.2123-2781.3 010631	ATE Ø 23,8
CITROËN - XSARA Kasten/Schrägheck (N3_) 05/98→03/05								
 Bremskraftverstärker								
1.4 1.9 D	55 51	05/98→10/04 06/99→03/05			→ 08/00		03.7750-9302.4 300116	ATE Ø 9" pneumatisch
					Orga 09002→; für Linkslenker; + ABS		03.7853-0902.4 300150	ATE Ø 9" pneumatisch
1.4 LPG	55	06/99→08/00					03.7750-9302.4 300116	ATE Ø 9" pneumatisch
					Orga 09002→; für Linkslenker; + ABS		03.7853-0902.4 300150	ATE Ø 9" pneumatisch
1.9 D	65	05/98→08/00					03.7750-9302.4 300116	ATE Ø 9" pneumatisch
2.0 HDi	66	09/00→03/05			Orga 09002→; für Linkslenker; + ABS		03.7853-0902.4 300150	ATE Ø 9" pneumatisch
 Hauptbremszylinder								
1.4 1.9 D	55 51	05/98→10/04 06/99→03/05			→ 08/00; + ABS		03.2122-1351.3 010528	Ø 22,2
					→ 08/00; - ABS		24.2122-1733.3 010668	Ø 22,2
					→ 08/00; - ABS		03.2122-1356.3 010529	Ø 22,2
					→ 08/00; - ABS		24.2122-1743.3 010712	Ø 22,2
					Orga 09065→; + ESP		03.2123-2761.3 010886	ATE Ø 23,8
					Orga 09002→; - ABS		03.2123-2781.3 010631	ATE Ø 23,8
					09/00→; →Orga 09001; - ABS		24.2123-1714.3 010587	BDX Ø 23,8
					09/00→; →Orga 09001; + ABS		24.2123-1715.3 010520	BDX Ø 23,8
1.4 LPG	55	06/99→08/00			+ ABS		03.2122-1351.3 010528	Ø 22,2
					- ABS		24.2122-1733.3 010668	Ø 22,2
					- ABS		03.2122-1356.3 010529	Ø 22,2
					- ABS		24.2122-1743.3 010712	Ø 22,2
					Orga 09065→; + ESP		03.2123-2761.3 010886	ATE Ø 23,8
					Orga 09002→; - ABS		03.2123-2781.3 010631	ATE Ø 23,8
1.9 D	65	05/98→08/00			+ ABS		03.2122-1351.3 010528	Ø 22,2
					- ABS		24.2122-1733.3 010668	Ø 22,2
					- ABS		03.2122-1356.3 010529	Ø 22,2
					- ABS		24.2122-1743.3 010712	Ø 22,2
2.0 HDi	66	09/00→03/05			Orga 09065→; + ESP		03.2123-2761.3 010886	ATE Ø 23,8
					Orga 09002→; - ABS		03.2123-2781.3 010631	ATE Ø 23,8
					→Orga 09001; - ABS		24.2123-1714.3 010587	BDX Ø 23,8
					→Orga 09001; + ABS		24.2123-1715.3 010520	BDX Ø 23,8















	kw					! #		
CITROËN - XSARA PICASSO (N68) 09/99→06/12								
 Hauptbremszylinder								
1.6	65	12/99→09/01		für DAM-Nummer ab: 0882078 →; für Linkslenker; - ABS		03.2123-2781.3	010631	ATE Ø 23,8
				06/00→; - ABS		24.2123-1714.3	010587	BDX Ø 23,8
1.6	67	06/02→08/05		Orga 08820→; für Linkslenker; - ABS		03.2123-2781.3	010631	ATE Ø 23,8
				- ABS		24.2123-1714.3	010587	BDX Ø 23,8
1.6	70	12/99→12/10		für DAM-Nummer ab: 0882078 →; → 03/10; für Linkslenker; - ABS		03.2123-2781.3	010631	ATE Ø 23,8
				09/00→ 03/10; - ABS		24.2123-1714.3	010587	BDX Ø 23,8
1.6 16V	80	09/05→12/11		für Linkslenker; - ABS		03.2123-2781.3	010631	ATE Ø 23,8
1.6 16V LPG	80	06/04→12/10		- ABS		24.2123-1714.3	010587	BDX Ø 23,8
2.0	88	02/04→10/04						
1.6 16V	81	06/05→09/06		09/05→; für Linkslenker; - ABS		03.2123-2781.3	010631	ATE Ø 23,8
				09/05→; - ABS		24.2123-1714.3	010587	BDX Ø 23,8
1.6 Chrono	74	04/01→10/04		für DAM-Nummer ab: 0882078 →; für Linkslenker; - ABS		03.2123-2781.3	010631	ATE Ø 23,8
1.8 16V	85	02/00→08/05		- ABS		24.2123-1714.3	010587	BDX Ø 23,8
1.6 HDi	66 - 80	05/04→12/11		→ 03/10; für Linkslenker; - ABS		03.2123-2781.3	010631	ATE Ø 23,8
2.0 16V	100	01/03→06/12		→ 03/10; - ABS		24.2123-1714.3	010587	BDX Ø 23,8
2.0 16V	101	12/99→11/11		01/03→ 03/10; für Linkslenker; - ABS		03.2123-2781.3	010631	ATE Ø 23,8
				01/03→ 03/10; - ABS		24.2123-1714.3	010587	BDX Ø 23,8
2.0 HDi	66	12/99→12/11		für DAM-Nummer ab: 0882078 →; → 03/10; für Linkslenker; - ABS		03.2123-2781.3	010631	ATE Ø 23,8
				06/00→ 03/10; - ABS		24.2123-1714.3	010587	BDX Ø 23,8
CUPRA - ATECA (KH7, KHP, KBP) 09/18→								
 Hauptbremszylinder								
2.0 TSI 4Drive	140 - 221	09/18→		für Linkslenker		24.4123-1719.3	011017	TRW Ø 23,8 ohne Bremsflüssigkeitsbehälter
						24.4153-1522.3	011048	ATE Ø 23,8 ohne Bremsflüssigkeitsbehälter
DACIA - DOKKER Großraumlimousine (KE_) 11/12→12/21								
 Hauptbremszylinder								
1.2 TCe	85	11/12→12/21		- ESP		24.4152-0381.3	011032	ATE Ø 22,2 ohne Bremsflüssigkeitsbehälter
1.3 TCe 100	75	08/19→12/21						
1.3 TCe 130	96	03/19→12/21						
1.5 Blue dCi 95	70	12/18→12/21		+ ESP		24.4152-0391.3	011033	ATE Ø 22,2 ohne Bremsflüssigkeitsbehälter
1.5 dCi / Blue dCi 75	55	11/12→12/21						
1.5 dCi	63 - 66	11/12→12/21						
1.6	61 - 75	11/12→12/21						
1.6 LPG	61 - 80	11/13→12/21						
DACIA - DOKKER Kasten/Großraumlimousine 11/12→12/21								
 Hauptbremszylinder								
1.2 TCe 115	84 - 85	12/12→12/21		- ESP		24.4152-0381.3	011032	ATE Ø 22,2 ohne Bremsflüssigkeitsbehälter
1.3 TCe 100	75	08/19→12/21						
1.3 TCe 130	96	08/19→12/21		+ ESP		24.4152-0391.3	011033	ATE Ø 22,2 ohne Bremsflüssigkeitsbehälter
1.5 Blue dCi 95	70	06/19→12/21						
1.5 dCi	62 - 66	11/12→12/21						
1.5 dCi 75 / Blue dCi 75	55	12/12→12/21						
1.6	61 - 75	12/12→12/21						
1.6 LPG	61 - 80	11/13→12/21						
DACIA - DUSTER (HS_) 04/10→01/18								
 Bremskraftverstärker								
1.5 dCi	63 - 79	04/10→01/18		→ 10/13; + ABS		03.7853-4602.4	300302	ATE Ø 9" pneumatisch
1.5 dCi 4x4	66 - 81	10/10→01/18						
1.6 16V	77	04/10→01/18						
1.6 16V 4x4	77	06/10→01/18						
1.6 16V LPG	77	04/11→01/18						
1.5 dCi 4x4	80	08/13→01/18		+ ABS		03.7853-4602.4	300302	ATE Ø 9" pneumatisch
1.6 16V Hi-Flex →	77	08/10→01/18		04/11→ 10/13; + ABS		03.7853-4602.4	300302	ATE Ø 9" pneumatisch

















	kW					! #		
DACIA - DUSTER (HS_) 04/10→01/18								
 Hauptbremszylinder								
1.2 TCe 125 1.2 TCe 125 4x4 1.6 S Ce 115	92 92 84	10/13→01/18 06/15→01/18 06/15→01/18		+ ABS / - ESP + ABS / + ESP		24.4152-0381.3 24.4152-0391.3	011032 011033	ATE Ø 22,2 ohne Bremsflüssigkeitsbehälter ATE Ø 22,2 ohne Bremsflüssigkeitsbehälter
1.5 dCi 1.5 dCi 4x4 1.6 16V 1.6 16V 4x4 1.6 16V LPG	63-79 66-81 77 77 77	04/10→01/18 10/10→01/18 04/10→01/18 06/10→01/18 04/11→01/18		→ 10/13; - ESP → 10/13; + ESP 11/13→; + ABS / - ESP 11/13→; + ABS / + ESP		03.2122-2031.3 03.2122-2261.3 24.4152-0381.3 24.4152-0391.3	010938 010964 011032 011033	ATE Ø 22,2 ATE Ø 22,2 ATE Ø 22,2 ohne Bremsflüssigkeitsbehälter ATE Ø 22,2 ohne Bremsflüssigkeitsbehälter
1.5 dCi 4x4	80	08/13→01/18		+ ABS / - ESP + ABS / + ESP		03.2122-2031.3 03.2122-2261.3	010938 010964	ATE Ø 22,2 ATE Ø 22,2
1.6 16V Hi-Flex	77	08/10→01/18		04/11→ 10/13; - ESP 11/13→; + ABS / - ESP		03.2122-2031.3 24.4152-0381.3	010938 011032	ATE Ø 22,2 ATE Ø 22,2 ohne Bremsflüssigkeitsbehälter
1.6 S Ce 115 4x4	84	06/15→01/18		für Linkslenker; + ABS / - ESP für Linkslenker; + ABS / + ESP		24.4152-0381.3 24.4152-0391.3	011032 011033	ATE Ø 22,2 ohne Bremsflüssigkeitsbehälter ATE Ø 22,2 ohne Bremsflüssigkeitsbehälter
1.6 S Ce 115 LPG	84	06/15→01/18		für Linkslenker; + ABS / - ESP + ABS / + ESP		24.4152-0381.3 24.4152-0391.3	011032 011033	ATE Ø 22,2 ohne Bremsflüssigkeitsbehälter ATE Ø 22,2 ohne Bremsflüssigkeitsbehälter
DACIA - DUSTER Kasten/SUV 04/11→								
 Bremskraftverstärker								
1.5 dCi 1.5 dCi 4x4 1.6 16V 1.6 16V 4x4 1.6 16V Hi-Flex	66 66 77 77 77	04/11→ 04/11→ 04/11→ 04/11→ 04/11→		→ 10/13; + ABS		03.7853-4602.4	300302	ATE Ø 9" pneumatisch
1.5 dCi 4x4	80	04/13→		08/13→; + ABS		03.7853-4602.4	300302	ATE Ø 9" pneumatisch
 Hauptbremszylinder								
1.2 TCe 125 4x4	92	10/13→		06/15→; + ABS / - ESP 06/15→; + ABS / + ESP		24.4152-0381.3 24.4152-0391.3	011032 011033	ATE Ø 22,2 ohne Bremsflüssigkeitsbehälter ATE Ø 22,2 ohne Bremsflüssigkeitsbehälter
1.5 dCi 1.5 dCi 4x4 1.6 16V 4x4	66 66 77	04/11→ 04/11→ 04/11→		→ 10/13; - ESP → 10/13; + ESP 11/13→; + ABS / - ESP 11/13→; + ABS / + ESP		03.2122-2031.3 03.2122-2261.3 24.4152-0381.3 24.4152-0391.3	010938 010964 011032 011033	ATE Ø 22,2 ATE Ø 22,2 ATE Ø 22,2 ohne Bremsflüssigkeitsbehälter ATE Ø 22,2 ohne Bremsflüssigkeitsbehälter
1.5 dCi 4x4	80	04/13→		08/13→; + ABS / - ESP 08/13→; + ABS / + ESP		03.2122-2031.3 03.2122-2261.3	010938 010964	ATE Ø 22,2 ATE Ø 22,2
1.6 16V 1.6 16V Hi-Flex	77 77	04/11→ 04/11→		→ 10/13; - ESP 11/13→; + ABS / - ESP		03.2122-2031.3 24.4152-0381.3	010938 011032	ATE Ø 22,2 ATE Ø 22,2 ohne Bremsflüssigkeitsbehälter
1.6 S Ce 115 1.6 S Ce 115 LPG	84 84	06/15→ 06/15→01/18		+ ABS / - ESP + ABS / + ESP		24.4152-0381.3 24.4152-0391.3	011032 011033	ATE Ø 22,2 ohne Bremsflüssigkeitsbehälter ATE Ø 22,2 ohne Bremsflüssigkeitsbehälter
1.6 S Ce 115 4x4	84	06/15→01/18		für Linkslenker; + ABS / - ESP für Linkslenker; + ABS / + ESP		24.4152-0381.3 24.4152-0391.3	011032 011033	ATE Ø 22,2 ohne Bremsflüssigkeitsbehälter ATE Ø 22,2 ohne Bremsflüssigkeitsbehälter
DACIA - LODGY (JS_) 03/12→								
 Hauptbremszylinder								
1.2 TCe 1.3 TCe 100 1.3 TCe 130 1.5 Blue dCi 115 1.5 Blue dCi 95 1.5 dCi 1.6 →	85 75 96 85 70 63-81 61	03/12→ 01/19→ 01/19→ 08/18→ 08/18→ 03/12→ 03/12→ 03/12→		- ESP + ESP		24.4152-0381.3 24.4152-0391.3	011032 011033	ATE Ø 22,2 ohne Bremsflüssigkeitsbehälter ATE Ø 22,2 ohne Bremsflüssigkeitsbehälter















	kw					! #		
DACIA - LODGY (JS_) 03/12→								
 Hauptbremszylinder								
1.6 LPG	61 - 80	11/13→		- ESP		24.4152-0381.3	011032	ATE Ø 22,2 ohne Bremsflüssigkeitsbehälter
				+ ESP		24.4152-0391.3	011033	ATE Ø 22,2 ohne Bremsflüssigkeitsbehälter
1.6 SCe 100	75	06/15→		für Linkslenker; - ESP		24.4152-0381.3	011032	ATE Ø 22,2 ohne Bremsflüssigkeitsbehälter
				für Linkslenker; + ESP		24.4152-0391.3	011033	ATE Ø 22,2 ohne Bremsflüssigkeitsbehälter
DACIA - LOGAN (LS_) 08/04→								
 Bremskraftverstärker								
1.2 16V	55	02/06→		→ 04/13		03.7853-4602.4	300302	ATE Ø 9" pneumatisch
1.2 16V LPG	55	02/06→						
1.5 dCi	65	05/10→						
1.6 Bifuel	62	05/10→						
1.6 MPI 85	62	05/10→						
1.5 dCi	55	05/10→12/12				03.7853-4602.4	300302	ATE Ø 9" pneumatisch
1.5 dCi	63	09/07→12/11		+ ABS		03.7750-8532.4	300264	ATE Ø 9" pneumatisch
1.6	64	09/04→						
1.6 LPG	64	08/04→03/11						
1.6 16V Flexifuel	77	07/10→		01/11→ 04/13		03.7853-4602.4	300302	ATE Ø 9" pneumatisch
 Hauptbremszylinder								
1.2 16V	55	02/06→		+ ABS; → 04/13		03.2120-4611.3	010937	ATE Ø 20,6
1.2 16V LPG	55	02/06→		- ABS; → 04/13		24.2120-1762.3	011002	Ø 20,6 ohne Bremsflüssigkeitsbehälter
1.5 dCi	65	05/10→						
1.6 Bifuel	62	05/10→						
1.6 MPI 85	62	05/10→						
1.4	55	09/04→		→ 04/13; + ABS		24.2120-1754.3	010949	Ø 20,6
1.5 dCi	48	09/05→						
1.6 16V	77	02/06→		- ABS; → 04/13		24.2120-1762.3	011002	Ø 20,6 ohne Bremsflüssigkeitsbehälter
1.4 MPI LPG	55	02/06→12/12		+ ABS		24.2120-1754.3	010949	Ø 20,6
1.5 dCi	50	01/06→12/12		- ABS		24.2120-1762.3	011002	Ø 20,6 ohne Bremsflüssigkeitsbehälter
1.6	64	09/04→						
1.6 LPG	64	08/04→03/11						
1.5 dCi	55 - 63	09/07→12/12		+ ABS		03.2120-4611.3	010937	ATE Ø 20,6
				- ABS		24.2120-1762.3	011002	Ø 20,6 ohne Bremsflüssigkeitsbehälter
1.6 16V Flexifuel	77	07/10→		01/11→; + ABS; → 04/13		03.2120-4611.3	010937	ATE Ø 20,6
				01/11→; - ABS; → 04/13		24.2120-1762.3	011002	Ø 20,6 ohne Bremsflüssigkeitsbehälter
DACIA - LOGAN II 10/12→								
 Hauptbremszylinder								
1.0 LPG	74	11/19→		für Linkslenker		24.4120-1771.3	011076	Ø 20,6 ohne Bremsflüssigkeitsbehälter
1.0 SCe 75	54	01/17→						
1.0 TCe 100	74	11/19→						
1.6	59 - 63	06/13→						
1.2	54 - 55	10/12→		für Linkslenker; - ABS		24.4120-1714.3	011110	Ø 20,6 ohne Bremsflüssigkeitsbehälter
1.2 LPG	53 - 55	10/12→		für Linkslenker; + ABS		24.4120-1771.3	011076	Ø 20,6 ohne Bremsflüssigkeitsbehälter
1.5 Blue dCi 95	70	05/18→						
1.5 dCi	63 - 66	10/12→						
1.5 dCi / Blue dCi 75	55	10/12→						
1.6 16V	77	01/13→						
TCe 90	66	10/12→						
TCe 90 LPG	66	09/15→						
DACIA - LOGAN EXPRESS (FS_) 10/07→								
 Bremskraftverstärker								
1.4	55	03/09→		→ 06/13		03.7750-8532.4	300264	ATE Ø 9" pneumatisch
1.5 dCi	50 - 65	03/09→		+ ABS; → 06/13		03.7750-8532.4	300264	ATE Ø 9" pneumatisch
1.6 MPI 85	62	05/10→						
1.5 dCi	48	10/07→12/12		+ ABS		03.7750-8532.4	300264	ATE Ø 9" pneumatisch
1.6 LPG	62	05/10→12/12		+ ABS; → 01/11		03.7750-8532.4	300264	ATE Ø 9" pneumatisch
→				+ ABS; 02/11→		03.7853-4602.4	300302	ATE Ø 9" pneumatisch













	kw			 	! #		
DACIA - LOGAN EXPRESS (FS_) 10/07→							
 Hauptbremszylinder							
1.4	55	03/09→		+ ABS; → 06/13		03.2122-2031.3 010938	ATE Ø 22,2
				- ABS; → 06/13		24.2120-1762.3 011002	Ø 20,6 ohne Bremsflüssigkeitsbehälter
1.5 dCi	50 - 65	03/09→		+ ABS; → 06/13		03.2122-2031.3 010938	ATE Ø 22,2
1.6 MPI 85	62	05/10→					
1.5 dCi	48	10/07→12/12		+ ABS		03.2122-2031.3 010938	ATE Ø 22,2
1.6 LPG	62	05/10→12/12					
DACIA - LOGAN MCV (KS_) 02/07→							
 Bremskraftverstärker							
1.4	55	02/07→		→ 04/13; + ABS		03.7750-8532.4 300264	ATE Ø 9" pneumatisch
1.5 dCi	48 - 65	02/07→					
1.6	64	02/07→06/13					
1.6 16V	77	02/07→					
1.6 16V Hi-Flex	77	11/09→					
1.6 Bifuel	62 - 64	11/08→					
1.5 dCi	63	09/07→12/12		+ ABS		03.7750-8532.4 300264	ATE Ø 9" pneumatisch
1.6 MPI 85	62	05/10→		+ ABS		03.7853-4602.4 300302	ATE Ø 9" pneumatisch
 Hauptbremszylinder							
1.4	55	02/07→		- ABS; → 04/13		24.2120-1762.3 011002	Ø 20,6 ohne Bremsflüssigkeitsbehälter
1.5 dCi	48 - 50	02/07→					
1.6	64	02/07→06/13					
1.6 16V	77	02/07→					
1.5 dCi	55 - 65	05/10→		+ ABS; → 04/13		03.2122-2031.3 010938	ATE Ø 22,2
1.6 16V Hi-Flex	77	11/09→		- ABS; → 04/13		24.2120-1762.3 011002	Ø 20,6 ohne Bremsflüssigkeitsbehälter
1.5 dCi	63	09/07→12/12		+ ABS		03.2122-2031.3 010938	ATE Ø 22,2
				- ABS		24.2120-1762.3 011002	Ø 20,6 ohne Bremsflüssigkeitsbehälter
1.6 Bifuel	62 - 64	11/08→		+ ABS; → 04/13		24.2120-1754.3 010949	Ø 20,6
				- ABS; → 04/13		24.2120-1762.3 011002	Ø 20,6 ohne Bremsflüssigkeitsbehälter
1.6 MPI 85	62	05/10→		+ ABS; Bosnien-Herzegowina / Kroatien / + RO / + TR		03.2120-4611.3 010937	ATE Ø 20,6
				+ ABS		03.2122-2031.3 010938	ATE Ø 22,2
				- ABS; → 04/13		24.2120-1762.3 011002	Ø 20,6 ohne Bremsflüssigkeitsbehälter
DACIA - LOGAN MCV II 02/13→							
 Hauptbremszylinder							
1.0 LPG	74	11/19→		für Linkslenker		24.4120-1771.3 011076	Ø 20,6 ohne Bremsflüssigkeitsbehälter
1.0 TCe 100	74	11/19→					
1.0 SCe 75	54	12/16→		für Linkslenker; - ABS		24.4120-1714.3 011110	Ø 20,6 ohne Bremsflüssigkeitsbehälter
1.2	54 - 55	02/13→					
1.2 LPG	53 - 55	02/13→		für Linkslenker; + ABS		24.4120-1771.3 011076	Ø 20,6 ohne Bremsflüssigkeitsbehälter
1.5 Blue dCi 95	70	10/18→					
1.5 dCi	55 - 66	02/13→					
1.6	62	06/13→					
TCe 90	66	02/13→					
TCe 90 LPG	66	09/15→					
DACIA - LOGAN Pick-up (US_) 03/08→							
 Bremskraftverstärker							
1.4	55	01/09→		→ 06/13		03.7750-8532.4 300264	ATE Ø 9" pneumatisch
1.5 dCi	55 - 65	03/08→					
1.6	64	03/08→					
1.6 Bifuel	62	05/10→					
1.6 MPI 85	62	05/10→					
1.5 dCi	48	04/08→12/12		+ ABS		03.7750-8532.4 300264	ATE Ø 9" pneumatisch
1.6 16V	77	01/10→08/13					
1.5 dCi	50	03/08→		→ 06/13; + ABS		03.7750-8532.4 300264	ATE Ø 9" pneumatisch
→							









	kw					! #		
DACIA - LOGAN Pick-up (US_) 03/08→								
 Hauptbremszylinder								
1.4	55	01/09→		+ ABS; → 06/13		03.2122-2031.3	010938	ATE Ø 22,2
				- ABS; → 06/13		24.2120-1762.3	011002	Ø 20,6 ohne Bremsflüssigkeitsbehälter
1.5 dCi	50 - 65	03/08→		+ ABS; → 06/13		03.2122-2031.3	010938	ATE Ø 22,2
1.6	64	03/08→						
1.6 Bifuel	62	05/10→						
1.6 MPI 85	62	05/10→						
1.5 dCi	48	04/08→12/12		+ ABS		03.2122-2031.3	010938	ATE Ø 22,2
1.6 16V	77	01/10→08/13						
DACIA - SANDERO 06/08→								
 Bremskraftverstärker								
1.2 16V	55	11/08→		→ 02/13; + ABS		03.7853-4602.4	300302	ATE Ø 9" pneumatisch
1.2 16V LPG	55	11/08→						
1.4	55	06/08→						
1.4 MPI LPG	53	01/09→						
1.5 dCi	48 - 65	11/08→						
1.6 16V	77	07/11→						
1.6 MPI 85	62	05/10→06/13						
1.5 dCi	63	11/08→		→ 02/13		03.7750-8532.4	300264	ATE Ø 9" pneumatisch
1.6	64	06/08→		+ ABS		03.7853-4602.4	300302	ATE Ø 9" pneumatisch
1.6 16V Bifuel	77	01/11→						
1.6 Hi-Flex	64	06/08→12/12						
1.6 LPG	62 - 64	06/08→12/12						
1.6 LPG	60	01/11→12/12		→ 10/12; + ABS		03.7853-4602.4	300302	ATE Ø 9" pneumatisch
 Hauptbremszylinder								
1.2 16V	55	11/08→		→ 02/13; + ABS		03.2120-4611.3	010937	ATE Ø 20,6
1.2 16V LPG	55	11/08→						
1.4	55	06/08→		→ 02/13; - ABS		24.2120-1762.3	011002	Ø 20,6 ohne Bremsflüssigkeitsbehälter
1.4 MPI LPG	53	01/09→						
1.5 dCi	48 - 65	11/08→						
1.6 16V	77	07/11→						
1.6 MPI 85	62	05/10→06/13						
1.5 dCi	63	11/08→		→ 02/13; + ABS		03.2122-2031.3	010938	ATE Ø 22,2
1.6	64	06/08→		+ ABS		03.2120-4611.3	010937	ATE Ø 20,6
1.6 16V Bifuel	77	01/11→						
1.6 Hi-Flex	64	06/08→12/12		- ABS		24.2120-1762.3	011002	Ø 20,6 ohne Bremsflüssigkeitsbehälter
1.6 LPG	62 - 64	06/08→12/12						
1.6 LPG	60	01/11→12/12		→ 10/12; + ABS		03.2120-4611.3	010937	ATE Ø 20,6
				→ 10/12; - ABS		24.2120-1762.3	011002	Ø 20,6 ohne Bremsflüssigkeitsbehälter
DACIA - SANDERO II 10/12→								
 Hauptbremszylinder								
1.0 LPG	74	11/19→		für Linkslenker; + ABS		24.4120-1771.3	011076	Ø 20,6 ohne Bremsflüssigkeitsbehälter
1.0 TCe 100	74	11/19→						
1.0 SCe 75	54	12/16→		für Linkslenker; - ABS		24.4120-1714.3	011110	Ø 20,6 ohne Bremsflüssigkeitsbehälter
1.2	54	05/15→						
1.5 Blue dCi 95	70	08/18→						
1.5 dCi	63	01/13→		für Linkslenker; + ABS		24.4120-1771.3	011076	Ø 20,6 ohne Bremsflüssigkeitsbehälter
1.5 dCi 75 / Blue dCi 75	55	10/12→						
1.6	63	11/12→						
TCe 90 LPG	66	09/15→						
1.2	55	10/12→		11/12→; für Linkslenker; - ABS		24.4120-1714.3	011110	Ø 20,6 ohne Bremsflüssigkeitsbehälter
1.2 LPG	55	10/12→						
1.5 dCi	66	10/12→		für Linkslenker; + ABS		24.4120-1771.3	011076	Ø 20,6 ohne Bremsflüssigkeitsbehälter
TCe 90	66	10/12→						
DAEWOO - MATIZ (M100, M150) 09/98→								
 Hauptbremszylinder								
1.0	46	04/03→12/04		für Linkslenker; + ABS		24.2120-1755.3	010974	Ø 20,6 ohne Bremsflüssigkeitsbehälter
				für Linkslenker; - ABS		24.2120-1765.3	011003	Ø 20,6 ohne Bremsflüssigkeitsbehälter
1.0	47	01/03→		→ 02/05; für Linkslenker; + ABS		24.2120-1755.3	010974	Ø 20,6 ohne Bremsflüssigkeitsbehälter
				→ 02/05; für Linkslenker; - ABS		24.2120-1765.3	011003	Ø 20,6 ohne Bremsflüssigkeitsbehälter











	kw					! #		
DAEWOO - MATIZ (M200, M250) 01/05→12/18								
 Hauptbremszylinder								
0.8 1.0	38 49	01/05→06/10 03/05→12/08		für Linkslenker; + ABS		24.2120-1755.3	010974	Ø 20,6 ohne Bremsflüssigkeitsbehälter
				für Linkslenker; - ABS		24.2120-1765.3	011003	Ø 20,6 ohne Bremsflüssigkeitsbehälter
DAEWOO - MATIZ (M300) 01/10→11/12								
 Hauptbremszylinder								
1.0	51	01/10→11/12		für Linkslenker; + ABS		24.2120-1755.3	010974	Ø 20,6 ohne Bremsflüssigkeitsbehälter
				für Linkslenker; - ABS		24.2120-1765.3	011003	Ø 20,6 ohne Bremsflüssigkeitsbehälter
DAEWOO - MATIZ Kasten/Schrägheck (KLA4) 08/98→08/02								
 Hauptbremszylinder								
0.8	38	08/98→08/02		für Linkslenker; + ABS		24.2120-1755.3	010974	Ø 20,6 ohne Bremsflüssigkeitsbehälter
				für Linkslenker; - ABS		24.2120-1765.3	011003	Ø 20,6 ohne Bremsflüssigkeitsbehälter
DAIHATSU - CHARADE VIII 05/11→								
 Bremskraftverstärker								
1.33 16V	73	05/11→		→ 01/13; für Linkslenker; + ESP		03.7750-7132.4	300255	ATE Ø 9" pneumatisch
 Hauptbremszylinder								
1.33 16V	73	05/11→		→ 01/13; für Linkslenker; - ESP		03.4152-0153.3	011006	ATE Ø 22,2 ohne Bremsflüssigkeitsbehälter
				→ 01/13; für Linkslenker; + ESP		03.4152-0158.3	011007	ATE Ø 22,2 ohne Bremsflüssigkeitsbehälter
DS - DS 3 (SA_) 04/15→07/19								
 Hauptbremszylinder								
1.2 THP 110 / PureTech 110 1.2 THP 130 1.2 VTi 82 1.4 HDi 70 1.6 BlueHDi 100 1.6 BlueHDi 116 1.6 BlueHDi 120 1.6 BlueHDi 75 1.6 THP 1.6 THP 165 1.6 THP 208	81 96 60 50 73 85 88 55 110 - 120 121 153	04/15→07/19 09/15→07/19 04/15→07/19 07/15→12/16 04/15→07/19 07/15→07/19 07/15→07/19 07/15→07/19 07/15→07/19 07/15→07/19 07/15→07/19 09/15→07/19				24.4123-1734.3	011130	Ø 23,8 ohne Bremsflüssigkeitsbehälter
DS - DS 3 Cabriolet (SB_) 07/15→07/19								
 Hauptbremszylinder								
1.2 THP 110 1.2 THP 130 1.2 VTi 82 1.6 BlueHDi 100 1.6 BlueHDi 116 1.6 BlueHDi 120 1.6 THP 1.6 THP 165 1.6 THP 208	81 96 60 73 85 88 110 - 120 121 153	07/15→07/19 09/15→07/19 07/15→07/19 07/15→07/19 07/15→07/19 07/15→07/19 07/15→07/19 07/15→07/19 09/15→07/19				24.4123-1734.3	011130	Ø 23,8 ohne Bremsflüssigkeitsbehälter
DS - DS 4 / DS 4 CROSSBACK (NX_) 07/15→12/18								
 Hauptbremszylinder								
1.2 THP 130 1.6 BlueHDi 100 1.6 BlueHDi 115 1.6 BlueHDi 120 1.6 THP 150 1.6 THP 165 2.0 BlueHDi 150 2.0 BlueHDi 180 1.6 THP 160	96 73 85 88 110 121 110 133 120	07/15→12/18 04/16→12/18 07/15→12/18 07/15→12/18 10/16→12/18 07/15→12/18 07/15→12/18 07/15→12/18 07/15→12/18		+ ESP - ESP + ESP		24.4123-1726.3 24.4123-1739.3 24.4123-1726.3	011099 011150 011099	Ø 23,8 ohne Bremsflüssigkeitsbehälter BOS Ø 23,8 ohne Bremsflüssigkeitsbehälter Ø 23,8 ohne Bremsflüssigkeitsbehälter

	kw					! #		
DS - DS 5 (KF_) 01/15→12/18								
 Bremskraftverstärker								
1.6 BlueHDi 115	85	06/15→12/18			für Fahrzeuge mit Start-Stopp-Funktion		03.7860-3734.4 300317	ATE Ø 10" pneumatisch
1.6 BlueHDi 120	88	06/15→12/18						
1.6 THP 165	121	07/15→12/18						
1.6 THP 210	155	04/15→12/18						
2.0 BlueHDi 135	100	06/15→12/18						
2.0 BlueHDi 150	110	04/15→12/18						
2.0 BlueHDi 180	133	04/15→12/18						
Hybrid4	147	04/15→12/18					03.7860-3734.4 300317	ATE Ø 10" pneumatisch
 Hauptbremszylinder								
1.6 BlueHDi 115	85	06/15→12/18			82 mm Radnabendurchmesser [mm]		03.4153-0173.3 010815	ATE Ø 23,8
1.6 BlueHDi 120	88	06/15→12/18						
1.6 THP 165	121	07/15→12/18			83 mm Radnabendurchmesser [mm]		24.4155-1236.3 011049	ATE Ø 25,4 ohne Bremsflüssigkeitsbehälter
1.6 THP 210	155	04/15→12/18						
2.0 BlueHDi 135	100	06/15→12/18						
2.0 BlueHDi 150	110	04/15→12/18						
2.0 BlueHDi 180	133	04/15→12/18						
Hybrid4	147	04/15→12/18						
FIAT - 500 (312_) 07/07→								
 Hauptbremszylinder								
0.9	44 - 63	07/10→					24.4122-1714.3 010914	TRW Ø 22,2 ohne Bremsflüssigkeitsbehälter
1.3 D Multijet	57	06/16→						
1.4	74 - 75	10/07→						
1.4 Turbo	101	09/13→						
0.9 Electric	77 - 83	10/13→			12/13→		24.4122-1714.3 010914	TRW Ø 22,2 ohne Bremsflüssigkeitsbehälter
1.2	51	07/07→					24.4120-1702.3 010913	TRW Ø 20,6 ohne Bremsflüssigkeitsbehälter
1.2 LPG	51	12/10→						
1.3 D Multijet	55 - 70	10/07→						
FIAT - 500 C (312_) 09/09→								
 Hauptbremszylinder								
0.9	44 - 77	09/09→					24.4122-1714.3 010914	TRW Ø 22,2 ohne Bremsflüssigkeitsbehälter
1.3 D Multijet	55 - 70	09/09→						
1.4	74 - 75	09/09→						
1.2	51	09/09→					24.4120-1702.3 010913	TRW Ø 20,6 ohne Bremsflüssigkeitsbehälter
FIAT - 500L (351_, 352_) 09/12→								
 Hauptbremszylinder								
0.9	77	09/12→			für Linkslenker; Schaltgetriebe, automatisch betätigt		24.4122-1734.3 011117	Ø 22,2 ohne Bremsflüssigkeitsbehälter
0.9 Natural Power	59 - 63	03/13→						
1.3 D Multijet	62 - 70	09/12→						
1.4	70	09/12→						
1.4 LPG	88	02/14→						
1.6 D Multijet	77 - 88	09/12→						
1.4	88 - 119	09/13→			01/14→; für Linkslenker; Schaltgetriebe, automatisch betätigt		24.4122-1734.3 011117	Ø 22,2 ohne Bremsflüssigkeitsbehälter
FIAT - BARCHETTA (183_) 03/95→05/05								
 Hauptbremszylinder								
1.8 16V	96	04/95→05/05			→ 10/04; GG		24.2122-1716.3 010485	Ø 22,2
 Bremskraftregler								
1.8 16V	96	04/95→05/05			+ ABS; → 10/04; 		24.6513-1705.3 320237	lastabhängig 2x
FIAT - BRAVA (182_) 10/95→06/03								
 Hauptbremszylinder								
1.2 16V 80	59	10/00→10/01			für Linkslenker; GG		24.2122-1716.3 010485	Ø 22,2
1.4	55	10/95→10/01						
1.6 16V	66 - 76	10/95→12/02						
1.8 GT 16V →	83	10/95→08/01						

	kw			 	! #		
FIAT - BRAVA (182_) 10/95→06/03							
 Hauptbremszylinder							
1.9 D 1.9 JTD 1.9 JTD 105	48 74 77	10/95→10/01 09/00→10/01 12/98→10/01		für Linkslenker; GG		24.2122-1716.3 010485	Ø 22,2
1.2 16V 80	60	12/98→12/02		→ 10/01; für Linkslenker; GG		24.2122-1716.3 010485	Ø 22,2
1.9 TD 100 S 1.9 TD 75 S	74 55	03/96→10/01 03/96→10/01		06/96→; für Linkslenker; GG		24.2122-1716.3 010485	Ø 22,2
FIAT - BRAVO I (182_) 10/95→10/01							
 Hauptbremszylinder							
1.2 16V 80 1.4 1.6 1.6 16V 1.8 GT 1.9 D 1.9 JTD 1.9 JTD 105 2.0 HGT 20V	59 - 60 55 - 59 76 66 - 10/95→10/01 76 83 48 74 77 113	12/98→10/01 10/95→10/01 09/00→10/01 10/95→10/01 10/95→10/01 10/95→10/01 09/00→10/01 12/98→10/01 07/98→10/01		für Linkslenker; GG		24.2122-1716.3 010485	Ø 22,2
1.9 TD 100 S 1.9 TD 75 S	74 55	03/96→10/01 03/96→10/01		06/96→; für Linkslenker; GG		24.2122-1716.3 010485	Ø 22,2
FIAT - BRAVO II (198_) 11/06→12/16							
 Hauptbremszylinder							
1.4 1.4 T-Jet	66 88 - 110	04/07→12/14 09/07→12/14		→ 12/07		24.2122-1777.3 011056	Ø 22,2 ohne Bremsflüssigkeitsbehälter
1.9 D Multijet	66 - 110	04/07→12/14		01/08→		24.4123-1710.3 010866	BOS Ø 23,8 ohne Bremsflüssigkeitsbehälter
1.4 16V 1.4 T-Jet 1.6 D Multijet 2.0 D Multijet	103 112 66 - 88 120 - 121	04/10→12/14 06/11→12/16 03/08→12/14 09/08→12/14				24.4123-1710.3 010866	BOS Ø 23,8 ohne Bremsflüssigkeitsbehälter
1.4 LPG	66	12/08→12/14		11/09→		24.4123-1710.3 010866	BOS Ø 23,8 ohne Bremsflüssigkeitsbehälter
1.6 D Multijet	77	09/07→12/14		03/08→		24.4123-1710.3 010866	BOS Ø 23,8 ohne Bremsflüssigkeitsbehälter
1.9 D Multijet	85	11/06→12/09		04/07→ 12/07		24.2122-1777.3 011056	Ø 22,2 ohne Bremsflüssigkeitsbehälter
				01/08→		24.4123-1710.3 010866	BOS Ø 23,8 ohne Bremsflüssigkeitsbehälter
FIAT - BRAVO Van (198_) 03/08→12/14							
 Hauptbremszylinder							
1.6 JTD Multijet	77	03/08→12/14				24.4123-1710.3 010866	BOS Ø 23,8 ohne Bremsflüssigkeitsbehälter
FIAT - COUPE (175_) 11/93→08/00							
 Hauptbremszylinder							
1.8 16V	96	03/96→08/00		07/96→; GG		24.2122-1716.3 010485	Ø 22,2
FIAT - CROMA (194_) 06/05→12/11							
 Hauptbremszylinder							
1.8 16V	103	12/05→12/11		01/06→; für Linkslenker; → 11/10; für Fahrzeuge mit elektronischer Fahrdynamikregelung		24.2125-1732.3 010827	TRW Ø 25,4
1.9 D Multijet 2.2 16V 2.4 D Multijet	85 - 110 108 147	06/05→12/11 06/05→12/10 06/05→12/11		für Linkslenker; → 11/10; für Fahrzeuge mit elektronischer Fahrdynamikregelung		24.2125-1732.3 010827	TRW Ø 25,4
1.9 D Multijet	100	12/05→10/07		für Linkslenker; für Fahrzeuge mit elektronischer Fahrdynamikregelung		24.2125-1732.3 010827	TRW Ø 25,4
FIAT - CROMA Kasten/Kombi (194_) 04/06→12/11							
 Hauptbremszylinder							
1.9 MJTD	88	04/06→12/11		für Linkslenker; → 11/10; für Fahrzeuge mit elektronischer Fahrdynamikregelung		24.2125-1732.3 010827	TRW Ø 25,4

	kW			 	! #		
FIAT - DOBLO Bus (263_) 11/09→							
 Hauptbremszylinder							
1.3 D Multijet	66 - 70	02/10→		für Rechtslenker; + ESP		24.4123-1731.3 011094	Ø 23,8 ohne Bremsflüssigkeitsbehälter
1.4	88	02/10→					
1.4 Natural Power	88	02/10→					
1.6 D Multijet	66 - 88	02/10→					
1.6 D Multijet	77	01/10→		02/10→; für Rechtslenker; + ESP		24.4123-1731.3 011094	Ø 23,8 ohne Bremsflüssigkeitsbehälter
2.0 D Multijet	99	01/10→					
FIAT - DOBLO Cargo (263_) 02/10→							
 Hauptbremszylinder							
1.3 D Multijet	55 - 70	02/10→		für Rechtslenker; + ESP		24.4123-1731.3 011094	Ø 23,8 ohne Bremsflüssigkeitsbehälter
1.4	88	02/10→					
1.4 Natural Power	88	06/10→					
1.6 D Multijet	66 - 88	02/10→					
2.0 D Multijet	99	02/10→					
FIAT - DOBLO Großraumlimousine (119_, 223_) 03/01→							
 Hauptbremszylinder							
1.2	48	03/01→		→ 09/05; - ABS		24.2122-1750.3 010740	Ø 22,2
1.6	68	09/02→					
1.6 16V	76	10/01→					
1.9 D	46	03/01→					
1.3 D Multijet	62	10/05→		→ 01/10; + ABS		24.4123-1710.3 010866	BOS Ø 23,8 ohne Bremsflüssigkeitsbehälter
1.9 D Multijet	88	10/05→					
1.3 JTD	55	05/05→		10/05→ 01/10; + ABS		24.4123-1710.3 010866	BOS Ø 23,8 ohne Bremsflüssigkeitsbehälter
1.3 JTD 16V	51	12/04→05/05		- ABS		24.2122-1750.3 010740	Ø 22,2
1.6 Natural Power	76	09/02→		→ 09/05; - ABS		24.2122-1750.3 010740	Ø 22,2
				→ 01/10; + ABS		24.4123-1710.3 010866	BOS Ø 23,8 ohne Bremsflüssigkeitsbehälter
1.6 Natural Power	68	11/05→07/09		+ ABS		24.4123-1710.3 010866	BOS Ø 23,8 ohne Bremsflüssigkeitsbehälter
1.9 JTD	74 - 77	10/01→		→ 09/05; - ABS		24.2122-1750.3 010740	Ø 22,2
				10/05→ 01/10; + ABS		24.4123-1710.3 010866	BOS Ø 23,8 ohne Bremsflüssigkeitsbehälter
FIAT - DOBLO Kasten/Großraumlimousine (223_) 11/00→							
 Hauptbremszylinder							
1.2	48	03/01→01/04		- ABS		24.2122-1750.3 010740	Ø 22,2
1.2 16V	59	11/01→01/06					
1.6 16V	78	11/01→08/03					
1.3 D Multijet	55	10/05→01/10		+ ABS		24.4123-1710.3 010866	BOS Ø 23,8 ohne Bremsflüssigkeitsbehälter
1.3 JTD 16V	51	05/04→12/06		→ 09/05; - ABS		24.2122-1750.3 010740	Ø 22,2
1.6 16V	76	10/01→					
1.6 Natural Power	68 - 76	09/02→					
1.9 D	46	03/01→					
1.3 JTD 16V Multijet	62	08/06→		→ 01/10; + ABS		24.4123-1710.3 010866	BOS Ø 23,8 ohne Bremsflüssigkeitsbehälter
1.9 JTD Multijet	88	12/06→					
1.9 JTD	74 - 77	10/01→		→ 09/05; - ABS		24.2122-1750.3 010740	Ø 22,2
				10/05→ 01/10; + ABS		24.4123-1710.3 010866	BOS Ø 23,8 ohne Bremsflüssigkeitsbehälter
FIAT - DOBLO Pritsche/Fahrgestell (263_) 02/10→							
 Hauptbremszylinder							
1.3 D Multijet	55 - 70	02/10→		für Rechtslenker; + ESP		24.4123-1731.3 011094	Ø 23,8 ohne Bremsflüssigkeitsbehälter
1.4	88	04/10→					
1.4 Natural Power	88	06/10→					
1.6 D Multijet	66 - 88	02/10→					
2.0 D Multijet	99	02/10→					

	kw			 	! #				
FIAT - DUCATO Bus (230_) 03/94→05/05									
 Hauptbremszylinder									
1.9 D	50	04/98→04/02		→ 10/01; Nutzlast [kg]: 1000; + ABS		24.2125-1702.3 010482	Ø 25,4		
1.9 D Combinato	51	06/95→04/02		→ 10/01; Nutzlast [kg]: 1000; - ABS		24.2125-1703.3 010483	Ø 25,4		
1.9 TD	66	04/98→04/02		11/01→ 03/02; Nutzlast [kg]: 1000; + ABS		24.2125-1726.3 010718	Ø 25,4		
1.9 D	59	05/98→11/01		→ 10/01; Nutzlast [kg]: 1000; + ABS		24.2125-1702.3 010482	Ø 25,4		
				→ 10/01; Nutzlast [kg]: 1000; - ABS		24.2125-1703.3 010483	Ø 25,4		
				11/01→; Nutzlast [kg]: 1000; + ABS		24.2125-1726.3 010718	Ø 25,4		
1.9 TD Combinato	59	08/94→04/02		→ 10/94; Nutzlast [kg]: 1000; - ABS		24.2122-1715.3 010481	Ø 22,2		
			60	03/94→04/02		11/94→ 10/01; Nutzlast [kg]: 1000; + ABS		24.2125-1702.3 010482	Ø 25,4
						11/94→ 10/01; Nutzlast [kg]: 1000; - ABS		24.2125-1703.3 010483	Ø 25,4
				11/01→ 03/02; Nutzlast [kg]: 1000; + ABS		24.2125-1726.3 010718	Ø 25,4		
2.0 4x4	80	11/94→11/01		→ 10/01; Nutzlast ab [kg] 1000 Nutzlast bis [kg] 1400; + ABS		24.2125-1702.3 010482	Ø 25,4		
				→ 10/01; Nutzlast [kg]: 1800; + ABS		24.2125-1702.3 010482	Ø 25,4		
				→ 10/01; Nutzlast ab [kg] 1000 Nutzlast bis [kg] 1400; - ABS		24.2125-1703.3 010483	Ø 25,4		
				→ 10/01; Nutzlast [kg]: 1800; - ABS		24.2125-1703.3 010483	Ø 25,4		
				11/01→; Nutzlast [kg]: 1800; + ABS		24.2125-1726.3 010718	Ø 25,4		
2.0 JTD	62	10/01→04/02		→ 03/02; Nutzlast [kg]: 1400; + ABS		24.2125-1726.3 010718	Ø 25,4		
				→ 03/02; Nutzlast [kg]: 1800; + ABS		24.2125-1726.3 010718	Ø 25,4		
				→ 10/94; Nutzlast ab [kg] 1000 Nutzlast bis [kg] 1400; - ABS		24.2122-1715.3 010481	Ø 22,2		
2.0 Panorama/Combinato	80	03/94→04/02		→ 10/01; Nutzlast [kg]: 1800; + ABS		24.2125-1702.3 010482	Ø 25,4		
				11/94→ 10/01; Nutzlast ab [kg] 1000 Nutzlast bis [kg] 1400; + ABS		24.2125-1702.3 010482	Ø 25,4		
				→ 10/01; Nutzlast [kg]: 1800; - ABS		24.2125-1703.3 010483	Ø 25,4		
				11/94→ 10/01; Nutzlast ab [kg] 1000 Nutzlast bis [kg] 1400; - ABS		24.2125-1703.3 010483	Ø 25,4		
				11/01→ 03/02; Nutzlast ab [kg] 1000 Nutzlast bis [kg] 1400; + ABS		24.2125-1726.3 010718	Ø 25,4		
				11/01→ 03/02; Nutzlast [kg]: 1800; + ABS		24.2125-1726.3 010718	Ø 25,4		
2.5 D Combinato	62	08/94→04/02		→ 10/94; Nutzlast [kg]: 1400; - ABS		24.2122-1715.3 010481	Ø 22,2		
			80 - 85	03/94→04/02		11/94→ 10/01; Nutzlast [kg]: 1400; + ABS		24.2125-1702.3 010482	Ø 25,4
						→ 10/01; Nutzlast [kg]: 1800; + ABS		24.2125-1702.3 010482	Ø 25,4
						11/94→ 10/01; Nutzlast [kg]: 1400; - ABS		24.2125-1703.3 010483	Ø 25,4
						→ 10/01; Nutzlast [kg]: 1800; - ABS		24.2125-1703.3 010483	Ø 25,4
						11/01→ 03/02; Nutzlast [kg]: 1400; + ABS		24.2125-1726.3 010718	Ø 25,4
	11/01→ 03/02; Nutzlast [kg]: 1800; + ABS		24.2125-1726.3 010718	Ø 25,4					
2.5 TDI 4x4	85	04/97→04/02		→ 10/01; Nutzlast [kg]: 1400; + ABS		24.2125-1702.3 010482	Ø 25,4		
				→ 10/01; Nutzlast [kg]: 1400; - ABS		24.2125-1703.3 010483	Ø 25,4		
				11/01→ 03/02; Nutzlast [kg]: 1400; + ABS		24.2125-1726.3 010718	Ø 25,4		
2.8 D	64	02/98→04/02		→ 10/01; Nutzlast [kg]: 1400; + ABS		24.2125-1702.3 010482	Ø 25,4		
			94	11/00→04/02		→ 10/01; Nutzlast [kg]: 1800; + ABS		24.2125-1702.3 010482	Ø 25,4
						→ 10/01; Nutzlast [kg]: 1400; - ABS		24.2125-1703.3 010483	Ø 25,4
						→ 10/01; Nutzlast [kg]: 1800; - ABS		24.2125-1703.3 010483	Ø 25,4
						11/01→ 03/02; Nutzlast [kg]: 1800; + ABS		24.2125-1726.3 010718	Ø 25,4
						11/01→ 03/02; Nutzlast [kg]: 1400; + ABS		24.2125-1726.3 010718	Ø 25,4
2.8 JTD	94	11/00→04/02		→ 10/01; Nutzlast [kg]: 1800; + ABS		24.2125-1702.3 010482	Ø 25,4		
				→ 10/01; Nutzlast [kg]: 1400; - ABS		24.2125-1703.3 010483	Ø 25,4		
2.8 JTD 4x4	94	11/00→04/02		→ 10/01; Nutzlast [kg]: 1400; - ABS		24.2125-1703.3 010483	Ø 25,4		
				→ 10/01; Nutzlast [kg]: 1800; - ABS		24.2125-1703.3 010483	Ø 25,4		
2.8 TDI	90	10/97→04/02		→ 10/01; Nutzlast [kg]: 1400; - ABS		24.2125-1703.3 010483	Ø 25,4		
				→ 10/01; Nutzlast [kg]: 1800; - ABS		24.2125-1703.3 010483	Ø 25,4		
2.8 TDI 4x4	90	07/99→04/02		→ 10/01; Nutzlast [kg]: 1800; + ABS		24.2125-1726.3 010718	Ø 25,4		
				→ 10/01; Nutzlast [kg]: 1400; + ABS		24.2125-1726.3 010718	Ø 25,4		
 Bremskraftregler									
1.9 D	50 - 59	04/98→04/02		→ 10/01; Nutzlast [kg]: 1000; - ABS		24.6512-1701.3 320153	lastabhängig 2x		
1.9 D Combinato	51	06/95→04/02							
1.9 TD	66	04/98→04/02							
1.9 TD Combinato	59	08/94→04/02							
1.9 TD Panorama/Combinato	60	03/94→04/02							
2.0 4x4	80	11/94→11/01		→ 10/01; Nutzlast ab [kg] 1000 Nutzlast bis [kg] 1800; - ABS		24.6512-1701.3 320153	lastabhängig 2x		
2.0 Panorama/Combinato	80	03/94→04/02							
→									

	kW			 	! #		
FIAT - DUCATO Bus (230_) 03/94→05/05							
 Bremskraftregler							
2.5 D Combinato	62	08/94→04/02		→ 10/01; Nutzlast ab [kg] 1400 Nutzlast bis [kg] 1800; - ABS		24.6512-1701.3 320153	lastabhängig 2x
2.5 TDI 4x4	85	04/97→04/02					
2.5 TDI Panorama/Combinato	80 - 85	03/94→04/02					
2.8 D	64	02/98→04/02					
2.8 JTD	94	11/00→04/02					
2.8 JTD 4x4	94	11/00→04/02					
2.8 TDI	90	10/97→04/02					
2.8 TDI 4x4	90	07/99→04/02					
FIAT - DUCATO Bus (244_) 12/01→							
 Hauptbremszylinder							
2.0	81	12/01→07/06		Nutzlast ab [kg] 1100 Nutzlast bis [kg] 1500; für Fahrzeuge mit elektronischer Fahrdynamikregelung		24.2125-1726.3 010718	Ø 25,4
2.0 4x4	81	05/02→07/06		1800; + ABS			
2.0 Bipower	81	11/02→07/06					
2.0 JTD	62	12/01→07/06					
2.0 LPG	71	11/02→07/06					
2.3 JTD	81 - 93	12/01→12/17					
2.8 JTD	107	04/04→07/06					
2.8 JTD 4x4	94	12/01→07/06					
2.8 TD	90	11/03→07/06					
2.8 TD 4x4	90	11/03→07/06					
2.8 JTD	94	12/01→		→ 07/06; Nutzlast ab [kg] 1100 Nutzlast bis [kg] 1800; + ABS		24.2125-1726.3 010718	Ø 25,4
FIAT - DUCATO Bus (250_) 07/06→							
 Hauptbremszylinder							
2 D 100 Multijet 2	74	07/06→05/11		Nutzlast ab [kg] 1100 Nutzlast bis [kg] 1500; für Fahrzeuge mit elektronischer Fahrdynamikregelung		24.4125-1701.3 010867	BOS Ø 25,4 ohne Bremsflüssigkeitsbehälter
	74	07/06→05/11		Nutzlast ab [kg] 1100 Nutzlast bis [kg] 1500; für Fahrzeuge ohne elektronische Fahrdynamikregelung		24.4125-1702.3 010872	BOS Ø 25,4 ohne Bremsflüssigkeitsbehälter
				+ ASR; nicht für Schaltgetriebe sequentiell		24.4125-1711.3 011111	Ø 25,4 ohne Bremsflüssigkeitsbehälter
				Nutzlast ab [kg] 1700 Nutzlast bis [kg] 2000; für Fahrzeuge mit elektronischer Fahrdynamikregelung; Nutzlast-Code: Nutzlast leicht / Nutzlast schwer		24.4126-1701.3 010868	BOS Ø 27 ohne Bremsflüssigkeitsbehälter
				Nutzlast ab [kg] 1700 Nutzlast bis [kg] 2000; für Fahrzeuge ohne elektronische Fahrdynamikregelung; Nutzlast-Code: Nutzlast leicht / Nutzlast schwer		24.4126-1702.3 010875	BOS Ø 27 ohne Bremsflüssigkeitsbehälter
3 D 110 Multijet 2	82	05/14→		Nutzlast ab [kg] 1100 Nutzlast bis [kg] 1500; für Fahrzeuge mit elektronischer Fahrdynamikregelung		24.4125-1701.3 010867	BOS Ø 25,4 ohne Bremsflüssigkeitsbehälter
	82	05/14→		Nutzlast ab [kg] 1100 Nutzlast bis [kg] 1500; für Fahrzeuge ohne elektronische Fahrdynamikregelung		24.4125-1702.3 010872	BOS Ø 25,4 ohne Bremsflüssigkeitsbehälter
				+ ASR; nicht für Schaltgetriebe sequentiell		24.4125-1711.3 011111	Ø 25,4 ohne Bremsflüssigkeitsbehälter
				- ASR; Nutzlast bis [kg] 3499; nicht für Schaltgetriebe sequentiell		24.4125-1712.3 011112	Ø 25,4 ohne Bremsflüssigkeitsbehälter
				- ASR; Schaltgetriebe sequentiell; Nutzlast bis [kg] 3499		24.4125-1715.3 011152	BOS Ø 25,4 ohne Bremsflüssigkeitsbehälter
				Nutzlast ab [kg] 1700 Nutzlast bis [kg] 2000; für Fahrzeuge mit elektronischer Fahrdynamikregelung; Nutzlast-Code: Nutzlast leicht / Nutzlast schwer		24.4126-1701.3 010868	BOS Ø 27 ohne Bremsflüssigkeitsbehälter
				Nutzlast ab [kg] 1700 Nutzlast bis [kg] 2000; für Fahrzeuge ohne elektronische Fahrdynamikregelung; Nutzlast-Code: Nutzlast leicht / Nutzlast schwer		24.4126-1702.3 010875	BOS Ø 27 ohne Bremsflüssigkeitsbehälter
3 D 110 Multijet 2 0 D	83 - 96	07/06→		Nutzlast ab [kg] 1100 Nutzlast bis [kg] 1500; für Fahrzeuge mit elektronischer Fahrdynamikregelung		24.4125-1701.3 010867	BOS Ø 25,4 ohne Bremsflüssigkeitsbehälter
	83	10/11→					
	85 - 130	07/06→		Nutzlast ab [kg] 1100 Nutzlast bis [kg] 1500; für Fahrzeuge ohne elektronische Fahrdynamikregelung		24.4125-1702.3 010872	BOS Ø 25,4 ohne Bremsflüssigkeitsbehälter
	85	06/11→					
	88	07/06→					
	96	01/07→		05/14→; + ASR; nicht für Schaltgetriebe sequentiell		24.4125-1711.3 011111	Ø 25,4 ohne Bremsflüssigkeitsbehälter
	96	06/11→					
	100	04/09→		05/14→; - ASR; Nutzlast bis [kg] 3499; nicht für Schaltgetriebe sequentiell		24.4125-1712.3 011112	Ø 25,4 ohne Bremsflüssigkeitsbehälter
	115 - 116	07/06→					
	116	07/06→		05/14→; - ASR; Schaltgetriebe sequentiell; Nutzlast bis [kg] 3499		24.4125-1715.3 011152	BOS Ø 25,4 ohne Bremsflüssigkeitsbehälter
	130	06/11→					
→							

FIAT - DUCATO Bus (250_) 07/06→









Hauptbremszylinder

3 D 110 Multijet 2 0 D	83 - 96	07/06→		Nutzlast ab [kg] 1700 Nutzlast bis [kg] 2000; für Fahrzeuge mit elektronischer Fahrdynamikregelung; Nutzlast-Code: Nutzlast leicht / Nutzlast schwer	24.4126-1701.3	010868	BOS Ø 27 ohne Bremsflüssigkeitsbehälter
115 Multijet 2 120 Multijet 2 130 Multijet 2 3 D 4x4 140 Natural Power 160 Multijet 3	83 85 - 130	10/11→ 07/06→		Nutzlast ab [kg] 1700 Nutzlast bis [kg] 2000; für Fahrzeuge ohne elektronische Fahrdynamikregelung; Nutzlast-Code: Nutzlast leicht / Nutzlast schwer	24.4126-1702.3	010875	BOS Ø 27 ohne Bremsflüssigkeitsbehälter
0 D 4x4 180 Multijet 3	116 130	07/06→ 06/11→					
2 D 140 Multijet 2 3 D	103 103 103 -	07/21→ 05/19→ 05/19→		+ ASR; nicht für Schaltgetriebe sequentiell	24.4125-1711.3	011111	Ø 25,4 ohne Bremsflüssigkeitsbehälter
160 Multijet 2 180 Multijet 2	130 118 130	05/19→ 05/19→		- ASR; Nutzlast bis [kg] 3499; nicht für Schaltgetriebe sequentiell	24.4125-1712.3	011112	Ø 25,4 ohne Bremsflüssigkeitsbehälter
				- ASR; Schaltgetriebe sequentiell; Nutzlast bis [kg] 3499	24.4125-1715.3	011152	BOS Ø 25,4 ohne Bremsflüssigkeitsbehälter
3 D 150 Multijet 2	109 109	06/11→ 06/11→		05/14→; + ASR; nicht für Schaltgetriebe sequentiell	24.4125-1711.3	011111	Ø 25,4 ohne Bremsflüssigkeitsbehälter
				05/14→; - ASR; Nutzlast bis [kg] 3499; nicht für Schaltgetriebe sequentiell	24.4125-1712.3	011112	Ø 25,4 ohne Bremsflüssigkeitsbehälter
				05/14→; - ASR; Schaltgetriebe sequentiell; Nutzlast bis [kg] 3499	24.4125-1715.3	011152	BOS Ø 25,4 ohne Bremsflüssigkeitsbehälter
				Nutzlast ab [kg] 1700 Nutzlast bis [kg] 2000; für Fahrzeuge mit elektronischer Fahrdynamikregelung; Nutzlast-Code: Nutzlast leicht / Nutzlast schwer	24.4126-1701.3	010868	BOS Ø 27 ohne Bremsflüssigkeitsbehälter
				Nutzlast ab [kg] 1700 Nutzlast bis [kg] 2000; für Fahrzeuge ohne elektronische Fahrdynamikregelung; Nutzlast-Code: Nutzlast leicht / Nutzlast schwer	24.4126-1702.3	010875	BOS Ø 27 ohne Bremsflüssigkeitsbehälter
3 D 150 Multijet 2 3 D 4x4	110 110 110	04/15→ 04/15→ 04/15→		12/15→; + ASR; nicht für Schaltgetriebe sequentiell	24.4125-1711.3	011111	Ø 25,4 ohne Bremsflüssigkeitsbehälter
				12/15→; - ASR; Nutzlast bis [kg] 3499; nicht für Schaltgetriebe sequentiell	24.4125-1712.3	011112	Ø 25,4 ohne Bremsflüssigkeitsbehälter
				12/15→; - ASR; Schaltgetriebe sequentiell; Nutzlast bis [kg] 3499	24.4125-1715.3	011152	BOS Ø 25,4 ohne Bremsflüssigkeitsbehälter
0 D 150 Multijet 3	107 107	04/10→ 04/10→		06/11→; Nutzlast ab [kg] 1100 Nutzlast bis [kg] 1500; für Fahrzeuge mit elektronischer Fahrdynamikregelung	24.4125-1701.3	010867	BOS Ø 25,4 ohne Bremsflüssigkeitsbehälter
				Nutzlast ab [kg] 1100 Nutzlast bis [kg] 1500; für Fahrzeuge mit elektronischer Fahrdynamikregelung	24.4125-1701.3	010867	BOS Ø 25,4 ohne Bremsflüssigkeitsbehälter
				06/11→; Nutzlast ab [kg] 1100 Nutzlast bis [kg] 1500; für Fahrzeuge ohne elektronische Fahrdynamikregelung	24.4125-1702.3	010872	BOS Ø 25,4 ohne Bremsflüssigkeitsbehälter
				Nutzlast ab [kg] 1100 Nutzlast bis [kg] 1500; für Fahrzeuge ohne elektronische Fahrdynamikregelung	24.4125-1702.3	010872	BOS Ø 25,4 ohne Bremsflüssigkeitsbehälter
				05/14→; + ASR; nicht für Schaltgetriebe sequentiell	24.4125-1711.3	011111	Ø 25,4 ohne Bremsflüssigkeitsbehälter
				05/14→; - ASR; Nutzlast bis [kg] 3499; nicht für Schaltgetriebe sequentiell	24.4125-1712.3	011112	Ø 25,4 ohne Bremsflüssigkeitsbehälter
				05/14→; - ASR; Schaltgetriebe sequentiell; Nutzlast bis [kg] 3499	24.4125-1715.3	011152	BOS Ø 25,4 ohne Bremsflüssigkeitsbehälter
				Nutzlast ab [kg] 1700 Nutzlast bis [kg] 2000; für Fahrzeuge mit elektronischer Fahrdynamikregelung; Nutzlast-Code: Nutzlast leicht / Nutzlast schwer	24.4126-1701.3	010868	BOS Ø 27 ohne Bremsflüssigkeitsbehälter
				Nutzlast ab [kg] 1700 Nutzlast bis [kg] 2000; für Fahrzeuge ohne elektronische Fahrdynamikregelung; Nutzlast-Code: Nutzlast leicht / Nutzlast schwer	24.4126-1702.3	010875	BOS Ø 27 ohne Bremsflüssigkeitsbehälter











FIAT - DUCATO Kasten (230_) 03/94→05/05









Hauptbremszylinder

1.9 D 1.9 TD	50 66	04/98→04/02 04/98→04/02		→ 10/01; Nutzlast [kg]: 1000; + ABS	24.2125-1702.3	010482	Ø 25,4
				→ 10/01; Nutzlast [kg]: 1000; - ABS	24.2125-1703.3	010483	Ø 25,4
				11/01→ 03/02; Nutzlast [kg]: 1000; + ABS	24.2125-1726.3	010718	Ø 25,4
1.9 D 1.9 TD →	51 60	03/94→04/02 03/94→04/02		→ 10/94; Nutzlast [kg]: 1000; - ABS	24.2122-1715.3	010481	Ø 22,2

	kw			 	! #		
FIAT - DUCATO Kasten (230_) 03/94→05/05							
 Hauptbremszylinder							
1.9 TD CAT	59	08/94→04/02		11/94→ 10/01; Nutzlast [kg]: 1000; + ABS	24.2125-1702.3	010482	Ø 25,4
				11/94→ 10/01; Nutzlast [kg]: 1000; - ABS	24.2125-1703.3	010483	Ø 25,4
				11/01→ 03/02; Nutzlast [kg]: 1000; + ABS	24.2125-1726.3	010718	Ø 25,4
1.9 TD	59	05/98→11/01		→ 10/01; Nutzlast [kg]: 1000; + ABS	24.2125-1702.3	010482	Ø 25,4
				→ 10/01; Nutzlast [kg]: 1000; - ABS	24.2125-1703.3	010483	Ø 25,4
				11/01→; Nutzlast [kg]: 1000; + ABS	24.2125-1726.3	010718	Ø 25,4
2.0	80	03/94→04/02		→ 10/94; Nutzlast ab [kg] 1000 Nutzlast bis [kg] 1400; - ABS	24.2122-1715.3	010481	Ø 22,2
				→ 10/01; Nutzlast [kg]: 1800; + ABS	24.2125-1702.3	010482	Ø 25,4
				11/94→ 10/01; Nutzlast ab [kg] 1000 Nutzlast bis [kg] 1400; + ABS	24.2125-1702.3	010482	Ø 25,4
				→ 10/01; Nutzlast [kg]: 1800; - ABS	24.2125-1703.3	010483	Ø 25,4
				11/94→ 10/01; Nutzlast ab [kg] 1000 Nutzlast bis [kg] 1400; - ABS	24.2125-1703.3	010483	Ø 25,4
				11/01→ 03/02; Nutzlast ab [kg] 1000 Nutzlast bis [kg] 1400; + ABS	24.2125-1726.3	010718	Ø 25,4
2.0 4x4	80	11/94→04/02		→ 10/01; Nutzlast ab [kg] 1000 Nutzlast bis [kg] 1400; + ABS	24.2125-1702.3	010482	Ø 25,4
				→ 10/01; Nutzlast [kg]: 1800; + ABS	24.2125-1702.3	010482	Ø 25,4
				→ 10/01; Nutzlast ab [kg] 1000 Nutzlast bis [kg] 1400; - ABS	24.2125-1703.3	010483	Ø 25,4
				→ 10/01; Nutzlast [kg]: 1800; - ABS	24.2125-1703.3	010483	Ø 25,4
				11/01→ 03/02; Nutzlast ab [kg] 1000 Nutzlast bis [kg] 1400; + ABS	24.2125-1726.3	010718	Ø 25,4
				11/01→ 03/02; Nutzlast [kg]: 1800; + ABS	24.2125-1726.3	010718	Ø 25,4
2.0 JTD	62	10/01→04/02		→ 03/02; Nutzlast [kg]: 1800; + ABS	24.2125-1726.3	010718	Ø 25,4
				→ 03/02; Nutzlast [kg]: 1400; + ABS	24.2125-1726.3	010718	Ø 25,4
2.5 D 2.5 D 4x4 2.5 TDI	62	03/94→04/02		→ 10/94; Nutzlast [kg]: 1400; - ABS	24.2122-1715.3	010481	Ø 22,2
	62	03/94→04/02		11/94→ 10/01; Nutzlast [kg]: 1400; + ABS	24.2125-1702.3	010482	Ø 25,4
	80 -	03/94→04/02		→ 10/01; Nutzlast [kg]: 1800; + ABS	24.2125-1702.3	010482	Ø 25,4
	85			11/94→ 10/01; Nutzlast [kg]: 1400; - ABS	24.2125-1703.3	010483	Ø 25,4
				→ 10/01; Nutzlast [kg]: 1800; - ABS	24.2125-1703.3	010483	Ø 25,4
				11/01→ 03/02; Nutzlast [kg]: 1400; + ABS	24.2125-1726.3	010718	Ø 25,4
2.5 TDI 4x4 2.8 D 2.8 D 4x4 2.8 JTD 2.8 JTD 4x4 2.8 TDI 2.8 TDI 4x4	85	05/98→04/02		→ 10/01; Nutzlast [kg]: 1400; + ABS	24.2125-1702.3	010482	Ø 25,4
	64	05/98→04/02		→ 10/01; Nutzlast [kg]: 1800; + ABS	24.2125-1702.3	010482	Ø 25,4
	64	08/98→04/02		→ 10/01; Nutzlast [kg]: 1400; - ABS	24.2125-1703.3	010483	Ø 25,4
	94	11/00→04/02		→ 10/01; Nutzlast [kg]: 1800; - ABS	24.2125-1703.3	010483	Ø 25,4
	94	11/00→04/02		11/01→ 03/02; Nutzlast [kg]: 1400; + ABS	24.2125-1726.3	010718	Ø 25,4
	90	10/97→04/02		11/01→ 03/02; Nutzlast [kg]: 1800; + ABS	24.2125-1726.3	010718	Ø 25,4
2.8 TD 4x4	90	05/98→09/01		Nutzlast ab [kg] 1400 Nutzlast bis [kg] 1800; + ABS	24.2125-1702.3	010482	Ø 25,4
				Nutzlast ab [kg] 1400 Nutzlast bis [kg] 1800; - ABS	24.2125-1703.3	010483	Ø 25,4
 Bremskraftregler							
1.9 D 1.9 TD 1.9 TD CAT	50 - 51	03/94→04/02		→ 10/01; Nutzlast [kg]: 1000; - ABS	24.6512-1701.3	320153	lastabhängig 2x
	59 - 66						
	59		08/94→04/02				
2.0 2.0 4x4	80	03/94→04/02		→ 10/01; Nutzlast ab [kg] 1000 Nutzlast bis [kg] 1800; - ABS	24.6512-1701.3	320153	lastabhängig 2x
	80	11/94→04/02					
2.5 D 2.5 D 4x4 2.5 TDI 2.5 TDI 4x4 2.8 D 2.8 D 4x4 2.8 JTD 2.8 JTD 4x4 →	62	03/94→04/02		→ 10/01; Nutzlast ab [kg] 1400 Nutzlast bis [kg] 1800; - ABS	24.6512-1701.3	320153	lastabhängig 2x
	62	03/94→04/02					
	80 -	03/94→04/02					
	85						
	85	05/98→04/02					
	64	05/98→04/02					
	64	08/98→04/02					
	94	11/00→04/02					
	94	11/00→04/02					



	kw					! #		
FIAT - DUCATO Kasten (230_) 03/94→05/05								
 Bremskraftregler								
2.8 TDI	90	10/97→04/02		→ 10/01; Nutzlast ab [kg] 1400 Nutzlast bis [kg] 1800; - ABS		24.6512-1701.3	320153	lastabhängig 2x
2.8 TDI 4x4	90	06/99→04/02						
2.8 TD 4x4	90	05/98→09/01		Nutzlast ab [kg] 1400 Nutzlast bis [kg] 1800; - ABS		24.6512-1701.3	320153	lastabhängig 2x
FIAT - DUCATO Kasten (244_) 12/01→								
 Hauptbremszylinder								
2.0	81	12/01→07/06		Nutzlast ab [kg] 1100 Nutzlast bis [kg] 1800; + ABS		24.2125-1726.3	010718	Ø 25,4
2.0 Bipower	81	11/02→07/06						
2.0 JTD	62	12/01→07/06						
2.0 LPG	71	11/02→07/06						
2.3 JTD	81 - 93	12/01→12/18						
2.8 JTD 4x4	94	12/01→07/06						
2.8 JTD Power	107	04/04→07/06						
2.8 TD	90	12/01→07/06						
2.8 JTD	94	12/01→12/11		→ 07/06; Nutzlast ab [kg] 1100 Nutzlast bis [kg] 1800; + ABS		24.2125-1726.3	010718	Ø 25,4
FIAT - DUCATO Kasten (250_) 07/06→								
 Hauptbremszylinder								
2 D	74	07/06→		Nutzlast ab [kg] 1100 Nutzlast bis [kg] 1500; für Fahrzeuge mit elektronischer Fahrdynamikregelung		24.4125-1701.3	010867	BOS Ø 25,4 ohne Bremsflüssigkeitsbehälter
100 Multijet 2	74	07/06→						
3 D	83 - 88	07/06→						
110 Multijet 2	83	10/11→		Nutzlast ab [kg] 1100 Nutzlast bis [kg] 1500; für Fahrzeuge ohne elektronische Fahrdynamikregelung		24.4125-1702.3	010872	BOS Ø 25,4 ohne Bremsflüssigkeitsbehälter
0 D	85 - 130	07/06→						
115 Multijet 2	85	06/11→		05/14→; + ASR; nicht für Schaltgetriebe sequentiell		24.4125-1711.3	011111	Ø 25,4 ohne Bremsflüssigkeitsbehälter
120 Multijet 2	88	07/06→						
3 D 4x4	88 - 96	03/10→		05/14→; - ASR; Nutzlast bis [kg] 3499; nicht für Schaltgetriebe sequentiell		24.4125-1712.3	011112	Ø 25,4 ohne Bremsflüssigkeitsbehälter
130 Multijet 2	96	06/11→						
140 Natural Power	100	04/09→		05/14→; - ASR; Schaltgetriebe sequentiell; Nutzlast bis [kg] 3499		24.4125-1715.3	011152	BOS Ø 25,4 ohne Bremsflüssigkeitsbehälter
160 Multijet 3	116	07/06→						
0 D 4x4	116	07/06→		Nutzlast ab [kg] 1700 Nutzlast bis [kg] 2000; für Fahrzeuge mit elektronischer Fahrdynamikregelung; Nutzlast-Code: Nutzlast leicht / Nutzlast schwer		24.4126-1701.3	010868	BOS Ø 27 ohne Bremsflüssigkeitsbehälter
180 Multijet 3	130	06/11→						
3 D	82 - 96	08/06→		12/15→; + ASR; nicht für Schaltgetriebe sequentiell		24.4125-1711.3	011111	Ø 25,4 ohne Bremsflüssigkeitsbehälter
110 Multijet 2	82	05/14→						
130 Multijet 2	96	08/06→		12/15→; - ASR; Nutzlast bis [kg] 3499; nicht für Schaltgetriebe sequentiell		24.4125-1712.3	011112	Ø 25,4 ohne Bremsflüssigkeitsbehälter
3 D 4x4	110	04/15→						
150 Multijet 2	110	04/15→		12/15→; - ASR; Schaltgetriebe sequentiell; Nutzlast bis [kg] 3499		24.4125-1715.3	011152	BOS Ø 25,4 ohne Bremsflüssigkeitsbehälter
120 Multijet 2	88 - 132	07/21→		+ ASR; nicht für Schaltgetriebe sequentiell		24.4125-1711.3	011111	Ø 25,4 ohne Bremsflüssigkeitsbehälter
2 D	88 - 103	07/21→						
140 Multijet 2	103	05/19→		- ASR; Nutzlast bis [kg] 3499; nicht für Schaltgetriebe sequentiell		24.4125-1712.3	011112	Ø 25,4 ohne Bremsflüssigkeitsbehälter
3 D	103 - 130	12/15→						
150 Multijet 2	110	12/15→		- ASR; Schaltgetriebe sequentiell; Nutzlast bis [kg] 3499		24.4125-1715.3	011152	BOS Ø 25,4 ohne Bremsflüssigkeitsbehälter
160 Multijet 2	118	05/19→						
180 Multijet 2	130 - 132	12/15→						
3 D	109	06/11→		05/14→; + ASR; nicht für Schaltgetriebe sequentiell		24.4125-1711.3	011111	Ø 25,4 ohne Bremsflüssigkeitsbehälter
150 Multijet 2	109	06/11→						
				05/14→; - ASR; Nutzlast bis [kg] 3499; nicht für Schaltgetriebe sequentiell		24.4125-1712.3	011112	Ø 25,4 ohne Bremsflüssigkeitsbehälter
				05/14→; - ASR; Schaltgetriebe sequentiell; Nutzlast bis [kg] 3499		24.4125-1715.3	011152	BOS Ø 25,4 ohne Bremsflüssigkeitsbehälter
				Nutzlast ab [kg] 1700 Nutzlast bis [kg] 2000; für Fahrzeuge mit elektronischer Fahrdynamikregelung; Nutzlast-Code: Nutzlast leicht / Nutzlast schwer		24.4126-1701.3	010868	BOS Ø 27 ohne Bremsflüssigkeitsbehälter
				Nutzlast ab [kg] 1700 Nutzlast bis [kg] 2000; für Fahrzeuge ohne elektronische Fahrdynamikregelung; Nutzlast-Code: Nutzlast leicht / Nutzlast schwer		24.4126-1702.3	010875	BOS Ø 27 ohne Bremsflüssigkeitsbehälter
0 D	107	04/10→		06/11→; Nutzlast ab [kg] 1100 Nutzlast bis [kg] 1500; für Fahrzeuge mit elektronischer Fahrdynamikregelung		24.4125-1701.3	010867	BOS Ø 25,4 ohne Bremsflüssigkeitsbehälter
150 Multijet 3	107	04/10→						
→								

	kw			 	! #		
FIAT - DUCATO Kasten (250_) 07/06→							
 Hauptbremszylinder							
0 D 150 Multijet 3	107 107	04/10→ 04/10→		Nutzlast ab [kg] 1100 Nutzlast bis [kg] 1500; für Fahrzeuge mit elektronischer Fahrdynamikregelung	24.4125-1701.3	010867	BOS Ø 25,4 ohne Bremsflüssigkeitsbehälter
				06/11→; Nutzlast ab [kg] 1100 Nutzlast bis [kg] 1500; für Fahrzeuge ohne elektronische Fahrdynamikregelung	24.4125-1702.3	010872	BOS Ø 25,4 ohne Bremsflüssigkeitsbehälter
				Nutzlast ab [kg] 1100 Nutzlast bis [kg] 1500; für Fahrzeuge ohne elektronische Fahrdynamikregelung	24.4125-1702.3	010872	BOS Ø 25,4 ohne Bremsflüssigkeitsbehälter
				05/14→; + ASR; nicht für Schaltgetriebe sequentiell	24.4125-1711.3	011111	Ø 25,4 ohne Bremsflüssigkeitsbehälter
				05/14→; - ASR; Nutzlast bis [kg] 3499; nicht für Schaltgetriebe sequentiell	24.4125-1712.3	011112	Ø 25,4 ohne Bremsflüssigkeitsbehälter
				05/14→; - ASR; Schaltgetriebe sequentiell; Nutzlast bis [kg] 3499	24.4125-1715.3	011152	BOS Ø 25,4 ohne Bremsflüssigkeitsbehälter
				Nutzlast ab [kg] 1700 Nutzlast bis [kg] 2000; für Fahrzeuge mit elektronischer Fahrdynamikregelung; Nutzlast-Code: Nutzlast leicht / Nutzlast schwer	24.4126-1701.3	010868	BOS Ø 27 ohne Bremsflüssigkeitsbehälter
0 D 160 Multijet 3	115 115	07/06→12/11 07/06→12/11		Nutzlast ab [kg] 1100 Nutzlast bis [kg] 1500; für Fahrzeuge mit elektronischer Fahrdynamikregelung	24.4125-1701.3	010867	BOS Ø 25,4 ohne Bremsflüssigkeitsbehälter
				Nutzlast ab [kg] 1100 Nutzlast bis [kg] 1500; für Fahrzeuge ohne elektronische Fahrdynamikregelung	24.4125-1702.3	010872	BOS Ø 25,4 ohne Bremsflüssigkeitsbehälter
				+ ASR; nicht für Schaltgetriebe sequentiell	24.4125-1711.3	011111	Ø 25,4 ohne Bremsflüssigkeitsbehälter
				Nutzlast ab [kg] 1700 Nutzlast bis [kg] 2000; für Fahrzeuge mit elektronischer Fahrdynamikregelung; Nutzlast-Code: Nutzlast leicht / Nutzlast schwer	24.4126-1701.3	010868	BOS Ø 27 ohne Bremsflüssigkeitsbehälter
				Nutzlast ab [kg] 1700 Nutzlast bis [kg] 2000; für Fahrzeuge ohne elektronische Fahrdynamikregelung; Nutzlast-Code: Nutzlast leicht / Nutzlast schwer	24.4126-1702.3	010875	BOS Ø 27 ohne Bremsflüssigkeitsbehälter
FIAT - DUCATO Pritsche/Fahrgestell (230_) 03/94→04/02							
 Hauptbremszylinder							
1.9 D 1.9 TD	50 66	04/98→04/02 04/98→04/02		→ 10/01; Nutzlast [kg]: 1000; + ABS	24.2125-1702.3	010482	Ø 25,4
				→ 10/01; Nutzlast [kg]: 1000; - ABS	24.2125-1703.3	010483	Ø 25,4
				11/01→ 03/02; Nutzlast [kg]: 1000; + ABS	24.2125-1726.3	010718	Ø 25,4
1.9 D 1.9 TD 1.9 TD CAT	51 60 59	03/94→04/02 03/94→04/02 08/94→04/02		→ 10/94; Nutzlast [kg]: 1000; - ABS	24.2122-1715.3	010481	Ø 22,2
				11/94→ 10/01; Nutzlast [kg]: 1000; + ABS	24.2125-1702.3	010482	Ø 25,4
				11/94→ 10/01; Nutzlast [kg]: 1000; - ABS	24.2125-1703.3	010483	Ø 25,4
				11/01→ 03/02; Nutzlast [kg]: 1000; + ABS	24.2125-1726.3	010718	Ø 25,4
1.9 TD	59	05/98→11/01		→ 10/01; Nutzlast [kg]: 1000; + ABS	24.2125-1702.3	010482	Ø 25,4
				→ 10/01; Nutzlast [kg]: 1000; - ABS	24.2125-1703.3	010483	Ø 25,4
				11/01→; Nutzlast [kg]: 1000; + ABS	24.2125-1726.3	010718	Ø 25,4
2.0	80	03/94→04/02		→ 10/94; Nutzlast ab [kg] 1000 Nutzlast bis [kg] 1400; - ABS	24.2122-1715.3	010481	Ø 22,2
				→ 10/01; Nutzlast [kg]: 1800; + ABS	24.2125-1702.3	010482	Ø 25,4
				11/94→ 10/01; Nutzlast ab [kg] 1000 Nutzlast bis [kg] 1400; + ABS	24.2125-1702.3	010482	Ø 25,4
				→ 10/01; Nutzlast [kg]: 1800; - ABS	24.2125-1703.3	010483	Ø 25,4
				11/94→ 10/01; Nutzlast ab [kg] 1000 Nutzlast bis [kg] 1400; - ABS	24.2125-1703.3	010483	Ø 25,4
				11/01→ 03/02; Nutzlast ab [kg] 1000 Nutzlast bis [kg] 1400; + ABS	24.2125-1726.3	010718	Ø 25,4
				11/01→ 03/02; Nutzlast [kg]: 1800; + ABS	24.2125-1726.3	010718	Ø 25,4
2.0 JTD	62	07/01→04/02		10/01→ 03/02; Nutzlast [kg]: 1400; + ABS	24.2125-1726.3	010718	Ø 25,4
				10/01→ 03/02; Nutzlast [kg]: 1800; + ABS	24.2125-1726.3	010718	Ø 25,4
2.5 D 2.5 D 4x4 →	62 62	03/94→04/02 03/94→04/02		→ 10/94; Nutzlast [kg]: 1400; - ABS	24.2122-1715.3	010481	Ø 22,2

FIAT - DUCATO Pritsche/Fahrgestell (230_) 03/94→04/02

Hauptbremszylinder

2.5 TDI	80	03/94→04/02	→ 11/94→ 10/01; Nutzlast [kg]: 1400; + ABS	24.2125-1702.3	010482	Ø 25,4
			→ 10/01; Nutzlast [kg]: 1800; + ABS			
			→ 11/94→ 10/01; Nutzlast [kg]: 1400; - ABS			
			→ 10/01; Nutzlast [kg]: 1800; - ABS			
			→ 11/01→ 03/02; Nutzlast [kg]: 1800; + ABS			
→ 11/01→ 03/02; Nutzlast [kg]: 1400; + ABS	24.2125-1726.3	010718	Ø 25,4			
2.5 TDI 4x4	85	06/98→04/02	→ 10/01; Nutzlast [kg]: 1400; + ABS	24.2125-1702.3	010482	Ø 25,4
2.8 D	64	02/98→04/02	→ 10/01; Nutzlast [kg]: 1800; + ABS	24.2125-1702.3	010482	Ø 25,4
2.8 JTD	94	11/00→04/02	→ 10/01; Nutzlast [kg]: 1400; - ABS	24.2125-1703.3	010483	Ø 25,4
2.8 JTD 4x4	94	10/01→04/02	→ 10/01; Nutzlast [kg]: 1400; - ABS	24.2125-1703.3	010483	Ø 25,4
2.8 TDI	90	12/98→04/02	→ 10/01; Nutzlast [kg]: 1800; - ABS	24.2125-1703.3	010483	Ø 25,4
			→ 11/01→ 03/02; Nutzlast [kg]: 1400; + ABS	24.2125-1726.3	010718	Ø 25,4
			→ 11/01→ 03/02; Nutzlast [kg]: 1800; + ABS	24.2125-1726.3	010718	Ø 25,4
2.8 iDTD 4x4	90	05/98→09/01	Nutzlast ab [kg] 1400 Nutzlast bis [kg] 1800; + ABS	24.2125-1702.3	010482	Ø 25,4
			Nutzlast ab [kg] 1400 Nutzlast bis [kg] 1800; - ABS	24.2125-1703.3	010483	Ø 25,4
2.8 TD 4x4	64	05/98→11/01	→ 09/01; Nutzlast ab [kg] 1400 Nutzlast bis [kg] 1800; + ABS	24.2125-1702.3	010482	Ø 25,4
			→ 09/01; Nutzlast ab [kg] 1400 Nutzlast bis [kg] 1800; - ABS	24.2125-1703.3	010483	Ø 25,4

Bremskraftregler

1.9 D	50 - 51	03/94→04/02	→ 10/01; Nutzlast [kg]: 1000; - ABS	24.6512-1701.3	320153	lastabhängig 2x
1.9 TD	59 - 66	03/94→04/02				
1.9 TD CAT	59	08/94→04/02				
2.0	80	03/94→04/02	→ 10/01; Nutzlast ab [kg] 1000 Nutzlast bis [kg] 1800; - ABS	24.6512-1701.3	320153	lastabhängig 2x
2.5 D	62	03/94→04/02	→ 10/01; Nutzlast ab [kg] 1400 Nutzlast bis [kg] 1800; - ABS	24.6512-1701.3	320153	lastabhängig 2x
2.5 D 4x4	62	03/94→04/02				
2.5 TDI	80	03/94→04/02				
2.5 TDI 4x4	85	06/98→04/02				
2.8 D	64	02/98→04/02				
2.8 JTD	94	11/00→04/02				
2.8 JTD 4x4	94	10/01→04/02				
2.8 TDI	90	12/98→04/02				
2.8 iDTD 4x4	90	05/98→09/01	Nutzlast ab [kg] 1400 Nutzlast bis [kg] 1800; - ABS	24.6512-1701.3	320153	lastabhängig 2x
2.8 TD 4x4	64	05/98→11/01	→ 09/01; Nutzlast ab [kg] 1400 Nutzlast bis [kg] 1800; - ABS	24.6512-1701.3	320153	lastabhängig 2x

FIAT - DUCATO Pritsche/Fahrgestell (244_) 12/01→









Hauptbremszylinder













2.0	81	04/02→07/06	Nutzlast ab [kg] 1100 Nutzlast bis [kg] 1800; + ABS	24.2125-1726.3	010718	Ø 25,4
2.0 JTD	62	12/01→07/06				
2.3 JTD	81	12/01→07/06				
2.8 JTD	90 - 94	12/01→07/06				
2.8 JTD 4x4	94	12/01→07/06				
2.8 JTD Power	107	04/04→07/06				

FIAT - DUCATO Pritsche/Fahrgestell (250_) 07/06→

Hauptbremszylinder

2 D	74	07/06→	Nutzlast ab [kg] 1100 Nutzlast bis [kg] 1500; für Fahrzeuge mit elektronischer Fahrdynamikregelung	24.4125-1701.3	010867	BOS Ø 25,4 ohne Bremsflüssigkeitsbehälter
100 Multijet 2	74	07/06→				
3 D	82 - 88	07/06→				
110 Multijet 2	82 - 83	08/06→	Nutzlast ab [kg] 1100 Nutzlast bis [kg] 1500; für Fahrzeuge ohne elektronische Fahrdynamikregelung	24.4125-1702.3	010872	BOS Ø 25,4 ohne Bremsflüssigkeitsbehälter
0 D	85 - 130	07/06→	05/14→; + ASR; nicht für Schaltgetriebe sequentiell	24.4125-1711.3	011111	Ø 25,4 ohne Bremsflüssigkeitsbehälter
115 Multijet 2	85	06/11→				
120 Multijet 2	88	07/06→	05/14→; - ASR; Nutzlast bis [kg] 3499; nicht für Schaltgetriebe sequentiell	24.4125-1712.3	011112	Ø 25,4 ohne Bremsflüssigkeitsbehälter
3 D 4x4	88	03/10→				
140 Natural Power	100	04/09→	05/14→; - ASR; Schaltgetriebe sequentiell; Nutzlast bis [kg] 3499	24.4125-1715.3	011152	BOS Ø 25,4 ohne Bremsflüssigkeitsbehälter
160 Multijet 3	116	07/06→				
180 Multijet 3	130	06/11→	Nutzlast ab [kg] 1700 Nutzlast bis [kg] 2000; für Fahrzeuge mit elektron-	24.4126-1701.3	010868	BOS Ø 27 ohne Bremsflüssigkeitsbehälter

	kw					! #		
FIAT - DUCATO Pritsche/Fahrgestell (250_) 07/06→								
 Hauptbremszylinder								
2 D 100 Multijet 2 3 D	74 74 82 - 88	07/06→ 07/06→ 07/06→		ischer Fahrdynamikregelung; Nutzlast-Code: Nutzlast leicht / Nutzlast schwer				
110 Multijet 2 0 D	82 - 83 85 - 130	08/06→ 07/06→		Nutzlast ab [kg] 1700 Nutzlast bis [kg] 2000; für Fahrzeuge ohne elektronische Fahrdynamikregelung; Nutzlast-Code: Nutzlast leicht / Nutzlast schwer		24.4126-1702.3	010875	BOS Ø 27 ohne Bremsflüssigkeitsbehälter
115 Multijet 2 120 Multijet 2 3 D 4x4 140 Natural Power 160 Multijet 3 180 Multijet 3	85 88 88 100 116 130	06/11→ 07/06→ 03/10→ 04/09→ 07/06→ 06/11→						
120 Multijet 2 2 D	88 88 - 132	09/21→ 09/21→		+ ASR; nicht für Schaltgetriebe sequentiell		24.4125-1711.3	011111	Ø 25,4 ohne Bremsflüssigkeitsbehälter
140 Multijet 2 3 D	103 103 - 130	05/19→ 12/15→		- ASR; Nutzlast bis [kg] 3499; nicht für Schaltgetriebe sequentiell		24.4125-1712.3	011112	Ø 25,4 ohne Bremsflüssigkeitsbehälter
150 Multijet 2 160 Multijet 2 180 Multijet 2	110 118 130 - 132	12/15→ 05/19→ 12/15→		- ASR; Schaltgetriebe sequentiell; Nutzlast bis [kg] 3499		24.4125-1715.3	011152	BOS Ø 25,4 ohne Bremsflüssigkeitsbehälter
130 Multijet 2 3 D	96 96	08/06→ 08/06→		01/07→; Nutzlast ab [kg] 1100 Nutzlast bis [kg] 1500; für Fahrzeuge mit elektronischer Fahrdynamikregelung		24.4125-1701.3	010867	BOS Ø 25,4 ohne Bremsflüssigkeitsbehälter
				01/07→; Nutzlast ab [kg] 1100 Nutzlast bis [kg] 1500; für Fahrzeuge ohne elektronische Fahrdynamikregelung		24.4125-1702.3	010872	BOS Ø 25,4 ohne Bremsflüssigkeitsbehälter
				05/14→; + ASR; nicht für Schaltgetriebe sequentiell		24.4125-1711.3	011111	Ø 25,4 ohne Bremsflüssigkeitsbehälter
				05/14→; - ASR; Nutzlast bis [kg] 3499; nicht für Schaltgetriebe sequentiell		24.4125-1712.3	011112	Ø 25,4 ohne Bremsflüssigkeitsbehälter
				05/14→; - ASR; Schaltgetriebe sequentiell; Nutzlast bis [kg] 3499		24.4125-1715.3	011152	BOS Ø 25,4 ohne Bremsflüssigkeitsbehälter
				01/07→; Nutzlast ab [kg] 1700 Nutzlast bis [kg] 2000; für Fahrzeuge mit elektronischer Fahrdynamikregelung; Nutzlast-Code: Nutzlast leicht / Nutzlast schwer		24.4126-1701.3	010868	BOS Ø 27 ohne Bremsflüssigkeitsbehälter
				01/07→; Nutzlast ab [kg] 1700 Nutzlast bis [kg] 2000; für Fahrzeuge ohne elektronische Fahrdynamikregelung; Nutzlast-Code: Nutzlast leicht / Nutzlast schwer		24.4126-1702.3	010875	BOS Ø 27 ohne Bremsflüssigkeitsbehälter
3 D 150 Multijet 2	109 109	06/11→ 06/11→		05/14→; + ASR; nicht für Schaltgetriebe sequentiell		24.4125-1711.3	011111	Ø 25,4 ohne Bremsflüssigkeitsbehälter
				05/14→; - ASR; Nutzlast bis [kg] 3499; nicht für Schaltgetriebe sequentiell		24.4125-1712.3	011112	Ø 25,4 ohne Bremsflüssigkeitsbehälter
				05/14→; - ASR; Schaltgetriebe sequentiell; Nutzlast bis [kg] 3499		24.4125-1715.3	011152	BOS Ø 25,4 ohne Bremsflüssigkeitsbehälter
				Nutzlast ab [kg] 1700 Nutzlast bis [kg] 2000; für Fahrzeuge mit elektronischer Fahrdynamikregelung; Nutzlast-Code: Nutzlast leicht / Nutzlast schwer		24.4126-1701.3	010868	BOS Ø 27 ohne Bremsflüssigkeitsbehälter
				Nutzlast ab [kg] 1700 Nutzlast bis [kg] 2000; für Fahrzeuge ohne elektronische Fahrdynamikregelung; Nutzlast-Code: Nutzlast leicht / Nutzlast schwer		24.4126-1702.3	010875	BOS Ø 27 ohne Bremsflüssigkeitsbehälter
0 D 150 Multijet 3	107 107	04/10→ 04/10→		06/11→; Nutzlast ab [kg] 1100 Nutzlast bis [kg] 1500; für Fahrzeuge mit elektronischer Fahrdynamikregelung		24.4125-1701.3	010867	BOS Ø 25,4 ohne Bremsflüssigkeitsbehälter
				Nutzlast ab [kg] 1100 Nutzlast bis [kg] 1500; für Fahrzeuge mit elektronischer Fahrdynamikregelung		24.4125-1701.3	010867	BOS Ø 25,4 ohne Bremsflüssigkeitsbehälter
				06/11→; Nutzlast ab [kg] 1100 Nutzlast bis [kg] 1500; für Fahrzeuge ohne elektronische Fahrdynamikregelung		24.4125-1702.3	010872	BOS Ø 25,4 ohne Bremsflüssigkeitsbehälter
				Nutzlast ab [kg] 1100 Nutzlast bis [kg] 1500; für Fahrzeuge ohne elektronische Fahrdynamikregelung		24.4125-1702.3	010872	BOS Ø 25,4 ohne Bremsflüssigkeitsbehälter
				05/14→; + ASR; nicht für Schaltgetriebe sequentiell		24.4125-1711.3	011111	Ø 25,4 ohne Bremsflüssigkeitsbehälter
				05/14→; - ASR; Nutzlast bis [kg] 3499; nicht für Schaltgetriebe sequentiell		24.4125-1712.3	011112	Ø 25,4 ohne Bremsflüssigkeitsbehälter
				05/14→; - ASR; Schaltgetriebe sequentiell; Nutzlast bis [kg] 3499		24.4125-1715.3	011152	BOS Ø 25,4 ohne Bremsflüssigkeitsbehälter
→								

	kw					! #		
FIAT - DUCATO Pritsche/Fahrgestell (250_) 07/06→								
 Hauptbremszylinder								
0 D 150 Multijet 3	107 107	04/10→ 04/10→		Nutzlast ab [kg] 1700 Nutzlast bis [kg] 2000; für Fahrzeuge mit elektronischer Fahrdynamikregelung; Nutzlast-Code: Nutzlast leicht / Nutzlast schwer		24.4126-1701.3	010868	BOS Ø 27 ohne Bremsflüssigkeitsbehälter
				Nutzlast ab [kg] 1700 Nutzlast bis [kg] 2000; für Fahrzeuge ohne elektronische Fahrdynamikregelung; Nutzlast-Code: Nutzlast leicht / Nutzlast schwer		24.4126-1702.3	010875	BOS Ø 27 ohne Bremsflüssigkeitsbehälter
0 D 160 Multijet 3	115 115	07/06→12/11 07/06→12/11		Nutzlast ab [kg] 1100 Nutzlast bis [kg] 1500; für Fahrzeuge mit elektronischer Fahrdynamikregelung		24.4125-1701.3	010867	BOS Ø 25,4 ohne Bremsflüssigkeitsbehälter
				Nutzlast ab [kg] 1100 Nutzlast bis [kg] 1500; für Fahrzeuge ohne elektronische Fahrdynamikregelung		24.4125-1702.3	010872	BOS Ø 25,4 ohne Bremsflüssigkeitsbehälter
				+ ASR; nicht für Schaltgetriebe sequenziell		24.4125-1711.3	011111	Ø 25,4 ohne Bremsflüssigkeitsbehälter
				Nutzlast ab [kg] 1700 Nutzlast bis [kg] 2000; für Fahrzeuge mit elektronischer Fahrdynamikregelung; Nutzlast-Code: Nutzlast leicht / Nutzlast schwer		24.4126-1701.3	010868	BOS Ø 27 ohne Bremsflüssigkeitsbehälter
				Nutzlast ab [kg] 1700 Nutzlast bis [kg] 2000; für Fahrzeuge ohne elektronische Fahrdynamikregelung; Nutzlast-Code: Nutzlast leicht / Nutzlast schwer		24.4126-1702.3	010875	BOS Ø 27 ohne Bremsflüssigkeitsbehälter
FIAT - FIORINO Großraumlimousine (225_) 01/07→								
 Hauptbremszylinder								
1.3 JTD Multijet 1.4 1.4 CNG	55 - 70 54 - 57 51 - 57	11/07→ 11/07→ 06/08→		für Rechtslenker		24.4122-1727.3	011098	Ø 22,2 ohne Bremsflüssigkeitsbehälter
FIAT - FIORINO Kasten/Großraumlimousine (146_) 01/88→								
 Hauptbremszylinder								
1.7 TD	46	11/96→05/00		- ABS		24.2122-1781.3	011059	Ø 22,2 ohne Bremsflüssigkeitsbehälter
60 1.7 D	44	05/88→05/00		09/88→ 08/93		24.2120-0802.3	010363	ATE Ø 20,6
				09/93→; - ABS		24.2122-1781.3	011059	Ø 22,2 ohne Bremsflüssigkeitsbehälter
65 1.7 TD 70 i.e. 1.4 75 i.e. 1.6	46 49 55	01/97→05/01 05/94→05/01 10/93→05/01		→ 03/01; - ABS		24.2122-1781.3	011059	Ø 22,2 ohne Bremsflüssigkeitsbehälter
FIAT - FIORINO Kasten/Großraumlimousine (225_) 01/07→								
 Hauptbremszylinder								
1.3 D Multijet 1.4 1.4 Natural Power Ecargo	55 - 59 57 51 24	11/07→ 10/09→ 06/08→ 01/10→12/12		für Rechtslenker		24.4122-1727.3	011098	Ø 22,2 ohne Bremsflüssigkeitsbehälter
1.3 D Multijet	70	07/09→		07/10→; für Rechtslenker		24.4122-1727.3	011098	Ø 22,2 ohne Bremsflüssigkeitsbehälter
1.4	54	11/07→		09/08→; für Rechtslenker		24.4122-1727.3	011098	Ø 22,2 ohne Bremsflüssigkeitsbehälter
1.4 Natural Power	57	06/08→		10/09→; für Rechtslenker		24.4122-1727.3	011098	Ø 22,2 ohne Bremsflüssigkeitsbehälter
FIAT - FIORINO Pick up (146_) 01/88→05/01								
 Hauptbremszylinder								
1.4 1.6 1.7 TD	49 55 46	05/94→05/01 01/94→05/01 01/97→05/01		→ 03/01; - ABS		24.2122-1781.3	011059	Ø 22,2 ohne Bremsflüssigkeitsbehälter
FIAT - GRANDE PUNTO (199_) 06/05→								
 Hauptbremszylinder								
1.2 1.3 D Multijet	48 51 - 62	10/05→ 07/08→		→ 08/10; für Fahrzeuge mit elektronischer Fahrdynamikregelung		24.4122-1709.3	010871	BOS Ø 22,2 ohne Bremsflüssigkeitsbehälter
1.4 16V 1.4 LPG 1.4 Natural Power 1.4 T-Jet →	70 57 57 88	10/05→08/11 12/08→ 07/08→ 09/07→		09/10→ 01/11		24.4122-1709.3	010871	BOS Ø 22,2 ohne Bremsflüssigkeitsbehälter

FIAT - GRANDE PUNTO (199_) 06/05→

Hauptbremszylinder

1.6 D Multijet 1.9 D Multijet	88 88	07/08→ 10/05→		→ 08/10; für Fahrzeuge mit elektronischer Fahrdynamikregelung	24.4122-1709.3	010871	BOS Ø 22,2 ohne Bremsflüssigkeitsbehälter
				09/10→ 01/11	24.4122-1709.3	010871	BOS Ø 22,2 ohne Bremsflüssigkeitsbehälter
1.2	50 - 51	06/09→		→ 01/11	24.4122-1709.3	010871	BOS Ø 22,2 ohne Bremsflüssigkeitsbehälter
1.2 LPG	51	06/08→12/12		09/10→ 01/11	24.4122-1709.3	010871	BOS Ø 22,2 ohne Bremsflüssigkeitsbehälter
1.3 D Multijet 1.6	55 85	10/05→06/13 02/11→		für Fahrzeuge mit elektronischer Fahrdynamikregelung	24.4122-1709.3	010871	BOS Ø 22,2 ohne Bremsflüssigkeitsbehälter
					24.4122-1709.3	010871	BOS Ø 22,2 ohne Bremsflüssigkeitsbehälter
1.3 D Multijet	56	06/09→07/14		10/09→; für Linkslenker	24.4122-1709.3	010871	BOS Ø 22,2 ohne Bremsflüssigkeitsbehälter
				→ 08/10; für Fahrzeuge mit elektronischer Fahrdynamikregelung	24.4122-1709.3	010871	BOS Ø 22,2 ohne Bremsflüssigkeitsbehälter
				09/10→ 01/11	24.4122-1709.3	010871	BOS Ø 22,2 ohne Bremsflüssigkeitsbehälter
				10/09→; für Rechtslenker; + ESP	24.4122-1727.3	011098	Ø 22,2 ohne Bremsflüssigkeitsbehälter
				10/09→; für Rechtslenker; - ESP	24.4122-1739.3	011149	BOS Ø 22,2 ohne Bremsflüssigkeitsbehälter
1.3 D Multijet	66	10/05→12/10		→ 08/10; für Fahrzeuge mit elektronischer Fahrdynamikregelung	24.4122-1709.3	010871	BOS Ø 22,2 ohne Bremsflüssigkeitsbehälter
				09/10→	24.4122-1709.3	010871	BOS Ø 22,2 ohne Bremsflüssigkeitsbehälter
1.4	57	06/05→12/15		→ 08/10; für Fahrzeuge mit elektronischer Fahrdynamikregelung	24.4122-1709.3	010871	BOS Ø 22,2 ohne Bremsflüssigkeitsbehälter
1.4 1.4 16V 1.9 D Multijet	55 66 85	10/05→07/07 06/09→07/14 06/06→12/09		für Fahrzeuge mit elektronischer Fahrdynamikregelung	24.4122-1709.3	010871	BOS Ø 22,2 ohne Bremsflüssigkeitsbehälter
1.9 D Multijet	96	10/05→		02/06→ 08/10; für Fahrzeuge mit elektronischer Fahrdynamikregelung	24.4122-1709.3	010871	BOS Ø 22,2 ohne Bremsflüssigkeitsbehälter
				09/10→ 01/11	24.4122-1709.3	010871	BOS Ø 22,2 ohne Bremsflüssigkeitsbehälter

FIAT - GRANDE PUNTO Van (199_) 10/05→06/13













Hauptbremszylinder













1.3 JTD Multijet 1.4 LPG 1.4 Natural Power	55 57 57	02/06→06/13 03/09→12/12 03/09→12/12		→ 08/10; für Fahrzeuge mit elektronischer Fahrdynamikregelung	24.4122-1709.3	010871	BOS Ø 22,2 ohne Bremsflüssigkeitsbehälter
				09/10→ 01/11	24.4122-1709.3	010871	BOS Ø 22,2 ohne Bremsflüssigkeitsbehälter
1.3 JTD Multijet	66	02/06→08/10		für Fahrzeuge mit elektronischer Fahrdynamikregelung	24.4122-1709.3	010871	BOS Ø 22,2 ohne Bremsflüssigkeitsbehälter
1.4	57	02/06→06/13		→ 08/10; für Fahrzeuge mit elektronischer Fahrdynamikregelung	24.4122-1709.3	010871	BOS Ø 22,2 ohne Bremsflüssigkeitsbehälter











FIAT - IDEA (350_) 12/03→















Hauptbremszylinder

















1.2 16V 1.9 JTD	59 74	01/04→ 01/04→		→ 11/06; für Fahrzeuge ohne elektronische Fahrdynamikregelung	24.2123-1763.3	010842	Ø 23,8
				→ 02/08	24.4123-1708.3	010859	BOS Ø 23,8
1.3 D Multijet 1.4 16V	51 70	01/04→ 01/04→		→ 11/06; für Fahrzeuge ohne elektronische Fahrdynamikregelung	24.2123-1763.3	010842	Ø 23,8
				12/06→ 02/08	24.4123-1708.3	010859	BOS Ø 23,8
1.3 D Multijet	66	10/05→		11/05→ 11/06; für Fahrzeuge ohne elektronische Fahrdynamikregelung	24.2123-1763.3	010842	Ø 23,8
				12/06→ 02/08	24.4123-1708.3	010859	BOS Ø 23,8
1.3 D Multijet 1.4 LPG 1.6 D Multijet	70 57 88	05/08→12/12 03/09→ 05/08→		→ 09/10	24.4123-1708.3	010859	BOS Ø 23,8
				10/10→ 07/12	24.4123-1708.3	010859	BOS Ø 23,8
1.4	57	10/05→		11/05→ 11/06; für Fahrzeuge ohne elektronische Fahrdynamikregelung	24.2123-1763.3	010842	Ø 23,8
				11/05→ 02/08	24.4123-1708.3	010859	BOS Ø 23,8
1.4	66	12/03→		01/04→ 11/06; für Fahrzeuge ohne elektronische Fahrdynamikregelung	24.2123-1763.3	010842	Ø 23,8
				12/06→ 02/08	24.4123-1708.3	010859	BOS Ø 23,8
1.8	81	01/08→07/10			24.4123-1708.3	010859	BOS Ø 23,8

















	kw					! #		
FIAT - IDEA Van (350_) 12/03→								
 Hauptbremszylinder								
1.4 JTD Multijet	70 51 - 66	10/04→12/12 10/04→12/11		→ 11/06; für Fahrzeuge ohne elektronische Fahrdynamikregelung			24.2123-1763.3 010842	Ø 23,8
				12/06→			24.4123-1708.3 010859	BOS Ø 23,8
MJTD	74	10/04→12/10		→ 11/06; für Fahrzeuge ohne elektronische Fahrdynamikregelung			24.2123-1763.3 010842	Ø 23,8
				→ 12/06			24.4123-1708.3 010859	BOS Ø 23,8
FIAT - LINEA (323_, 110_) 10/06→								
 Hauptbremszylinder								
1.3 D Multijet	66	06/07→		07/07→ 05/11; für Fahrzeuge mit elektronischer Fahrdynamikregelung			24.4122-1709.3 010871	BOS Ø 22,2 ohne Bremsflüssigkeitsbehälter
1.3 JTD Multijet	63	10/06→						
1.4	57	06/07→						
1.3 D Multijet	70	09/09→		→ 05/11; für Fahrzeuge mit elektronischer Fahrdynamikregelung			24.4122-1709.3 010871	BOS Ø 22,2 ohne Bremsflüssigkeitsbehälter
1.4	66	12/08→						
1.4 T-Jet	84 - 88	05/07→						
1.6 D Multijet	77	06/09→						
1.6	81	10/11→		für Fahrzeuge mit elektronischer Fahrdynamikregelung			24.4122-1709.3 010871	BOS Ø 22,2 ohne Bremsflüssigkeitsbehälter
FIAT - MAREA (185_) 05/96→12/07								
 Hauptbremszylinder								
1.2 16V	60	10/98→05/02		04/99→; für Linkslenker; GG			24.2122-1716.3 010485	Ø 22,2
1.4 80 12V	59	09/96→05/02		für Linkslenker; GG			24.2122-1716.3 010485	Ø 22,2
1.6	68 - 78	03/99→12/07						
1.6 100 16V	76	09/96→05/02						
1.6 100 16V Bipower	76	04/99→05/02						
1.6 SX	72	09/00→08/02						
1.8 115 16V	83	09/96→05/02						
1.9 JTD 105	77	12/98→12/02						
1.9 JTD 110	81	09/00→08/02						
1.9 TD 100	74	05/96→12/02						
1.9 TD 75	55	09/96→05/02						
2.0 150 20V	110	01/01→05/02						
2.0 155 20V	113	04/99→01/01						
2.4 JTD 130	96	04/99→05/02						
1.9 JTD	79	01/01→12/07		→ 12/02; für Linkslenker; GG			24.2122-1716.3 010485	Ø 22,2
FIAT - MAREA Weekend (185_) 09/96→12/07								
 Hauptbremszylinder								
1.2 16V	60	10/98→05/02		04/99→; für Linkslenker; GG			24.2122-1716.3 010485	Ø 22,2
1.4 80 12V	59	09/96→05/02		für Linkslenker; GG			24.2122-1716.3 010485	Ø 22,2
1.6	76	09/00→08/02						
1.6 100 16V	76	09/96→05/02						
1.8 115 16V	83	09/96→05/02						
1.9 JTD 105	77	12/98→12/02						
1.9 JTD 110	81	09/00→08/02						
1.9 TD 100	74	09/96→06/03						
1.9 TD 75	55	09/96→05/02						
2.0 150 20V	110	01/01→05/02						
2.4 JTD 130	96	04/99→05/02						
2.0 155 20V	113	04/99→02/03		→ 12/02; für Linkslenker; GG			24.2122-1716.3 010485	Ø 22,2
FIAT - PALIO (178_, 171_, 371_) 04/96→								
 Hauptbremszylinder								
1.0	45 - 56	04/96→10/03		- ABS			24.2120-1770.3 011066	ATE Ø 20,6 ohne Bremsflüssigkeitsbehälter
1.1	40	07/97→10/03						
1.2	50	06/99→10/00						
1.4	57 - 63	10/02→						
1.2	44	07/97→08/02		10/97→; - ABS			24.2120-1770.3 011066	ATE Ø 20,6 ohne Bremsflüssigkeitsbehälter
1.7 D	42	04/96→09/02						
1.3	59	03/00→01/12		→ 12/06; - ABS			24.2120-1770.3 011066	ATE Ø 20,6 ohne Bremsflüssigkeitsbehälter
1.5	62	06/04→						
1.7 TD	51 - 53	09/01→						
FIAT - PALIO Weekend (178_, 173_, 373_, 374_, 171_) 04/96→								
 Hauptbremszylinder								
1.2	44 - 54	04/96→10/04		10/97→; - ABS			24.2120-1770.3 011066	ATE Ø 20,6 ohne Bremsflüssigkeitsbehälter
1.7 TD	51	04/96→03/01						
→								















	kw					! #		
FIAT - PALIO Weekend (178_, 173_, 373_, 374_, 171_) 04/96→								
 Hauptbremszylinder								
1.2 1.3 1.4	50 59 51 - 57	06/99→10/02 09/01→10/04 07/97→			- ABS		24.2120-1770.3 011066	ATE Ø 20,6 ohne Bremsflüssigkeitsbehälter
1.5 1.9 D 1.9 JTD	62 46 59	02/02→ 03/01→ 09/01→			→ 12/06; - ABS		24.2120-1770.3 011066	ATE Ø 20,6 ohne Bremsflüssigkeitsbehälter
FIAT - PANDA / PANDA CLASSIC (169_) 09/03→								
 Hauptbremszylinder								
1.1 1.2	40 44 - 51	09/03→ 09/03→			→ 06/13; - ABS		24.2120-1744.3 010820	Ø 20,6
1.2 LPG	44 - 51	04/09→			→ 06/13; für Fahrzeuge mit elektronischer Fahrdynamikregelung		24.2120-1746.3 010835	BOS Ø 20,6
1.3 D Multijet	51 - 55	09/03→			→ 06/13; + ABS		24.2120-1747.3 010836	BOS Ø 20,6
1.4 Natural Power	57	09/10→08/13						
1.2 4x4	44	10/04→			→ 06/13; - Diff		24.4120-1702.3 010913	TRW Ø 20,6 ohne Bremsflüssigkeitsbehälter
1.2 4x4	51	04/10→08/13			10/10→ 06/13; - Diff		24.4120-1702.3 010913	TRW Ø 20,6 ohne Bremsflüssigkeitsbehälter
1.2 Natural Power	44	01/07→12/11			- ABS		24.2120-1744.3 010820	Ø 20,6
					für Fahrzeuge mit elektronischer Fahrdynamikregelung		24.2120-1746.3 010835	BOS Ø 20,6
					+ ABS		24.2120-1747.3 010836	BOS Ø 20,6
1.3 D Multijet 4x4	51	10/04→			04/06→ 08/11; - ABS		24.2120-1744.3 010820	Ø 20,6
					04/06→ 08/11; für Fahrzeuge mit elektronischer Fahrdynamikregelung		24.2120-1746.3 010835	BOS Ø 20,6
					04/06→ 08/11; + ABS		24.2120-1747.3 010836	BOS Ø 20,6
					→ 06/13		24.4122-1714.3 010914	TRW Ø 22,2 ohne Bremsflüssigkeitsbehälter
					04/06→ 08/11		24.4122-1714.3 010914	TRW Ø 22,2 ohne Bremsflüssigkeitsbehälter
1.3 JTD Multijet 4x4	55	09/10→08/13			→ 06/13		24.4122-1714.3 010914	TRW Ø 22,2 ohne Bremsflüssigkeitsbehälter
1.4	74	10/06→			11/06→ 06/13; für Fahrzeuge ohne elektronische Fahrdynamikregelung		24.2122-1762.3 010837	Ø 22,2
					11/06→ 06/13; für Fahrzeuge mit elektronischer Fahrdynamikregelung		24.2122-1768.3 010853	Ø 22,2
FIAT - PANDA (141_) 03/80→07/04								
 Hauptbremszylinder								
1100	40	02/95→09/03			→ 12/02; für Linkslenker		24.2119-0826.3 010349	Ø 19
650	22	01/82→07/04			→ 12/85; 6223908→; für Linkslenker		24.2119-0826.3 010349	Ø 19
750	25	01/86→10/03			→ 12/97; für Linkslenker		24.2119-0826.3 010349	Ø 19
 Bremskraftregler								
1100 4x4 1100 Trekking 4x4	40 37	02/95→07/04 10/91→07/04			→ 12/02		24.6046-0801.3 320116	4/6 2x
650	22	01/82→07/04			6166304→ 6261411		24.6046-0801.3 320116	4/6 2x
FIAT - PANDA (312_, 319_) 02/12→								
 Hauptbremszylinder								
0.9 0.9 4x4 0.9 Natural Power	44 - 63 63 - 66	02/12→ 09/12→					24.4122-1721.3 011079	ATE Ø 22,2 ohne Bremsflüssigkeitsbehälter
1.2 1.2 LPG 1.3 D Multijet	51 - 51 55 -	07/12→ 02/12→ 06/12→ 02/12→						
1.3 D Multijet 4x4	70 55 - 70	06/12→						
FIAT - PANDA Kasten/Schrägheck (141_) 01/86→02/04								
 Hauptbremszylinder								
1.1 1000 i.e →	40 33	09/00→02/04 08/92→02/04			→ 12/02; für Linkslenker		24.2119-0826.3 010349	Ø 19











	kw					! #		
FIAT - PANDA Kasten/Schrägheck (141_) 01/86→02/04								
 Bremskraftregler								
1.1 4x4	40	09/00→02/04			→ 12/02		24.6046-0801.3 320116	4/6 2x
FIAT - PANDA Kasten/Schrägheck (169_) 03/04→								
 Hauptbremszylinder								
1.1	40	09/04→			→ 06/13; - ABS		24.2120-1744.3 010820	Ø 20,6
1.2	44 - 51	09/04→			→ 06/13; für Fahrzeuge mit elektronischer Fahrdynamikregelung		24.2120-1746.3 010835	BOS Ø 20,6
1.2 LPG	44	04/09→			→ 06/13; + ABS		24.2120-1747.3 010836	BOS Ø 20,6
1.3 D Multijet	51	03/04→						
1.4 Natural Power	57	10/09→						
1.2 4x4	44	09/04→			10/04→ 06/13; - Diff		24.4120-1702.3 010913	TRW Ø 20,6 ohne Bremsflüssigkeitsbehälter
1.2 4x4	51	09/10→			10/10→ 06/13; - Diff		24.4120-1702.3 010913	TRW Ø 20,6 ohne Bremsflüssigkeitsbehälter
1.2 Bipower	44	09/04→12/11			- ABS		24.2120-1744.3 010820	Ø 20,6
1.2 Natural Power	44	01/07→11/09			für Fahrzeuge mit elektronischer Fahrdynamikregelung		24.2120-1746.3 010835	BOS Ø 20,6
					+ ABS		24.2120-1747.3 010836	BOS Ø 20,6
1.2 LPG	51	09/10→			11/10→ 06/13; - ABS		24.2120-1744.3 010820	Ø 20,6
					11/10→ 06/13; für Fahrzeuge mit elektronischer Fahrdynamikregelung		24.2120-1746.3 010835	BOS Ø 20,6
					11/10→ 06/13; + ABS		24.2120-1747.3 010836	BOS Ø 20,6
1.3 D Multijet	55	01/06→			06/06→ 06/13; - ABS		24.2120-1744.3 010820	Ø 20,6
					06/06→ 06/13; für Fahrzeuge mit elektronischer Fahrdynamikregelung		24.2120-1746.3 010835	BOS Ø 20,6
					06/06→ 06/13; + ABS		24.2120-1747.3 010836	BOS Ø 20,6
1.3 D Multijet 4x4	51	10/04→12/06					24.4122-1714.3 010914	TRW Ø 22,2 ohne Bremsflüssigkeitsbehälter
1.3 D Multijet 4x4	55	01/06→			→ 06/13		24.4122-1714.3 010914	TRW Ø 22,2 ohne Bremsflüssigkeitsbehälter
FIAT - PANDA VAN (312_, 519_) 02/12→								
 Hauptbremszylinder								
0.9	48 - 63	02/12→					24.4122-1721.3 011079	ATE Ø 22,2 ohne Bremsflüssigkeitsbehälter
0.9 4x4	63	09/12→						
0.9 Natural Power	59 - 63	07/12→						
1.2	51	02/12→						
1.2 LPG	51	06/12→						
1.3 D Multijet	55 - 59	02/12→						
1.3 D Multijet 4x4	55 - 59	06/12→						
FIAT - PUNTO (188_) 09/99→07/12								
 Hauptbremszylinder								
1.2 16V 80	59	09/99→04/06			07/03→ 11/05; - ABS		24.2120-1742.3 010776	Ø 20,6
1.2 60	44	09/99→12/10			10/99→ 06/03		24.2120-1742.3 010776	Ø 20,6
					07/03→ 11/05; + ABS		24.2120-1743.3 010777	Ø 20,6
1.2 Bifuel	44	08/07→03/12			10/09→; für Linkslenker		24.4122-1709.3 010871	BOS Ø 22,2 ohne Bremsflüssigkeitsbehälter
					10/09→; für Rechtslenker; + ESP		24.4122-1727.3 011098	Ø 22,2 ohne Bremsflüssigkeitsbehälter
					10/09→; für Rechtslenker; - ESP		24.4122-1739.3 011149	BOS Ø 22,2 ohne Bremsflüssigkeitsbehälter
1.2 Bipower	44	08/01→05/03					24.2120-1742.3 010776	Ø 20,6
1.2 Natural Power	38 - 44	09/03→03/12			→ 11/05; - ABS		24.2120-1742.3 010776	Ø 20,6
					→ 11/05; + ABS		24.2120-1743.3 010777	Ø 20,6
1.3 JTD 16V	51	06/03→03/12			07/03→ 11/05; für Fahrzeuge mit elektronischer Fahrdynamikregelung		24.2122-1768.3 010853	Ø 22,2
1.9 JTD	74	06/03→03/12						
1.4	70 - 71	09/03→03/12			→ 11/05; für Fahrzeuge mit elektronischer Fahrdynamikregelung		24.2122-1768.3 010853	Ø 22,2
1.4	64	08/10→03/12			für Fahrzeuge mit elektronischer Fahrdynamikregelung		24.2122-1768.3 010853	Ø 22,2
1.8 130 HGT	96	09/99→03/12			10/99→ 06/03		24.2120-1742.3 010776	Ø 20,6
					07/03→ 11/05; für Fahrzeuge mit elektronischer Fahrdynamikregelung		24.2122-1768.3 010853	Ø 22,2
1.9 DS 60	44	09/99→03/12			10/99→ 06/03		24.2120-1742.3 010776	Ø 20,6
1.9 JTD 80	59	09/99→03/12						
→								















	kw					! #		
FIAT - PUNTO (188_) 09/99→07/12								
 Hauptbremszylinder								
1.9 JTD	63	10/01→03/12		→ 06/03			24.2120-1742.3 010776	Ø 20,6
				07/03→ 11/05; für Fahrzeuge mit elektronischer Fahrdynamikregelung			24.2122-1768.3 010853	Ø 22,2
FIAT - PUNTO (199_) 01/12→								
 Hauptbremszylinder								
0.9	74 - 77	07/13→		für Linkslenker			24.4122-1709.3 010871	BOS Ø 22,2 ohne Bremsflüssigkeitsbehälter
0.9 Bifuel	63	03/12→		für Rechtslenker; + ESP			24.4122-1727.3 011098	Ø 22,2 ohne Bremsflüssigkeitsbehälter
0.9 Twinair Turbo	63	03/12→						
1.2	49 - 51	03/12→		für Rechtslenker; - ESP			24.4122-1739.3 011149	BOS Ø 22,2 ohne Bremsflüssigkeitsbehälter
1.3 D Multijet	55 - 70	03/12→						
1.3 JTD Multijet	66	05/18→						
1.4	55 - 57	03/12→						
1.4 Bifuel	57	03/12→						
1.4 Multi Air	77	03/12→						
1.4 Natural Power	57	03/12→						
1.4 Turbo Multi Air	99	03/12→						
FIAT - PUNTO Cabriolet (176_) 04/94→06/00								
 Hauptbremszylinder								
60 1.2	43 - 44	04/94→06/00					24.2120-1710.3 010468	Ø 20,6
85 16V 1.2	63	04/97→06/00		06/97→			24.2120-1710.3 010468	Ø 20,6
 Bremskraftregler								
60 1.2	43 - 44	04/94→06/00		→ 05/95; - ABS; 			24.6513-1705.3 320237	lastabhängig 2x
FIAT - PUNTO EVO (199_) 07/08→								
 Hauptbremszylinder								
1.2	48 - 51	10/09→		für Linkslenker			24.4122-1709.3 010871	BOS Ø 22,2 ohne Bremsflüssigkeitsbehälter
1.3 D Multijet	51 - 70	07/08→		für Rechtslenker; + ESP			24.4122-1727.3 011098	Ø 22,2 ohne Bremsflüssigkeitsbehälter
1.4	57	10/09→02/12						
1.4 16V	77 - 99	10/09→02/12		für Rechtslenker; - ESP			24.4122-1739.3 011149	BOS Ø 22,2 ohne Bremsflüssigkeitsbehälter
1.4 LPG	57	06/09→02/12						
1.4 Natural Power	57	10/09→02/12						
1.6 D Multijet	88	10/09→02/12						
1.4	55	07/09→02/12		10/09→; für Linkslenker			24.4122-1709.3 010871	BOS Ø 22,2 ohne Bremsflüssigkeitsbehälter
				10/09→; für Rechtslenker; + ESP			24.4122-1727.3 011098	Ø 22,2 ohne Bremsflüssigkeitsbehälter
				10/09→; für Rechtslenker; - ESP			24.4122-1739.3 011149	BOS Ø 22,2 ohne Bremsflüssigkeitsbehälter
FIAT - PUNTO EVO Kasten/Schrägheck (199_) 03/09→02/12								
 Hauptbremszylinder								
1.3 D Multijet	55 - 70	03/09→02/12		für Linkslenker			24.4122-1709.3 010871	BOS Ø 22,2 ohne Bremsflüssigkeitsbehälter
1.4	57	03/09→02/12		10/09→; für Rechtslenker; + ESP			24.4122-1727.3 011098	Ø 22,2 ohne Bremsflüssigkeitsbehälter
				10/09→; für Rechtslenker; - ESP			24.4122-1739.3 011149	BOS Ø 22,2 ohne Bremsflüssigkeitsbehälter
FIAT - PUNTO Kasten/Schrägheck (188_) 02/00→12/10								
 Hauptbremszylinder								
1.2 60	44	02/00→10/09		07/03→ 11/05; - ABS			24.2120-1742.3 010776	Ø 20,6
				→ 06/03			24.2120-1742.3 010776	Ø 20,6
				07/03→ 11/05; + ABS			24.2120-1743.3 010777	Ø 20,6
1.2 Natural Power	44	01/03→12/10		→ 11/05; - ABS			24.2120-1742.3 010776	Ø 20,6
				→ 11/05; + ABS			24.2120-1743.3 010777	Ø 20,6
1.3 JTD	51	06/03→10/05		07/03→; für Fahrzeuge mit elektronischer Fahrdynamikregelung			24.2122-1768.3 010853	Ø 22,2
1.9 D 60	44	02/00→10/09		→ 06/03			24.2120-1742.3 010776	Ø 20,6
1.9 JTD	63	02/00→10/09						













	kW					! #		
FIAT - PUNTO Kasten/Schrägheck (199_) 04/08→								
 Hauptbremszylinder								
0.9 Twinair Turbo 1.3 D Multijet 1.4 1.4 LPG	63 62 57 57	03/12→ 03/12→ 03/12→ 03/12→		für Linkslenker		24.4122-1709.3	010871	BOS Ø 22,2 ohne Bremsflüssigkeitsbehälter
				für Rechtslenker; + ESP		24.4122-1727.3	011098	Ø 22,2 ohne Bremsflüssigkeitsbehälter
				für Rechtslenker; - ESP		24.4122-1739.3	011149	BOS Ø 22,2 ohne Bremsflüssigkeitsbehälter
1.3 D Multijet	55	04/08→		→ 08/10; für Fahrzeuge mit elektronischer Fahrdynamikregelung		24.4122-1709.3	010871	BOS Ø 22,2 ohne Bremsflüssigkeitsbehälter
				09/10→ 01/11		24.4122-1709.3	010871	BOS Ø 22,2 ohne Bremsflüssigkeitsbehälter
1.3 D Multijet 1.4 Natural Power	70 57	03/09→ 03/09→		10/09→; für Linkslenker		24.4122-1709.3	010871	BOS Ø 22,2 ohne Bremsflüssigkeitsbehälter
				10/09→; für Rechtslenker; + ESP		24.4122-1727.3	011098	Ø 22,2 ohne Bremsflüssigkeitsbehälter
				10/09→; für Rechtslenker; - ESP		24.4122-1739.3	011149	BOS Ø 22,2 ohne Bremsflüssigkeitsbehälter
FIAT - PUNTO Van (176_) 04/96→02/00								
 Hauptbremszylinder								
1.1 1.7 TD 1.7 D	40 52 42	04/96→02/00 04/96→02/00 04/96→02/00		→ 09/99		24.2120-1710.3	010468	Ø 20,6
				→ 05/97		24.2120-1710.3	010468	Ø 20,6
 Bremskraftregler								
1.1	40	04/96→02/00		→ 05/97; - ABS; 		24.6513-1705.3	320237	lastabhängig 2x
				06/97→ 09/99; 		24.6513-1705.3	320237	lastabhängig 2x
FIAT - QUBO (225_) 02/08→								
 Hauptbremszylinder								
1.3 D Multijet 1.4 1.4 Natural Power	59 - 70 57 57	07/10→ 10/09→ 10/09→		für Rechtslenker		24.4122-1727.3	011098	Ø 22,2 ohne Bremsflüssigkeitsbehälter
1.3 D Multijet 1.4	55 54	02/08→ 02/08→		09/08→; für Rechtslenker		24.4122-1727.3	011098	Ø 22,2 ohne Bremsflüssigkeitsbehälter
FIAT - SCUDO Bus (220_) 02/96→12/06								
 Hauptbremszylinder								
1.6 1.9 D 1.9 TD 1.9 TD Eco 2.0 16V 2.0 JTD	58 51 68 66 100 69 - 80	02/96→12/06 04/98→12/06 02/96→12/06 02/96→12/06 06/00→12/06 12/99→12/06		- ABS		24.2122-1703.3	010422	Ø 22,2
				+ ABS		24.2122-1708.3	010437	Ø 22,2
2.0 JTD 16V	80	05/99→12/06		12/99→; - ABS		24.2122-1703.3	010422	Ø 22,2
				12/99→; + ABS		24.2122-1708.3	010437	Ø 22,2
FIAT - SCUDO Bus (270_, 272_) 01/07→03/16								
 Hauptbremszylinder								
1.6 D Multijet 2.0 D Multijet	66 88 - 120	01/07→03/16 01/07→03/16		für Linkslenker; + ESP		03.2125-0671.3	010965	ATE Ø 25,4
				für Linkslenker; - ESP		03.2125-0676.3	011009	ATE Ø 25,4 ohne Bremsflüssigkeitsbehälter
2.0 D Multijet 4x4 2.0 D Multijet 4x4	94 88 - 100	04/11→03/16 01/07→03/16		04/11→; für Linkslenker; + ESP		03.2125-0671.3	010965	ATE Ø 25,4
				04/11→; für Linkslenker; - ESP		03.2125-0676.3	011009	ATE Ø 25,4 ohne Bremsflüssigkeitsbehälter
FIAT - SCUDO Kasten (220_) 02/96→12/06								
 Hauptbremszylinder								
1.6 1.9 D 1.9 TD	58 51 66 - 68	02/96→12/06 02/96→12/06 02/96→12/06		- ABS		24.2122-1703.3	010422	Ø 22,2
				+ ABS		24.2122-1708.3	010437	Ø 22,2
2.0 JTD 2.0	80 100	12/02→12/06 05/00→12/06		06/00→; - ABS		24.2122-1703.3	010422	Ø 22,2
				06/00→; + ABS		24.2122-1708.3	010437	Ø 22,2
2.0 JTD 2.0 JTD 16V	69 80	10/99→12/06 05/99→12/06		12/99→; - ABS		24.2122-1703.3	010422	Ø 22,2
				12/99→; + ABS		24.2122-1708.3	010437	Ø 22,2















	kW					! #		
FIAT - SCUDO Kasten (270_, 272_) 01/07→03/16								
 Hauptbremszylinder								
1.6 D Multijet	66	01/07→03/16		für Linkslenker; + ESP		03.2125-0671.3	010965	ATE Ø 25,4
2.0 D Multijet	88 - 120	01/07→03/16		für Linkslenker; - ESP		03.2125-0676.3	011009	ATE Ø 25,4 ohne Bremsflüssigkeitsbehälter
2.0 D Multijet 4x4	94	05/11→03/16						
2.0 D Multijet 4x4	88 - 100	01/07→03/16		04/11→; für Linkslenker; + ESP		03.2125-0671.3	010965	ATE Ø 25,4
				04/11→; für Linkslenker; - ESP		03.2125-0676.3	011009	ATE Ø 25,4 ohne Bremsflüssigkeitsbehälter
FIAT - SCUDO Pritsche/Fahrgestell (220_) 09/96→12/06								
 Hauptbremszylinder								
1.6	58	09/96→12/06		- ABS		24.2122-1703.3	010422	Ø 22,2
1.9 D	51	04/98→12/06		+ ABS		24.2122-1708.3	010437	Ø 22,2
1.9 TD	68	09/96→12/06						
2.0 JTD	80	12/02→12/06						
2.0 JTD	69	10/99→12/06		12/99→; - ABS		24.2122-1703.3	010422	Ø 22,2
2.0 JTD 16V	80	05/99→12/06		12/99→; + ABS		24.2122-1708.3	010437	Ø 22,2
FIAT - SCUDO Pritsche/Fahrgestell (270_, 272_) 01/07→03/16								
 Hauptbremszylinder								
1.6 D Multijet	66	01/07→03/16		für Linkslenker; + ESP		03.2125-0671.3	010965	ATE Ø 25,4
2.0 D Multijet	88 - 120	01/07→03/16		für Linkslenker; - ESP		03.2125-0676.3	011009	ATE Ø 25,4 ohne Bremsflüssigkeitsbehälter
FIAT - SEDICI (189_) 06/06→10/14								
 Hauptbremszylinder								
1.6 16V	79 - 88	06/06→10/14		für Fahrzeuge ohne elektronische Fahrdynamikregelung		24.4122-1712.3	010899	BOS Ø 22,2 ohne Bremsflüssigkeitsbehälter
1.6 16V 4x4	79 - 88	06/06→10/14		für Fahrzeuge mit elektronischer Fahrdynamikregelung		24.4122-1713.3	010900	BOS Ø 22,2 ohne Bremsflüssigkeitsbehälter
1.9 D Multijet	88	06/06→10/11						
1.9 D Multijet 4x4	88	06/06→10/11						
2.0 D Multijet	99	06/06→10/14						
2.0 D Multijet 4x4	99	06/06→10/14						
FIAT - SEICENTO / 600 (187_) 11/97→01/10								
 Hauptbremszylinder								
0.9	29	11/97→12/08		04/98→ 03/08		24.2119-0833.3	010418	Ø 19
1.1	40	01/98→01/10						
Elektra	30	01/99→01/05		03/00→		24.2119-0833.3	010418	Ø 19
Elettrica	22	03/00→04/04				24.2119-0833.3	010418	Ø 19
FIAT - SEICENTO / 600 Kasten/Schrägheck (287_) 01/98→01/10								
 Hauptbremszylinder								
0.9	29	01/98→01/10		04/98→ 03/08		24.2119-0833.3	010418	Ø 19
1.1	40	01/98→01/10						
FIAT - SIENA (178_, 172_, 372_) 04/96→12/16								
 Hauptbremszylinder								
1.3	59	09/01→12/09		→ 12/06; - ABS		24.2120-1770.3	011066	ATE Ø 20,6 ohne Bremsflüssigkeitsbehälter
FIAT - STRADA Pick-up (178_, 278_) 02/98→								
 Hauptbremszylinder								
1.2	44	04/03→		→ 12/11		24.2122-1781.3	011059	Ø 22,2 ohne Bremsflüssigkeitsbehälter
1.2 Trekking	60	11/05→						
1.3 D Multijet	62	05/06→						
1.9 D	46	12/00→						
1.9 JTD	59	04/03→						
1.2	54	06/99→12/06				24.2122-1781.3	011059	Ø 22,2 ohne Bremsflüssigkeitsbehälter
1.7 TD	51	06/99→12/06						
FIAT - TIPO Kombi (356_, 357_) 03/16→								
 Hauptbremszylinder								
1.0	74	11/20→		Automatikgetriebe		24.4122-1734.3	011117	Ø 22,2 ohne Bremsflüssigkeitsbehälter
1.3 D	70	03/16→10/20						
1.4	70 - 88	03/16→10/20						
1.4 LPG	88	05/16→10/20						
1.6	81	07/16→10/20						
→								











	kw			 	! #		
FIAT - TIPO Kombi (356_, 357_) 03/16→							
 Hauptbremszylinder							
1.6 D	84 - 88	03/16→10/20		Automatikgetriebe		24.4122-1734.3 011117	Ø 22,2 ohne Bremsflüssigkeitsbehälter
1.6 Multijet	96	11/20→					
FIAT - TIPO Schrägheck (356_, 357_) 03/16→							
 Hauptbremszylinder							
1.0	74	11/20→		Automatikgetriebe		24.4122-1734.3 011117	Ø 22,2 ohne Bremsflüssigkeitsbehälter
1.3 D	70	03/16→10/20					
1.4	70 - 88	03/16→10/20					
1.4 LPG	88	05/16→10/20					
1.6 D	84 - 88	03/16→10/20					
1.6 Multijet	96	11/20→					
1.6	81	07/16→10/20				24.4122-1734.3 011117	Ø 22,2 ohne Bremsflüssigkeitsbehälter
FIAT - TIPO Stufenheck (356_, 357_) 10/15→							
 Hauptbremszylinder							
1.0	74	11/20→		Automatikgetriebe		24.4122-1734.3 011117	Ø 22,2 ohne Bremsflüssigkeitsbehälter
1.3 D	70	10/15→10/20					
1.4	70	10/15→10/20					
1.4 LPG	88	05/16→10/20					
1.6 D	84 - 88	10/15→10/20					
1.6 Multijet	96	11/20→					
1.6	81	10/15→10/20				24.4122-1734.3 011117	Ø 22,2 ohne Bremsflüssigkeitsbehälter
FIAT - ULYSSE (179_) 08/02→06/11							
 Hauptbremszylinder							
2.0	100	08/02→06/11		→ 01/11		03.2122-2163.3 010800	ATE Ø 22,2
2.0 D Multijet	88 - 100	05/06→06/11					
2.2 D Multijet	125	03/08→06/11					
2.2 JTD	120	03/08→06/11					
2.0 JTD	79 - 80	08/02→08/06				03.2122-2163.3 010800	ATE Ø 22,2
2.2 JTD	94	08/02→08/06					
FIAT - ULYSSE (220_) 06/94→08/02							
 Hauptbremszylinder							
1.8	73	05/97→08/02		→ 04/99; - ABS		24.2123-1707.3 010492	Ø 23,8
1.9 TD	66	02/95→08/02		05/99→ 07/02; + ABS		24.2123-1733.3 010657	BOS Ø 23,8
2.0	89	06/94→08/02		05/99→ 07/02; - ABS		24.2123-1738.3 010658	Ø 23,8
2.0 16V	97	05/98→09/00		05/99→		24.2123-1733.3 010657	BOS Ø 23,8
2.0 16V	100	09/00→08/02		→ 07/02		24.2123-1733.3 010657	BOS Ø 23,8
2.0 JTD	80	10/99→08/02					
2.0 JTD 16V	80	05/99→08/02					
2.0 Turbo	108	06/94→08/02		05/99→ 07/02		24.2123-1733.3 010657	BOS Ø 23,8
FORD - B-MAX (JK) 10/12→							
 Hauptbremszylinder							
1.0 EcoBoost	74 - 103	10/12→				24.4120-1710.3 011082	Ø 20,6 ohne Bremsflüssigkeitsbehälter
1.4	66	10/12→					
1.4 LPG	64 - 66	08/13→					
1.5 TDCi	55 - 70	10/12→					
1.6 TDCi	70	10/12→					
1.6 Ti	77	10/12→					
FORD - B-MAX Van (JK) 08/12→							
 Hauptbremszylinder							
1.0 EcoBoost	74 - 92	08/12→				24.4120-1710.3 011082	Ø 20,6 ohne Bremsflüssigkeitsbehälter
1.4	66	10/12→					
1.4 LPG	66	10/12→					
1.5 TDCi	55 - 70	10/12→					
1.6 TDCi	70	10/12→					
1.6 Ti	77	10/12→					







	kw			 	! #		
FORD - C-MAX (DM2) 02/07→09/10							
 Bremskraftverstärker							
1.6 1.6 TDCi	74 66 - 80	02/07→09/10 02/07→09/10		03/07→ 04/07		03.7863-0332.4 300203	ATE Ø 10" pneumatisch
1.8 1.8 Flexifuel 1.8 TDCi 2.0 2.0 TDCi	90 - 92 92 85 107 98 - 100	02/07→09/10 02/07→09/10 02/07→09/10 02/07→09/10 02/07→09/10		05/07→; für Fahrzeuge mit Bremsassistent		03.7863-3932.4 300288	ATE Ø 10" pneumatisch
1.6	85	04/07→09/10		→ 04/07		03.7863-0332.4 300203	ATE Ø 10" pneumatisch
				05/07→; für Fahrzeuge mit Bremsassistent		03.7863-3932.4 300288	ATE Ø 10" pneumatisch
2.0 CNG 2.0 LPG 2.0 TDCi	107 107 81	04/09→09/10 06/08→09/10 02/08→09/10		für Fahrzeuge mit Bremsassistent		03.7863-3932.4 300288	ATE Ø 10" pneumatisch
 Hauptbremszylinder							
1.6 1.6 TDCi	74 66 - 80	02/07→09/10 02/07→09/10		03/07→ 05/07		03.2123-3103.3 010781	ATE Ø 23,8
1.8 1.8 Flexifuel 1.8 TDCi 2.0 2.0 TDCi	90 - 92 92 85 107 98 - 100	02/07→09/10 02/07→09/10 02/07→09/10 02/07→09/10 02/07→09/10		06/07→ 10/08		03.2125-0483.3 010783	ATE Ø 25,4 ohne Bremsflüssigkeitsbehälter
				11/08→		03.2125-0661.3 010917	ATE Ø 25,4
1.6	85	04/07→09/10		→ 05/07		03.2123-3103.3 010781	ATE Ø 23,8
				06/07→ 10/08		03.2125-0483.3 010783	ATE Ø 25,4 ohne Bremsflüssigkeitsbehälter
				11/08→		03.2125-0661.3 010917	ATE Ø 25,4
2.0 CNG	107	04/09→09/10				03.2125-0661.3 010917	ATE Ø 25,4
2.0 LPG 2.0 TDCi	107 81	06/08→09/10 02/08→09/10		→ 10/08		03.2125-0483.3 010783	ATE Ø 25,4 ohne Bremsflüssigkeitsbehälter
				11/08→		03.2125-0661.3 010917	ATE Ø 25,4
Hydraulikaggregat, Bremsanlage							
1.6 1.6 TDCi	74 66 - 80	02/07→09/10 02/07→09/10		03/07→		24.9145-0004.2 399008	
1.8 1.8 Flexifuel 1.8 TDCi 2.0 2.0 TDCi	90 - 92 92 85 107 98 - 100	02/07→09/10 02/07→09/10 02/07→09/10 02/07→09/10 02/07→09/10					
1.6 2.0 CNG 2.0 LPG 2.0 TDCi	85 107 107 81	04/07→09/10 04/09→09/10 06/08→09/10 02/08→09/10				24.9145-0004.2 399008	
FORD - C-MAX II (DXA/CB7, DXA/CEU) 04/10→06/19							
 Hauptbremszylinder							
1.0 EcoBoost 1.5 EcoBoost 1.6 CNG 1.6 EcoBoost 1.6 Flexifuel 1.6 LPG 1.6 TDCi 1.6 Ti 2.0 TDCi	74 - 92 110 - 134 86 110 - 134 88 86 - 88 70 - 85 63 - 88 85 - 125	10/12→06/19 03/15→06/19 01/13→12/14 12/10→06/19 02/11→06/19 02/12→06/19 12/10→06/19 12/10→06/19 04/10→06/19				03.4155-5451.3 010995	ATE Ø 25,4
FORD - C-MAX II Van 10/10→06/19							
 Hauptbremszylinder							
1.0 EcoBoost →	74 - 92	10/12→06/19				03.4155-5451.3 010995	ATE Ø 25,4







	kw					! #		
FORD - C-MAX II Van 10/10→06/19								
 Hauptbremszylinder								
1.5 EcoBoost	110 - 134	03/15→06/19					03.4155-5451.3 010995	ATE Ø 25,4
1.6 EcoBoost	110 - 134	12/10→06/19						
1.6 TDCi	70 - 85	12/10→06/19						
1.6 Ti	77	10/10→06/19						
2.0 TDCi	85 - 125	12/10→06/19						
FORD - COUGAR (EC_) 08/98→12/01								
 Hauptbremszylinder								
2.0 16V	96	08/98→12/01		09/98→			24.2125-1709.3 010499	Ø 25,4
2.5 V6 24V	125	08/98→12/01						
2.5 ST 200	151	01/00→12/01					24.2125-1709.3 010499	Ø 25,4
2.5 V6 24V	125	06/00→12/01						
FORD - ESCORT VI Express (AVL) 01/95→06/01								
 Hauptbremszylinder								
1.4	54	01/95→08/00		08/95→ 02/99; + ABS			03.2123-1581.3 010487	Ø 23,8
1.8 D	44	01/95→08/00		02/95→ 02/99; - ABS			24.2123-1732.3 010625	Ø 23,8 ohne Bremsflüssigkeitsbehälter
1.8 TD	66	01/95→08/00		08/95→ 07/00; + ABS			03.2123-1581.3 010487	Ø 23,8
				02/95→ 02/99; - ABS			24.2123-1732.3 010625	Ø 23,8 ohne Bremsflüssigkeitsbehälter
1.8 Turbo D	51	12/95→06/01		→ 07/00; + ABS			03.2123-1581.3 010487	Ø 23,8
				→ 02/99; + ABS			03.2123-1581.3 010487	Ø 23,8
				→ 02/99; - ABS			24.2123-1732.3 010625	Ø 23,8 ohne Bremsflüssigkeitsbehälter
FORD - ESCORT CLASSIC (AAL, ABL) 10/98→07/00								
 Hauptbremszylinder								
1.6 16V	66	10/98→07/00		+ ABS			03.2123-1581.3 010487	Ø 23,8
1.8 TD	66	10/98→07/00		→ 02/99; - ABS			24.2123-1732.3 010625	Ø 23,8 ohne Bremsflüssigkeitsbehälter
FORD - ESCORT CLASSIC Turnier (ANL) 02/99→07/00								
 Hauptbremszylinder								
1.6 16V	66	02/99→07/00		+ ABS			03.2123-1581.3 010487	Ø 23,8
1.8 TD	66	02/99→07/00		→ 02/99; - ABS			24.2123-1732.3 010625	Ø 23,8 ohne Bremsflüssigkeitsbehälter
FORD - FIESTA IV (JA_, JB_) 08/95→06/06								
 Hauptbremszylinder								
1.0 i	48	09/99→01/02		02/00→; + ABS			03.2123-2243.3 010748	ATE Ø 23,8
				02/00→; - ABS			24.2122-1588.3 011028	ATE Ø 22,2 ohne Druckregler
				→ 01/00; - ABS			24.2122-1775.3 010981	Ø 22,2 ohne Bremsflüssigkeitsbehälter
1.25 i 16V	55	08/95→01/02		02/00→; + ABS			03.2123-2243.3 010748	ATE Ø 23,8
				02/00→; - ABS			24.2122-1588.3 011028	ATE Ø 22,2 ohne Druckregler
				01/96→ 01/00; Schaltgetriebe; - ABS			24.2122-1775.3 010981	Ø 22,2 ohne Bremsflüssigkeitsbehälter
1.3 i	37 - 44	08/95→01/02		02/00→; + ABS			03.2123-2243.3 010748	ATE Ø 23,8
1.8 D	44	08/95→04/00		01/96→; - ABS			24.2122-1775.3 010981	Ø 22,2 ohne Bremsflüssigkeitsbehälter
1.4 i 16V	66	04/96→01/02		02/00→; + ABS			03.2123-2243.3 010748	ATE Ø 23,8
1.6 16V Sport	76	02/00→01/02		+ ABS			03.2123-2243.3 010748	ATE Ø 23,8
1.8 DI	55	04/00→01/02		+ ABS			03.2123-2243.3 010748	ATE Ø 23,8
				- ABS			24.2122-1775.3 010981	Ø 22,2 ohne Bremsflüssigkeitsbehälter
FORD - FIESTA V (JH_, JD_) 11/01→12/14								
 Bremskraftverstärker								
1.25 16V	51 - 55	05/02→06/08		für Fahrzeuge ohne Bremsassistent			03.7750-8732.4 300199	ATE Ø 9" pneumatisch
1.3 ROCAM	55	01/02→12/04		für Fahrzeuge mit Bremsassistent			03.7853-2102.4 300201	ATE Ø 9" pneumatisch
1.6	72	05/02→06/08						
1.6 TDCi	66	11/04→06/08						
→								

	kw					! #		
FORD - FIESTA V (JH_, JD_) 11/01→12/14								
 Bremskraftverstärker								
1.3	44 - 51	11/01→06/08		04/02→; für Fahrzeuge ohne Bremsassistent		03.7750-8732.4	300199	ATE Ø 9" pneumatisch
1.4 16V	59	11/01→06/08		04/02→; für Fahrzeuge mit Bremsassistent		03.7853-2102.4	300201	ATE Ø 9" pneumatisch
1.4 TDCi	50	11/01→06/08						
1.6 16V	74	11/01→06/08						
 Hauptbremszylinder								
1.25 16V	51 - 55	05/02→06/08		für Linkslenker; - ABS		03.4153-0015.3	011005	ATE Ø 23,8 ohne Bremsflüssigkeitsbehälter
1.3 ROCAM	55	01/02→12/04		für Linkslenker; + ABS		03.4153-5287.4	010953	ATE Ø 23,8 mit Bremsflüssigkeitsbehälter
1.6	72	05/02→06/08						
1.6 TDCi	66	11/04→06/08						
1.3	44 - 51	11/01→06/08		04/02→; für Linkslenker; - ABS		03.4153-0015.3	011005	ATE Ø 23,8 ohne Bremsflüssigkeitsbehälter
1.4 16V	59	11/01→06/08		04/02→; für Linkslenker; + ABS		03.4153-5287.4	010953	ATE Ø 23,8 mit Bremsflüssigkeitsbehälter
1.4 TDCi	50	11/01→06/08						
1.6 16V	74	11/01→06/08						
FORD - FIESTA V Van 05/02→12/10								
 Bremskraftverstärker								
1.3	44 - 51	05/02→08/08		für Fahrzeuge ohne Bremsassistent		03.7750-8732.4	300199	ATE Ø 9" pneumatisch
1.4	59	05/02→09/05		für Fahrzeuge mit Bremsassistent		03.7853-2102.4	300201	ATE Ø 9" pneumatisch
1.4 TDCi	50	10/03→12/10		→ 08/08; für Fahrzeuge ohne Bremsassistent		03.7750-8732.4	300199	ATE Ø 9" pneumatisch
1.6 TDCi	66	04/07→09/09						
				→ 08/08; für Fahrzeuge mit Bremsassistent		03.7853-2102.4	300201	ATE Ø 9" pneumatisch
 Hauptbremszylinder								
1.3	44 - 51	05/02→08/08		für Linkslenker; - ABS		03.4153-0015.3	011005	ATE Ø 23,8 ohne Bremsflüssigkeitsbehälter
1.4	59	05/02→09/05		für Linkslenker; + ABS		03.4153-5287.4	010953	ATE Ø 23,8 mit Bremsflüssigkeitsbehälter
1.4 TDCi	50	10/03→12/10		→ 08/08; für Linkslenker; - ABS		03.4153-0015.3	011005	ATE Ø 23,8 ohne Bremsflüssigkeitsbehälter
1.6 TDCi	66	04/07→09/09						
				→ 08/08; für Linkslenker; + ABS		03.4153-5287.4	010953	ATE Ø 23,8 mit Bremsflüssigkeitsbehälter
FORD - FIESTA VI (CB1, CCN) 06/08→								
 Hauptbremszylinder								
1.0	48 - 59	10/12→04/17		+ ABS		24.4120-1710.3	011082	Ø 20,6 ohne Bremsflüssigkeitsbehälter
1.0 EcoBoost	74	01/13→04/17		- ABS		24.4120-1711.3	011093	Ø 20,6 ohne Bremsflüssigkeitsbehälter
1.0 Sport	103	05/14→04/17						
1.4	71	10/08→04/17						
1.4 TDCi	50 - 51	08/08→09/12						
1.5 TDCi	70	05/15→04/17						
1.6	62 - 90	10/10→04/17						
1.6 TDCi	70	02/10→12/15						
1.6 Ti	99	12/10→04/17						
1.0 EcoBoost	92	09/12→04/17		+ ABS		24.4120-1710.3	011082	Ø 20,6 ohne Bremsflüssigkeitsbehälter
1.5 TDCi	55	09/12→04/17		10/12→; - ABS		24.4120-1711.3	011093	Ø 20,6 ohne Bremsflüssigkeitsbehälter
1.6 Ti	77	09/12→04/17						
1.25	44 - 60	06/08→04/17		+ ABS		24.4120-1710.3	011082	Ø 20,6 ohne Bremsflüssigkeitsbehälter
1.6 TDCi	55 - 66	06/08→12/12		09/08→; - ABS		24.4120-1711.3	011093	Ø 20,6 ohne Bremsflüssigkeitsbehälter
1.6 Ti	88	06/08→01/18						
1.4 LPG	68 - 71	01/09→04/17		+ ABS		24.4120-1710.3	011082	Ø 20,6 ohne Bremsflüssigkeitsbehälter
				06/09→; - ABS		24.4120-1711.3	011093	Ø 20,6 ohne Bremsflüssigkeitsbehälter
1.6 ST	134	03/13→04/17				24.4122-1733.3	011116	Ø 22,2 ohne Bremsflüssigkeitsbehälter
1.6 ST200	147	04/16→04/17						
FORD - FIESTA VI Van 08/08→04/17								
 Hauptbremszylinder								
1.0	48 - 59	10/12→04/17		+ ABS		24.4120-1710.3	011082	Ø 20,6 ohne Bremsflüssigkeitsbehälter
1.0 EcoBoost	74 - 103	01/13→04/17		- ABS		24.4120-1711.3	011093	Ø 20,6 ohne Bremsflüssigkeitsbehälter
→								

	kw					! #		
FORD - FIESTA VI Van 08/08→04/17								
 Hauptbremszylinder								
1.25	44	08/08→04/17		+ ABS		24.4120-1710.3	011082	Ø 20,6 ohne Bremsflüssigkeitsbehälter
1.4	60	10/08→12/12						
1.4 TDCi	71	01/09→04/17		- ABS		24.4120-1711.3	011093	Ø 20,6 ohne Bremsflüssigkeitsbehälter
1.5 TDCi	50	10/12→04/17						
1.6 TDCi	51	01/09→04/17						
1.6 Ti-VCT	70	10/08→12/12						
1.0 EcoBoost	66	09/12→04/17		+ ABS		24.4120-1710.3	011082	Ø 20,6 ohne Bremsflüssigkeitsbehälter
	70			10/12→; - ABS		24.4120-1711.3	011093	Ø 20,6 ohne Bremsflüssigkeitsbehälter
1.6 ST	88	03/13→04/17				24.4122-1733.3	011116	Ø 22,2 ohne Bremsflüssigkeitsbehälter
FORD - FIESTA Kasten/Großraumlimousine (J5_, J3_) 02/96→								
 Hauptbremszylinder								
1.3	44	02/96→08/03		02/00→ 03/02; - ABS		24.2122-1588.3	011028	ATE Ø 22,2 ohne Druckregler
1.8 D	44	02/96→04/02						
1.8 DI	55	09/00→08/03		→ 03/02; + ABS		03.2123-2243.3	010748	ATE Ø 23,8
				→ 03/02; - ABS		24.2122-1775.3	010981	Ø 22,2 ohne Bremsflüssigkeitsbehälter
FORD - FIESTA Kasten/Schrägheck (JV_) 05/98→08/03								
 Hauptbremszylinder								
D 1.8	44	05/98→04/02		02/00→ 03/02; - ABS		24.2122-1588.3	011028	ATE Ø 22,2 ohne Druckregler
TD 1.8	55	03/00→08/03		→ 03/02; - ABS		24.2122-1588.3	011028	ATE Ø 22,2 ohne Druckregler
FORD - FIESTA Stufenheck 09/00→12/14								
 Bremskraftverstärker								
1.0	70	09/04→12/06		für Fahrzeuge ohne Bremsassistent		03.7750-8732.4	300199	ATE Ø 9" pneumatisch
1.4 TDCi	50	05/02→11/11						
1.6	73	05/02→11/13		für Fahrzeuge mit Bremsassistent		03.7853-2102.4	300201	ATE Ø 9" pneumatisch
 Hauptbremszylinder								
1.0	70	09/04→12/06		für Linkslenker; - ABS		03.4153-0015.3	011005	ATE Ø 23,8 ohne Bremsflüssigkeitsbehälter
1.4 TDCi	50	05/02→11/11						
1.6	73	05/02→11/13		für Linkslenker; + ABS		03.4153-5287.4	010953	ATE Ø 23,8 mit Bremsflüssigkeitsbehälter
FORD - FIESTA Stufenheck 04/10→04/17								
 Hauptbremszylinder								
1.4	70	10/10→04/17		+ ABS		24.4120-1710.3	011082	Ø 20,6 ohne Bremsflüssigkeitsbehälter
1.6	62	09/10→04/17						
1.6 Ti	81	04/10→04/17		- ABS		24.4120-1711.3	011093	Ø 20,6 ohne Bremsflüssigkeitsbehälter
	88							
FORD - FOCUS I (DAW, DBW) 09/98→11/09								
 Hauptbremszylinder								
1.4 16V	55	10/98→11/04		11/01→ 09/04; + ESP		03.4123-0153.3	010659	ATE Ø 23,8
1.6 16V	74	10/98→11/04		→ 09/04; + ABS		24.4123-1713.3	010905	BOS Ø 23,8 ohne Bremsflüssigkeitsbehälter
1.8 16V	85	10/98→11/04						
1.8 DI / TDDi	55	08/99→11/04						
1.8 TDCi	85	03/01→11/04						
1.8 Turbo DI / TDDi	66	10/98→11/04						
2.0 16V	96	10/98→11/04						
1.6	76	07/03→06/07		+ ESP		03.4123-0153.3	010659	ATE Ø 23,8
1.8 16V BiFuel	85	09/02→07/04		+ ABS		24.4123-1713.3	010905	BOS Ø 23,8 ohne Bremsflüssigkeitsbehälter
1.6 16V Flexifuel	75	01/02→11/04		→ 09/04; + ESP		03.4123-0153.3	010659	ATE Ø 23,8
1.8 TDCi	74	08/02→11/04		→ 09/04; + ABS		24.4123-1713.3	010905	BOS Ø 23,8 ohne Bremsflüssigkeitsbehälter
FORD - FOCUS I Kasten/Kombi (DNW) 08/98→03/05								
 Hauptbremszylinder								
1.4	55	04/99→03/05		11/01→ 09/04; + ESP		03.4123-0153.3	010659	ATE Ø 23,8
1.6	74	04/99→03/05						
1.8	85	04/99→03/05						
→								

	kw					! #		
FORD - FOCUS I Kasten/Kombi (DNW) 08/98→03/05								
 Hauptbremszylinder								
1.8 TDCi 1.8 TDDi	85 55 - 66	08/01→03/05 08/98→03/05		→ 09/04; + ABS			24.4123-1713.3 010905	BOS Ø 23,8 ohne Bremsflüssigkeitsbehälter
1.8 TDCi	74	08/02→03/05		→ 09/04; + ESP			03.4123-0153.3 010659	ATE Ø 23,8
				→ 09/04; + ABS			24.4123-1713.3 010905	BOS Ø 23,8 ohne Bremsflüssigkeitsbehälter
FORD - FOCUS I Stufenheck (DFW) 02/99→11/09								
 Hauptbremszylinder								
1.4 16V 1.6 16V 1.8 16V 1.8 TDCi 1.8 Turbo DI / TDDi	55 74 85 85 55 - 66	02/99→11/04 02/99→11/04 02/99→11/04 03/01→11/04 02/99→03/05		11/01→ 09/04; + ESP			03.4123-0153.3 010659	ATE Ø 23,8
				→ 09/04; + ABS			24.4123-1713.3 010905	BOS Ø 23,8 ohne Bremsflüssigkeitsbehälter
2.0 16V 1.8 TDCi	96 74	02/99→11/04 08/02→11/04		→ 09/04; + ESP			03.4123-0153.3 010659	ATE Ø 23,8
				→ 09/04; + ABS			24.4123-1713.3 010905	BOS Ø 23,8 ohne Bremsflüssigkeitsbehälter
FORD - FOCUS I Turnier (DNW) 02/99→12/07								
 Hauptbremszylinder								
1.4 16V 1.6 16V 1.8 16V 1.8 DI / TDDi 1.8 TDCi 1.8 Turbo DI / TDDi 2.0 16V	55 74 85 55 85 66 96	02/99→11/04 02/99→11/04 02/99→11/04 08/99→11/04 03/01→11/04 02/99→11/04 02/99→11/04		11/01→ 09/04; + ESP			03.4123-0153.3 010659	ATE Ø 23,8
				→ 09/04; + ABS			24.4123-1713.3 010905	BOS Ø 23,8 ohne Bremsflüssigkeitsbehälter
1.6 16V Flexifuel 1.8 TDCi	75 74	01/02→11/04 08/02→11/04		→ 09/04; + ESP			03.4123-0153.3 010659	ATE Ø 23,8
				→ 09/04; + ABS			24.4123-1713.3 010905	BOS Ø 23,8 ohne Bremsflüssigkeitsbehälter
1.8 BiFuel	82	02/03→01/05		+ ESP			03.4123-0153.3 010659	ATE Ø 23,8
				+ ABS			24.4123-1713.3 010905	BOS Ø 23,8 ohne Bremsflüssigkeitsbehälter
FORD - FOCUS II (DA_, HCP, DP) 07/04→09/13								
 Bremskraftverstärker								
1.4 1.6 1.6 TDCi	59 74 74 - 80	07/04→09/12 07/04→09/12 07/04→09/12		05/07→ 02/11; + ABS / für Fahrzeuge ohne Bremsassistent			03.7760-2232.4 300266	ATE Ø 10" pneumatisch
				10/04→ 02/11; - ABS / für Fahrzeuge ohne Bremsassistent			03.7760-2332.4 300267	ATE Ø 10" pneumatisch
1.6 Ti 2.0 2.0 TDCi	85 107 100	07/04→09/12 07/04→09/12 07/04→09/12		10/04→ 04/07; + ABS / für Fahrzeuge ohne Bremsassistent			03.7760-8103.4 300240	ATE Ø 10" pneumatisch
				10/04→ 04/07; + ABS / für Fahrzeuge mit Bremsassistent			03.7863-0332.4 300203	ATE Ø 10" pneumatisch
				05/07→ 02/11; + ABS / für Fahrzeuge mit Bremsassistent			03.7863-3932.4 300288	ATE Ø 10" pneumatisch
1.6 2.0 Flex	81 107	01/10→09/12 10/08→03/10		+ ABS / für Fahrzeuge ohne Bremsassistent			03.7760-2232.4 300266	ATE Ø 10" pneumatisch
				- ABS / für Fahrzeuge ohne Bremsassistent			03.7760-2332.4 300267	ATE Ø 10" pneumatisch
				+ ABS / für Fahrzeuge mit Bremsassistent			03.7863-3932.4 300288	ATE Ø 10" pneumatisch
1.6 LPG 2.0 CNG 2.0 LPG 2.0 TDCi	85 107 107 81	10/09→07/11 04/09→07/11 06/08→07/11 02/08→07/11		→ 02/11; + ABS / für Fahrzeuge ohne Bremsassistent			03.7760-2232.4 300266	ATE Ø 10" pneumatisch
				→ 02/11; - ABS / für Fahrzeuge ohne Bremsassistent			03.7760-2332.4 300267	ATE Ø 10" pneumatisch
				→ 02/11; + ABS / für Fahrzeuge mit Bremsassistent			03.7863-3932.4 300288	ATE Ø 10" pneumatisch
1.6 TDCi 1.8 1.8 Flexifuel 1.8 TDCi	66 92 92 85	01/05→09/12 03/06→09/12 01/06→09/12 01/05→09/12		05/07→ 02/11; + ABS / für Fahrzeuge ohne Bremsassistent			03.7760-2232.4 300266	ATE Ø 10" pneumatisch
				→ 02/11; - ABS / für Fahrzeuge ohne Bremsassistent			03.7760-2332.4 300267	ATE Ø 10" pneumatisch
				→ 04/07; + ABS / für Fahrzeuge ohne Bremsassistent			03.7760-8103.4 300240	ATE Ø 10" pneumatisch
				→ 04/07; + ABS / für Fahrzeuge mit Bremsassistent			03.7863-0332.4 300203	ATE Ø 10" pneumatisch
				05/07→ 02/11; + ABS / für Fahrzeuge mit Bremsassistent			03.7863-3932.4 300288	ATE Ø 10" pneumatisch
2.0 →	104	06/05→09/08		05/07→; + ABS / für Fahrzeuge ohne Bremsassistent			03.7760-2232.4 300266	ATE Ø 10" pneumatisch

	kw			 	! #		
FORD - FOCUS II (DA_, HCP, DP) 07/04→09/13							
Bremskraftverstärker							
2.0	104	06/05→09/08		- ABS / für Fahrzeuge ohne Bremsassistent	03.7760-2332.4	300267	ATE Ø 10" pneumatisch
				→ 04/07; + ABS / für Fahrzeuge ohne Bremsassistent	03.7760-8103.4	300240	ATE Ø 10" pneumatisch
				→ 04/07; + ABS / für Fahrzeuge mit Bremsassistent	03.7863-0332.4	300203	ATE Ø 10" pneumatisch
				05/07→; + ABS / für Fahrzeuge mit Bremsassistent	03.7863-3932.4	300288	ATE Ø 10" pneumatisch
2.0 TDCi	98	07/04→01/08		05/07→; + ABS / für Fahrzeuge ohne Bremsassistent	03.7760-2232.4	300266	ATE Ø 10" pneumatisch
				10/04→; - ABS / für Fahrzeuge ohne Bremsassistent	03.7760-2332.4	300267	ATE Ø 10" pneumatisch
				10/04→ 04/07; + ABS / für Fahrzeuge ohne Bremsassistent	03.7760-8103.4	300240	ATE Ø 10" pneumatisch
				10/04→ 04/07; + ABS / für Fahrzeuge mit Bremsassistent	03.7863-0332.4	300203	ATE Ø 10" pneumatisch
				05/07→; + ABS / für Fahrzeuge mit Bremsassistent	03.7863-3932.4	300288	ATE Ø 10" pneumatisch
2.5 RS 2.5 RS 500	224 257	01/09→07/11 05/10→07/11		für Linkslenker; → 02/11	03.7755-3532.4	300290	ATE Ø 9 / 8" pneumatisch
Hauptbremszylinder							
1.4	59	07/04→09/12		10/04→ 04/07; + ABS	03.2123-3103.3	010781	ATE Ø 23,8
1.6	74	07/04→09/12		05/07→ 10/08; + ABS	03.2125-0483.3	010783	ATE Ø 25,4 ohne Bremsflüssigkeitsbehälter
1.6 TDCi	74 - 80	07/04→09/12					
1.6 Ti	85	07/04→09/12		11/08→ 02/11; + ABS	03.2125-0661.3	010917	ATE Ø 25,4
2.0	107	07/04→09/12		10/04→ 02/11; - ABS	24.2123-3041.3	011021	ATE Ø 23,8 ohne Bremsflüssigkeitsbehälter / ohne Druckregler
2.0 TDCi	100	07/04→09/12					
1.6	81	01/10→09/12		+ ABS	03.2125-0661.3	010917	ATE Ø 25,4
				- ABS	24.2123-3041.3	011021	ATE Ø 23,8 ohne Bremsflüssigkeitsbehälter / ohne Druckregler
1.6 LPG 2.0 CNG	85 107	10/09→07/11 04/09→07/11		→ 02/11; + ABS	03.2125-0661.3	010917	ATE Ø 25,4
				→ 02/11; - ABS	24.2123-3041.3	011021	ATE Ø 23,8 ohne Bremsflüssigkeitsbehälter / ohne Druckregler
1.6 TDCi	66	01/05→09/12		→ 04/07; + ABS	03.2123-3103.3	010781	ATE Ø 23,8
1.8	92	03/06→09/12		05/07→ 10/08; + ABS	03.2125-0483.3	010783	ATE Ø 25,4 ohne Bremsflüssigkeitsbehälter
1.8 Flexifuel	92	01/06→09/12					
1.8 TDCi	85	01/05→09/12		11/08→ 02/11; + ABS	03.2125-0661.3	010917	ATE Ø 25,4
2.5 ST	166	10/05→09/12		→ 02/11; - ABS	24.2123-3041.3	011021	ATE Ø 23,8 ohne Bremsflüssigkeitsbehälter / ohne Druckregler
2.0	104	06/05→09/08		→ 04/07; + ABS	03.2123-3103.3	010781	ATE Ø 23,8
				05/07→; + ABS	03.2125-0483.3	010783	ATE Ø 25,4 ohne Bremsflüssigkeitsbehälter
				- ABS	24.2123-3041.3	011021	ATE Ø 23,8 ohne Bremsflüssigkeitsbehälter / ohne Druckregler
2.0 Flex	107	10/08→03/10		+ ABS	03.2125-0661.3	010917	ATE Ø 25,4
2.0 LPG 2.0 TDCi	107 81	06/08→07/11 02/08→07/11		→ 10/08; + ABS	03.2125-0483.3	010783	ATE Ø 25,4 ohne Bremsflüssigkeitsbehälter
				11/08→ 02/11; + ABS	03.2125-0661.3	010917	ATE Ø 25,4
				→ 02/11; - ABS	24.2123-3041.3	011021	ATE Ø 23,8 ohne Bremsflüssigkeitsbehälter / ohne Druckregler
2.0 TDCi	98	07/04→01/08		10/04→ 04/07; + ABS	03.2123-3103.3	010781	ATE Ø 23,8
				05/07→; + ABS	03.2125-0483.3	010783	ATE Ø 25,4 ohne Bremsflüssigkeitsbehälter
				10/04→; - ABS	24.2123-3041.3	011021	ATE Ø 23,8 ohne Bremsflüssigkeitsbehälter / ohne Druckregler
2.5 RS 2.5 RS 500	224 257	01/09→07/11 05/10→07/11		für Linkslenker; → 02/11	03.2125-0651.3	010935	ATE Ø 25,4
Hydraulikaggregat, Bremsanlage							
1.4 1.6 1.6 TDCi	59 74 74 - 80	07/04→09/12 07/04→09/12 07/04→09/12		10/04→ 02/11	24.9145-0004.2	399008	
1.6 Ti	85	07/04→09/12					
2.0	107	07/04→09/12					
2.0 TDCi	100	07/04→09/12					
1.6 2.0 2.0 Flex	81 104 107	01/10→09/12 06/05→09/08 10/08→03/10			24.9145-0004.2	399008	
1.6 LPG 1.6 TDCi →	85 66	10/09→07/11 01/05→09/12		→ 02/11	24.9145-0004.2	399008	

	kw					! #		
FORD - FOCUS II (DA_, HCP, DP) 07/04→09/13								
Hydraulikaggregat, Bremsanlage								
1.8	92	03/06→09/12		→ 02/11			24.9145-0004.2	399008
1.8 Flexifuel	92	01/06→09/12						
1.8 TDCi	85	01/05→09/12						
2.0 CNG	107	04/09→07/11						
2.0 LPG	107	06/08→07/11						
2.0 TDCi	81	02/08→07/11						
2.5 ST	166	10/05→09/12						
2.0 TDCi	98	07/04→01/08		10/04→			24.9145-0004.2	399008
FORD - FOCUS II Cabriolet 10/06→09/10								
Bremskraftverstärker								
1.6	74	10/06→09/10		05/07→; + ABS / für Fahrzeuge ohne Bremsassistent			03.7760-2232.4	300266
2.0	107	10/06→09/10						ATE Ø 10" pneumatisch
2.0 TDCi	100	10/06→09/10		- ABS / für Fahrzeuge ohne Bremsassistent			03.7760-2332.4	300267
				→ 04/07; + ABS / für Fahrzeuge ohne Bremsassistent			03.7760-8103.4	300240
				→ 04/07; + ABS / für Fahrzeuge mit Bremsassistent			03.7863-0332.4	300203
				05/07→; + ABS / für Fahrzeuge mit Bremsassistent			03.7863-3932.4	300288
Hauptbremszylinder								
1.6	74	10/06→09/10		→ 04/07; + ABS			03.2123-3103.3	010781
2.0	107	10/06→09/10						ATE Ø 23,8
2.0 TDCi	100	10/06→09/10		05/07→ 10/08; + ABS			03.2125-0483.3	010783
				11/08→; + ABS			03.2125-0661.3	010917
				- ABS			24.2123-3041.3	011021
Hydraulikaggregat, Bremsanlage								
1.6	74	10/06→09/10					24.9145-0004.2	399008
2.0	107	10/06→09/10						
2.0 TDCi	100	10/06→09/10						
FORD - FOCUS II Kasten/Kombi 07/04→07/11								
Bremskraftverstärker								
1.4	59	09/05→07/11		05/07→ 02/11; + ABS / für Fahrzeuge ohne Bremsassistent			03.7760-2232.4	300266
1.6	74	09/05→07/11						ATE Ø 10" pneumatisch
1.6 TDCi	66 - 80	07/04→07/11		→ 02/11; - ABS / für Fahrzeuge ohne Bremsassistent			03.7760-2332.4	300267
1.6 Ti-VCT	85	09/05→07/11		→ 04/07; + ABS / für Fahrzeuge ohne Bremsassistent			03.7760-8103.4	300240
2.0 TDCi	100	09/05→07/11		→ 04/07; + ABS / für Fahrzeuge mit Bremsassistent			03.7863-0332.4	300203
				05/07→ 02/11; + ABS / für Fahrzeuge mit Bremsassistent			03.7863-3932.4	300288
1.8 Flexifuel	92	06/09→07/11		+ ABS / für Fahrzeuge ohne Bremsassistent			03.7760-2232.4	300266
				- ABS / für Fahrzeuge ohne Bremsassistent			03.7760-8103.4	300240
				+ ABS / für Fahrzeuge mit Bremsassistent			03.7863-0332.4	300203
							03.7863-3932.4	300288
2.0 TDCi	81	06/09→07/11		→ 02/11; + ABS / für Fahrzeuge ohne Bremsassistent			03.7760-2232.4	300266
				→ 02/11; - ABS / für Fahrzeuge ohne Bremsassistent			03.7760-2332.4	300267
				→ 02/11; + ABS / für Fahrzeuge mit Bremsassistent			03.7863-3932.4	300288
Hauptbremszylinder								
1.4	59	09/05→07/11		+ ABS			03.2123-3103.3	010781
				05/07→ 10/08; + ABS			03.2125-0483.3	010783
				11/08→ 02/11; + ABS			03.2125-0661.3	010917
				- ABS			24.2123-3041.3	011021
1.6	74	09/05→07/11		+ ABS			03.2123-3103.3	010781
				05/07→ 10/08; + ABS			03.2125-0483.3	010783
				11/08→ 02/11; + ABS			03.2125-0661.3	010917
→								

FORD - FOCUS II Kasten/Kombi 07/04→07/11

Hauptbremszylinder

1.6	74	09/05→07/11		→ 02/11; - ABS	24.2123-3041.3	011021	ATE Ø 23,8 ohne Bremsflüssigkeitsbehälter / ohne Druckregler
1.6 TDCi	66 - 80	07/04→07/11		→ 04/07; + ABS	03.2123-3103.3	010781	ATE Ø 23,8
1.6 Ti-VCT	85	09/05→07/11		05/07→ 10/08; + ABS	03.2125-0483.3	010783	ATE Ø 25,4 ohne Bremsflüssigkeitsbehälter
2.0 TDCi	100	09/05→07/11		11/08→ 02/11; + ABS	03.2125-0661.3	010917	ATE Ø 25,4
				→ 02/11; - ABS	24.2123-3041.3	011021	ATE Ø 23,8 ohne Bremsflüssigkeitsbehälter / ohne Druckregler
1.8 Flexifuel	92	06/09→07/11		→ 02/11; + ABS	03.2125-0661.3	010917	ATE Ø 25,4
2.0 TDCi	81	06/09→07/11		+ ABS	03.2125-0483.3	010783	ATE Ø 25,4 ohne Bremsflüssigkeitsbehälter
				→ 02/11; + ABS	03.2125-0661.3	010917	ATE Ø 25,4
				→ 02/11; - ABS	24.2123-3041.3	011021	ATE Ø 23,8 ohne Bremsflüssigkeitsbehälter / ohne Druckregler

Hydraulikaggregat, Bremsanlage

1.4	59	09/05→07/11			24.9145-0004.2	399008	
1.6	74	09/05→07/11					
1.8 Flexifuel	92	06/09→07/11					
1.6 TDCi	66 - 80	07/04→07/11		→ 02/11	24.9145-0004.2	399008	
1.6 Ti-VCT	85	09/05→07/11					
2.0 TDCi	81 - 100	09/05→07/11					

FORD - FOCUS II Stufenheck (DB_, FCH, DH) 04/05→

Bremskraftverstärker

1.4	59	04/05→09/12		05/07→ 02/11; + ABS / für Fahrzeuge ohne Bremsassistent	03.7760-2232.4	300266	ATE Ø 10" pneumatisch
1.6	74	04/05→09/12					
1.6 TDCi	66 - 80	04/05→09/12		→ 02/11; - ABS / für Fahrzeuge ohne Bremsassistent	03.7760-2332.4	300267	ATE Ø 10" pneumatisch
1.6 Ti	85	04/05→09/12					
1.8	92	03/06→09/12		→ 04/07; + ABS / für Fahrzeuge ohne Bremsassistent	03.7760-8103.4	300240	ATE Ø 10" pneumatisch
1.8 Flexifuel	92	06/06→07/11					
1.8 TDCi	85	04/05→09/12		→ 04/07; + ABS / für Fahrzeuge mit Bremsassistent	03.7863-0332.4	300203	ATE Ø 10" pneumatisch
2.0	107	04/05→07/11					
2.0 TDCi	100	04/05→09/12		05/07→ 02/11; + ABS / für Fahrzeuge mit Bremsassistent	03.7863-3932.4	300288	ATE Ø 10" pneumatisch
1.6	81	03/10→		+ ABS / für Fahrzeuge ohne Bremsassistent	03.7760-2232.4	300266	ATE Ø 10" pneumatisch
				- ABS / für Fahrzeuge ohne Bremsassistent	03.7760-2332.4	300267	ATE Ø 10" pneumatisch
				+ ABS / für Fahrzeuge mit Bremsassistent	03.7863-3932.4	300288	ATE Ø 10" pneumatisch
1.8 Flexifuel	96	12/05→01/08		05/07→; + ABS / für Fahrzeuge ohne Bremsassistent	03.7760-2232.4	300266	ATE Ø 10" pneumatisch
				01/06→; - ABS / für Fahrzeuge ohne Bremsassistent	03.7760-2332.4	300267	ATE Ø 10" pneumatisch
				01/06→ 04/07; + ABS / für Fahrzeuge ohne Bremsassistent	03.7760-8103.4	300240	ATE Ø 10" pneumatisch
				01/06→ 04/07; + ABS / für Fahrzeuge mit Bremsassistent	03.7863-0332.4	300203	ATE Ø 10" pneumatisch
				05/07→; + ABS / für Fahrzeuge mit Bremsassistent	03.7863-3932.4	300288	ATE Ø 10" pneumatisch
2.0 TDCi	81	02/08→07/11		→ 02/11; + ABS / für Fahrzeuge ohne Bremsassistent	03.7760-2232.4	300266	ATE Ø 10" pneumatisch
				→ 02/11; - ABS / für Fahrzeuge ohne Bremsassistent	03.7760-2332.4	300267	ATE Ø 10" pneumatisch
				→ 02/11; + ABS / für Fahrzeuge mit Bremsassistent	03.7863-3932.4	300288	ATE Ø 10" pneumatisch

Hauptbremszylinder

1.4	59	04/05→09/12		→ 04/07; + ABS	03.2123-3103.3	010781	ATE Ø 23,8
1.6	74	04/05→09/12					
1.6 TDCi	66 - 80	04/05→09/12		05/07→ 10/08; + ABS	03.2125-0483.3	010783	ATE Ø 25,4 ohne Bremsflüssigkeitsbehälter
1.6 Ti	85	04/05→09/12		11/08→ 02/11; + ABS	03.2125-0661.3	010917	ATE Ø 25,4
1.8	92	03/06→09/12					
1.8 Flexifuel	92	06/06→07/11		→ 02/11; - ABS	24.2123-3041.3	011021	ATE Ø 23,8 ohne Bremsflüssigkeitsbehälter / ohne Druckregler
1.8 TDCi	85	04/05→09/12					
2.0	107	04/05→07/11					
2.0 TDCi	100	04/05→09/12					
1.6	81	03/10→		+ ABS	03.2125-0661.3	010917	ATE Ø 25,4
				- ABS	24.2123-3041.3	011021	ATE Ø 23,8 ohne Bremsflüssigkeitsbehälter / ohne Druckregler

FORD - FOCUS II Stufenheck (DB_, FCH, DH) 04/05→

Hauptbremszylinder

1.8 Flexifuel	96	12/05→01/08	01/06→ 04/07; + ABS	03.2123-3103.3	010781	ATE Ø 23,8
			05/07→; + ABS	03.2125-0483.3	010783	ATE Ø 25,4 ohne Bremsflüssigkeitsbehälter
			01/06→; - ABS	24.2123-3041.3	011021	ATE Ø 23,8 ohne Bremsflüssigkeitsbehälter / ohne Druckregler
2.0 TDCi	81	02/08→07/11	→ 10/08; + ABS	03.2125-0483.3	010783	ATE Ø 25,4 ohne Bremsflüssigkeitsbehälter
			11/08→ 02/11; + ABS	03.2125-0661.3	010917	ATE Ø 25,4
			→ 02/11; - ABS	24.2123-3041.3	011021	ATE Ø 23,8 ohne Bremsflüssigkeitsbehälter / ohne Druckregler

Hydraulikaggregat, Bremsanlage

1.4	59	04/05→09/12	→ 02/11	24.9145-0004.2	399008				
1.6	74	04/05→09/12							
1.6 TDCi	66 - 80	04/05→09/12							
1.6 Ti	85	04/05→09/12							
1.8	92	03/06→09/12							
1.8 Flexifuel	92	06/06→07/11							
1.8 TDCi	85	04/05→09/12							
2.0	107	04/05→07/11							
2.0 TDCi	81 - 100	04/05→09/12							
1.6	81	03/10→				24.9145-0004.2	399008		
1.8 Flexifuel	96	12/05→01/08				01/06→	24.9145-0004.2	399008	

FORD - FOCUS II Turnier (DA_, FFS, DS) 07/04→09/12

Bremskraftverstärker

1.4	59	07/04→09/12	05/07→ 02/11; + ABS / für Fahrzeuge ohne Bremsassistent	03.7760-2232.4	300266	ATE Ø 10" pneumatisch
			1.6	74	07/04→07/11	
1.6 TDCi	74 - 80	07/04→09/12	10/04→ 02/11; - ABS / für Fahrzeuge ohne Bremsassistent	03.7760-2332.4	300267	ATE Ø 10" pneumatisch
			1.6 Ti	85	07/04→09/12	
2.0	107	07/04→09/12	10/04→ 04/07; + ABS / für Fahrzeuge ohne Bremsassistent	03.7760-8103.4	300240	ATE Ø 10" pneumatisch
			2.0 TDCi	100	07/04→09/12	
			10/04→ 04/07; + ABS / für Fahrzeuge mit Bremsassistent	03.7863-0332.4	300203	ATE Ø 10" pneumatisch
			05/07→ 02/11; + ABS / für Fahrzeuge mit Bremsassistent	03.7863-3932.4	300288	ATE Ø 10" pneumatisch
1.6 LPG	85	10/09→09/12	→ 02/11; + ABS / für Fahrzeuge ohne Bremsassistent	03.7760-2232.4	300266	ATE Ø 10" pneumatisch
			1.6 TDCi	81	12/07→09/12	
2.0 LPG	107	06/08→07/11	→ 02/11; - ABS / für Fahrzeuge ohne Bremsassistent	03.7760-2332.4	300267	ATE Ø 10" pneumatisch
			2.0 TDCi	81	02/08→07/11	
			→ 02/11; + ABS / für Fahrzeuge mit Bremsassistent	03.7863-3932.4	300288	ATE Ø 10" pneumatisch
1.6 TDCi	66	07/04→09/12	05/07→ 02/11; + ABS / für Fahrzeuge ohne Bremsassistent	03.7760-2232.4	300266	ATE Ø 10" pneumatisch
			1.8 TDCi	85	07/04→09/12	
			01/05→ 02/11; - ABS / für Fahrzeuge ohne Bremsassistent	03.7760-2332.4	300267	ATE Ø 10" pneumatisch
			01/05→ 04/07; + ABS / für Fahrzeuge ohne Bremsassistent	03.7760-8103.4	300240	ATE Ø 10" pneumatisch
			01/05→ 04/07; + ABS / für Fahrzeuge mit Bremsassistent	03.7863-0332.4	300203	ATE Ø 10" pneumatisch
			05/07→ 02/11; + ABS / für Fahrzeuge mit Bremsassistent	03.7863-3932.4	300288	ATE Ø 10" pneumatisch
1.8	92	03/06→09/12	05/07→ 02/11; + ABS / für Fahrzeuge ohne Bremsassistent	03.7760-2232.4	300266	ATE Ø 10" pneumatisch
			1.8 Flexifuel	92	01/06→09/12	
			→ 02/11; - ABS / für Fahrzeuge ohne Bremsassistent	03.7760-2332.4	300267	ATE Ø 10" pneumatisch
			→ 04/07; + ABS / für Fahrzeuge ohne Bremsassistent	03.7760-8103.4	300240	ATE Ø 10" pneumatisch
			→ 04/07; + ABS / für Fahrzeuge mit Bremsassistent	03.7863-0332.4	300203	ATE Ø 10" pneumatisch
			05/07→ 02/11; + ABS / für Fahrzeuge mit Bremsassistent	03.7863-3932.4	300288	ATE Ø 10" pneumatisch
2.0 TDCi	98	07/04→01/08	05/07→; + ABS / für Fahrzeuge ohne Bremsassistent	03.7760-2232.4	300266	ATE Ø 10" pneumatisch
			10/04→; - ABS / für Fahrzeuge ohne Bremsassistent	03.7760-2332.4	300267	ATE Ø 10" pneumatisch
			10/04→ 04/07; + ABS / für Fahrzeuge ohne Bremsassistent	03.7760-8103.4	300240	ATE Ø 10" pneumatisch
			10/04→ 04/07; + ABS / für Fahrzeuge mit Bremsassistent	03.7863-0332.4	300203	ATE Ø 10" pneumatisch
			05/07→; + ABS / für Fahrzeuge mit Bremsassistent	03.7863-3932.4	300288	ATE Ø 10" pneumatisch

→

FORD - FOCUS II Turnier (DA, FFS, DS) 07/04→09/12

Hauptbremszylinder

1.4	59	07/04→09/12		10/04→ 04/07; + ABS	03.2123-3103.3	010781	ATE Ø 23,8
1.6	74	07/04→07/11					
1.6 TDCi	74 - 80	07/04→09/12		05/07→ 10/08; + ABS	03.2125-0483.3	010783	ATE Ø 25,4 ohne Bremsflüssigkeitsbehälter
1.6 Ti	85	07/04→09/12		11/08→ 02/11; + ABS	03.2125-0661.3	010917	ATE Ø 25,4
2.0	107	07/04→09/12		10/04→ 02/11; - ABS	24.2123-3041.3	011021	ATE Ø 23,8 ohne Bremsflüssigkeitsbehälter / ohne Druckregler
2.0 TDCi	100	07/04→09/12					
1.6 LPG	85	10/09→09/12		→ 02/11; + ABS	03.2125-0661.3	010917	ATE Ø 25,4
				→ 02/11; - ABS	24.2123-3041.3	011021	ATE Ø 23,8 ohne Bremsflüssigkeitsbehälter / ohne Druckregler
1.6 TDCi	66	07/04→09/12		01/05→ 04/07; + ABS	03.2123-3103.3	010781	ATE Ø 23,8
1.8 TDCi	85	07/04→09/12		05/07→ 10/08; + ABS	03.2125-0483.3	010783	ATE Ø 25,4 ohne Bremsflüssigkeitsbehälter
				11/08→ 02/11; + ABS	03.2125-0661.3	010917	ATE Ø 25,4
				01/05→ 02/11; - ABS	24.2123-3041.3	011021	ATE Ø 23,8 ohne Bremsflüssigkeitsbehälter / ohne Druckregler
1.6 TDCi	81	12/07→09/12		→ 10/08; + ABS	03.2125-0483.3	010783	ATE Ø 25,4 ohne Bremsflüssigkeitsbehälter
2.0 LPG	107	06/08→07/11					
2.0 TDCi	81	02/08→07/11		11/08→ 02/11; + ABS	03.2125-0661.3	010917	ATE Ø 25,4
				→ 02/11; - ABS	24.2123-3041.3	011021	ATE Ø 23,8 ohne Bremsflüssigkeitsbehälter / ohne Druckregler
1.8	92	03/06→09/12		→ 04/07; + ABS	03.2123-3103.3	010781	ATE Ø 23,8
1.8 Flexifuel	92	01/06→09/12		05/07→ 10/08; + ABS	03.2125-0483.3	010783	ATE Ø 25,4 ohne Bremsflüssigkeitsbehälter
				11/08→ 02/11; + ABS	03.2125-0661.3	010917	ATE Ø 25,4
				→ 02/11; - ABS	24.2123-3041.3	011021	ATE Ø 23,8 ohne Bremsflüssigkeitsbehälter / ohne Druckregler
2.0 TDCi	98	07/04→01/08		10/04→ 04/07; + ABS	03.2123-3103.3	010781	ATE Ø 23,8
				05/07→; + ABS	03.2125-0483.3	010783	ATE Ø 25,4 ohne Bremsflüssigkeitsbehälter
				10/04→; - ABS	24.2123-3041.3	011021	ATE Ø 23,8 ohne Bremsflüssigkeitsbehälter / ohne Druckregler













Hydraulikaggregat, Bremsanlage











1.4	59	07/04→09/12		10/04→ 02/11	24.9145-0004.2	399008	
1.6	74	07/04→07/11					
1.6 TDCi	74 - 80	07/04→09/12					
1.6 Ti	85	07/04→09/12					
2.0	107	07/04→09/12					
2.0 TDCi	100	07/04→09/12					
1.6 LPG	85	10/09→09/12		→ 02/11	24.9145-0004.2	399008	
1.6 TDCi	81	12/07→09/12					
1.8	92	03/06→09/12					
1.8 Flexifuel	92	01/06→09/12					
2.0 LPG	107	06/08→07/11					
2.0 TDCi	81	02/08→07/11					
1.6 TDCi	66	07/04→09/12		01/05→ 02/11	24.9145-0004.2	399008	
1.8 TDCi	85	07/04→09/12					
2.0 TDCi	98	07/04→01/08		10/04→	24.9145-0004.2	399008	











FORD - FOCUS III 07/10→02/20

Hauptbremszylinder













1.0 EcoBoost	74 - 103	02/12→02/20			03.4155-5451.3	010995	ATE Ø 25,4
1.5 EcoBoost	110 - 134	09/14→12/17					
1.5 TDCi	70 - 88	09/14→04/18					
1.5 TDCi ECONetic	77	09/14→12/17					
1.6 Flexifuel	110	07/13→02/20					
1.6 LPG	86 - 88	02/12→02/20					
1.6 TDCi ECONetic	77	05/12→07/15					
1.6 Ti	63 - 88	08/11→12/17					
2.0 ST	184	07/12→12/17					
2.0 TDCi	110	11/14→12/17					
2.0 TDCi ST	136	11/14→12/17					
1.6 EcoBoost	110 - 134	07/10→06/14		03/11→	03.4155-5451.3	010995	ATE Ø 25,4
1.6 Flexifuel	88	07/10→02/20					
1.6 TDCi	70 - 85	07/10→12/17					
→							















	kW			 	! #		
FORD - FOCUS III 07/10→02/20							
 Hauptbremszylinder							
1.6 Ti	77 - 92	07/10→02/20		03/11→		03.4155-5451.3 010995	ATE Ø 25,4
2.0 TDCi	85 - 120	07/10→06/14					
2.0	119	09/11→06/18				03.4155-5456.3 010996	ATE Ø 25,4
2.0 Ti-GDi	125	08/11→02/20					
2.3 RS AWD	257	07/15→12/17					
FORD - FOCUS III Kasten/Kombi 02/12→02/20							
 Hauptbremszylinder							
1.0 EcoBoost	74 - 92	02/12→02/20				03.4155-5451.3 010995	ATE Ø 25,4
1.5 EcoBoost	110 - 134	09/14→02/20					
1.5 TDCi	70 - 88	09/14→02/20					
1.5 TDCi ECONetic	77	09/14→02/20					
2.0 TDCi	110	11/14→02/20					
FORD - FOCUS III Kasten/Schrägheck 01/11→02/20							
 Hauptbremszylinder							
1.0 EcoBoost	74 - 92	02/12→12/17				03.4155-5451.3 010995	ATE Ø 25,4
1.5 EcoBoost	110 - 134	09/14→12/17					
1.5 TDCi	70 - 88	09/14→12/17					
1.5 TDCi ECONetic	77	09/14→12/17					
1.6 EcoBoost	110 - 134	11/11→06/14					
1.6 TDCi	85	02/12→12/17					
2.0 TDCi	110	11/14→12/17					
1.6 TDCi	70	01/11→12/17		03/11→		03.4155-5451.3 010995	ATE Ø 25,4
1.6 Ti	77	01/11→02/20					
2.0 TDCi	85 - 120	01/11→06/14					
FORD - FOCUS III Stufenheck 07/10→02/20							
 Hauptbremszylinder							
1.0 EcoBoost	74 - 103	02/12→02/20				03.4155-5451.3 010995	ATE Ø 25,4
1.5 EcoBoost	110 - 134	11/14→02/20					
1.5 TDCi	70 - 88	11/14→02/20					
1.5 TDCi ECONetic	77	11/14→02/20					
1.6 Flexifuel	110	07/13→02/20					
1.6 TDCi	77	05/12→07/15					
1.6 Ti	63	08/11→02/20					
2.0 TDCi	110	11/14→02/20					
1.6 EcoBoost	110 - 134	07/10→06/14		03/11→		03.4155-5451.3 010995	ATE Ø 25,4
1.6 Flexifuel	88	07/10→02/20					
1.6 TDCi	70 - 85	07/10→02/20					
1.6 Ti	77 - 92	07/10→02/20					
2.0 TDCi	85 - 120	07/10→06/14					
2.0 GDi	125	08/11→02/20				03.4155-5456.3 010996	ATE Ø 25,4
FORD - FOCUS III Turnier 07/10→02/20							
 Hauptbremszylinder							
1.0 EcoBoost	74 - 103	02/12→02/20				03.4155-5451.3 010995	ATE Ø 25,4
1.5 EcoBoost	110 - 134	09/14→02/20					
1.5 TDCi	70 - 88	09/14→02/20					
1.5 TDCi ECONetic	77	09/14→02/20					
1.6 Flexifuel	110	07/13→02/20					
1.6 LPG	86 - 88	02/12→02/20					
1.6 TDCi ECONetic	77	05/12→07/15					
1.6 Ti	63 - 88	08/11→02/20					
2.0 ST	184	07/12→02/20					
2.0 TDCi	110	11/14→02/20					
→							















	kw					! #		
FORD - FOCUS III Turnier 07/10→02/20								
 Hauptbremszylinder								
2.0 TDCi ST	136	11/14→02/20					03.4155-5451.3 010995	ATE Ø 25,4
1.6 EcoBoost	110 - 134	07/10→06/14		03/11→			03.4155-5451.3 010995	ATE Ø 25,4
1.6 Flexifuel	88	07/10→02/20						
1.6 TDCi	70 - 85	07/10→02/20						
1.6 Ti	77 - 92	07/10→02/20						
2.0 TDCi	85 - 120	07/10→06/14						
2.0 Ti-GDi	125	07/10→02/20		08/11→			03.4155-5456.3 010996	ATE Ø 25,4
FORD - FOCUS C-MAX (DM2) 10/03→03/07								
 Bremskraftverstärker								
1.6	74	10/03→03/07		09/06→; für Fahrzeuge ohne Bremsassistent			03.7760-2232.4 300266	ATE Ø 10" pneumatisch
1.6 TDCi	66 - 80	10/03→03/07		→ 08/06; für Fahrzeuge ohne Bremsassistent			03.7760-8103.4 300240	ATE Ø 10" pneumatisch
1.6 Ti	85	08/04→03/07		→ 08/06; für Fahrzeuge mit Bremsassistent			03.7863-0332.4 300203	ATE Ø 10" pneumatisch
1.8	88 - 92	10/03→03/07		→ 08/06; für Fahrzeuge mit Bremsassistent			03.7863-0332.4 300203	ATE Ø 10" pneumatisch
1.8 Flexifuel	92	01/06→03/07		09/06→; für Fahrzeuge mit Bremsassistent			03.7863-3932.4 300288	ATE Ø 10" pneumatisch
2.0 TDCi	98 - 100	10/03→03/07		09/06→; für Fahrzeuge mit Bremsassistent			03.7863-3932.4 300288	ATE Ø 10" pneumatisch
1.8 TDCi	85	01/05→03/07		09/06→; für Fahrzeuge ohne Bremsassistent			03.7760-2232.4 300266	ATE Ø 10" pneumatisch
				→ 08/06; für Fahrzeuge ohne Bremsassistent			03.7760-8103.4 300240	ATE Ø 10" pneumatisch
				08/06→; für Fahrzeuge mit Bremsassistent			03.7863-0332.4 300203	ATE Ø 10" pneumatisch
				→ 07/06; für Fahrzeuge mit Bremsassistent			03.7863-3932.4 300288	ATE Ø 10" pneumatisch
2.0	107	03/04→03/07		09/06→; für Fahrzeuge ohne Bremsassistent			03.7760-2232.4 300266	ATE Ø 10" pneumatisch
				04/04→ 08/06; für Fahrzeuge ohne Bremsassistent			03.7760-8103.4 300240	ATE Ø 10" pneumatisch
				04/04→ 08/06; für Fahrzeuge mit Bremsassistent			03.7863-0332.4 300203	ATE Ø 10" pneumatisch
				09/06→; für Fahrzeuge mit Bremsassistent			03.7863-3932.4 300288	ATE Ø 10" pneumatisch
 Hauptbremszylinder								
1.6	74	10/03→03/07					03.2123-3103.3 010781	ATE Ø 23,8
1.6 TDCi	66 - 80	10/03→03/07					03.2125-0483.3 010783	ATE Ø 25,4 ohne Bremsflüssigkeitsbehälter
1.6 Ti	85	08/04→03/07						
1.8	88 - 92	10/03→03/07						
1.8 Flexifuel	92	01/06→03/07						
1.8 TDCi	85	01/05→03/07						
2.0 TDCi	98 - 100	10/03→03/07						
2.0	107	03/04→03/07		04/04→			03.2123-3103.3 010781	ATE Ø 23,8
							03.2125-0483.3 010783	ATE Ø 25,4 ohne Bremsflüssigkeitsbehälter
Hydraulikaggregat, Bremsanlage								
1.6	74	10/03→03/07					24.9145-0004.2 399008	
1.6 TDCi	66 - 80	10/03→03/07						
1.6 Ti	85	08/04→03/07						
1.8	88 - 92	10/03→03/07						
1.8 Flexifuel	92	01/06→03/07						
1.8 TDCi	85	01/05→03/07						
2.0 TDCi	98 - 100	10/03→03/07						
2.0	107	03/04→03/07		04/04→			24.9145-0004.2 399008	
FORD - FUSION (JU_) 08/02→12/12								
 Bremskraftverstärker								
1.25	55	08/04→12/12		→ 09/12; für Fahrzeuge ohne Bremsassistent			03.7750-8732.4 300199	ATE Ø 9" pneumatisch
1.4	59	08/02→12/12		→ 09/12; für Fahrzeuge mit Bremsassistent			03.7853-2102.4 300201	ATE Ø 9" pneumatisch
1.4 LPG	59	01/10→12/12						
1.4 TDCi	50	08/02→12/12						
1.6 TDCi	66	11/04→12/12						
1.3	44	11/02→07/05		für Fahrzeuge ohne Bremsassistent			03.7750-8732.4 300199	ATE Ø 9" pneumatisch
→								













	kw					! #		
FORD - FUSION (JU_) 08/02→12/12								
 Bremskraftverstärker								
1.6	74	08/02→11/09		für Fahrzeuge mit Bremsassistent		03.7853-2102.4	300201	ATE Ø 9" pneumatisch
 Hauptbremszylinder								
1.25	55	08/04→12/12		→ 09/12; für Linkslenker; - ABS		03.4153-0015.3	011005	ATE Ø 23,8 ohne Bremsflüssigkeitsbehälter
1.4	59	08/02→12/12						
1.4 LPG	59	01/10→12/12		→ 09/12; für Linkslenker		03.4153-5287.4	010953	ATE Ø 23,8 mit Bremsflüssigkeitsbehälter
1.4 TDCi	50	08/02→12/12						
1.6 TDCi	66	11/04→12/12						
1.3	44	11/02→07/05		für Linkslenker; - ABS		03.4153-0015.3	011005	ATE Ø 23,8 ohne Bremsflüssigkeitsbehälter
1.6	74	08/02→11/09		für Linkslenker; - ABS		03.4153-0015.3	011005	ATE Ø 23,8 ohne Bremsflüssigkeitsbehälter
				für Linkslenker		03.4153-5287.4	010953	ATE Ø 23,8 mit Bremsflüssigkeitsbehälter
FORD - GALAXY I (WGR) 03/95→05/06								
 Bremskraftverstärker								
1.9 TDI	66	03/95→05/06		09/97→ 03/00; für Linkslenker; + ABS		03.7755-1902.4	300138	ATE Ø 9 / 8" pneumatisch
				04/00→ 04/06; für Rechtslenker; - ESP		03.7755-6302.4	300221	ATE Ø 9 / 8" pneumatisch
				04/00→ 10/02; für Linkslenker; - ESP		03.7755-6302.4	300221	ATE Ø 9 / 8" pneumatisch
				01/96→ 08/97; für Linkslenker		03.7760-3002.4	300120	ATE Ø 10" pneumatisch
				04/00→ 10/02; für Linkslenker; + ESP		03.7858-3302.4	300122	ATE Ø 9 / 8" pneumatisch
1.9 TDI	81	08/97→04/00		10/97→ 03/00; für Linkslenker; + ABS		03.7755-1902.4	300138	ATE Ø 9 / 8" pneumatisch
1.9 TDI	85	04/00→05/06		→ 10/02; für Linkslenker; - ESP		03.7755-6302.4	300221	ATE Ø 9 / 8" pneumatisch
2.3 16V	103	09/01→05/06		→ 04/06; für Rechtslenker; - ESP		03.7755-6302.4	300221	ATE Ø 9 / 8" pneumatisch
2.8 V6	150	04/00→05/06		→ 10/02; für Linkslenker; + ESP		03.7858-3302.4	300122	ATE Ø 9 / 8" pneumatisch
1.9 TDI	96	02/03→05/06		→ 04/06; für Rechtslenker; - ESP		03.7755-6302.4	300221	ATE Ø 9 / 8" pneumatisch
1.9 TDI	110	05/05→05/06		für Rechtslenker; - ESP		03.7755-6302.4	300221	ATE Ø 9 / 8" pneumatisch
2.0 i	85	11/95→05/06		09/97→ 03/00; für Linkslenker; + ABS		03.7755-1902.4	300138	ATE Ø 9 / 8" pneumatisch
2.3 16V	107	01/97→05/06		04/00→ 10/02; für Linkslenker; - ESP		03.7755-6302.4	300221	ATE Ø 9 / 8" pneumatisch
				04/00→ 04/06; für Rechtslenker; - ESP		03.7755-6302.4	300221	ATE Ø 9 / 8" pneumatisch
				→ 08/97; für Linkslenker		03.7760-3002.4	300120	ATE Ø 10" pneumatisch
				04/00→ 10/02; für Linkslenker; + ESP		03.7858-3302.4	300122	ATE Ø 9 / 8" pneumatisch
2.8 i V6	128	11/95→04/00		09/97→ 03/00; für Linkslenker; + ABS		03.7755-1902.4	300138	ATE Ø 9 / 8" pneumatisch
2.8 i V6 4x4	128	04/96→04/00		→ 08/97; für Linkslenker		03.7760-3002.4	300120	ATE Ø 10" pneumatisch
 Hauptbremszylinder								
1.9 TDI	66	03/95→05/06		01/96→ 08/97; + ABS		03.2123-1526.3	010477	Ø 23,8
				01/96→ 08/97; - ABS		03.2123-1548.3	010478	Ø 23,8
				09/97→ 03/00; + ABS		03.2125-0332.3	010952	Ø 25,4
				11/02→ 04/06; - ESP		03.2125-0332.3	010952	Ø 25,4
				04/00→ 10/02; - ESP		03.2125-0332.3	010952	Ø 25,4
				09/97→ 03/00; - ABS		03.2125-8404.3	010583	ATE Ø 25,4
				04/00→ 10/02; + ESP		03.2125-9604.3	010581	Ø 25,4
1.9 TDI	81	08/97→04/00		10/97→ 03/00; + ABS		03.2125-0332.3	010952	Ø 25,4
				10/97→ 03/00; - ABS		03.2125-8404.3	010583	ATE Ø 25,4
1.9 TDI	85	04/00→05/06		11/02→ 04/06; - ESP		03.2125-0332.3	010952	Ø 25,4
2.3 16V	103	09/01→05/06		→ 10/02; - ESP		03.2125-0332.3	010952	Ø 25,4
2.8 V6	150	04/00→05/06		→ 10/02; + ESP		03.2125-9604.3	010581	Ø 25,4
1.9 TDI	96	02/03→05/06		→ 04/06; - ESP		03.2125-0332.3	010952	Ø 25,4
1.9 TDI	110	05/05→05/06		- ESP		03.2125-0332.3	010952	Ø 25,4
2.0 i	85	11/95→05/06		→ 08/97; + ABS		03.2123-1526.3	010477	Ø 23,8
2.3 16V	107	01/97→05/06		→ 08/97; - ABS		03.2123-1548.3	010478	Ø 23,8
				09/97→ 03/00; + ABS		03.2125-0332.3	010952	Ø 25,4
				11/02→ 04/06; - ESP		03.2125-0332.3	010952	Ø 25,4
				04/00→ 10/02; - ESP		03.2125-0332.3	010952	Ø 25,4
				09/97→ 03/00; - ABS		03.2125-8404.3	010583	ATE Ø 25,4
				04/00→ 10/02; + ESP		03.2125-9604.3	010581	Ø 25,4
2.8 i V6	128	11/95→04/00		→ 08/97; + ABS		03.2123-1526.3	010477	Ø 23,8
2.8 i V6 4x4	128	04/96→04/00		→ 08/97; - ABS		03.2123-1548.3	010478	Ø 23,8
				09/97→ 03/00; + ABS		03.2125-0332.3	010952	Ø 25,4
				09/97→ 03/00; - ABS		03.2125-8404.3	010583	ATE Ø 25,4
→								

















	kw			 	! #		
FORD - GALAXY I (WGR) 03/95→05/06							
Verschlussschraube, Hauptbremszylinder							
1.9 TDI	66	03/95→05/06		01/96→08/97; - ABS		03.3517-5100.1 390326	
2.0 i	85	11/95→05/06		→08/97; - ABS		03.3517-5100.1 390326	
2.3 16V	107	01/97→05/06					
2.8 i V6	128	11/95→04/00					
2.8 i V6 4x4	128	04/96→04/00					
FORD - GALAXY II (WA6) 05/06→06/15							
 Bremskraftverstärker							
1.6 EcoBoost	118	11/10→06/15		02/11→		03.7755-1432.4 300300	ATE Ø 9 / 8" pneumatisch
1.6 TDCi	85	02/11→06/15				03.7755-1432.4 300300	ATE Ø 9 / 8" pneumatisch
1.8 TDCi	74 - 92	05/06→06/15					
2.0	107	05/06→06/15					
2.0 EcoBoost	146 - 149	03/10→06/15					
2.0 Flexifuel	107	05/06→06/15					
2.0 TDCi	85 - 120	05/06→06/15					
2.2 TDCi	147	11/10→06/15					
2.3	118	09/07→06/15					
2.2 TDCi	129	03/08→12/12		04/08→		03.7755-1432.4 300300	ATE Ø 9 / 8" pneumatisch
FORD - GALAXY MK I VAN (WGR) 03/95→05/06							
 Bremskraftverstärker							
2.3	103	11/02→03/06		für Rechtslenker; - ESP		03.7755-6302.4 300221	ATE Ø 9 / 8" pneumatisch
 Hauptbremszylinder							
2.3	103	11/02→03/06		- ESP		03.2125-0332.3 010952	Ø 25,4
FORD - GALAXY MK II VAN (WA6) 05/06→06/15							
 Bremskraftverstärker							
2.0	107	05/06→06/15				03.7755-1432.4 300300	ATE Ø 9 / 8" pneumatisch
2.0 EcoBoost	149	03/10→06/15					
EcoBoost	118	02/11→06/15					
TDCi	85 - 147	05/06→06/15					
TDCi	85	01/07→06/15		02/11→		03.7755-1432.4 300300	ATE Ø 9 / 8" pneumatisch
FORD - GRAND C-MAX (DXA/CB7, DXA/CEU) 12/10→06/19							
 Hauptbremszylinder							
1.0 EcoBoost	74 - 92	10/12→06/19		für Linkslenker		03.4155-5456.3 010996	ATE Ø 25,4
1.5 EcoBoost	110 - 134	03/15→06/19					
1.5 TDCi	70 - 88	03/15→06/19					
1.6 EcoBoost	110 - 134	12/10→06/19					
1.6 TDCi	70 - 85	12/10→06/19					
1.6 Ti	63 - 92	12/10→06/19					
2.0 TDCi	85 - 120	12/10→06/19		für Linkslenker		03.4155-5451.3 010995	ATE Ø 25,4
						03.4155-5456.3 010996	ATE Ø 25,4
2.0 TDCi	100 - 125	02/11→06/19		für Linkslenker		03.4155-5451.3 010995	ATE Ø 25,4
FORD - GRAND C-MAX Van 12/10→06/19							
 Hauptbremszylinder							
1.0 EcoBoost	74 - 92	10/12→06/19		für Linkslenker		03.4155-5456.3 010996	ATE Ø 25,4
1.5 EcoBoost	110	03/15→06/19					
1.5 TDCi	88	03/15→06/19					
1.6 EcoBoost	110 - 134	12/10→06/19					
1.6 TDCi	70 - 85	12/10→06/19					
1.6 Ti	92	12/10→12/14					
2.0 TDCi	103 - 120	12/10→06/19		für Linkslenker		03.4155-5451.3 010995	ATE Ø 25,4
2.0 TDCi	85	02/11→06/19				03.4155-5456.3 010996	ATE Ø 25,4
2.0 TDCi	110 - 125	03/15→06/19		für Linkslenker		03.4155-5451.3 010995	ATE Ø 25,4













	kw					! #		
FORD - KA 01/08→								
 Hauptbremszylinder								
1.0	46 - 48	10/08→				24.4120-1706.3	011072	Ø 20,6 ohne Bremsflüssigkeitsbehälter
FORD - KA (RU8) 10/08→05/16								
 Hauptbremszylinder								
1.2 1.3 TDCi	51 55	10/08→05/16 10/08→05/16				24.4120-1706.3	011072	Ø 20,6 ohne Bremsflüssigkeitsbehälter
FORD - KUGA I 02/08→11/12								
 Bremskraftverstärker								
2.0 TDCi	100	03/08→11/12		04/08→; für Linkslenker		03.7755-3532.4	300290	ATE Ø 9 / 8" pneumatisch
2.0 TDCi 4x4	100	03/08→11/12		04/08→; für Rechtslenker		03.7760-2232.4	300266	ATE Ø 10" pneumatisch
2.0 TDCi	103	03/10→11/12		für Linkslenker		03.7755-3532.4	300290	ATE Ø 9 / 8" pneumatisch
2.0 TDCi 4x4	103 - 120	03/10→11/12		für Rechtslenker		03.7760-2232.4	300266	ATE Ø 10" pneumatisch
2.5 4x4	147	02/08→11/12		für Linkslenker		03.7755-3532.4	300290	ATE Ø 9 / 8" pneumatisch
 Hauptbremszylinder								
2.0 TDCi	100	03/08→11/12		04/08→; für Rechtslenker; → 10/08		03.2125-0483.3	010783	ATE Ø 25,4 ohne Bremsflüssigkeitsbehälter
2.0 TDCi 4x4	100	03/08→11/12		11/08→; für Linkslenker		03.2125-0651.3	010935	ATE Ø 25,4
				11/08→; für Rechtslenker		03.2125-0661.3	010917	ATE Ø 25,4
2.0 TDCi	103	03/10→11/12		für Linkslenker		03.2125-0651.3	010935	ATE Ø 25,4
2.0 TDCi 4x4	103 - 120	03/10→11/12						
2.5 4x4	147	02/08→11/12						
Hydraulikaggregat, Bremsanlage								
2.0 TDCi	100	03/08→11/12		04/08→		24.9145-0004.2	399008	
2.0 TDCi 4x4	100	03/08→11/12						
2.0 TDCi	103	03/10→11/12				24.9145-0004.2	399008	
2.0 TDCi 4x4	103 - 120	03/10→11/12						
2.5 4x4	147	02/08→11/12						
FORD - KUGA I VAN 02/08→11/12								
 Bremskraftverstärker								
2.5	147	02/08→11/12		für Linkslenker		03.7755-3532.4	300290	ATE Ø 9 / 8" pneumatisch
TDCi	103	03/10→11/12		für Linkslenker		03.7755-3532.4	300290	ATE Ø 9 / 8" pneumatisch
TDCi 4x4	103 - 120	03/10→11/12		für Rechtslenker		03.7760-2232.4	300266	ATE Ø 10" pneumatisch
 Hauptbremszylinder								
2.5	147	02/08→11/12		für Linkslenker		03.2125-0651.3	010935	ATE Ø 25,4
TDCi	103	03/10→11/12						
TDCi 4x4	103 - 120	03/10→11/12						
Hydraulikaggregat, Bremsanlage								
2.5	147	02/08→11/12				24.9145-0004.2	399008	
TDCi	103	03/10→11/12						
TDCi 4x4	103 - 120	03/10→11/12						
FORD - KUGA II (DM2) 05/12→								
 Hauptbremszylinder								
1.5 EcoBoost	88 - 134	09/14→				03.4155-5456.3	010996	ATE Ø 25,4
1.5 EcoBoost 4x4	110 - 134	09/14→12/19						
1.6 EcoBoost	110	03/13→09/14						
1.6 EcoBoost 4x4	110 - 134	10/12→12/19						
2.0 TDCi	85 - 110	03/13→12/19						
2.0 TDCi 4x4	100 - 132	03/13→12/19						
2.5	110 - 125	09/13→						
1.5 EcoBoost 4x4	129	08/18→06/19		für Linkslenker		03.4155-5456.3	010996	ATE Ø 25,4
1.5 EcoBoost E85	110	02/19→11/19						
2.0 EcoBoost 4x4	169	03/19→12/19						
2.0 4x4	179	03/13→06/16		für Linkslenker; für Fahrzeuge mit Start-Stopp-Funktion		03.4155-5456.3	010996	ATE Ø 25,4
2.0 EcoBoost 4x4	178	08/17→06/18						

	kw			 	! #		
FORD - KUGA II VAN 05/12→12/19							
 Hauptbremszylinder							
1.5 EcoBoost 1.5 EcoBoost 4x4	88 129	06/19→12/19 06/19→12/19		für Linkslenker		03.4155-5456.3 010996	ATE Ø 25,4
1.5 EcoBoost 1.5 EcoBoost 4x4 2.0 TDCi 2.0 TDCi 4x4	110 134 88 - 110 110 - 132	09/14→12/19 09/14→12/19 09/14→12/19 09/14→12/19				03.4155-5456.3 010996	ATE Ø 25,4
FORD - MONDEO II (BAP) 08/96→09/00							
 Hauptbremszylinder							
1.6 i 1.8 i 1.8 TD 2.0 i 2.5 24V	66 85 66 96 125	08/96→09/00 08/96→09/00 08/96→09/00 08/96→09/00 08/96→09/00		10/96→; + ABS		24.2125-1709.3 010499	Ø 25,4
1.6 i 16V 2.5 24V 2.5 ST 200	70 125 151	05/98→09/00 06/00→09/00 05/99→09/00		+ ABS		24.2125-1709.3 010499	Ø 25,4
FORD - MONDEO II Stufenheck (BFP) 08/96→09/00							
 Hauptbremszylinder							
1.6 i 1.8 i 1.8 TD 2.0 i 2.5 24V	66 85 66 96 125	08/96→09/00 08/96→09/00 08/96→09/00 08/96→09/00 08/96→09/00		10/96→; + ABS		24.2125-1709.3 010499	Ø 25,4
1.6 i 16V 2.5 24V 2.5 ST 200	70 125 151	05/98→09/00 06/00→09/00 05/99→09/00		+ ABS		24.2125-1709.3 010499	Ø 25,4
FORD - MONDEO II Turnier (BNP) 08/96→09/00							
 Hauptbremszylinder							
1.6 i 1.8 i 1.8 TD 2.0 i 2.5 24V	66 85 66 96 125	08/96→09/00 08/96→09/00 08/96→09/00 08/96→09/00 08/96→09/00		10/96→; + ABS		24.2125-1709.3 010499	Ø 25,4
1.6 i 16V 2.5 24V 2.5 ST 200	70 125 151	05/98→09/00 10/99→09/00 05/99→09/00		+ ABS		24.2125-1709.3 010499	Ø 25,4
 Bremskraftregler							
1.6 i 1.8 i 1.8 TD 2.0 i 1.6 i 16V	66 85 66 96 70	08/96→09/00 08/96→09/00 08/96→09/00 08/96→09/00 05/98→09/00		10/96→; - ABS - ABS	2 2	03.6043-1953.3 320201	ATE 3/45 2x ATE 3/45 2x
FORD - MONDEO III (B5Y) 10/00→03/07							
 Hauptbremszylinder							
1.8 16V 1.8 SCi 2.0 16V 2.0 16V DI / TDDi / TDCi 2.0 16V TDDi / TDCi 2.0 DI 2.0 TDCi 2.2 TDCi 2.5 V6 24V 3.0 V6 24V ST220	81 - 92 96 107 66 85 92 96 110 - 114 125 150 166	10/00→03/07 06/03→03/07 10/00→03/07 10/00→03/07 10/00→03/07 10/00→03/07 10/01→03/07 09/04→03/07 10/00→03/07 09/04→03/07 04/02→03/07		für Fahrzeuge ohne Bremsassistent		24.2123-1779.3 011078	Ø 23,8 ohne Bremsflüssigkeitsbehälter
FORD - MONDEO III Stufenheck (B4Y) 10/00→09/07							
 Hauptbremszylinder							
1.8 16V 1.8 SCi 2.0 16V 2.0 16V DI / TDDi / TDCi 2.0 16V TDDi / TDCi 2.0 TDCi 2.2 TDCi →	81 - 92 96 107 66 85 96 110 - 114	10/00→03/07 06/03→03/07 10/00→03/07 10/00→03/07 10/00→03/07 10/01→03/07 09/04→03/07 114		für Fahrzeuge ohne Bremsassistent		24.2123-1779.3 011078	Ø 23,8 ohne Bremsflüssigkeitsbehälter

















	kw			 	! #		
FORD - MONDEO III Stufenheck (B4Y) 10/00→09/07							
 Hauptbremszylinder							
2.5 V6	125	10/00→03/07		für Fahrzeuge ohne Bremsassistent		24.2123-1779.3 011078	Ø 23,8 ohne Bremsflüssigkeitsbehälter
2.5 V6 24V	125	10/00→03/07					
3.0 V6 24V	150	09/04→03/07					
ST220	166	04/02→03/07					
2.0 DI	92	10/00→03/07		10/01→; für Fahrzeuge ohne Bremsassistent		24.2123-1779.3 011078	Ø 23,8 ohne Bremsflüssigkeitsbehälter
FORD - MONDEO III Turnier (BWY) 10/00→03/07							
 Hauptbremszylinder							
1.8 16V	81 - 92	10/00→03/07		für Fahrzeuge ohne Bremsassistent		24.2123-1779.3 011078	Ø 23,8 ohne Bremsflüssigkeitsbehälter
1.8 SCi	96	06/03→03/07					
2.0 16V	107	10/00→03/07					
2.0 16V DI / TDDi / TDCi	66	10/00→03/07					
2.0 16V TDDi / TDCi	85	10/00→03/07					
2.0 TDCi	96	10/01→03/07					
2.2 TDCi	110 - 114	09/04→03/07					
2.5 V6 24V	125	10/00→03/07					
3.0 V6 24V	150	09/04→03/07					
ST220	166	04/02→03/07					
FORD - MONDEO IV (BA7) 03/07→01/15							
 Bremskraftverstärker							
1.6 EcoBoost	118	02/11→01/15		→ 09/14		03.7755-1432.4 300300	ATE Ø 9 / 8" pneumatisch
1.6 TDCi	85	02/11→01/15					
1.6 Ti	88	07/10→01/15					
1.8 TDCi	92	06/07→01/15					
2.0 EcoBoost	176	07/10→01/15					
2.0 Flexifuel	107	03/09→01/15					
2.0 LPG	107	07/09→01/15					
2.0 SCTi	149	03/10→01/15					
2.0 TDCi	85 - 120	03/07→01/15					
2.3	118	07/07→01/15					
1.6 Ti	81 - 92	03/07→01/15		04/07→ 09/14		03.7755-1432.4 300300	ATE Ø 9 / 8" pneumatisch
1.8 TDCi	74	03/07→01/15					
2.0	107	03/07→01/15					
2.0 TDCi	96 - 103	03/07→01/15					
2.5	162	03/07→01/15					
2.2 TDCi	129	03/08→10/10		04/08→		03.7755-1432.4 300300	ATE Ø 9 / 8" pneumatisch
2.2 TDCi	147	07/10→01/15		11/10→ 09/14		03.7755-1432.4 300300	ATE Ø 9 / 8" pneumatisch
FORD - MONDEO IV Stufenheck (BA7) 03/07→01/15							
 Bremskraftverstärker							
1.6 EcoBoost	118	11/10→01/15		02/11→ 09/14		03.7755-1432.4 300300	ATE Ø 9 / 8" pneumatisch
1.6 TDCi	85	12/10→01/15					
1.6 Ti	81 - 92	03/07→01/15		04/07→ 09/14		03.7755-1432.4 300300	ATE Ø 9 / 8" pneumatisch
1.8 TDCi	74	03/07→01/15					
2.0	107	03/07→01/15					
2.0 TDCi	96 - 103	03/07→01/15					
2.5	162	03/07→01/15					
1.6 Ti	88	03/10→01/15		→ 09/14		03.7755-1432.4 300300	ATE Ø 9 / 8" pneumatisch
1.8 TDCi	92	06/07→01/15					
2.0 Flexifuel	107	03/09→01/15					
2.0 LPG	107	07/09→01/15					
2.0 SCTi	149	03/10→01/15					
2.0 TDCi	85 - 120	11/07→01/15					
2.3	118	07/07→01/15					
2.0 EcoBoost	176	03/10→09/14				03.7755-1432.4 300300	ATE Ø 9 / 8" pneumatisch
2.0 TDCi	100	08/08→12/14					
2.2 TDCi	129	03/08→10/10		04/08→		03.7755-1432.4 300300	ATE Ø 9 / 8" pneumatisch
2.2 TDCi	147	10/10→01/15		11/10→ 09/14		03.7755-1432.4 300300	ATE Ø 9 / 8" pneumatisch
FORD - MONDEO IV Turnier (BA7) 03/07→01/15							
 Bremskraftverstärker							
1.6 EcoBoost	118	02/11→01/15		→ 09/14		03.7755-1432.4 300300	ATE Ø 9 / 8" pneumatisch
1.6 TDCi	85	02/11→01/15					
1.6 Ti	88	07/10→01/15					
2.0 EcoBoost	176	07/10→01/15					
2.0 Flexifuel	107	03/09→01/15					
→							































	kw			 	! #		
FORD - MONDEO IV Turnier (BA7) 03/07→01/15							
 Bremskraftverstärker							
2.0 LPG 2.0 SCTi 2.0 TDCi 2.3	107 149 85 - 120 118	07/09→01/15 03/10→01/15 03/07→01/15 07/07→01/15		→ 09/14		03.7755-1432.4 300300	ATE Ø 9 / 8" pneumatisch
1.6 Ti 1.8 TDCi 2.0 TDCi 2.5 1.8 TDCi	81 - 92 74 96 162 92	03/07→12/12 03/07→12/12 03/07→12/12 03/07→12/12 06/07→12/12		04/07→		03.7755-1432.4 300300	ATE Ø 9 / 8" pneumatisch
2.0 2.0 TDCi 2.2 TDCi 2.2 TDCi	107 103 129 147	03/07→01/15 03/07→01/15 03/08→10/10 07/10→01/15		04/07→ 09/14 04/08→ 11/10→ 09/14		03.7755-1432.4 300300	ATE Ø 9 / 8" pneumatisch
FORD - MONDEO IV Van 03/07→01/15							
 Bremskraftverstärker							
1.6 EcoBoost 1.6 TDCi 2.0 EcoBoost 2.0 TDCi 2.2 TDCi 2.0 2.0 TDCi	118 85 149 - 176 85 - 120 147 107 103	11/10→09/14 03/13→09/14 03/10→09/14 11/07→09/14 03/13→09/14 03/07→09/14 03/07→09/14		04/07→		03.7755-1432.4 300300	ATE Ø 9 / 8" pneumatisch
FORD - PUMA (EC_) 03/97→06/02							
 Hauptbremszylinder							
1.4 16V 1.6 16V 1.7 16V	66 76 92	11/97→10/00 08/00→06/02 03/97→06/02		02/00→; + ABS → 12/01; + ABS 02/00→ 12/01; + ABS		03.2123-2243.3 010748	ATE Ø 23,8
FORD - RANGER (ET) 01/05→07/12							
 Hauptbremszylinder							
2.2 2.5 TDCi 4x4 3.0 TDCi 4x4 2.5 TDi 2.5 TDi 4x4 3.0 TDCi	68 105 115 105 80 115	06/07→01/09 05/06→07/12 05/06→07/12 05/06→07/12 06/07→07/12 05/06→07/12		04/10→ 10/11		24.2125-1747.3 011029	Ø 25,4
FORD - S-MAX (WA6) 05/06→12/14							
 Bremskraftverstärker							
1.6 EcoBoost 1.6 TDCi 1.8 TDCi 2.0 2.0 EcoBoost 2.0 Flexifuel 2.0 TDCi 2.2 TDCi 2.3 2.5 ST 2.2 TDCi	118 85 74 - 92 107 146 - 176 107 85 - 120 147 118 162 129	02/11→12/14 02/11→12/14 05/06→12/14 05/06→12/14 03/10→12/14 05/06→12/14 05/06→12/14 07/10→12/14 07/07→12/14 05/06→12/14 03/08→12/12		04/08→		03.7755-1432.4 300300	ATE Ø 9 / 8" pneumatisch
FORD - S-MAX VAN (WA6) 05/06→12/14							
 Bremskraftverstärker							
1.6 2.0 2.0 EcoBoost 2.0 TDCi	118 107 149 - 176 85 - 120	02/11→12/14 03/10→12/14 03/10→12/14 01/07→12/14				03.7755-1432.4 300300	ATE Ø 9 / 8" pneumatisch
FORD - TOURNEO CONNECT / GRAND TOURNEO CONNECT V408 Großraumlimousi 09/13→							
 Hauptbremszylinder							
1.0 EcoBoost 1.6 EcoBoost	74 110	11/13→12/22 11/13→12/22		für verkürzten Radstand für verlängerten Radstand		03.4155-5451.3 010995 03.4155-5456.3 010996	ATE Ø 25,4 ATE Ø 25,4















	kw					! #		
FORD - TOURNEO CONNECT / GRAND TOURNEO CONNECT V408 Großraumlimousi 09/13→								
 Hauptbremszylinder								
1.6 TDCi	55 - 85	09/13→12/22		für verkürzten Radstand		03.4155-5451.3	010995	ATE Ø 25,4
				für verlängerten Radstand		03.4155-5456.3	010996	ATE Ø 25,4
FORD - TOURNEO COURIER B460 Großraumlimousine 02/14→								
 Hauptbremszylinder								
1.0 EcoBoost 1.5 TDCi	74 55	02/14→12/23 02/14→12/23		für Linkslenker; + ABS		24.4120-1710.3	011082	Ø 20,6 ohne Bremsflüssigkeitsbehälter
				für Linkslenker; - ABS		24.4120-1711.3	011093	Ø 20,6 ohne Bremsflüssigkeitsbehälter
1.5 EcoBlue 1.5 TDCi	74 70	04/18→12/23 05/15→12/23		+ ABS		24.4120-1710.3	011082	Ø 20,6 ohne Bremsflüssigkeitsbehälter
				für Linkslenker; - ABS		24.4120-1711.3	011093	Ø 20,6 ohne Bremsflüssigkeitsbehälter
1.6 TDCi	70	02/14→12/23		für Rechtslenker; + ABS		24.4120-1710.3	011082	Ø 20,6 ohne Bremsflüssigkeitsbehälter
				für Linkslenker; - ABS		24.4120-1711.3	011093	Ø 20,6 ohne Bremsflüssigkeitsbehälter
FORD - TOURNEO CUSTOM V362 Bus (F3) 09/12→								
 Hauptbremszylinder								
2.0 EcoBlue 2.2 TDCi	77 - 96 74 - 114	12/15→12/23 09/12→12/15				24.4128-1700.3	011161	BOS Ø 28,6 ohne Bremsflüssigkeitsbehälter
FORD - TRANSIT Bus (E_) 06/94→07/00								
 Hauptbremszylinder								
2.0 2.5 DI	84 51 - 56	08/94→03/00 07/94→03/00		→ 03/97; - ABS		24.2123-1724.3	010566	BDX Ø 23,8
				04/97→; + ABS		24.2123-1742.3	010671	Ø 23,8
2.5 TD	63 - 74	07/94→03/00		04/97→; - ABS		24.2123-1749.3	010713	Ø 23,8
2.0 CNG	84	06/94→03/00		07/94→ 03/97; - ABS		24.2123-1724.3	010566	BDX Ø 23,8
				→ 03/97; - ABS		24.2123-1724.3	010566	BDX Ø 23,8
				04/97→; + ABS		24.2123-1742.3	010671	Ø 23,8
				04/97→; - ABS		24.2123-1749.3	010713	Ø 23,8
2.5 DI	85	08/97→03/00		+ ABS		24.2123-1742.3	010671	Ø 23,8
				- ABS		24.2123-1749.3	010713	Ø 23,8
2.5 TD	55	08/94→06/00		→ 03/97; - ABS		24.2123-1724.3	010566	BDX Ø 23,8
				04/97→ 03/00; + ABS		24.2123-1742.3	010671	Ø 23,8
				04/97→ 03/00; - ABS		24.2123-1749.3	010713	Ø 23,8
FORD - TRANSIT Bus (FD_ , FB_ , FS_ , FZ_ , FC_) 01/00→05/06								
 Hauptbremszylinder								
2.0 DI 2.0 TDCi 2.3 16V RWD 2.4 DI 2.4 DI RWD 2.4 TDCi 2.4 TDE	55 - 74 92 107 66 55 - 88 101 85 - 92	08/00→05/06 08/02→05/06 08/00→05/06 01/00→05/06 01/00→05/06 03/04→05/06 07/01→05/06		- ABS + ABS		24.2125-1721.3 24.2125-1722.3	010673 010674	Ø 25,4 ohne Bremsflüssigkeitsbehälter Ø 25,4 ohne Bremsflüssigkeitsbehälter
FORD - TRANSIT Bus (FD_ , FB_ , FS_ , FZ_ , FC_) 04/06→12/14								
 Hauptbremszylinder								
2.2 TDCi	63	04/06→08/14		05/06→; + ABS		24.4125-1708.3	011055	Ø 25,4 ohne Bremsflüssigkeitsbehälter
				05/06→; - ABS		24.4125-1710.3	011091	Ø 25,4 ohne Bremsflüssigkeitsbehälter
2.2 TDCi 2.2 TDCi RWD 2.4 TDCi 2.4 TDCi 4x4 3.2 TDCi	74 - 103 74 - 114 74 - 103 103 147	04/06→08/14 09/11→12/14 04/06→08/14 11/06→08/14 02/08→08/14		+ ABS - ABS		24.4125-1708.3 24.4125-1710.3	011055 011091	Ø 25,4 ohne Bremsflüssigkeitsbehälter Ø 25,4 ohne Bremsflüssigkeitsbehälter





























	kw					! #		
FORD - TRANSIT CONNECT Großraumlimousine 02/13→								
 Hauptbremszylinder								
1.6 TDCi	55 - 85	02/13→		für verkürzten Radstand		03.4155-5451.3	010995	ATE Ø 25,4
				für verlängerten Radstand		03.4155-5456.3	010996	ATE Ø 25,4
FORD - TRANSIT CONNECT V408 Kasten/Großraumlimousine 02/13→								
 Hauptbremszylinder								
1.0 EcoBoost	74	02/13→		09/13→; für verkürzten Radstand		03.4155-5451.3	010995	ATE Ø 25,4
				09/13→; für verlängerten Radstand		03.4155-5456.3	010996	ATE Ø 25,4
1.6 EcoBoost	110	11/13→		für verkürzten Radstand		03.4155-5451.3	010995	ATE Ø 25,4
1.6 TDCi	55 - 85	02/13→		für verlängerten Radstand		03.4155-5456.3	010996	ATE Ø 25,4
FORD - TRANSIT COURIER B460 Großraumlimousine 02/14→								
 Hauptbremszylinder								
1.0 EcoBoost	74	02/14→12/23		+ ABS		24.4120-1710.3	011082	Ø 20,6 ohne Bremsflüssigkeitsbehälter
1.5 EcoBlue	74	04/18→12/23						
1.5 TDCi	55 - 70	02/14→12/23		für Linkslenker; - ABS		24.4120-1711.3	011093	Ø 20,6 ohne Bremsflüssigkeitsbehälter
1.6 TDCi	70	02/14→12/23						
FORD - TRANSIT COURIER B460 Kasten/Großraumlimousine 02/14→								
 Hauptbremszylinder								
1.0 EcoBoost	74	02/14→12/23		+ ABS		24.4120-1710.3	011082	Ø 20,6 ohne Bremsflüssigkeitsbehälter
1.5 EcoBlue	74	04/18→12/23						
1.5 TDCi	55 - 70	02/14→12/23		für Linkslenker; - ABS		24.4120-1711.3	011093	Ø 20,6 ohne Bremsflüssigkeitsbehälter
1.6 TDCi	70	02/14→12/23						
FORD - TRANSIT CUSTOM V362 Bus (F3) 04/12→								
 Hauptbremszylinder								
2.0 EcoBlue	77 - 96	12/15→12/23				24.4128-1700.3	011161	BOS Ø 28,6 ohne Bremsflüssigkeitsbehälter
2.2 TDCi	74 - 114	09/12→12/15						
FORD - TRANSIT CUSTOM V362 Kasten (FY, FZ) 09/12→								
 Hauptbremszylinder								
2.0 EcoBlue	77 - 96	12/15→12/23				24.4128-1700.3	011161	BOS Ø 28,6 ohne Bremsflüssigkeitsbehälter
2.2 TDCi	74 - 114	09/12→12/23						
FORD - TRANSIT Kasten (E_) 06/94→12/00								
 Hauptbremszylinder								
2.0	84	06/94→03/00		→ 03/97; - ABS		24.2123-1724.3	010566	BDX Ø 23,8
2.5 DI	51 - 56	06/94→03/00		04/97→; + ABS		24.2123-1742.3	010671	Ø 23,8
2.5 TD	63	06/94→03/00		04/97→; - ABS		24.2123-1749.3	010713	Ø 23,8
2.5 TDI	74	06/94→03/00						
2.5 DI	85	05/99→03/00		+ ABS		24.2123-1742.3	010671	Ø 23,8
2.5 TD	55	06/94→03/00		- ABS		24.2123-1749.3	010713	Ø 23,8
FORD - TRANSIT Kasten (FA_) 01/00→05/06								
 Hauptbremszylinder								
2.0 DI	55 - 74	08/00→05/06		- ABS		24.2125-1721.3	010673	Ø 25,4 ohne Bremsflüssigkeitsbehälter
2.0 TDCi	92	08/02→05/06		+ ABS		24.2125-1722.3	010674	Ø 25,4 ohne Bremsflüssigkeitsbehälter
2.3	105	03/01→03/06						
2.3 16V RWD	107	04/01→05/06						
2.3 BiFuel	105	03/01→03/06						
2.4 DI	66	01/00→05/06						
2.4 DI RWD	55 - 88	01/00→05/06						
2.4 TD	55	08/00→08/03						
2.4 TDCi	101	03/04→05/06						
2.4 TDE	85 - 92	07/01→05/06						
FORD - TRANSIT Kasten (FA_) 04/06→12/14								
 Hauptbremszylinder								
2.2 TDCi	63 - 103	04/06→08/14		+ ABS		24.4125-1708.3	011055	Ø 25,4 ohne Bremsflüssigkeitsbehälter
2.2 TDCi 4x4 →	92	10/11→08/14						















	kw					! #		
FORD - TRANSIT Kasten (FA_) 04/06→12/14								
 Hauptbremszylinder								
2.2 TDCi RWD	74 - 114	09/11→12/14		- ABS			24.4125-1710.3 011091	Ø 25,4 ohne Bremsflüssigkeitsbehälter
2.3 16V CNG RWD	100	04/06→08/14						
2.3 16V LPG RWD	107	04/06→08/14						
2.3 16V RWD	107	04/06→08/14						
2.4 TDCi 4x4	103	11/06→08/14						
2.4 TDCi RWD	74 - 103	04/06→08/14						
3.2 TDCi RWD	147	09/07→08/14						
FORD - TRANSIT Pritsche/Fahrgestell (E_) 08/94→07/00								
 Hauptbremszylinder								
2.0	84	08/94→03/00		→ 03/97; - ABS			24.2123-1724.3 010566	BDX Ø 23,8
2.5 DI	51 - 56	08/94→03/00		04/97→; + ABS			24.2123-1742.3 010671	Ø 23,8
2.5 TD	63 - 74	08/94→03/00		04/97→; - ABS			24.2123-1749.3 010713	Ø 23,8
2.5 DI	85	05/99→03/00		+ ABS			24.2123-1742.3 010671	Ø 23,8
				- ABS			24.2123-1749.3 010713	Ø 23,8
FORD - TRANSIT Pritsche/Fahrgestell (FM_ , FN_ , FF_) 04/06→12/14								
 Hauptbremszylinder								
2.2 TDCi	63 - 103	04/06→08/14		+ ABS			24.4125-1708.3 011055	Ø 25,4 ohne Bremsflüssigkeitsbehälter
2.2 TDCi 4x4	92	10/11→08/14						
2.2 TDCi RWD	74 - 114	10/11→08/14		- ABS			24.4125-1710.3 011091	Ø 25,4 ohne Bremsflüssigkeitsbehälter
2.3 16V CNG RWD	100	04/06→08/14						
2.3 16V LPG RWD	107	04/06→08/14						
2.3 16V RWD	107	04/06→08/14						
2.4 TDCi 4x4	103	11/06→08/14						
2.4 TDCi RWD	74 - 103	04/06→08/14						
3.2 TDCi RWD	147	09/07→08/14						
FORD - TRANSIT Pritsche/Fahrgestell (FM_ , FN_) 01/00→05/06								
 Hauptbremszylinder								
2.0 DI	55 - 74	08/00→05/06		- ABS			24.2125-1721.3 010673	Ø 25,4 ohne Bremsflüssigkeitsbehälter
2.0 TDCi	92	08/02→05/06						
2.3 16V	107	04/01→05/06		+ ABS			24.2125-1722.3 010674	Ø 25,4 ohne Bremsflüssigkeitsbehälter
2.3 BiFuel	105	03/01→03/06						
2.4 DI	55 - 88	01/00→05/06						
2.4 TDCi	101	03/04→05/06						
2.4 TDE	85 - 92	07/01→05/06						
FORD - TRANSIT TOURNEO Bus 07/06→08/14								
 Hauptbremszylinder								
2.2	92	10/11→08/14		+ ABS			24.4125-1708.3 011055	Ø 25,4 ohne Bremsflüssigkeitsbehälter
2.2 TDCi	81 - 103	07/06→08/14						
				- ABS			24.4125-1710.3 011091	Ø 25,4 ohne Bremsflüssigkeitsbehälter
FORD - TRANSIT TOURNEO Bus 08/94→12/00								
 Hauptbremszylinder								
2.0	84	11/94→12/00		09/95→ 03/97; - ABS			24.2123-1724.3 010566	BDX Ø 23,8
				04/97→ 03/00; + ABS			24.2123-1742.3 010671	Ø 23,8
				04/97→ 03/00; - ABS			24.2123-1749.3 010713	Ø 23,8
2.4 D	55	08/94→06/00		→ 03/97; - ABS			24.2123-1724.3 010566	BDX Ø 23,8
2.5 DI	51 - 56	11/94→12/00		04/97→ 03/00; + ABS			24.2123-1742.3 010671	Ø 23,8
				04/97→ 03/00; - ABS			24.2123-1749.3 010713	Ø 23,8
2.5 TD	63	11/94→12/00		01/95→ 03/97; - ABS			24.2123-1724.3 010566	BDX Ø 23,8
				04/97→ 03/00; + ABS			24.2123-1742.3 010671	Ø 23,8
				04/97→ 03/00; - ABS			24.2123-1749.3 010713	Ø 23,8
2.5 TD	74	04/98→12/00		→ 03/00; + ABS			24.2123-1742.3 010671	Ø 23,8
				→ 03/00; - ABS			24.2123-1749.3 010713	Ø 23,8













	kw					! #		
FORD - TRANSIT TOURNEO Bus (FC_) 06/00→03/06								
 Hauptbremszylinder								
2.0	55 - 92	06/00→03/06		- ABS		24.2125-1721.3	010673	Ø 25,4 ohne Bremsflüssigkeitsbehälter
				+ ABS		24.2125-1722.3	010674	Ø 25,4 ohne Bremsflüssigkeitsbehälter
HONDA - ACCORD VII (CL, CN) 01/03→09/12								
 Hauptbremszylinder								
2.0	110	01/06→03/08		für Linkslenker		24.2120-1752.3	010928	ATE Ø 20,6 mit Bremsflüssigkeitsbehälter
2.4	113	09/06→05/08						
2.0	114	02/03→05/08		01/06→; für Linkslenker		24.2120-1752.3	010928	ATE Ø 20,6 mit Bremsflüssigkeitsbehälter
2.4	140	02/03→05/08						
2.4 i 16V	115	02/03→05/08						
2.0 All-wheel Drive	114	02/03→05/08		01/06→		24.2120-1752.3	010928	ATE Ø 20,6 mit Bremsflüssigkeitsbehälter
2.2 i-CTDi	103	01/04→05/08						
HONDA - ACCORD VII Tourer (CM, CN) 11/02→05/08								
 Hauptbremszylinder								
2.0	114	04/03→05/08		01/06→		24.2120-1752.3	010928	ATE Ø 20,6 mit Bremsflüssigkeitsbehälter
2.2 i-CTDi	103	01/04→05/08						
2.4	140	04/03→05/08						
2.4 Vtec T	147	09/03→05/08						
HONDA - CIVIC VI Coupe (EJ, EM1) 03/96→12/00								
 Hauptbremszylinder								
1.6 i	77	03/96→03/00		→ 12/98; - ABS		24.2120-1751.3	010909	Ø 20,6
HONDA - CIVIC VI Hatchback (EJ, EK) 10/95→03/01								
 Hauptbremszylinder								
1.4 i	55	11/95→02/01		→ 01/01; - ABS; für Linkslenker		24.2120-1751.3	010909	Ø 20,6
1.4 i S	66	11/95→02/01						
1.4 LPG	66	01/97→02/01						
HONDA - CIVIC VI Stufenheck (EJ, EK, SO) 06/95→03/01								
 Hauptbremszylinder								
1.4 i	66	11/95→02/01		→ 01/01; - ABS; für Linkslenker		24.2120-1751.3	010909	Ø 20,6
HONDA - CIVIC VIII Hatchback (FN, FK) 09/05→12/12								
 Hauptbremszylinder								
1.4	61	09/05→09/08		für Linkslenker		24.2120-1759.3	011083	Ø 20,6 ohne Bremsflüssigkeitsbehälter
1.8	103	09/05→12/11						
2.2 CTDi	103	09/05→12/11						
Type R	148	09/06→01/12						
HYUNDAI - ATOS (MX) 01/97→07/15								
 Hauptbremszylinder								
1.1	43	08/03→12/08		→ 08/08; + ABS		24.2120-1767.3	011004	Ø 20,6 ohne Bremsflüssigkeitsbehälter
1.1	45	06/03→12/10		→ 01/07; + ABS; für Linkslenker		24.2120-1767.3	011004	Ø 20,6 ohne Bremsflüssigkeitsbehälter
1.1	46	08/03→12/08		03/04→ 02/08; + ABS		24.2120-1767.3	011004	Ø 20,6 ohne Bremsflüssigkeitsbehälter
HYUNDAI - GETZ (TB) 06/01→01/11								
 Hauptbremszylinder								
1.1	46	09/02→09/05		→ 07/05; - ABS		24.2122-1761.3	010822	Ø 22,2
1.6	77	09/02→09/05		→ 07/05; + ABS		24.2122-1765.3	010839	Ø 22,2
1.1	49	09/05→06/09		→ 02/09; - ESP		24.2122-1765.3	010839	Ø 22,2
1.4 i	71	08/05→12/10						
1.5 CRDi	65	08/05→06/09						
1.5 CRDi GLS	81	08/05→06/09						
1.3	61 - 63	09/03→06/09		→ 04/05; - ABS		24.2122-1761.3	010822	Ø 22,2
1.5 i	73	03/03→09/05		→ 04/05; + ABS		24.2122-1765.3	010839	Ø 22,2
1.3 i	60	09/02→03/04		- ABS		24.2122-1761.3	010822	Ø 22,2
				+ ABS		24.2122-1765.3	010839	Ø 22,2
1.5 CRDi	60	03/03→09/05		→ 04/05; - ESP		24.2122-1765.3	010839	Ø 22,2
1.5 CRDi GLS	75	07/04→08/05		→ 07/05; - ESP		24.2122-1765.3	010839	Ø 22,2
1.6	78	06/05→06/09		08/05→; - ESP		24.2122-1765.3	010839	Ø 22,2













	kw			 	! #		
HYUNDAI - i10 I (PA) 10/07→05/18							
 Hauptbremszylinder							
1.2	64	01/11→05/18		für Linkslenker		24.4120-1713.3 011102	Ø 20,6 ohne Bremsflüssigkeitsbehälter
HYUNDAI - i10 II (BA, IA) 08/13→12/21							
 Hauptbremszylinder							
1.0	49	08/13→12/19		12/13→; für Linkslenker		24.4120-1713.3 011102	Ø 20,6 ohne Bremsflüssigkeitsbehälter
1.0 LPG	49 - 51	02/14→12/19		für Linkslenker		24.4120-1713.3 011102	Ø 20,6 ohne Bremsflüssigkeitsbehälter
1.2	64	12/13→12/19					
HYUNDAI - i10 II Stufenheck 12/13→							
 Hauptbremszylinder							
1.2	64	08/15→		für Linkslenker		24.4120-1713.3 011102	Ø 20,6 ohne Bremsflüssigkeitsbehälter
HYUNDAI - i30 (GD) 06/11→							
 Hauptbremszylinder							
1.4	73 - 74	12/11→12/16		für Linkslenker; + ABS / - ESP		24.4122-1724.3 011080	ATE Ø 22,2 ohne Bremsflüssigkeitsbehälter
1.4 CRDi	66	12/11→12/16					
1.4 LPG	73	01/13→12/14		für Rechtslenker; + ABS / - ESP		24.4122-1724.3 011080	ATE Ø 22,2 ohne Bremsflüssigkeitsbehälter
1.6	88 - 96	12/11→					
1.6 CRDi	94 - 100	11/11→12/16		für Linkslenker; + ABS / + ESP		24.4122-1732.3 011107	Ø 22,2 ohne Bremsflüssigkeitsbehälter
1.6 GDI	99	12/11→12/16					
1.6 T-GDI	137	01/15→					
1.8	110	01/12→					
1.6 CRDi	81	12/11→12/16		06/12→; für Linkslenker; + ABS / - ESP		24.4122-1724.3 011080	ATE Ø 22,2 ohne Bremsflüssigkeitsbehälter
				für Rechtslenker; + ABS / - ESP		24.4122-1724.3 011080	ATE Ø 22,2 ohne Bremsflüssigkeitsbehälter
				06/12→; für Linkslenker; + ABS / + ESP		24.4122-1732.3 011107	Ø 22,2 ohne Bremsflüssigkeitsbehälter
HYUNDAI - i30 Coupe 05/13→							
 Hauptbremszylinder							
1.4	73 - 74	05/13→		für Linkslenker; + ABS / - ESP		24.4122-1724.3 011080	ATE Ø 22,2 ohne Bremsflüssigkeitsbehälter
1.6 CRDi	81 - 100	05/13→		für Rechtslenker; + ABS / - ESP		24.4122-1724.3 011080	ATE Ø 22,2 ohne Bremsflüssigkeitsbehälter
1.6 GDI	99	05/13→					
1.6 T-GDI	137	01/15→		für Linkslenker; + ABS / + ESP		24.4122-1732.3 011107	Ø 22,2 ohne Bremsflüssigkeitsbehälter
1.4 CRDi	66	05/13→05/17		für Linkslenker; - ESP		24.4122-1724.3 011080	ATE Ø 22,2 ohne Bremsflüssigkeitsbehälter
				für Rechtslenker; - ESP		24.4122-1724.3 011080	ATE Ø 22,2 ohne Bremsflüssigkeitsbehälter
				für Linkslenker; + ESP		24.4122-1732.3 011107	Ø 22,2 ohne Bremsflüssigkeitsbehälter
HYUNDAI - i30 Hatchback Van (GDE) 06/12→							
 Hauptbremszylinder							
1.4 MPI	74	05/15→05/17		für Linkslenker; + ABS / - ESP		24.4122-1724.3 011080	ATE Ø 22,2 ohne Bremsflüssigkeitsbehälter
1.6 CRDi	81	05/15→					
1.6 GDI	99	05/15→		für Rechtslenker; + ABS / - ESP		24.4122-1724.3 011080	ATE Ø 22,2 ohne Bremsflüssigkeitsbehälter
				für Linkslenker; + ABS / + ESP		24.4122-1732.3 011107	Ø 22,2 ohne Bremsflüssigkeitsbehälter
HYUNDAI - i30 Kombi (GD) 06/12→							
 Hauptbremszylinder							
1.4	73 - 74	06/12→05/17		für Linkslenker; - ESP		24.4122-1724.3 011080	ATE Ø 22,2 ohne Bremsflüssigkeitsbehälter
1.4 CRDi	66	06/12→05/17					
1.6	88 - 95	06/12→		für Rechtslenker; - ESP		24.4122-1724.3 011080	ATE Ø 22,2 ohne Bremsflüssigkeitsbehälter
1.6 CRDi	81 - 100	06/12→		für Linkslenker; + ESP		24.4122-1732.3 011107	Ø 22,2 ohne Bremsflüssigkeitsbehälter
1.6 GDI	99	06/12→					













	kW			 	! #		
HYUNDAI - i30 Kombi Van (GDE, GD) 06/12→							
 Hauptbremszylinder							
1.4 MPI	74	05/15→05/17		für Linkslenker; - ESP		24.4122-1724.3 011080	ATE Ø 22,2 ohne Bremsflüssigkeitsbehälter
				für Rechtslenker; - ESP		24.4122-1724.3 011080	ATE Ø 22,2 ohne Bremsflüssigkeitsbehälter
				für Linkslenker; + ESP		24.4122-1732.3 011107	Ø 22,2 ohne Bremsflüssigkeitsbehälter
1.6 CRDI 1.6 GDI	81 99	05/15→ 05/15→		für Linkslenker; für Fahrzeuge ohne Start-Stopp-Funktion		24.4122-1724.3 011080	ATE Ø 22,2 ohne Bremsflüssigkeitsbehälter
				für Linkslenker; für Fahrzeuge mit Start-Stopp-Funktion		24.4122-1732.3 011107	Ø 22,2 ohne Bremsflüssigkeitsbehälter
HYUNDAI - i40 I (VF) 03/12→05/19							
 Hauptbremszylinder							
1.6 CRDi 1.6 GDI 1.7 CRDi	85 - 100 99	07/18→05/19 03/12→05/19 03/12→05/19		für Linkslenker		24.4123-1737.3 011119	Ø 23,8 ohne Bremsflüssigkeitsbehälter
1.7 CRDi 2.0 GDi 2.0 GDI	103 - 104 121	10/12→05/19 12/14→05/19					
2.0 GDI 2.0 CVVT	130 - 131 110 - 130	03/12→05/19 03/12→05/19		für Linkslenker; - RU		24.4123-1737.3 011119	Ø 23,8 ohne Bremsflüssigkeitsbehälter
HYUNDAI - i40 I CW (VF) 07/11→05/19							
 Hauptbremszylinder							
1.6 CRDi 1.6 GDI 1.7 CRDi	85 - 100 99	07/18→05/19 07/11→05/19 07/11→05/19		für Linkslenker		24.4123-1737.3 011119	Ø 23,8 ohne Bremsflüssigkeitsbehälter
2.0 CVVT 2.0 GDi 2.0 GDI	121 - 130 121 130	07/11→05/19 12/14→05/19 07/11→05/19					
2.0 CVVT	110	10/12→05/19		für Linkslenker; - RU		24.4123-1737.3 011119	Ø 23,8 ohne Bremsflüssigkeitsbehälter
HYUNDAI - i40 I Kombi Van (VF) 07/11→05/19							
 Hauptbremszylinder							
1.7 CRDi	85	05/15→05/19		für Linkslenker		24.4123-1737.3 011119	Ø 23,8 ohne Bremsflüssigkeitsbehälter
HYUNDAI - ix20 (JC) 11/10→07/19							
 Hauptbremszylinder							
1.4 1.4 CRDi	66 57 - 66	11/10→07/19 11/10→07/19		+ ESP		24.4122-1725.3 011087	Ø 22,2 ohne Bremsflüssigkeitsbehälter
1.4 LPG 1.6 1.6 CRDi	66 92 85 -	11/10→07/19 11/10→07/19 06/11→07/19		- ESP		24.4122-1736.3 011129	Ø 22,2 ohne Bremsflüssigkeitsbehälter
1.6 LPG 1.4	94 74	11/10→07/19 11/10→07/19		für Linkslenker; + ESP		24.4122-1725.3 011087	Ø 22,2 ohne Bremsflüssigkeitsbehälter
				für Linkslenker; - ESP		24.4122-1736.3 011129	Ø 22,2 ohne Bremsflüssigkeitsbehälter
HYUNDAI - ix35 (LM, EL, ELH) 08/09→10/16							
 Hauptbremszylinder							
1.6 1.7 CRDi 2.0	99 85 113 -	11/10→12/15 11/10→12/15 01/10→12/15		+ ESP; für Linkslenker		24.4122-1723.3 011086	Ø 22,2 ohne Bremsflüssigkeitsbehälter
2.0 4WD 2.0 CRDi 2.0 CRDi 4WD	122 113 - 120 100 - 135 100 - 135	01/10→12/15 08/09→12/15 01/10→12/15					
2.0 CRDi 4WD 2.0 CVVT →	110	08/09→12/15					



















	kw					! #		
HYUNDAI - ix35 (LM, EL, ELH) 08/09→10/16								
 Hauptbremszylinder								
2.0 CVVT 4WD	110 - 122	08/09→12/15		+ ESP; für Linkslenker		24.4122-1723.3	011086	Ø 22,2 ohne Bremsflüssigkeitsbehälter
2.0 CVVT AWD	110	08/09→07/13						
2.0 GDi	122	08/13→12/15						
2.0 GDi 4WD	122	08/13→12/15						
2.4 DCVVT-I 4WD	128	07/10→12/13						
2.4 4WD	129 - 130	01/10→12/15		für Linkslenker; für Fahrzeuge mit Bremsassistent		24.4122-1723.3	011086	Ø 22,2 ohne Bremsflüssigkeitsbehälter
HYUNDAI - ix35 Van 08/09→12/15								
 Hauptbremszylinder								
CRDi	85 - 100	08/09→12/15		für Linkslenker; + ESP		24.4122-1723.3	011086	Ø 22,2 ohne Bremsflüssigkeitsbehälter
CRDi 4WD	100	08/09→12/15						
GDi	99	05/15→12/15						
HYUNDAI - MATRIX (FC) 06/01→08/10								
 Hauptbremszylinder								
1.5 CRDi	60	10/01→08/10		→ 07/03; - ABS		24.2123-1762.3	010823	Ø 23,8
1.6	66 - 76	06/01→08/10						
1.8	90	06/01→08/10		→ 07/03		24.2123-1762.3	010823	Ø 23,8
HYUNDAI - TUCSON (TL, TLE) 05/15→05/23								
 Hauptbremszylinder								
1.6 GDi	96 - 97	06/15→09/20		für Linkslenker; - ESP		24.4122-1724.3	011080	ATE Ø 22,2 ohne Bremsflüssigkeitsbehälter
1.6 T-GDi	130	06/15→05/23						
1.6 T-GDi All-wheel Drive	130	06/15→09/20		für Linkslenker; + ESP		24.4122-1732.3	011107	Ø 22,2 ohne Bremsflüssigkeitsbehälter
1.7 CRDi	85 - 104	06/15→09/20						
2.0	115	06/15→09/20						
2.0 CRDi	100	06/15→09/20		für Linkslenker; Fahrzeugproduktionsland Tschechische Republik; - ESP		24.4122-1724.3	011080	ATE Ø 22,2 ohne Bremsflüssigkeitsbehälter
2.0 CRDi All-wheel Drive	100 - 136	06/15→09/20		für Linkslenker; Fahrzeugproduktionsland Tschechische Republik; + ESP		24.4122-1732.3	011107	Ø 22,2 ohne Bremsflüssigkeitsbehälter
2.0 CVVT All-wheel Drive	110	06/15→09/20		- ESP		24.4122-1724.3	011080	ATE Ø 22,2 ohne Bremsflüssigkeitsbehälter
				+ ESP		24.4122-1732.3	011107	Ø 22,2 ohne Bremsflüssigkeitsbehälter
HYUNDAI - VELOSTER (FS) 03/11→12/17								
 Hauptbremszylinder								
1.6	94	06/11→12/17		für Linkslenker; + ESP		24.4122-1732.3	011107	Ø 22,2 ohne Bremsflüssigkeitsbehälter
1.6 GDi	95	10/11→12/17						
1.6 GDI	103	03/11→12/17						
1.6 MPI	97	04/11→12/17						
1.6 T-GDI	137 - 150	08/12→12/17						
JAGUAR - S-TYPE II (X200) 10/98→12/08								
 Bremskraftverstärker								
2.7 D	152	06/04→10/07				03.7745-6502.4	300296	ATE Ø 8" pneumatisch
Pedalwegsensoren, Bremspedal								
2.5 V6	147	04/02→10/07		02/03→		03.0655-0007.2	370007	ATE
4.2 V8	219	04/02→10/07						
2.7 D	152	06/04→10/07				03.0655-0007.2	370007	ATE
3.0	169	09/06→12/07						
3.0 V6	175	01/99→10/07		05/03→		03.0655-0007.2	370007	ATE
4.2 Supercharged R 4	298	11/01→12/08		08/03→		03.0655-0007.2	370007	ATE
2 V8	291	04/02→10/07						
 Hauptbremszylinder								
2.5 V6	147	04/02→10/07		N52048→; für Linkslenker; + ESP		24.4156-1051.3	011069	ATE Ø 27 ohne Bremsflüssigkeitsbehälter
2.7 D	152	06/04→10/07						
3.0	169	09/06→12/07						
3.0 V6	175	01/99→10/07						
4.0 V8	203 - 209	01/99→12/02						
4.2 Supercharged →	298	11/01→12/08						



















	kw			 	! #		
JAGUAR - S-TYPE II (X200) 10/98→12/08							
 Hauptbremszylinder							
4.2 V8 R 4 2 V8	219 291 291	04/02→10/07 04/02→10/07 04/02→10/07		N52048→; für Linkslenker; + ESP		24.4156-1051.3 011069	ATE Ø 27 ohne Bremsflüssigkeitsbehälter
JAGUAR - XF I (X250) 03/08→04/15							
 Bremskraftverstärker							
2.0 2.2 D 2.7 D 3.0 3.0 AWD 3.0 D 4.2 4.2 Kompressor 5.0	177 120 - 147 152 250 250 155 - 202 219 306 283	06/12→04/15 04/11→04/15 03/08→04/15 03/12→04/15 10/12→04/15 03/09→04/15 03/08→04/15 03/08→04/15 03/09→04/15				03.7745-6502.4 300296	ATE Ø 8" pneumatisch
 Hauptbremszylinder							
2.0 2.2 D 2.7 D 3.0 3.0 AWD 3.0 D 4.2 4.2 Kompressor 5.0 5.0 Kompressor 5.0 XFR-S	177 120 - 147 152 175 - 250 155 - 202 219 306 283 346 - 380 405	06/12→04/15 04/11→04/15 03/08→04/15 03/08→04/15 10/12→04/15 03/09→04/15 03/08→04/15 03/08→04/15 03/09→04/15 01/09→04/15 10/12→04/15		für Linkslenker		24.4156-1016.3 011068	ATE Ø 27
JAGUAR - XF SPORTBRAKE (X250) 09/12→12/15							
 Bremskraftverstärker							
2.0 T 2.2 D	177 120 - 147	08/13→12/15 09/12→04/14				03.7745-6502.4 300296	ATE Ø 8" pneumatisch
 Hauptbremszylinder							
2.0 T 2.2 D 3.0 D 5.0 XFR-S	177 120 - 147 177 - 202 405	08/13→12/15 09/12→04/14 09/12→04/14 02/13→04/14		für Linkslenker 02/14→; für Linkslenker		24.4156-1016.3 011068	ATE Ø 27
JAGUAR - XJ (X350, X358) 03/03→03/09							
Pedalwegsensord, Bremspedal							
3.0 3.6 4.2 R 4.2	175 - 179 190 219 - 224 291	05/03→03/09 05/03→03/09 05/03→03/09 03/03→03/09		für Rechtslenker 05/03→		03.0655-0007.2 370007	ATE
 Hauptbremszylinder							
D 2.7	152	10/05→03/09		H17287→; für Linkslenker G49701→ H17286; für Linkslenker		24.4156-1051.3 011069	ATE Ø 27 ohne Bremsflüssigkeitsbehälter
JAGUAR - XJ (X351) 10/09→							
 Hauptbremszylinder							
2.0 Ti4 3.0 SCV6 3.0 SCV6 AWD 3.0 SDV6 3.0 V6 5.0 SCV8 5.0 SCV8 R575 5.0 V8	177 250 250 202 - 221 175 346 - 405 423 283	05/12→12/19 03/12→12/19 10/12→12/19 10/09→12/19 01/11→12/19 10/09→12/19 06/17→12/19 10/09→12/19		für Linkslenker		24.4156-1076.3 011070	ATE Ø 27 ohne Bremsflüssigkeitsbehälter

















	kw					! #		
JAGUAR - XK II Cabriolet (X150) 03/06→07/14								
 Hauptbremszylinder								
3.6 4.2 XK8 4.2 XKR	190 219 306 - 313	10/07→07/14 03/06→07/14 03/06→07/14		B13391→; für Linkslenker		24.4156-1051.3	011069	ATE Ø 27 ohne Bremsflüssigkeitsbehälter
5.0 V8 5.0 XKR	283 375	01/09→07/14 01/09→07/14		→ B13390; für Linkslenker		24.4156-1051.3	011069	ATE Ø 27 ohne Bremsflüssigkeitsbehälter
4.2	291	09/07→12/09		für Linkslenker		24.4156-1051.3	011069	ATE Ø 27 ohne Bremsflüssigkeitsbehälter
5.0 XKR-S	405	01/11→07/14		B13391→; für Linkslenker		24.4156-1051.3	011069	ATE Ø 27 ohne Bremsflüssigkeitsbehälter
JAGUAR - XK II Coupe (X150) 03/06→12/14								
 Hauptbremszylinder								
3.6 4.2 XK8 4.2 XKR	190 219 291 - 313	07/07→07/14 03/06→07/14 03/06→07/14		B13391→; für Linkslenker		24.4156-1051.3	011069	ATE Ø 27 ohne Bremsflüssigkeitsbehälter
5.0 V8 5.0 XKR	283 375 - 390	01/09→07/14 01/09→07/14		→ B13390; für Linkslenker		24.4156-1051.3	011069	ATE Ø 27 ohne Bremsflüssigkeitsbehälter
5.0 XKR-S	405	01/11→07/14		B13391→; für Linkslenker		24.4156-1051.3	011069	ATE Ø 27 ohne Bremsflüssigkeitsbehälter
JAGUAR - XK 8 Convertible (X100) 03/96→12/06								
Pedalwegsensord, Bremspedal								
4.2 R 4.2	219 291	08/02→12/06 08/02→12/06		→ 07/05		03.0655-0007.2	370007	ATE
JAGUAR - XK 8 Coupe (X100) 03/96→12/06								
Pedalwegsensord, Bremspedal								
4.2 R 4.2	219 291	08/02→07/05 08/02→07/05				03.0655-0007.2	370007	ATE
JEEP - COMPASS (MP, M6, MV, M7) 01/16→								
 Hauptbremszylinder								
1.6 Multijet	96	04/21→				24.4123-1731.3	011094	Ø 23,8 ohne Bremsflüssigkeitsbehälter
JEEP - RENEGADE SUV (BU, B1, BV) 07/14→								
 Hauptbremszylinder								
1.0 T-GDi 1.3 T-GDi 1.3 T-GDi 4x4 1.4	88 110 132 100 - 103	08/18→ 08/18→ 08/18→ 07/14→		für Rechtslenker		24.4123-1731.3	011094	Ø 23,8 ohne Bremsflüssigkeitsbehälter
1.4 4x4 1.4 LPG 1.6 1.6 CRD	125 88 81 70 - 88	07/14→12/18 01/16→ 07/14→09/18 07/14→						
1.6 MultiJet 2.0 CRD 4x4	96 88 - 125	02/20→ 07/14→						
JEEP - RENEGADE VAN (BU, B1) 07/14→								
 Hauptbremszylinder								
1.4 1.4 4x4 1.6 E-torQ 1.6 MultiJet 2.0 MultiJet 4x4	103 125 81 88 103 - 125	07/14→ 07/14→ 07/14→09/18 07/14→ 07/14→		für Rechtslenker		24.4123-1731.3	011094	Ø 23,8 ohne Bremsflüssigkeitsbehälter
KIA - CEE'D (JD) 05/12→07/18								
 Hauptbremszylinder								
1.0 T-GDI 1.4 MPI 1.6 CRDi 136	74 - 88 74 100	07/15→07/18 04/15→07/18 07/15→07/18		für Linkslenker		24.4122-1732.3	011107	Ø 22,2 ohne Bremsflüssigkeitsbehälter
1.4 CRDi 90 1.4 CVVT	66 66 - 73	05/12→07/18 05/12→07/18		für Linkslenker; für Fahrzeuge mit Start-Stopp-Funktion; - ESP		24.4122-1724.3	011080	ATE Ø 22,2 ohne Bremsflüssigkeitsbehälter
1.4 LPG 1.6 CRDi 110 →	72 81	05/12→07/18 05/12→07/18		für Rechtslenker; - ESP		24.4122-1724.3	011080	ATE Ø 22,2 ohne Bremsflüssigkeitsbehälter















	kw			 	! #		
KIA - CEE'D (JD) 05/12→07/18							
 Hauptbremszylinder							
1.6 CRDi 128 1.6 GDI	94 99	05/12→07/18 05/12→07/18		für Linkslenker; + ESP		24.4122-1732.3 011107	Ø 22,2 ohne Bremsflüssigkeitsbehälter
1.6 CVVT	95	01/13→07/18		01/14→; für Linkslenker; + ESP		24.4122-1732.3 011107	Ø 22,2 ohne Bremsflüssigkeitsbehälter
1.6 CVVT	96	11/14→07/18		für Linkslenker; + ESP		24.4122-1732.3 011107	Ø 22,2 ohne Bremsflüssigkeitsbehälter
1.6 GT	150	06/13→07/18		07/13→; für Linkslenker; für Fahrzeuge ohne Start-Stopp-Funktion		24.4122-1724.3 011080	ATE Ø 22,2 ohne Bremsflüssigkeitsbehälter
				07/13→; für Rechtslenker; - ESP		24.4122-1724.3 011080	ATE Ø 22,2 ohne Bremsflüssigkeitsbehälter
				07/13→; für Linkslenker; für Fahrzeuge mit Start-Stopp-Funktion		24.4122-1732.3 011107	Ø 22,2 ohne Bremsflüssigkeitsbehälter
KIA - CEE'D Combi Van (JD) 07/12→07/18							
 Hauptbremszylinder							
1.0 T-GDI	74 - 88	04/15→07/18		für Linkslenker; - ESP		24.4122-1724.3 011080	ATE Ø 22,2 ohne Bremsflüssigkeitsbehälter
1.4 CRDi 1.4 CVVT 1.6 GDi	66 73 99	04/15→07/18 04/15→07/18 04/15→07/18		für Linkslenker; + ESP		24.4122-1732.3 011107	Ø 22,2 ohne Bremsflüssigkeitsbehälter
1.6 CRDi	94	07/12→07/18		für Linkslenker; - ESP		24.4122-1724.3 011080	ATE Ø 22,2 ohne Bremsflüssigkeitsbehälter
				für Rechtslenker; - ESP		24.4122-1724.3 011080	ATE Ø 22,2 ohne Bremsflüssigkeitsbehälter
				für Linkslenker; + ESP		24.4122-1732.3 011107	Ø 22,2 ohne Bremsflüssigkeitsbehälter
KIA - CEE'D Sportswagon (JD) 09/12→07/18							
 Hauptbremszylinder							
1.0 T-GDI	74 - 88	07/15→07/18		für Linkslenker		24.4122-1732.3 011107	Ø 22,2 ohne Bremsflüssigkeitsbehälter
1.4 MPI 1.6 CRDi 136	74 100	04/15→07/18 07/15→07/18					
1.4 CRDi 90 1.4 CVVT 1.4 LPG	66 73 72	09/12→07/18 09/12→07/15 01/13→07/18		für Linkslenker; für Fahrzeuge mit Start-Stopp-Funktion; - ESP		24.4122-1724.3 011080	ATE Ø 22,2 ohne Bremsflüssigkeitsbehälter
1.6 CRDi 110 1.6 CRDi 128 1.6 GDI	81 94 99	03/13→07/18 09/12→07/15 09/12→07/18		für Rechtslenker; - ESP		24.4122-1724.3 011080	ATE Ø 22,2 ohne Bremsflüssigkeitsbehälter
1.6 CVVT	95 - 96	11/14→07/18		für Linkslenker; + ESP		24.4122-1732.3 011107	Ø 22,2 ohne Bremsflüssigkeitsbehälter
KIA - PRO CEE'D (JD) 03/13→07/18							
 Hauptbremszylinder							
1.4 CRDi 90 1.4 CVVT 1.6 CRDi 110 1.6 CRDi 128 1.6 GDI 1.6 GT	66 74 81 94 99 150	03/13→07/18 07/13→07/18 03/13→07/18 03/13→07/15 03/13→07/18 06/13→07/18		für Linkslenker; für Fahrzeuge mit Start-Stopp-Funktion; - ESP		24.4122-1724.3 011080	ATE Ø 22,2 ohne Bremsflüssigkeitsbehälter
1.4 CVVT	73	03/13→07/15		für Rechtslenker; - ESP		24.4122-1724.3 011080	ATE Ø 22,2 ohne Bremsflüssigkeitsbehälter
				für Linkslenker; + ESP		24.4122-1732.3 011107	Ø 22,2 ohne Bremsflüssigkeitsbehälter
				für Linkslenker; für Fahrzeuge mit Start-Stopp-Funktion; - ESP		24.4122-1724.3 011080	ATE Ø 22,2 ohne Bremsflüssigkeitsbehälter
				für Rechtslenker; - ESP		24.4122-1724.3 011080	ATE Ø 22,2 ohne Bremsflüssigkeitsbehälter
1.4 MPI 1.6 CRDi 136	74 100	04/15→07/18 07/15→07/18		für Linkslenker; für Fahrzeuge ohne Start-Stopp-Funktion; + ESP		24.4122-1732.3 011107	Ø 22,2 ohne Bremsflüssigkeitsbehälter
				für Linkslenker; für Fahrzeuge mit Start-Stopp-Funktion; + ESP		24.4122-1732.3 011107	Ø 22,2 ohne Bremsflüssigkeitsbehälter
KIA - PRO CEE'D Hatchback Van (JD) 03/12→07/18							
 Hauptbremszylinder							
1.4 CRDi 1.6 GDI	66 99	05/15→07/18 04/15→07/18		für Linkslenker; für Fahrzeuge mit Start-Stopp-Funktion; - ESP		24.4122-1724.3 011080	ATE Ø 22,2 ohne Bremsflüssigkeitsbehälter
				für Rechtslenker; - ESP		24.4122-1724.3 011080	ATE Ø 22,2 ohne Bremsflüssigkeitsbehälter
				für Linkslenker; + ESP		24.4122-1732.3 011107	Ø 22,2 ohne Bremsflüssigkeitsbehälter
→							













	kw					! #		
KIA - PRO CEE'D Hatchback Van (JD) 03/12→07/18								
 Hauptbremszylinder								
1.4 CVVT 1.6 CRDi	73 94	05/12→07/18 10/12→07/18		03/13→; für Linkslenker; für Fahrzeuge mit Start-Stopp-Funktion; - ESP			24.4122-1724.3 011080	ATE Ø 22,2 ohne Bremsflüssigkeitsbehälter
				03/13→; für Rechtslenker; - ESP			24.4122-1724.3 011080	ATE Ø 22,2 ohne Bremsflüssigkeitsbehälter
				03/13→; für Linkslenker; + ESP			24.4122-1732.3 011107	Ø 22,2 ohne Bremsflüssigkeitsbehälter
1.4 MPI 1.6 CRDi	74 100	05/15→07/18 05/15→07/18		für Linkslenker			24.4122-1732.3 011107	Ø 22,2 ohne Bremsflüssigkeitsbehälter
KIA - SORENTO I (JC) 08/02→12/11								
 Hauptbremszylinder								
2.5 CRDi 4WD	103	08/02→03/11		→ 11/06; + ABS			24.2126-1702.3 010950	Ø 27
3.5 3.5 V6 4WD	143 143	09/02→12/06 08/02→12/11		→ 11/06; + ABS; Automatikgetriebe			24.2126-1702.3 010950	Ø 27
KIA - SPORTAGE III (SL) 09/09→07/17								
 Hauptbremszylinder								
1.6 GDI 2.0 CRDi 2.0 CRDi AWD 2.0 CVVT 2.0 CVVT AWD 2.0 CVVT Flex 2.0 GDI 2.0 GDI AWD 2.4 i AWD	99 100 100 110 - 122 110 - 122 131 122 - 194 122 130	06/10→12/15 07/10→12/15 07/10→12/15 06/10→12/15 06/10→12/15 02/12→12/16 09/13→12/15 02/14→12/15 08/10→12/15		+ ESP			24.4122-1723.3 011086	Ø 22,2 ohne Bremsflüssigkeitsbehälter
1.6 LPG	99	01/14→12/15		für Linkslenker; + ESP; - RU			24.4122-1723.3 011086	Ø 22,2 ohne Bremsflüssigkeitsbehälter
2.0 CVVT AWD 2.0 CVVT Flex AWD	110 - 113 131	01/14→12/15 01/12→12/16		für Linkslenker; Fahrzeugproduktionsland Slowakische Republik; + ESP			24.4122-1723.3 011086	Ø 22,2 ohne Bremsflüssigkeitsbehälter
				für Linkslenker; Fahrzeugproduktionsland Republik Korea (Südkorea)			24.4122-1723.3 011086	Ø 22,2 ohne Bremsflüssigkeitsbehälter
KIA - SPORTAGE IV (QL, QLE) 01/15→10/22								
 Hauptbremszylinder								
1.6 CRDi 1.6 CRDi AWD 1.6 CRDi Eco-Dynamics+ 1.6 CRDi Eco-Dynamics+ AWD 1.6 GDI 1.6 T-GDI 1.6 T-GDI AWD 1.7 CRDi	85 - 100 100 100 97 130 130 85 - 104	07/18→09/22 07/18→09/22 03/19→09/22 03/19→09/22 09/15→09/22 09/15→09/22 09/15→09/22 09/15→09/22 104		für Linkslenker			24.4122-1732.3 011107	Ø 22,2 ohne Bremsflüssigkeitsbehälter
1.6 LPG	93	07/20→09/22					24.4122-1732.3 011107	Ø 22,2 ohne Bremsflüssigkeitsbehälter
2.0 AWD 2.0 CRDi 2.0 CRDi AWD 2.0 CRDi Eco-Dynamics+ AWD	110 - 114 100 - 136 100 - 136 136	12/15→09/22 09/15→09/22 09/15→09/22 06/18→09/22		für Linkslenker; Fahrzeugproduktionsland Slowakische Republik			24.4122-1732.3 011107	Ø 22,2 ohne Bremsflüssigkeitsbehälter
KIA - SPORTAGE IV VAN (QL, QLE) 09/15→								
 Hauptbremszylinder								
1.6 CRDi Eco-Dynamics+ 1.6 CRDi Eco-Dynamics+ All-wheel Drive 1.6 T-GDI	100 100 130	03/19→ 03/19→ 05/18→		für Linkslenker			24.4122-1732.3 011107	Ø 22,2 ohne Bremsflüssigkeitsbehälter
LADA - 110 (2110) 01/95→12/12								
 Hauptbremszylinder								
1.5 1.5 16V →	54 - 57 70	01/95→12/05 01/95→12/05					24.2120-0803.3 010415	Ø 20,6













	kw					! #		
LADA - 110 (2110) 01/95→12/12								
 Hauptbremszylinder								
1.6	66	01/00→12/08					24.2120-0803.3 010415	Ø 20,6
2.0 i	110	08/96→07/00						
Wankel	88	06/97→09/04						
1.6	60	01/00→12/12		→ 08/07			24.2120-0803.3 010415	Ø 20,6
LADA - 111 (2111) 01/95→02/09								
 Hauptbremszylinder								
1.5	57	01/96→12/05					24.2120-0803.3 010415	Ø 20,6
1.5 16V	70	01/95→08/02						
1.6	60	09/04→02/09		01/05→ 12/08			24.2120-0803.3 010415	Ø 20,6
1.6	66	09/04→12/07		03/06→			24.2120-0803.3 010415	Ø 20,6
LADA - 112 (2112) 01/95→12/11								
 Hauptbremszylinder								
1.5	57	01/95→09/04					24.2120-0803.3 010415	Ø 20,6
1.5 16V	70	01/95→09/00						
1.6	66	03/06→12/08						
1.6	60	01/05→12/11		→ 12/08			24.2120-0803.3 010415	Ø 20,6
LADA - 1200-1600 01/70→12/05								
 Hauptbremszylinder								
1600 N/L	57	03/79→12/05		→ 06/85			24.2119-0831.3 010416	Ø 19
LADA - NOVA (2105) 05/81→04/12								
 Hauptbremszylinder								
1200 Junior/L	44	09/81→04/12		→ 12/96			24.2119-0832.3 010417	Ø 19
1300 Spezial/L	48	05/81→04/12						
1500 S	52	06/89→04/12						
1500 Special	55	03/85→04/12						
1600	56	01/88→10/01						
1700 i Classic	62	06/96→04/12						
LADA - NOVA Kombi (2104) 09/84→04/12								
 Hauptbremszylinder								
1500	49	08/94→04/12		→ 12/96			24.2119-0832.3 010417	Ø 19
1700	62	08/94→04/12						
LADA - SAMARA (2108, 2109, 2113, 2114) 09/84→12/13								
 Hauptbremszylinder								
1.5	56	04/96→12/13		→ 12/99			24.2120-0803.3 010415	Ø 20,6
1500	52	02/95→12/06						
1.5	59	08/03→12/06					24.2120-0803.3 010415	Ø 20,6
1.6	60	02/09→12/13						
LADA - SAMARA Schrägheck (2113, 2114) 03/97→12/13								
 Hauptbremszylinder								
1.5	53	08/03→12/13					24.2120-0803.3 010415	Ø 20,6
LADA - SAMARA Stufenheck (21099, 2115) 09/87→12/12								
 Hauptbremszylinder								
1500	52	11/94→12/06		→ 12/95			24.2120-0803.3 010415	Ø 20,6
LADA - TAIGA Geländewagen geschlossen (2121, 2131) 12/76→								
 Hauptbremszylinder								
1700 i	59	06/96→12/06					24.2119-0832.3 010417	Ø 19
1700 i 4x4	60	10/00→12/15						
1900 Diesel	55	01/99→12/06						
1700 i 4x4	61	05/04→					24.2120-0803.3 010415	Ø 20,6
LANCIA - DELTA III (844_) 08/08→08/14								
 Hauptbremszylinder								
1.4	88 - 110	09/08→08/14					24.4123-1710.3 010866	BOS Ø 23,8 ohne Bremsflüssigkeitsbehälter
1.4 16V	103	07/10→08/14						
1.4 Bifuel	88	07/11→08/14						
1.6 D Multijet	77 - 88	08/08→08/14						
1.8	147	01/09→08/14						
1.9 D Multijet	140	01/09→08/14						
→								











	kw					! #		
LANCIA - DELTA III (844_) 08/08→08/14								
 Hauptbremszylinder								
2.0 D Multijet	120 - 121	09/08→08/14					24.4123-1710.3 010866	BOS Ø 23,8 ohne Bremsflüssigkeitsbehälter
LANCIA - MUSA (350_) 10/04→09/12								
 Hauptbremszylinder								
1.3 D Multijet	51 - 66	10/04→09/12		→ 11/06; für Fahrzeuge ohne elektronische Fahrdynamikregelung			24.2123-1763.3 010842	Ø 23,8
1.4	57 - 70	10/04→09/12		12/06→			24.4123-1708.3 010859	BOS Ø 23,8
1.9 D Multijet	74	10/04→09/12						
1.3 D Multijet	70	03/09→09/12					24.4123-1708.3 010859	BOS Ø 23,8
1.4	66	10/07→09/12						
1.4 LPG	57	11/10→09/12						
1.6 D Multijet	85 - 88	07/08→09/12						
LANCIA - PHEDRA (179_) 09/02→11/10								
 Hauptbremszylinder								
2.0	100	09/02→11/10		→ 09/10			03.2122-2163.3 010800	ATE Ø 22,2
2.0 D Multijet	100	07/06→11/10						
2.0 JTD	79 - 88	09/02→11/10						
2.2 D Multijet	125	03/08→11/10						
2.2 JTD	94 - 120	09/02→11/10						
LANCIA - Y (840_) 11/95→09/03								
 Hauptbremszylinder								
1.1	40	11/95→09/03		05/97→ 12/98			24.2120-1710.3 010468	Ø 20,6
1.2	44	03/96→09/03		→ 07/03			24.2120-1710.3 010468	Ø 20,6
1.2 16V	59	10/00→09/03						
1.2 16V	63	04/97→09/03		05/97→ 09/00			24.2120-1710.3 010468	Ø 20,6
1.4 12V	55 - 59	03/96→09/03		→ 12/98			24.2120-1710.3 010468	Ø 20,6
 Bremskraftregler								
1.1	40	11/95→09/03		05/97→ 12/98; - ABS; 			24.6513-1705.3 320237	lastabhängig 2x
1.2	44	03/96→09/03		→ 07/03; - ABS; 			24.6513-1705.3 320237	lastabhängig 2x
1.2 16V	59	10/00→09/03						
1.2 16V	63	04/97→09/03		05/97→ 09/00; - ABS; 			24.6513-1705.3 320237	lastabhängig 2x
1.4 12V	55 - 59	03/96→09/03		→ 12/98; - ABS; 			24.6513-1705.3 320237	lastabhängig 2x
LANCIA - YPSILON (843_) 10/03→12/11								
 Hauptbremszylinder								
1.2	51 - 59	10/03→12/11		→ 06/11; für Fahrzeuge ohne elektronische Fahrdynamikregelung			24.2122-1762.3 010837	Ø 22,2
1.3 JTD	51	10/03→12/11						
1.4	57	02/06→12/11		→ 06/11; für Fahrzeuge mit elektronischer Fahrdynamikregelung			24.2122-1768.3 010853	Ø 22,2
1.4 16V	70	10/03→12/11						
1.4 LPG	57	11/10→12/11						
1.3 D Multijet	55 - 66	09/06→12/11		10/06→ 06/11; für Fahrzeuge ohne elektronische Fahrdynamikregelung			24.2122-1762.3 010837	Ø 22,2
				10/06→ 06/11; für Fahrzeuge mit elektronischer Fahrdynamikregelung			24.2122-1768.3 010853	Ø 22,2
1.3 D Multijet	77	05/07→12/11		07/07→ 06/11; für Fahrzeuge ohne elektronische Fahrdynamikregelung			24.2122-1762.3 010837	Ø 22,2
				07/07→ 06/11; für Fahrzeuge mit elektronischer Fahrdynamikregelung			24.2122-1768.3 010853	Ø 22,2
LANCIA - ZETA (22_) 05/95→10/03								
 Hauptbremszylinder								
2.0 16V	97	05/98→07/00		05/99→			24.2123-1733.3 010657	BOS Ø 23,8
2.0 Turbo	108	05/95→09/02						
2.0 16V	100	07/00→09/02					24.2123-1733.3 010657	BOS Ø 23,8
2.0 JTD	80	09/99→09/02						
2.0 JTD 16V	81	04/01→10/03						
LAND ROVER - DISCOVERY IV (L319) 09/09→12/18								
 Hauptbremszylinder								
2.7 TD 4x4	140	09/09→12/18					24.2026-1704.3 010989	TRW Ø 27 Ø2 20,6
3.0 4x4	250	08/13→12/18						
→								







	kw					! #		
LAND ROVER - DISCOVERY IV (L319) 09/09→12/18								
 Hauptbremszylinder								
3.0 SDV6 4x4 3.0 TD 4x4	188 155 - 200	11/09→12/18 09/09→12/18					24.2026-1704.3 010989	TRW Ø 27 Ø2 20,6
4.0 4x4 5.0 V8 4x4	160 276	09/09→12/18 09/09→12/18						
LAND ROVER - DISCOVERY IV VAN (L319) 09/09→12/17								
 Hauptbremszylinder								
3.0 TD 4x4	155 - 188	01/11→12/17					24.2026-1704.3 010989	TRW Ø 27 Ø2 20,6
LAND ROVER - FREELANDER 2 (L359) 10/06→12/15								
 Bremskraftverstärker								
2.0 Si4 4x4 2.2 eD4 2.2 SD4 4x4 2.2 TD4 4x4	177 110 140 110 - 118	10/11→10/14 08/10→10/14 08/10→10/14 10/06→10/14					03.7755-1232.4 300260	ATE Ø 9 / 8" pneumatisch
3.2 4x4	171	10/06→10/14						
 Hauptbremszylinder								
2.0 Si4 4x4 2.2 eD4 2.2 SD4 4x4 2.2 TD4 4x4	177 110 140 110 - 118	10/11→10/14 08/10→10/14 08/10→10/14 10/06→10/14					24.4156-1270.3 011058	ATE Ø 27 ohne Bremsflüssigkeitsbehälter
3.2 4x4	171	10/06→10/14						
LAND ROVER - FREELANDER 2 VAN (L359) 10/06→10/14								
 Bremskraftverstärker								
2.2 TD4 4x4	118	10/06→10/14					03.7755-1232.4 300260	ATE Ø 9 / 8" pneumatisch
 Hauptbremszylinder								
2.2 TD4 4x4	118	10/06→10/14					24.4156-1270.3 011058	ATE Ø 27 ohne Bremsflüssigkeitsbehälter
LAND ROVER - RANGE ROVER III (L322) 03/02→12/12								
 Hauptbremszylinder								
3.0 D 4x4 3.6 D 4x4 4.2 4x4 4.2 Supercharged 4x4 4.4 4x4	130 200 291 298 210 - 225	03/02→08/12 04/06→08/12 05/05→08/12 09/05→12/09 03/02→08/12	→ 5A999999				24.2026-1705.3 010992	TRW Ø 27 Ø2 20,6
LAND ROVER - RANGE ROVER EVOQUE (L538) 06/11→12/19								
 Hauptbremszylinder								
2.0 4x4	176	09/11→12/19					24.4156-1270.3 011058	ATE Ø 27 ohne Bremsflüssigkeitsbehälter
2.0 D 2.0 D 4x4	110 110 - 132	06/15→12/19 05/15→12/19	→ FH999999				24.4156-1270.3 011058	ATE Ø 27 ohne Bremsflüssigkeitsbehälter
2.2 D 2.2 D 4x4	110 110 - 140	06/11→12/19 06/11→12/19						
LAND ROVER - RANGE ROVER EVOQUE Cabriolet (L538) 11/15→12/19								
 Hauptbremszylinder								
2.0 4x4 2.0 D 4x4	177 110 - 132	11/15→12/19 11/15→12/19	→ FH999999				24.4156-1270.3 011058	ATE Ø 27 ohne Bremsflüssigkeitsbehälter
LAND ROVER - RANGE ROVER EVOQUE VAN (L538) 06/11→12/19								
 Hauptbremszylinder								
SD4 4x4 TD4 TD4 4x4	140 110 110	05/15→12/19 05/15→12/19 05/15→12/19	→ FH999999				24.4156-1270.3 011058	ATE Ø 27 ohne Bremsflüssigkeitsbehälter
Si4 4x4	177	09/13→12/19					24.4156-1270.3 011058	ATE Ø 27 ohne Bremsflüssigkeitsbehälter







	kw			 	! #		
LAND ROVER - RANGE ROVER SPORT I (L320) 02/05→03/13							
 Hauptbremszylinder							
3.0 D 4x4	155 - 188	09/09→03/13		für Linkslenker		24.2026-1704.3 010989	TRW Ø 27 Ø2 20,6
5.0 4x4	276 - 375	04/09→03/13					
3.6 D 4x4	200	04/06→03/13		AA000001→; für Linkslenker		24.2026-1704.3 010989	TRW Ø 27 Ø2 20,6
LEXUS - NX (_Z1_) 07/14→							
 Hauptbremszylinder							
200	110	11/14→		für Linkslenker		24.4122-1730.3 011105	Ø 22,2 ohne Bremsflüssigkeitsbehälter
200 AWD	110	11/14→					
200t	175	07/14→					
200t AWD	175	07/14→				24.4122-1730.3 011105	Ø 22,2 ohne Bremsflüssigkeitsbehälter
300	175	09/17→					
300 AWD	175	09/17→					
MAZDA - 2 (DY) 02/03→06/07							
 Hauptbremszylinder							
1.2	55	04/03→06/07		- ABS		03.4153-0015.3 011005	ATE Ø 23,8 ohne Bremsflüssigkeitsbehälter
1.3 L	67	04/03→06/07					
1.4	59	04/03→06/07					
1.4 CD	50	04/03→06/07		+ ABS		03.4153-5287.4 010953	ATE Ø 23,8 mit Bremsflüssigkeitsbehälter
1.6	74	02/03→06/07					
MAZDA - 3 (BK) 10/03→12/09							
 Hauptbremszylinder							
1.3	62	10/03→06/09		→ 03/06; für Linkslenker		03.2125-0483.3 010783	ATE Ø 25,4 ohne Bremsflüssigkeitsbehälter
1.6	77	10/03→06/09		→ 05/09; für Linkslenker		03.2125-0483.3 010783	ATE Ø 25,4 ohne Bremsflüssigkeitsbehälter
1.6 DI Turbo	80	06/04→06/09					
1.6 MZ-CD	66	06/06→12/09					
2.0	110	10/03→12/09					
2.0 MZR-CD	105	07/06→06/09					
2.0	104	10/03→06/06		für Linkslenker		03.2125-0483.3 010783	ATE Ø 25,4 ohne Bremsflüssigkeitsbehälter
2.3 MZR	115	10/03→03/09					
MAZDA - 3 (BL) 12/08→09/14							
 Hauptbremszylinder							
1.6 MZ-CD	80	12/08→05/13		06/09→; für Linkslenker		03.2125-0483.3 010783	ATE Ø 25,4 ohne Bremsflüssigkeitsbehälter
2.0 DISI	110	05/09→02/12					
2.0 MZR DISI	111	12/08→05/13					
2.2 MZR CD	110 - 136	01/09→10/13					
1.6 MZR	79	01/10→12/13		→ 11/13; für Linkslenker		03.2125-0483.3 010783	ATE Ø 25,4 ohne Bremsflüssigkeitsbehälter
2.0 MZR	108	04/09→09/14					
1.6 MZR	77	12/08→09/14		06/09→; für Linkslenker; → 11/13		03.2125-0483.3 010783	ATE Ø 25,4 ohne Bremsflüssigkeitsbehälter
2.0 MZR	110	01/09→09/14					
2.5	122	03/09→09/14					
1.6 MZR CD	85	09/10→05/13		11/10→; für Linkslenker		03.2125-0483.3 010783	ATE Ø 25,4 ohne Bremsflüssigkeitsbehälter
2.0	113	09/11→10/13		für Linkslenker		03.2125-0483.3 010783	ATE Ø 25,4 ohne Bremsflüssigkeitsbehälter
MAZDA - 3 Stufenheck (BK) 09/99→12/09							
 Hauptbremszylinder							
1.6	77	02/04→06/09		→ 05/09; für Linkslenker		03.2125-0483.3 010783	ATE Ø 25,4 ohne Bremsflüssigkeitsbehälter
1.6 DI Turbo	80	06/04→06/09					
2.0 MZR-CD	105	12/06→06/09					
2.0	104 - 110	10/03→12/09		für Linkslenker		03.2125-0483.3 010783	ATE Ø 25,4 ohne Bremsflüssigkeitsbehälter
2.3	118	03/04→03/09					
MAZDA - 3 Stufenheck (BL) 12/08→12/14							
 Hauptbremszylinder							
1.6 MZR	77	12/08→09/14		06/09→; für Linkslenker; → 11/13		03.2125-0483.3 010783	ATE Ø 25,4 ohne Bremsflüssigkeitsbehälter
2.0 MZR	110	03/09→09/14					
2.2 MZR CD	110	01/09→09/14					
1.6 MZR CD	80	12/08→05/13		06/09→; für Linkslenker		03.2125-0483.3 010783	ATE Ø 25,4 ohne Bremsflüssigkeitsbehälter
2.0 MZR DISI	111	02/09→05/13					
1.6 MZR CD	85	09/10→05/13		11/10→; für Linkslenker		03.2125-0483.3 010783	ATE Ø 25,4 ohne Bremsflüssigkeitsbehälter
2.0	113	09/11→09/14		für Linkslenker		03.2125-0483.3 010783	ATE Ø 25,4 ohne Bremsflüssigkeitsbehälter
2.2 MZR CD	136	06/09→05/13					











	kw			 	! #		
MAZDA - 6 Hatchback (GG) 08/02→12/08							
 Hauptbremszylinder							
1.8 2.0	88 104 - 108	08/02→08/07 08/02→08/07		→ 07/07; + ESP; Schaltgetriebe		24.2120-1756.3 010975	Ø 20,6 ohne Bremsflüssigkeitsbehälter
2.0 DI	89 - 105	08/02→08/07					
2.3	122	08/02→08/07					
3.0	162 - 164	01/04→12/07		+ ESP; Schaltgetriebe		24.2120-1756.3 010975	Ø 20,6 ohne Bremsflüssigkeitsbehälter
MAZDA - 6 Kasten/Kombi (GJ) 01/13→05/16							
 Hauptbremszylinder							
2.0	107 - 121	04/15→05/16		für Linkslenker		24.4122-1729.3 011104	Ø 22,2 ohne Bremsflüssigkeitsbehälter
2.2 D	110 - 129	04/15→05/16					
2.2 D AWD	110 - 129	01/13→05/16					
2.5	141	04/15→05/16					
MAZDA - 6 Kombi (GJ, GL) 08/12→							
 Hauptbremszylinder							
2.0	107 - 121	12/12→		für Linkslenker		24.4122-1729.3 011104	Ø 22,2 ohne Bremsflüssigkeitsbehälter
2.2 D	129 - 135	07/14→					
2.2 D AWD	110 - 135	12/12→					
2.5	143	03/18→					
2.2 D	110	10/12→12/20		01/13→; für Linkslenker		24.4122-1729.3 011104	Ø 22,2 ohne Bremsflüssigkeitsbehälter
2.5	141	12/12→					
2.2 D	129	08/12→02/18		12/12→; für Linkslenker		24.4122-1729.3 011104	Ø 22,2 ohne Bremsflüssigkeitsbehälter
2.2 D 4WD	129	07/14→		02/15→; für Linkslenker		24.4122-1729.3 011104	Ø 22,2 ohne Bremsflüssigkeitsbehälter
MAZDA - 6 Station Wagon (GY) 01/02→02/08							
 Hauptbremszylinder							
1.8 2.0	88 104 - 108	08/02→08/07 08/02→08/07		→ 07/07; + ESP; Schaltgetriebe		24.2120-1756.3 010975	Ø 20,6 ohne Bremsflüssigkeitsbehälter
2.0 DI	89 - 105	08/02→08/07					
2.3	122	01/02→02/08					
2.3 AWD	119	11/02→08/07					
2.0 DI	100	08/02→02/05		+ ESP; Schaltgetriebe		24.2120-1756.3 010975	Ø 20,6 ohne Bremsflüssigkeitsbehälter
MAZDA - 6 Stufenheck (GG) 06/02→12/08							
 Hauptbremszylinder							
1.8 2.0	88 104 - 108	08/02→08/07 06/02→08/07		→ 07/07; + ESP; Schaltgetriebe		24.2120-1756.3 010975	Ø 20,6 ohne Bremsflüssigkeitsbehälter
2.0 DI	89 - 105	06/02→08/07					
2.3	122	06/02→08/07					
2.3 MPS Turbo	191	12/05→08/07					
2.3	119 - 120	07/03→07/07		+ ESP; Schaltgetriebe		24.2120-1756.3 010975	Ø 20,6 ohne Bremsflüssigkeitsbehälter
MAZDA - 6 Stufenheck (GJ, GL) 12/12→							
 Hauptbremszylinder							
2.0	107 - 121	12/12→		für Linkslenker		24.4122-1729.3 011104	Ø 22,2 ohne Bremsflüssigkeitsbehälter
2.2 D	129 - 135	12/12→					
2.5	140 - 170	01/13→					
2.2 D	129	07/14→		02/15→; für Linkslenker		24.4122-1729.3 011104	Ø 22,2 ohne Bremsflüssigkeitsbehälter
2.2 D 4WD	129	07/14→					
2.2 D	110	12/12→11/20		01/13→; für Linkslenker		24.4122-1729.3 011104	Ø 22,2 ohne Bremsflüssigkeitsbehälter

	kw					! #		
MAZDA - BT-50 Pick-up (CD, UN) 08/06→12/15								
 Hauptbremszylinder								
2.5 MRZ-CD	105	08/06→06/13			für Linkslenker; + ABS		24.2125-1747.3 011029	Ø 25,4
2.5 MRZ-CD 4x4	105	12/06→12/15			+ ABS; Schaltgetriebe; → 07/12		24.2125-1747.3 011029	Ø 25,4
3.0 CDVi	115	12/06→12/15			+ ABS; Automatikgetriebe; → 07/12		24.2125-1747.3 011029	Ø 25,4
3.0 CDVi 4x4	115	10/06→12/15			12/06→; + ABS; Schaltgetriebe; → 07/12		24.2125-1747.3 011029	Ø 25,4
					12/06→; + ABS; Automatikgetriebe; → 07/12			
MAZDA - BT-50 Pritsche/Fahrgestell (CD, UN) 08/06→								
 Hauptbremszylinder								
2.5 CDVi	105	12/06→			+ ABS; Schaltgetriebe; → 07/12		24.2125-1747.3 011029	Ø 25,4
3.0 CDVi 4x4	115	12/06→			+ ABS; Automatikgetriebe; → 07/12		24.2125-1747.3 011029	Ø 25,4
MAZDA - CX-5 (KE, GH) 11/11→02/17								
 Hauptbremszylinder								
2.0	110 - 121	11/11→02/17			für Linkslenker; Automatikgetriebe		24.2120-1761.3 011090	Ø 20,6 ohne Bremsflüssigkeitsbehälter
2.0 AWD	110 - 118	11/11→02/17						
2.2 D	110 - 129	04/12→02/17						
2.2 D 4WD	129	04/12→02/17						
2.2 D AWD	110 - 129	04/12→02/17						
2.5	137 - 138	02/13→02/17						
2.5 AWD	141	02/15→02/17						
2.0 AWD	113	02/12→02/17			für Linkslenker		24.2120-1761.3 011090	Ø 20,6 ohne Bremsflüssigkeitsbehälter
MAZDA - CX-5 (KF) 11/16→								
 Hauptbremszylinder								
2.0	110 - 121	05/17→			für Linkslenker; Automatikgetriebe		24.2120-1761.3 011090	Ø 20,6 ohne Bremsflüssigkeitsbehälter
2.0 AWD	121	06/18→						
2.0 SKYACTIV-G	120	03/18→						
2.0 SKYACTIV-G AWD	120	03/18→						
2.2 D	110	05/17→02/18						
2.2 D AWD	110	05/17→02/18						
2.0 AWD	110	03/18→			für Linkslenker		24.2120-1761.3 011090	Ø 20,6 ohne Bremsflüssigkeitsbehälter
2.5	141 - 143	05/17→						
2.0 AWD	118	05/17→			Automatikgetriebe		24.2120-1761.3 011090	Ø 20,6 ohne Bremsflüssigkeitsbehälter
2.2 D	129	05/17→						
2.2 D AWD	129	05/17→02/18						
2.0 e-SKYACTIV G 165	121	02/23→			für Linkslenker; Getriebeautomatik 6 Gang		24.2120-1761.3 011090	Ø 20,6 ohne Bremsflüssigkeitsbehälter
2.0 e-SKYACTIV G 165 AWD	121	02/23→						
2.5 e-SKYACTIV G 194	143	02/23→						
2.5 e-SKYACTIV G 194 AWD	143	02/23→						
2.5 AWD	143	05/17→					24.2120-1761.3 011090	Ø 20,6 ohne Bremsflüssigkeitsbehälter
MAZDA - CX-5 Van (KE_) 11/11→02/17								
 Hauptbremszylinder								
SKYACTIV-D	110	04/15→02/17			für Linkslenker; Automatikgetriebe		24.2120-1761.3 011090	Ø 20,6 ohne Bremsflüssigkeitsbehälter
SKYACTIV-D AWD	110 - 129	04/15→02/17						
SKYACTIV-G	121	04/15→02/17						
SKYACTIV-G AWD	118 - 141	04/15→02/17						
MERCEDES-BENZ - A-KLASSE (W168) 07/97→08/05								
 Hauptbremszylinder								
A 140	60	07/97→08/04			09/97→		24.4122-1701.3 010533	TRW Ø 22,2
A 160	75	07/97→08/04						
A 140	60	01/01→08/04					24.4122-1701.3 010533	TRW Ø 22,2
A 160 CDI	55	02/01→08/04						
A 170 CDI	70	02/01→08/04						
A 210	103	12/01→08/04						
A 160 CDI	44	07/98→02/01			08/98→ 01/01		24.4122-1701.3 010533	TRW Ø 22,2
A 170 CDI	66	07/98→02/01			→ 01/01		24.4122-1701.3 010533	TRW Ø 22,2
A 190	92	03/99→08/04			05/99→		24.4122-1701.3 010533	TRW Ø 22,2











	kw			 	! #		
MERCEDES-BENZ - A-KLASSE (W169) 04/04→06/12							
 Hauptbremszylinder							
A 150	70	09/04→06/12		→ 05/12		24.2123-1776.3 010926	TRW Ø 23,8
A 160	70	04/09→06/12					
A 160 CDI	60	09/04→06/12					
A 170	85	09/04→06/12					
A 180	85	04/09→06/12					
A 180 CDI	80	09/04→06/12					
A 200	100	09/04→06/12					
A 200 CDI	100 - 103	09/04→06/12					
A 200 TURBO	142	09/05→06/12					
E-CELL	50	12/10→06/12					
MERCEDES-BENZ - A-KLASSE (W176) 06/12→05/18							
 Hauptbremszylinder							
A 160	75	07/15→05/18		für Linkslenker		24.4123-1718.3 011016	TRW Ø 23,8 ohne Bremsflüssigkeitsbehälter
A 160 CDI / d	66	06/13→05/18					
A 180	90	09/12→05/18					
A 180 CDI / d	80	06/12→05/18					
A 180 CDI	80	06/12→10/14					
A 200	115	06/12→05/18					
A 200 CDI / d	100	02/14→05/18					
A 200 CDI / d 4-matic	100	02/14→05/18					
A 220 4-matic	135	05/14→05/18					
A 220 CDI	120 - 125	09/12→05/18					
A 220 CDI 4-matic	125	02/14→05/18					
A 220 d	130	07/15→05/18					
A 220 d 4-matic	130	07/15→05/18					
A 250	155 - 160	06/12→05/18					
A 250 4-matic	155 - 160	06/13→05/18					
A 45 AMG 4-matic	265	06/13→05/18					
AMG A 45 4-matic	280	07/15→05/18					
A 200 CDI	100	06/12→10/14		für Linkslenker; → 02/14		24.4123-1718.3 011016	TRW Ø 23,8 ohne Bremsflüssigkeitsbehälter
MERCEDES-BENZ - B-KLASSE Sports Tourer (W245) 03/05→11/11							
 Hauptbremszylinder							
B 150	70	03/05→11/11		→ 04/11		24.2123-1776.3 010926	TRW Ø 23,8
B 160	70	04/09→11/11					
B 170	85	03/05→11/11					
B 180	85	04/09→11/11					
B 180 CDI	80	03/05→11/11					
B 200	100	03/05→11/11					
B 200 CDI	100 - 103	03/05→11/11					
B 200 TURBO	142	03/05→11/11					
B 170 NGT	85	04/08→11/11		→ 04/09		24.2123-1776.3 010926	TRW Ø 23,8
B 180 NGT	85	04/08→11/11		04/09→ 04/11		24.2123-1776.3 010926	TRW Ø 23,8
MERCEDES-BENZ - B-KLASSE Sports Tourer (W246, W242) 10/11→12/18							
 Hauptbremszylinder							
B 160	75	07/15→12/18		für Linkslenker		24.4123-1718.3 011016	TRW Ø 23,8 ohne Bremsflüssigkeitsbehälter
B 160 CDI / d	66	05/13→12/18					
B 180	90	11/11→12/18					
B 180 CDI / d	80	02/13→12/18					
B 180 CDI	80	11/11→08/14					
B 200	115	11/11→12/18					
B 200 CDI / d	100	08/14→12/18					
B 200 CDI / d 4-matic	100	08/14→12/18					
B 200 CDI	100	11/11→08/14					
B 200 Natural Gas Drive / B 200 c	115	11/12→12/17					
B 220 4-matic	135	05/13→12/18					
B 220 CDI / d	120 - 130	06/13→12/18					
B 220 CDI / d 4-matic	130	08/14→12/18					
B 220 d 4-matic	125	06/18→12/18					
B 250 4-matic	155	08/14→12/18					
B 220 CDI / d	125	11/11→12/18		12/12→; für Linkslenker		24.4123-1718.3 011016	TRW Ø 23,8 ohne Bremsflüssigkeitsbehälter
B 250	155	05/12→12/18		09/12→; für Linkslenker		24.4123-1718.3 011016	TRW Ø 23,8 ohne Bremsflüssigkeitsbehälter













	kw					! #		
MERCEDES-BENZ - C-KLASSE (W202) 03/93→05/00								
Bremskraftverstärker								
C 180	89 - 90	03/93→05/00		A021677 / F011180→ A519673 / F619720		03.7760-2702.4	300090	ATE Ø 10" pneumatisch
C 200 C 200 Kompressor	100 132 - 141	01/94→05/00 10/95→05/00		→ A519673 / F619720		03.7760-2702.4	300090	ATE Ø 10" pneumatisch
C 230 Kompressor C 250 Turbo-D	142 110	10/95→05/00 10/95→05/00						
C 200 D C 220 D	55 - 65 55 - 70	03/93→05/00 08/93→05/00		A072908 / F060570→ A519673 / F619720		03.7760-2702.4	300090	ATE Ø 10" pneumatisch
C 220	110	03/93→05/00		→ 08/96		03.7760-2702.4	300090	ATE Ø 10" pneumatisch
C 250 D	83	05/93→05/00		→ 08/95; A072908 / F060570→		03.7760-2702.4	300090	ATE Ø 10" pneumatisch
C 280	142	05/93→05/00		06/93→ 05/97		03.7760-2702.4	300090	ATE Ø 10" pneumatisch
C 36 AMG	206	05/94→05/00		→ 08/97		03.7760-2702.4	300090	ATE Ø 10" pneumatisch
Hauptbremszylinder								
C 180	89	11/94→05/00		F011180→		03.2023-0825.3	010028	Ø1 23,8 Ø2 19
				A021677→ A136773		03.2023-0825.3	010028	Ø1 23,8 Ø2 19
				→ A021676 / F011179		24.2022-1601.3	010340	Ø1 22,2 Ø2 17,5
				A136774→		24.2023-1701.3	010514	TRW Ø1 23,8 Ø2 19
C 180	90	03/93→05/00		F011180→		03.2023-0825.3	010028	Ø1 23,8 Ø2 19
				A021677→ A136773		03.2023-0825.3	010028	Ø1 23,8 Ø2 19
				→ A021676 / F011179		24.2022-1601.3	010340	Ø1 22,2 Ø2 17,5
				A136774→ A519673		24.2023-1701.3	010514	TRW Ø1 23,8 Ø2 19
				A519674→		24.2023-1702.3	010534	TRW Ø1 23,8 Ø2 19
C 200	100	01/94→05/00		→ A136773 / F110261		03.2023-0825.3	010028	Ø1 23,8 Ø2 19
				A136774 / F110262→		24.2023-1701.3	010514	TRW Ø1 23,8 Ø2 19
C 200 CDI C 220 CDI	75 92	03/98→05/00 09/97→05/00						
C 200 D	55 - 65	03/93→05/00		A072908 / F060570→		03.2023-0825.3	010028	Ø1 23,8 Ø2 19
				→ A072907 / F060569		24.2022-1601.3	010340	Ø1 22,2 Ø2 17,5
C 200 Kompressor C 230 Kompressor C 250 Turbo-D	132 - 141 142 110	10/95→05/00 10/95→05/00 10/95→05/00		→ A519673 / F619720		24.2023-1701.3	010514	TRW Ø1 23,8 Ø2 19
				A519674 / F619721→		24.2023-1702.3	010534	TRW Ø1 23,8 Ø2 19
C 220	110	03/93→05/00		06/93→; → A136773 / F110261		03.2023-0825.3	010028	Ø1 23,8 Ø2 19
				→ 08/96; A136774 / F110262→		24.2023-1701.3	010514	TRW Ø1 23,8 Ø2 19
C 220 D	55 - 70	08/93→05/00		A072908 / F060570→ A136773 / F110261		03.2023-0825.3	010028	Ø1 23,8 Ø2 19
				→ A072907 / F060569		24.2022-1601.3	010340	Ø1 22,2 Ø2 17,5
				A136774 / F110262→ A519673 / F619720		24.2023-1701.3	010514	TRW Ø1 23,8 Ø2 19
				A519674 / F619721→		24.2023-1702.3	010534	TRW Ø1 23,8 Ø2 19
C 240	125	06/97→05/00		- ESP		24.2023-1702.3	010534	TRW Ø1 23,8 Ø2 19
				+ ESP		24.2023-1704.3	010635	TRW Ø 23,8
C 250 D	83	05/93→05/00		A072908 / F060570→; → 08/95		03.2023-0825.3	010028	Ø1 23,8 Ø2 19
				06/93→; → A072907 / F060569		24.2022-1601.3	010340	Ø1 22,2 Ø2 17,5
C 280	142	05/93→05/00		06/93→; → A136773 / F110261		03.2023-0825.3	010028	Ø1 23,8 Ø2 19
				→ 05/97; A136774 / F110262→		24.2023-1701.3	010514	TRW Ø1 23,8 Ø2 19
				06/97→; - ESP		24.2023-1702.3	010534	TRW Ø1 23,8 Ø2 19
				06/97→; + ESP		24.2023-1704.3	010635	TRW Ø 23,8
C 280	145	06/97→05/00		→ A136773 / F110261		03.2023-0825.3	010028	Ø1 23,8 Ø2 19
				- ESP		24.2023-1702.3	010534	TRW Ø1 23,8 Ø2 19
				+ ESP		24.2023-1704.3	010635	TRW Ø 23,8
C 36 AMG	206	05/94→05/00		→ A136773 / F110261		03.2023-0825.3	010028	Ø1 23,8 Ø2 19
				→ 08/97; A136774 / F110262→		24.2023-1701.3	010514	TRW Ø1 23,8 Ø2 19
C 43 AMG	225	08/97→05/00		für Linkslenker; → F737081		24.2025-1703.3	010516	Ø1 25,4 Ø2 19
				für Rechtslenker		24.2025-1709.3	010693	Ø 25,4
				für Linkslenker; F737082→		24.2025-1709.3	010693	Ø 25,4
MERCEDES-BENZ - C-KLASSE (W203) 05/00→12/07								
Bremskraftverstärker								
C 180 C 180 Kompressor →	95 105	10/00→05/02 05/02→02/07		für Linkslenker		03.7848-2002.4	300166	ATE Ø 7 / 8" pneumatisch











	kw			 	! #		
MERCEDES-BENZ - C-KLASSE (W203) 05/00→12/07							
Bremskraftverstärker							
C 200 CDI	75 - 90	09/00→02/07		für Linkslenker		03.7848-2002.4 300166	ATE Ø 7 / 8" pneumatisch
C 200 CGI Kompressor	125	07/03→02/07					
C 200 Kompressor	120	05/02→02/07					
C 220 CDI	100 - 105	05/00→02/07					
C 230 Kompressor	141	02/04→02/07					
C 240	125	05/00→02/07					
C 240 4-matic	125	07/02→02/07					
C 270 CDI	120 - 125	12/00→02/07					
C 30 CDI AMG	170	01/03→02/07					
C 320	160	05/00→02/07					
C 320 4-matic	160	07/02→02/07					
C 55 AMG	270	02/04→02/07					
C 200 Kompressor	120	05/00→06/02		→ 05/02; für Linkslenker		03.7848-2002.4 300166	ATE Ø 7 / 8" pneumatisch
C 220 CDI	110	04/03→02/07		02/04→; für Linkslenker		03.7848-2002.4 300166	ATE Ø 7 / 8" pneumatisch
C 230	150	01/05→02/07		06/05→; für Linkslenker		03.7848-2002.4 300166	ATE Ø 7 / 8" pneumatisch
C 280	170	01/05→02/07					
C 280 4-matic	170	01/05→02/07					
C 350	200	01/05→02/07					
C 350 4-matic	200	01/05→02/07					
C 320 CDI	165	01/05→02/07		02/05→; für Linkslenker		03.7848-2002.4 300166	ATE Ø 7 / 8" pneumatisch
C 32 AMG Kompressor	260	02/01→02/07		03/01→; für Linkslenker		03.7848-2002.4 300166	ATE Ø 7 / 8" pneumatisch
Pedalwegsensoren, Bremspedal							
C 180	95	10/00→05/02				03.0655-0007.2 370007	ATE
C 180 Kompressor	105	05/02→02/07					
C 200 CDI	75 - 90	09/00→02/07					
C 200 CGI Kompressor	125	07/03→02/07					
C 200 Kompressor	120	05/02→02/07					
C 220 CDI	100 - 105	05/00→02/07					
C 230 Kompressor	141	02/04→02/07					
C 240	125	05/00→02/07					
C 240 4-matic	125	07/02→02/07					
C 270 CDI	120 - 125	12/00→02/07					
C 30 CDI AMG	170	01/03→02/07					
C 320	160	05/00→02/07					
C 320 4-matic	160	07/02→02/07					
C 55 AMG	270	02/04→02/07					
C 200 Kompressor	120	05/00→06/02		→ 05/02		03.0655-0007.2 370007	ATE
C 220 CDI	110	04/03→02/07		02/04→		03.0655-0007.2 370007	ATE
C 230	150	01/05→02/07		06/05→		03.0655-0007.2 370007	ATE
C 280	170	01/05→02/07					
C 350	200	01/05→02/07					
C 350 4-matic	200	01/05→02/07					
C 280 4-matic	170	01/05→02/07		06/05→; für Linkslenker		03.0655-0007.2 370007	ATE
C 320 CDI	165	01/05→02/07		02/05→		03.0655-0007.2 370007	ATE
C 32 AMG Kompressor	260	02/01→02/07		03/01→		03.0655-0007.2 370007	ATE
Hauptbremszylinder							
C 180	95	10/00→05/02		für Linkslenker		03.2023-1741.3 010703	ATE Ø1 23,8 Ø2 20,6
C 180 Kompressor	105	05/02→02/07					
C 200 CDI	75 - 90	09/00→02/07					
C 200 CGI Kompressor	125	07/03→02/07					
C 200 Kompressor	120	05/02→02/07					
C 220 CDI	100 - 105	05/00→02/07					
C 230 Kompressor	141	02/04→02/07					
C 240	125	05/00→02/07					
C 200 Kompressor	120	05/00→06/02		→ 05/02; für Linkslenker		03.2023-1741.3 010703	ATE Ø1 23,8 Ø2 20,6
C 220 CDI	110	04/03→02/07		02/04→; für Linkslenker		03.2023-1741.3 010703	ATE Ø1 23,8 Ø2 20,6
C 230	150	01/05→02/07		06/05→; für Linkslenker		03.2025-1741.3 010705	ATE Ø1 25,4 Ø2 20,6
C 280	170	01/05→02/07					
C 280 4-matic	170	01/05→02/07					
C 350	200	01/05→02/07					
C 350 4-matic	200	01/05→02/07					
C 240 4-matic	125	07/02→02/07		für Linkslenker		03.2025-1741.3 010705	ATE Ø1 25,4 Ø2 20,6
C 270 CDI	120 - 125	12/00→02/07					
C 30 CDI AMG	170	01/03→02/07					
C 320	160	05/00→02/07					
C 320 4-matic	160	07/02→02/07					
C 55 AMG	270	02/04→02/07					
→							











	kW					! #		
MERCEDES-BENZ - C-KLASSE (W203) 05/00→12/07								
 Hauptbremszylinder								
C 320 CDI	165	01/05→02/07		02/05→;	für Linkslenker		03.2025-1741.3 010705	ATE Ø1 25,4 Ø2 20,6
C 32 AMG Kompressor	260	02/01→02/07		03/01→;	für Linkslenker		03.2025-1741.3 010705	ATE Ø1 25,4 Ø2 20,6
MERCEDES-BENZ - C-KLASSE (W204) 01/07→01/15								
 Bremskraftverstärker								
C 180 CDI	88	04/10→03/14			für Linkslenker; für Fahrzeuge ohne Start-Stopp-Funktion		03.7745-6302.4 300261	ATE Ø 8" pneumatisch
C 180 Kompressor	115	01/08→01/14						
C 200	137	05/11→01/14						
C 200 CDI	100	11/09→03/14			für Linkslenker; für Fahrzeuge mit Start-Stopp-Funktion		03.7745-8902.4 300297	ATE Ø 8" pneumatisch
C 220 CDI	120 - 125	10/08→01/14						
C 220 CDI 4-matic	125	02/13→01/14						
C 230 4-matic	150	07/07→01/14						
C 250 CDI	150	08/08→01/14						
C 250 CDI 4-matic	150	01/11→01/14						
C 250 CGI	150	07/09→01/14						
C 280 4-matic	170	07/07→01/14						
C 300	185	02/11→01/14						
C 300 4-matic	185	02/11→01/14						
C 300 CDI 4-matic	170	01/11→01/14						
C 320 CDI 4-matic	165	07/07→01/14						
C 350	225	01/11→01/14						
C 350 4-matic	200 - 225	07/07→01/14						
C 350 CDI	170 - 195	10/09→01/14						
C 350 CDI 4-matic	165 - 170	07/09→01/14						
C 350 CGI	215	09/08→01/14						
C 180 CGI	115	01/07→01/14		04/09→;	für Linkslenker; für Fahrzeuge ohne Start-Stopp-Funktion		03.7745-6302.4 300261	ATE Ø 8" pneumatisch
C 200 CGI	135	01/07→01/14						
C 300 4-matic	170	07/07→01/14		04/09→;	für Linkslenker; für Fahrzeuge mit Start-Stopp-Funktion		03.7745-8902.4 300297	ATE Ø 8" pneumatisch
C 180 Kompressor	115	01/07→01/14		03/07→;	für Linkslenker; für Fahrzeuge ohne Start-Stopp-Funktion		03.7745-6302.4 300261	ATE Ø 8" pneumatisch
C 200 CDI	100	01/07→12/09						
C 220 CDI	120	01/07→11/08						
C 230	150	01/07→01/14		03/07→;	für Linkslenker; für Fahrzeuge mit Start-Stopp-Funktion		03.7745-8902.4 300297	ATE Ø 8" pneumatisch
C 200 Kompressor	135	01/07→01/14			A 017628 / F 015295→; für Linkslenker; für Fahrzeuge ohne Start-Stopp-Funktion		03.7745-6302.4 300261	ATE Ø 8" pneumatisch
C 220 CDI	125	01/07→11/08						
C 280	170	01/07→01/14						
C 300	170	07/09→01/14			A 017628 / F 015295→; für Linkslenker; für Fahrzeuge mit Start-Stopp-Funktion		03.7745-8902.4 300297	ATE Ø 8" pneumatisch
C 320 CDI	165	01/07→01/14						
C 350	200	01/07→01/14						
C 350 CDI	165	07/09→01/14						
C 63 AMG	336 - 373	02/08→01/14						
C 63 AMG DR 520	383	07/10→01/14						
 Hauptbremszylinder								
C 180 CDI	88	04/10→03/14			für Linkslenker		03.2025-2521.3 010959	ATE Ø1 25,4 Ø2 20,6
C 180 Kompressor	115	01/08→01/14						
C 200	137	05/11→01/14			für Rechtslenker		24.2025-2311.3 011023	ATE Ø1 25,4 Ø2 20,6
C 200 CDI	100	11/09→03/14						
C 220 CDI	120 - 125	10/08→01/14						
C 220 CDI 4-matic	125	02/13→01/14						
C 230 4-matic	150	07/07→01/14						
C 250 CDI 4-matic	150	01/11→01/14						
C 250 CGI	150	07/09→01/14						
C 280 4-matic	170	07/07→01/14						
C 300	170 - 185	07/09→01/14						
C 300 4-matic	185	02/11→01/14						
C 300 CDI 4-matic	170	01/11→01/14						
C 320 CDI 4-matic	165	07/07→01/14						
C 350	225	01/11→01/14						
C 350 4-matic	200 - 225	07/07→01/14						
C 350 CDI	165 - 195	07/09→01/14						
C 350 CDI 4-matic	165 - 170	07/09→01/14						
C 350 CGI	215	09/08→01/14						
C 63 AMG	336 - 373	02/08→01/14						
C 63 AMG DR 520	383	07/10→01/14						
C 180 CGI	115	01/07→01/14		04/09→;	für Linkslenker		03.2025-2521.3 010959	ATE Ø1 25,4 Ø2 20,6
C 200 CGI	135	01/07→01/14						
C 300 4-matic	170	07/07→01/14		04/09→;	für Rechtslenker		24.2025-2311.3 011023	ATE Ø1 25,4 Ø2 20,6
C 180 Kompressor	115	01/07→01/14		03/07→;	für Linkslenker		03.2025-2521.3 010959	ATE Ø1 25,4 Ø2 20,6



















	kw			 	! #		
MERCEDES-BENZ - C-KLASSE (W204) 01/07→01/15							
 Hauptbremszylinder							
C 200 CDI C 200 Kompressor C 220 CDI	100 135 120 -	01/07→12/09 01/07→01/14 01/07→11/08		03/07→; für Rechtslenker		24.2025-2311.3 011023	ATE Ø1 25,4 Ø2 20,6
C 230 C 280 C 320 CDI C 350	125 150 170 165 200	01/07→01/14 01/07→01/14 01/07→01/14 01/07→01/14					
C 250 CDI	150	08/08→01/14		10/08→; für Linkslenker		03.2025-2521.3 010959	ATE Ø1 25,4 Ø2 20,6
				10/08→; für Rechtslenker		24.2025-2311.3 011023	ATE Ø1 25,4 Ø2 20,6
MERCEDES-BENZ - C-KLASSE (W205) 07/13→02/23							
 Bremskraftverstärker							
AMG C 43 4-matic	287	05/18→05/21		Sonderausstattungscode (SA-Code) ab: 809 →		03.7845-2506.4 300329	ATE Ø 8" pneumatisch
C 160 C 180 C 180 d C 200 C 200 4-matic C 200 d	95 115 90 150 150 110 -	06/19→05/21 06/19→05/21 05/18→05/21 08/19→05/21 08/19→05/21 05/18→05/21				03.7845-2506.4 300329	ATE Ø 8" pneumatisch
C 200 EQ Boost C 200 EQ Boost 4-matic C 220 d C 220 d 4-matic C 300	135 135 143 143 183 -	04/18→06/21 04/18→05/21 05/18→05/21 05/18→05/21 05/18→05/21					
C 300 4-matic	180 -	12/13→05/21					
C 300 d C 300 d 4-matic C 300 de C 300 e C 300 e 4-matic C 300 EQ Boost C 300 EQ Boost 4-matic	118 190 180 180 225 235 235 190 190	06/18→05/21 06/18→05/21 05/19→05/21 07/19→05/21 07/19→05/21 05/19→05/21 05/19→05/21					
 Hauptbremszylinder							
AMG C 43 4-matic AMG C 63 AMG C 63 S C 160 C 180	270 350 375 95 110 -	04/16→05/18 10/14→05/21 10/14→05/21 04/15→11/19 03/14→03/21		für Linkslenker		24.4156-1136.3 011126	ATE Ø 27 ohne Bremsflüssigkeitsbehälter
C 180 BlueTEC / d C 200 4-matic C 200 BlueTEC / d C 200 d C 220 BlueTEC / d	115 85 135 100 100 120 -	05/14→05/18 04/15→08/18 05/14→05/18 10/15→05/18 02/14→05/18					
C 220 d 4-matic C 250 C 250 BlueTEC / d C 250 BlueTEC / d 4-matic C 300 C 300 BlueTEC Hybrid / h C 350 e C 400 4-matic C 450 AMG 4-matic	125 155 150 150 180 170 205 245 270	04/15→05/18 03/14→05/18 02/14→05/18 02/14→05/18 09/15→08/18 05/14→05/18 02/15→08/18 10/14→11/20 04/15→05/18					
AMG C 43 4-matic	287	05/18→05/21		für Linkslenker; +SA 805/806 / 807/808		24.4156-1136.3 011126	ATE Ø 27 ohne Bremsflüssigkeitsbehälter
				für Linkslenker; Sonderausstattungscode (SA-Code) ab: 809 →		24.4156-1221.3 011127	ATE Ø 27 ohne Bremsflüssigkeitsbehälter
C 160 C 180 C 180 d C 200 C 200 d	95 115 90 150 110 -	06/19→05/21 06/19→05/21 05/18→05/21 08/19→05/21 05/18→05/21		für Linkslenker		24.4156-1221.3 011127	ATE Ø 27 ohne Bremsflüssigkeitsbehälter
C 200 EQ Boost C 200 EQ Boost 4-matic C 220 d C 220 d 4-matic C 300	118 135 135 143 143 183 -	04/18→06/21 04/18→05/21 05/18→05/21 05/18→05/21 05/18→05/21					
C 300 4-matic C 300 d	190 180	05/18→05/21 06/18→05/21					
→							

	kw					! #		
MERCEDES-BENZ - C-KLASSE (W205) 07/13→02/23								
 Hauptbremszylinder								
C 300 d 4-matic C 300 de C 300 e C 300 e 4-matic C 300 EQ Boost C 300 EQ Boost 4-matic	180 225 235 235 190 190	06/18→05/21 05/19→05/21 07/19→05/21 07/19→05/21 05/19→05/21 05/19→05/21		für Linkslenker			24.4156-1221.3 011127	ATE Ø 27 ohne Bremsflüssigkeitsbehälter
C 200	135	12/13→08/18		02/14→; für Linkslenker			24.4156-1136.3 011126	ATE Ø 27 ohne Bremsflüssigkeitsbehälter
C 200 4-matic C 300 4-matic	150 180	08/19→05/21 12/13→08/18		für Linkslenker; +SA 805/806 / 807/808			24.4156-1136.3 011126	ATE Ø 27 ohne Bremsflüssigkeitsbehälter
				für Linkslenker			24.4156-1221.3 011127	ATE Ø 27 ohne Bremsflüssigkeitsbehälter
MERCEDES-BENZ - C-KLASSE Cabriolet (A205) 06/16→04/23								
 Bremskraftverstärker								
AMG C 43 4-matic AMG C 63 AMG C 63 S	270 - 287 350 375	10/16→04/23 10/16→04/23 10/16→04/23		Sonderausstattungscode (SA-Code) ab: 809 →			03.7845-2506.4 300329	ATE Ø 8" pneumatisch
C 180 C 200 C 200 d C 200 EQ Boost C 200 EQ Boost 4-matic C 220 d C 220 d 4-matic C 300 C 300 d C 300 EQ Boost C 300 EQ Boost 4-matic	115 150 118 135 135 143 143 190 180 190 190	06/19→04/23 08/19→04/23 07/18→11/19 05/18→04/23 05/18→04/23 04/18→04/23 06/18→04/23 05/18→04/23 07/18→04/23 05/19→04/23 05/19→04/23					03.7845-2506.4 300329	ATE Ø 8" pneumatisch
 Hauptbremszylinder								
AMG C 43 4-matic AMG C 63 AMG C 63 S	270 - 287 350 375	10/16→04/23 10/16→04/23 10/16→04/23		für Linkslenker; +SA 805/806 / 807/808			24.4156-1136.3 011126	ATE Ø 27 ohne Bremsflüssigkeitsbehälter
				für Linkslenker; Sonderausstattungscode (SA-Code) ab: 809 →			24.4156-1221.3 011127	ATE Ø 27 ohne Bremsflüssigkeitsbehälter
C 180 C 200 C 200 4-matic C 220 d C 220 d 4-matic C 250 C 250 d C 300 C 400 4-matic	115 135 135 120 - 125 125 155 150 180 245	06/16→08/20 06/16→05/18 06/16→05/18 06/16→05/18 06/16→05/18 06/16→05/18 06/16→05/18 06/16→05/18 06/16→04/23		für Linkslenker			24.4156-1136.3 011126	ATE Ø 27 ohne Bremsflüssigkeitsbehälter
C 180 C 200 C 200 d C 200 EQ Boost C 200 EQ Boost 4-matic C 220 d C 220 d 4-matic C 300 C 300 d C 300 EQ Boost C 300 EQ Boost 4-matic	115 150 118 135 135 143 143 190 180 190 190	06/19→04/23 08/19→04/23 07/18→11/19 05/18→04/23 05/18→04/23 04/18→04/23 06/18→04/23 05/18→04/23 07/18→04/23 05/19→04/23 05/19→04/23		für Linkslenker			24.4156-1221.3 011127	ATE Ø 27 ohne Bremsflüssigkeitsbehälter
MERCEDES-BENZ - C-KLASSE Coupe (C204) 01/11→								
 Bremskraftverstärker								
C 180 C 200 CGI C 220 CDI	115 135 120 - 125	06/11→ 06/11→ 06/11→		für Linkslenker; für Fahrzeuge ohne Start-Stopp-Funktion			03.7745-6302.4 300261	ATE Ø 8" pneumatisch
C 250 C 250 CDI C 350 C 350 4-matic C 63 AMG	150 150 225 225 336 - 380	06/11→ 06/11→ 06/11→ 09/13→ 06/11→		für Linkslenker; für Fahrzeuge mit Start-Stopp-Funktion			03.7745-8902.4 300297	ATE Ø 8" pneumatisch
 Hauptbremszylinder								
C 180 C 200 CGI C 220 CDI	115 135 120 - 125	06/11→ 06/11→ 06/11→		für Linkslenker			03.2025-2521.3 010959	ATE Ø1 25,4 Ø2 20,6
C 250 C 250 CDI	150 150	06/11→ 06/11→		für Rechtslenker			24.2025-2311.3 011023	ATE Ø1 25,4 Ø2 20,6

	kw					! #		
MERCEDES-BENZ - C-KLASSE Coupe (C204) 01/11→								
 Hauptbremszylinder								
C 350	225	06/11→		für Linkslenker		03.2025-2521.3	010959	ATE Ø1 25,4 Ø2 20,6
C 350 4-matic	225	09/13→		für Rechtslenker		24.2025-2311.3	011023	ATE Ø1 25,4 Ø2 20,6
C 63 AMG	336 - 380	06/11→						
MERCEDES-BENZ - C-KLASSE Coupe (C205) 10/15→04/23								
 Bremskraftverstärker								
AMG C 43 4-matic	287	05/18→04/23		Sonderausstattungscode (SA-Code) ab: 809 →		03.7845-2506.4	300329	ATE Ø 8" pneumatisch
C 180	115	06/19→04/23				03.7845-2506.4	300329	ATE Ø 8" pneumatisch
C 200 d	118	07/18→11/19						
C 200 EQ Boost	135	05/18→04/23						
C 200 EQ Boost 4-matic	135	05/18→04/23						
C 220 d	143	04/18→04/23						
C 220 d 4-matic	143	06/18→04/23						
C 300	190	05/18→04/23						
C 300 4-matic	190	05/18→04/23						
C 300 d	180	07/18→04/23						
C 300 d 4-matic	180	07/18→04/23						
C 300 EQ Boost	190	05/19→04/23						
C 300 EQ Boost 4-matic	190	05/19→04/23						
 Hauptbremszylinder								
AMG C 43 4-matic	270	04/16→05/18				24.4156-1136.3	011126	ATE Ø 27 ohne Bremsflüssigkeitsbehälter
AMG C 63	350	02/16→04/23						
AMG C 63 S	375	02/16→04/23						
C 180	110 - 115	10/15→08/20						
C 200	135	10/15→05/18						
C 200 4-matic	135	04/16→05/18						
C 220 d	120 - 125	10/15→05/18						
C 220 d 4-matic	125	04/16→05/18						
C 250	155	10/15→05/18						
C 250 d	150	10/15→05/18						
C 250 d 4-matic	150	04/16→05/18						
C 300	180	10/15→12/18						
C 400 4-matic	245	04/16→06/22						
AMG C 43 4-matic	287	05/18→04/23		für Linkslenker; +SA 805/806 / 807/808		24.4156-1136.3	011126	ATE Ø 27 ohne Bremsflüssigkeitsbehälter
				für Linkslenker; Sonderausstattungscode (SA-Code) ab: 809 →		24.4156-1221.3	011127	ATE Ø 27 ohne Bremsflüssigkeitsbehälter
C 180	115	06/19→04/23		für Linkslenker		24.4156-1221.3	011127	ATE Ø 27 ohne Bremsflüssigkeitsbehälter
C 200 d	118	07/18→11/19						
C 200 EQ Boost	135	05/18→04/23						
C 200 EQ Boost 4-matic	135	05/18→04/23						
C 220 d	143	04/18→04/23						
C 220 d 4-matic	143	06/18→04/23						
C 300	190	05/18→04/23						
C 300 4-matic	190	05/18→04/23						
C 300 d	180	07/18→04/23						
C 300 d 4-matic	180	07/18→04/23						
C 300 EQ Boost	190	05/19→04/23						
C 300 EQ Boost 4-matic	190	05/19→04/23						
MERCEDES-BENZ - C-KLASSE Sportcoupe (CL203) 03/01→06/11								
 Bremskraftverstärker								
C 160 Kompressor	90	05/02→05/08		04/05→; für Linkslenker		03.7848-2002.4	300166	ATE Ø 7 / 8" pneumatisch
C 180	95	03/01→05/02		für Linkslenker		03.7848-2002.4	300166	ATE Ø 7 / 8" pneumatisch
C 180 Kompressor	105	05/02→05/08						
C 200 Kompressor	120	03/01→05/08						
C 220	120	05/02→05/08						
C 220 CDI	100 - 110	03/01→05/08						
C 230 Kompressor	141 - 145	03/01→05/08						
C 30 CDI AMG	170	09/02→05/08						
C 320	160	09/02→05/08						
C 200 CDI	90	03/03→05/08		07/03→; für Linkslenker		03.7848-2002.4	300166	ATE Ø 7 / 8" pneumatisch
C 200 CGI Kompressor	125	03/03→05/08						
C 230	150	01/05→05/08		06/05→; für Linkslenker		03.7848-2002.4	300166	ATE Ø 7 / 8" pneumatisch
C 350	200	01/05→05/08						
Pedalwegsensor, Bremspedal								
C 160 Kompressor	90	05/02→05/08		04/05→		03.0655-0007.2	370007	ATE
C 180	95	03/01→05/02				03.0655-0007.2	370007	ATE
C 180 Kompressor	105	05/02→05/08						
C 200 Kompressor	120	03/01→05/08						

	kW					! #		
MERCEDES-BENZ - C-KLASSE Sportcoupe (CL203) 03/01→06/11								
Pedalwegsensor, Bremspedal								
C 220	120	05/02→05/08					03.0655-0007.2 370007	ATE
C 220 CDI	100 - 110	03/01→05/08						
C 230 Kompressor	141 - 145	03/01→05/08						
C 30 CDI AMG	170	09/02→05/08						
C 320	160	09/02→05/08						
C 200 CDI	90	03/03→05/08		07/03→			03.0655-0007.2 370007	ATE
C 200 CGI Kompressor	125	03/03→05/08						
C 230	150	01/05→05/08		06/05→			03.0655-0007.2 370007	ATE
C 350	200	01/05→05/08						
 Hauptbremszylinder								
C 160 Kompressor	90	05/02→05/08		04/05→; für Linkslenker			03.2023-1741.3 010703	ATE Ø1 23,8 Ø2 20,6
C 180	95	03/01→05/02		für Linkslenker			03.2023-1741.3 010703	ATE Ø1 23,8 Ø2 20,6
C 180 Kompressor	105	05/02→05/08						
C 200 Kompressor	120	03/01→05/08						
C 220	120	05/02→05/08						
C 220 CDI	100 - 110	03/01→05/08						
C 230 Kompressor	141 - 145	03/01→05/08						
C 200 CDI	90	03/03→05/08		07/03→; für Linkslenker			03.2023-1741.3 010703	ATE Ø1 23,8 Ø2 20,6
C 200 CGI Kompressor	125	03/03→05/08						
C 230	150	01/05→05/08		06/05→; für Linkslenker			03.2025-1741.3 010705	ATE Ø1 25,4 Ø2 20,6
C 350	200	01/05→05/08						
C 30 CDI AMG	170	09/02→05/08		für Linkslenker			03.2025-1741.3 010705	ATE Ø1 25,4 Ø2 20,6
C 320	160	09/02→05/08						
MERCEDES-BENZ - C-KLASSE T-Model (S202) 06/96→03/01								
 Bremskraftverstärker								
C 180 T	90 - 95	06/96→03/01		→ F619720			03.7760-2702.4 300090	ATE Ø 10" pneumatisch
C 200 T	100	06/96→03/01						
C 200 T D	65	10/96→03/01						
C 200 T Kompressor	120 - 141	11/96→03/01						
C 220 T D	55	06/96→03/01						
C 250 T Turbo-D	110	06/96→03/01						
 Hauptbremszylinder								
C 180 T	90 - 95	06/96→03/01		→ F619720			24.2023-1701.3 010514	TRW Ø1 23,8 Ø2 19
C 200 T	100	06/96→03/01		F619721→			24.2023-1702.3 010534	TRW Ø1 23,8 Ø2 19
C 200 T D	65	10/96→03/01						
C 200 T Kompressor	141	11/96→03/01						
C 220 T D	55	06/96→03/01						
C 250 T Turbo-D	110	06/96→03/01						
C 200 T CDI	75	03/98→03/01					24.2023-1702.3 010534	TRW Ø1 23,8 Ø2 19
C 220 T CDI	92	09/97→03/01						
C 230 T Kompressor	142	06/97→09/00						
C 200 T Kompressor	120	09/00→03/01		→ F619720			24.2023-1701.3 010514	TRW Ø1 23,8 Ø2 19
				F619621→			24.2023-1702.3 010534	TRW Ø1 23,8 Ø2 19
C 240 T	125	06/97→03/01		- ESP			24.2023-1702.3 010534	TRW Ø1 23,8 Ø2 19
C 280 T	145	06/97→03/01		+ ESP			24.2023-1704.3 010635	TRW Ø 23,8
C 43 AMG	225	08/97→03/01		für Linkslenker; → F737081			24.2025-1703.3 010516	Ø1 25,4 Ø2 19
				für Rechtslenker			24.2025-1709.3 010693	Ø 25,4
				für Linkslenker; F737082→			24.2025-1709.3 010693	Ø 25,4
MERCEDES-BENZ - C-KLASSE T-Model (S203) 03/01→08/07								
 Bremskraftverstärker								
C 180	95	03/01→05/02		für Linkslenker			03.7848-2002.4 300166	ATE Ø 7 / 8" pneumatisch
C 180 Kompressor	105	05/02→08/07						
C 200 CDI	75 - 90	03/01→08/07						
C 200 CGI Kompressor	125	07/03→08/07						
C 200 Kompressor	120	05/02→08/07						
C 220 CDI	100 - 110	03/01→08/07						
C 230 Kompressor	141	02/04→08/07						
C 240	125	03/01→08/07						
C 240 4-matic	125	07/02→08/07						
C 270 CDI	120 - 125	03/01→08/07						
C 30 CDI AMG	170	01/03→08/07						
C 320	160	03/01→08/07						
→								

	kw					! #		
MERCEDES-BENZ - C-KLASSE T-Model (S203) 03/01→08/07								
 Bremskraftverstärker								
C 320 4-matic	160	07/02→08/07		für Linkslenker		03.7848-2002.4	300166	ATE Ø 7 / 8" pneumatisch
C 320 CDI	165	06/05→08/07						
C 32 AMG Kompressor	260	03/01→08/07						
C 55 AMG	270	02/04→08/07						
C 200 Kompressor	120	03/01→05/02		→ 04/02; für Linkslenker		03.7848-2002.4	300166	ATE Ø 7 / 8" pneumatisch
C 230	150	01/05→08/07		06/05→; für Linkslenker		03.7848-2002.4	300166	ATE Ø 7 / 8" pneumatisch
C 280	170	01/05→08/07						
C 280 4-matic	170	01/05→08/07						
C 350	200	01/05→08/07						
C 350 4-matic	200	01/05→08/07						
Pedalwegsensord, Bremspedal								
C 180	95	03/01→05/02				03.0655-0007.2	370007	ATE
C 180 Kompressor	105	05/02→08/07						
C 200 CDI	75 -	03/01→08/07						
	90							
C 200 CGI Kompressor	125	07/03→08/07						
C 200 Kompressor	120	05/02→08/07						
C 220 CDI	100 -	03/01→08/07						
	110							
C 230 Kompressor	141	02/04→08/07						
C 240	125	03/01→08/07						
C 240 4-matic	125	07/02→08/07						
C 270 CDI	120 -	03/01→08/07						
	125							
C 30 CDI AMG	170	01/03→08/07						
C 320	160	03/01→08/07						
C 320 4-matic	160	07/02→08/07						
C 320 CDI	165	06/05→08/07						
C 32 AMG Kompressor	260	03/01→08/07						
C 55 AMG	270	02/04→08/07						
C 200 Kompressor	120	03/01→05/02		→ 04/02		03.0655-0007.2	370007	ATE
C 230	150	01/05→08/07		06/05→		03.0655-0007.2	370007	ATE
C 280	170	01/05→08/07						
C 350	200	01/05→08/07						
C 350 4-matic	200	01/05→08/07						
C 280 4-matic	170	01/05→08/07		06/05→; für Linkslenker		03.0655-0007.2	370007	ATE
 Hauptbremszylinder								
C 180	95	03/01→05/02		für Linkslenker		03.2023-1741.3	010703	ATE Ø1 23,8 Ø2 20,6
C 180 Kompressor	105	05/02→08/07						
C 200 CDI	75 -	03/01→08/07						
	90							
C 200 CGI Kompressor	125	07/03→08/07						
C 200 Kompressor	120	05/02→08/07						
C 220 CDI	100 -	03/01→08/07						
	110							
C 230 Kompressor	141	02/04→08/07						
C 240	125	03/01→08/07						
C 200 Kompressor	120	03/01→05/02		→ 04/02; für Linkslenker		03.2023-1741.3	010703	ATE Ø1 23,8 Ø2 20,6
C 230	150	01/05→08/07		06/05→; für Linkslenker		03.2025-1741.3	010705	ATE Ø1 25,4 Ø2 20,6
C 280	170	01/05→08/07						
C 280 4-matic	170	01/05→08/07						
C 350	200	01/05→08/07						
C 350 4-matic	200	01/05→08/07						
C 240 4-matic	125	07/02→08/07		für Linkslenker		03.2025-1741.3	010705	ATE Ø1 25,4 Ø2 20,6
C 270 CDI	120 -	03/01→08/07						
	125							
C 30 CDI AMG	170	01/03→08/07						
C 320	160	03/01→08/07						
C 320 4-matic	160	07/02→08/07						
C 320 CDI	165	06/05→08/07						
C 32 AMG Kompressor	260	03/01→08/07						
C 55 AMG	270	02/04→08/07						
MERCEDES-BENZ - C-KLASSE T-Model (S204) 08/07→08/14								
 Bremskraftverstärker								
C 180	115	02/12→08/14		für Linkslenker; für Fahrzeuge ohne Start-Stopp-Funktion		03.7745-6302.4	300261	ATE Ø 8" pneumatisch
C 180 CDI	88	04/10→08/14						
C 180 CGI	115	11/09→08/14						
C 180 Kompressor	115	01/08→08/14		für Linkslenker; für Fahrzeuge mit Start-Stopp-Funktion		03.7745-8902.4	300297	ATE Ø 8" pneumatisch
C 200 CDI	100	08/10→08/14						
C 220 CDI	120 -	12/08→08/14						
	125							
C 220 CDI 4-matic	125	02/13→08/14						
C 250	150	02/08→12/12						
C 250 CDI 4-matic	150	04/10→08/14						
C 250 CGI	150	07/09→08/14						
C 300	170	08/07→08/14						
→								

	kw					! #		
MERCEDES-BENZ - C-KLASSE T-Model (S204) 08/07→08/14								
Bremskraftverstärker								
C 300 CDI 4-matic C 350 CDI	170 165 - 195	06/11→08/14 08/07→08/14		für Linkslenker; für Fahrzeuge ohne Start-Stopp-Funktion		03.7745-6302.4	300261	ATE Ø 8" pneumatisch
C 350 CDI 4-matic C 350 CGI C 63 AMG	170 225 - 336 - 383	10/09→08/14 06/11→08/14 02/08→08/14		für Linkslenker; für Fahrzeuge mit Start-Stopp-Funktion		03.7745-8902.4	300297	ATE Ø 8" pneumatisch
C 180 Kompressor C 200 CDI C 200 Kompressor	115 100 135	08/07→08/14 08/07→12/09 08/07→08/14		09/07→; für Linkslenker; für Fahrzeuge ohne Start-Stopp-Funktion		03.7745-6302.4	300261	ATE Ø 8" pneumatisch
C 220 CDI C 230 C 280 C 320 CDI C 320 CDI 4-matic C 350 C 350 CDI 4-matic	125 150 170 165 165 200 165	08/07→11/08 08/07→08/14 08/07→08/14 08/07→08/14 08/07→12/11 08/07→08/14 08/07→12/11		09/07→; für Linkslenker; für Fahrzeuge mit Start-Stopp-Funktion		03.7745-8902.4	300297	ATE Ø 8" pneumatisch
C 200 CGI C 250 CDI	135 150	08/07→08/14 01/09→08/14		04/09→; für Linkslenker; für Fahrzeuge ohne Start-Stopp-Funktion		03.7745-6302.4	300261	ATE Ø 8" pneumatisch
				04/09→; für Linkslenker; für Fahrzeuge mit Start-Stopp-Funktion		03.7745-8902.4	300297	ATE Ø 8" pneumatisch
C 220 CDI	120	08/07→11/08		09/07→; für Linkslenker; für Fahrzeuge ohne Start-Stopp-Funktion		03.7745-6302.4	300261	ATE Ø 8" pneumatisch
				für Linkslenker; für Fahrzeuge ohne Start-Stopp-Funktion		03.7745-6302.4	300261	ATE Ø 8" pneumatisch
				09/07→; für Linkslenker; für Fahrzeuge mit Start-Stopp-Funktion		03.7745-8902.4	300297	ATE Ø 8" pneumatisch
				für Linkslenker; für Fahrzeuge mit Start-Stopp-Funktion		03.7745-8902.4	300297	ATE Ø 8" pneumatisch
Hauptbremszylinder								
C 180 C 180 CDI C 180 CGI C 180 Kompressor C 200 CDI C 220 CDI	115 88 115 115 100 120 - 125	02/12→08/14 04/10→08/14 11/09→08/14 01/08→08/14 08/10→08/14 12/08→08/14		für Linkslenker		03.2025-2521.3	010959	ATE Ø1 25,4 Ø2 20,6
C 220 CDI 4-matic C 250 C 250 CDI 4-matic C 250 CGI C 300 C 300 CDI 4-matic C 350 CDI C 350 CDI 4-matic C 350 CGI C 63 AMG	125 150 150 150 170 170 165 - 195 170 225 336 - 383	02/13→08/14 02/08→12/12 04/10→08/14 07/09→08/14 08/07→08/14 06/11→08/14 08/07→08/14 10/09→08/14 06/11→08/14 02/08→08/14		für Rechtslenker		24.2025-2311.3	011023	ATE Ø1 25,4 Ø2 20,6
C 180 Kompressor C 200 CDI C 200 Kompressor	115 100 135	08/07→08/14 08/07→12/09 08/07→08/14		09/07→; für Linkslenker		03.2025-2521.3	010959	ATE Ø1 25,4 Ø2 20,6
C 220 CDI C 230 C 280 C 320 CDI C 320 CDI 4-matic C 350 C 350 CDI 4-matic	125 150 170 165 165 200 165	08/07→11/08 08/07→08/14 08/07→08/14 08/07→08/14 08/07→12/11 08/07→08/14 08/07→12/11		09/07→; für Rechtslenker		24.2025-2311.3	011023	ATE Ø1 25,4 Ø2 20,6
C 200 CGI C 250 CDI	135 150	08/07→08/14 01/09→08/14		04/09→; für Linkslenker		03.2025-2521.3	010959	ATE Ø1 25,4 Ø2 20,6
				04/09→; für Rechtslenker		24.2025-2311.3	011023	ATE Ø1 25,4 Ø2 20,6
C 220 CDI	120	08/07→11/08		09/07→; für Linkslenker		03.2025-2521.3	010959	ATE Ø1 25,4 Ø2 20,6
				für Linkslenker		03.2025-2521.3	010959	ATE Ø1 25,4 Ø2 20,6
				09/07→; für Rechtslenker		24.2025-2311.3	011023	ATE Ø1 25,4 Ø2 20,6
				für Rechtslenker		24.2025-2311.3	011023	ATE Ø1 25,4 Ø2 20,6
MERCEDES-BENZ - C-KLASSE T-Model (S205) 09/14→02/23								
Bremskraftverstärker								
AMG C 43 4-matic	270 - 287	04/16→02/21		Sonderausstattungscode (SA-Code) ab: 809 →		03.7845-2506.4	300329	ATE Ø 8" pneumatisch
C 160 C 180 C 180 d C 200 d C 200 EQ Boost C 200 EQ Boost 4-matic →	95 115 90 110 - 118 135 135	06/19→11/19 06/19→02/21 05/18→02/21 05/18→02/21 04/18→02/21 04/18→02/21				03.7845-2506.4	300329	ATE Ø 8" pneumatisch

MERCEDES-BENZ - C-KLASSE T-Model (S205) 09/14→02/23

 **Bremskraftverstärker**

C 220 d	143	04/18→02/21				03.7845-2506.4	300329	ATE Ø 8" pneumatisch
C 220 d 4-matic	143	05/18→02/21						
C 300	190	05/18→02/21						
C 300 4-matic	190	05/18→02/21						
C 300 d	180	06/18→02/21						
C 300 d 4-matic	180	06/18→02/21						
C 300 de	225	05/19→02/21						
C 300 e	235	07/19→02/21						
C 300 EQ Boost	190	05/19→02/21						
C 300 EQ Boost 4-matic	190	05/19→02/21						













 **Hauptbremszylinder**







AMG C 43 4-matic	270 - 287	04/16→02/21		für Linkslenker; +SA 805/806 / 807/808		24.4156-1136.3	011126	ATE Ø 27 ohne Bremsflüssigkeitsbehälter
				für Linkslenker; Sonderausstattungscode (SA-Code) ab: 809 →				24.4156-1221.3
AMG C 63	350	10/15→02/21		für Linkslenker		24.4156-1136.3	011126	ATE Ø 27 ohne Bremsflüssigkeitsbehälter
AMG C 63 S	375	10/15→02/21						
C 160	95	04/15→11/19						
C 180	115	09/14→08/20						
C 180 BlueTEC / d	85	09/14→05/18						
C 200	135	09/14→05/18						
C 200 4-matic	135	04/15→05/18						
C 200 BlueTEC / d	100	09/14→05/18						
C 200 d	100	10/15→05/18						
C 220 BlueTEC / d	120 - 125	09/14→05/18						
C 220 d 4-matic	125	04/15→05/18						
C 250	155	09/14→05/18						
C 250 BlueTEC / d	150	09/14→05/18						
C 250 BlueTEC / d 4-matic	150	10/14→05/18						
C 300	180	09/15→05/18						
C 300 BlueTEC Hybrid / h	150	10/14→05/18						
C 350 e	205	02/15→05/18						
C 400 4-matic	245	10/14→02/21						
C 450 AMG 4-matic	270	04/15→05/18						
C 160	95	06/19→11/19						
C 180	115	06/19→02/21						
C 180 d	90	05/18→02/21						
C 200 d	110 - 118	05/18→02/21						
C 200 EQ Boost	135	04/18→02/21						
C 200 EQ Boost 4-matic	135	04/18→02/21						
C 220 d	143	04/18→02/21						
C 220 d 4-matic	143	05/18→02/21						
C 300	190	05/18→02/21						
C 300 4-matic	190	05/18→02/21						
C 300 d	180	06/18→02/21						
C 300 d 4-matic	180	06/18→02/21						
C 300 de	225	05/19→02/21						
C 300 e	235	07/19→02/21						
C 300 EQ Boost	190	05/19→02/21						
C 300 EQ Boost 4-matic	190	05/19→02/21						













MERCEDES-BENZ - CLA Coupe (C117) 01/13→03/19

 **Hauptbremszylinder**













AMG CLA 45 4-matic	280	07/15→03/19		für Linkslenker		24.4123-1718.3	011016	TRW Ø 23,8 ohne Bremsflüssigkeitsbehälter
CLA 180	90	01/13→03/19						
CLA 180 CDI / d	80	10/13→05/18						
CLA 200	110 - 115	01/13→03/19						
CLA 200 CDI / d	100	07/14→03/19						
CLA 200 CDI / d 4-matic	100	07/14→03/19						
CLA 200 CDI	100	06/13→08/14						
CLA 220 4-matic	135	04/16→03/19						
CLA 220 CDI / d	120 - 130	01/13→03/19						
CLA 220 CDI / d 4-matic	120 - 130	08/14→03/19						
CLA 220 CDI 4-matic	125	07/14→03/19						
CLA 250	155 - 160	01/13→03/19						
CLA 250 4-matic	155 - 160	07/13→03/19						
CLA 45 AMG 4-matic	265	07/13→03/19						











	kw			 	! #		
MERCEDES-BENZ - CLA Shooting Brake (X117) 01/15→03/19							
 Hauptbremszylinder							
AMG CLA 45 4-matic	280	07/15→03/19		für Linkslenker		24.4123-1718.3 011016	TRW Ø 23,8 ohne Bremsflüssigkeitsbehälter
CLA 180	90	01/15→03/19					
CLA 180 d	80	07/15→05/18					
CLA 200	115	01/15→03/19					
CLA 200 CDI / d	100	01/15→03/19					
CLA 200 CDI / d 4-matic	100	01/15→03/19					
CLA 220 4-matic	135	04/16→03/19					
CLA 220 CDI / d	120 - 130	01/15→03/19					
CLA 220 CDI / d 4-matic	120 - 130	01/15→03/19					
CLA 220 d	125	07/18→03/19					
CLA 220 d 4-matic	125	07/18→03/19					
CLA 250	155	01/15→03/19					
CLA 250 4-matic	155 - 160	01/15→03/19					
CLA 45 AMG 4-matic	265	01/15→07/15					
MERCEDES-BENZ - CLC-KLASSE (CL203) 05/08→06/11							
 Bremskraftverstärker							
CLC 160	95	02/09→06/11		→ 10/10; für Linkslenker		03.7848-2002.4 300166	ATE Ø 7 / 8" pneumatisch
CLC 180 Kompressor	105	05/08→06/11					
CLC 200 CDI	90	05/08→06/11					
CLC 200 Kompressor	135	05/08→06/11					
CLC 220 CDI	100 - 110	05/08→06/11					
CLC 350	200	05/08→06/11					
CLC 230	150	05/08→06/11		für Linkslenker		03.7848-2002.4 300166	ATE Ø 7 / 8" pneumatisch
CLC 250	150	06/09→06/11					
Pedalwegsensoren, Bremspedal							
CLC 160	95	02/09→06/11		→ 10/10		03.0655-0007.2 370007	ATE
CLC 180 Kompressor	105	05/08→06/11					
CLC 200 CDI	90	05/08→06/11					
CLC 200 Kompressor	135	05/08→06/11					
CLC 220 CDI	100 - 110	05/08→06/11					
CLC 350	200	05/08→06/11					
CLC 230	150	05/08→06/11				03.0655-0007.2 370007	ATE
CLC 250	150	06/09→06/11					
 Hauptbremszylinder							
CLC 160	95	02/09→06/11		→ 10/10; für Linkslenker		03.2023-1741.3 010703	ATE Ø1 23,8 Ø2 20,6
CLC 180 Kompressor	105	05/08→06/11					
CLC 200 CDI	90	05/08→06/11					
CLC 200 Kompressor	135	05/08→06/11					
CLC 220 CDI	100 - 110	05/08→06/11					
CLC 230	150	05/08→06/11		für Linkslenker		03.2025-1741.3 010705	ATE Ø1 25,4 Ø2 20,6
CLC 250	150	06/09→06/11					
CLC 350	200	05/08→06/11		→ 10/10; für Linkslenker		03.2025-1741.3 010705	ATE Ø1 25,4 Ø2 20,6
MERCEDES-BENZ - CLK (C208) 06/97→12/03							
Pedalwegsensoren, Bremspedal							
CLK 200	100	06/97→06/02		F 129679→		03.0655-0007.2 370007	ATE
CLK 200 Kompressor	141	06/97→06/00					
CLK 230 Kompressor	142	06/97→06/00					
CLK 200 Kompressor	120	06/00→06/02				03.0655-0007.2 370007	ATE
CLK 230 Kompressor	145	06/00→06/02					
 Hauptbremszylinder							
CLK 200	100	06/97→06/02		F 129679→; für Linkslenker		03.2023-2004.3 010788	ATE Ø1 23,8 Ø2 19
CLK 200 Kompressor	141	06/97→06/00					
CLK 230 Kompressor	142	06/97→06/00		→ F 129678; - ESP		24.2023-1702.3 010534	TRW Ø1 23,8 Ø2 19
CLK 200 Kompressor	120	06/00→06/02		für Linkslenker		03.2023-2004.3 010788	ATE Ø1 23,8 Ø2 19
CLK 230 Kompressor	145	06/00→06/02					
CLK 320	160	06/97→06/02		→ F 129678; - ESP		24.2023-1702.3 010534	TRW Ø1 23,8 Ø2 19
				F 129679→		24.2023-1704.3 010635	TRW Ø 23,8
				→ F 129678; + ESP		24.2023-1704.3 010635	TRW Ø 23,8
CLK 430	205	07/98→06/02				24.2025-1709.3 010693	Ø 25,4
CLK 55 AMG	255	08/99→06/02					
MERCEDES-BENZ - CLK (C209) 05/02→03/10							
 Bremskraftverstärker							
CLK 200 CGI →	125	07/03→05/09		→ 04/09; für Linkslenker		03.7848-2002.4 300166	ATE Ø 7 / 8" pneumatisch

	kw			 	! #		
MERCEDES-BENZ - CLK (C209) 05/02→03/10							
Bremskraftverstärker							
CLK 200 Kompressor	120 - 135	09/02→05/09		→ 04/09; für Linkslenker		03.7848-2002.4 300166	ATE Ø 7 / 8" pneumatisch
CLK 240	120 - 125	06/02→05/09					
CLK 270 CDI	125	10/02→05/09					
CLK 320	160	06/02→05/09					
CLK 500	225 - 285	06/02→05/09					
CLK 55 AMG	270	09/02→05/09					
CLK 63 AMG	354 - 373	04/06→05/09					
CLK 220 CDI	100 - 110	01/05→05/09		05/05→ 04/09; für Linkslenker		03.7848-2002.4 300166	ATE Ø 7 / 8" pneumatisch
CLK 280	170	01/05→05/09					
CLK 320 CDI	165	01/05→05/09					
CLK 350	200	01/05→05/09					
CLK 270 CDI	120	02/03→06/05		für Linkslenker		03.7848-2002.4 300166	ATE Ø 7 / 8" pneumatisch
Pedalwegsensord, Bremspedal							
CLK 200 CGI	125	07/03→05/09		→ 04/09		03.0655-0007.2 370007	ATE
CLK 200 Kompressor	120 - 135	09/02→05/09					
CLK 240	120 - 125	06/02→05/09					
CLK 270 CDI	125	10/02→05/09					
CLK 320	160	06/02→05/09					
CLK 500	225 - 285	06/02→05/09					
CLK 55 AMG	270	09/02→05/09					
CLK 63 AMG	354 - 373	04/06→05/09					
CLK 220 CDI	100 - 110	01/05→05/09		05/05→ 04/09		03.0655-0007.2 370007	ATE
CLK 280	170	01/05→05/09					
CLK 320 CDI	165	01/05→05/09					
CLK 350	200	01/05→05/09					
CLK 270 CDI	120	02/03→06/05				03.0655-0007.2 370007	ATE
Hauptbremszylinder							
CLK 200 CGI	125	07/03→05/09		→ 04/09; für Linkslenker; für Fahrzeuge ohne Sportpaket / für Fahrzeuge ohne AMG-Sportpaket		03.2023-1741.3 010703	ATE Ø1 23,8 Ø2 20,6
CLK 200 Kompressor	120	09/02→05/09					
CLK 270 CDI	125	10/02→05/09		→ 04/09; für Linkslenker; für Fahrzeuge mit Sportpaket / für Fahrzeuge mit AMG-Sportpaket		03.2025-1741.3 010705	ATE Ø1 25,4 Ø2 20,6
CLK 200 Kompressor	135	10/06→05/09		→ 04/09; für Linkslenker; für Fahrzeuge ohne AMG-Sportpaket / für Fahrzeuge ohne Sportpaket		03.2023-1741.3 010703	ATE Ø1 23,8 Ø2 20,6
				→ 04/09; für Linkslenker; für Fahrzeuge mit Sportpaket / für Fahrzeuge mit AMG-Sportpaket		03.2025-1741.3 010705	ATE Ø1 25,4 Ø2 20,6
CLK 220 CDI	100 - 110	01/05→05/09		05/05→ 04/09; für Linkslenker		03.2025-1741.3 010705	ATE Ø1 25,4 Ø2 20,6
CLK 280	170	01/05→05/09					
CLK 320 CDI	165	01/05→05/09					
CLK 350	200	01/05→05/09					
CLK 240	120 - 125	06/02→05/09		→ 04/09; für Linkslenker		03.2025-1741.3 010705	ATE Ø1 25,4 Ø2 20,6
CLK 320	160	06/02→05/09					
CLK 500	225 - 285	06/02→05/09					
CLK 55 AMG	270	09/02→05/09					
CLK 63 AMG	354 - 373	04/06→05/09					
CLK 270 CDI	120	02/03→06/05		für Linkslenker; für Fahrzeuge ohne Sportpaket / für Fahrzeuge ohne AMG-Sportpaket		03.2023-1741.3 010703	ATE Ø1 23,8 Ø2 20,6
				für Linkslenker; für Fahrzeuge mit Sportpaket / für Fahrzeuge mit AMG-Sportpaket		03.2025-1741.3 010705	ATE Ø1 25,4 Ø2 20,6
MERCEDES-BENZ - CLK Cabriolet (A208) 03/98→03/02							
Pedalwegsensord, Bremspedal							
CLK 200	100	03/98→03/02		T 028296→		03.0655-0007.2 370007	ATE
CLK 200 Kompressor	141	03/98→06/00					
CLK 230 Kompressor	142	03/98→06/00					
CLK 200 Kompressor	120	06/00→03/02		T 028296→		03.0655-0007.2 370007	ATE
CLK 230 Kompressor	145	06/00→03/02				03.0655-0007.2 370007	ATE
→							











	kw					! #		
MERCEDES-BENZ - CLK Cabriolet (A208) 03/98→03/02								
 Hauptbremszylinder								
CLK 200	100	03/98→03/02		T 028296→; für Linkslenker		03.2023-2004.3	010788	ATE Ø1 23,8 Ø2 19
CLK 200 Kompressor	141	03/98→06/00		06/98→; → T 028295; - ESP		24.2023-1702.3	010534	TRW Ø1 23,8 Ø2 19
CLK 230 Kompressor	142	03/98→06/00						
CLK 200 Kompressor	120	06/00→03/02		für Linkslenker		03.2023-2004.3	010788	ATE Ø1 23,8 Ø2 19
CLK 230 Kompressor	145	06/00→03/02		T 028296→; für Linkslenker		03.2023-2004.3	010788	ATE Ø1 23,8 Ø2 19
				→ T 028295; - ESP		24.2023-1702.3	010534	TRW Ø1 23,8 Ø2 19
CLK 320	160	03/98→03/02		06/98→; → T 028295; - ESP		24.2023-1702.3	010534	TRW Ø1 23,8 Ø2 19
				T 028296→		24.2023-1704.3	010635	TRW Ø 23,8
				06/98→; → T 028295; + ESP		24.2023-1704.3	010635	TRW Ø 23,8
CLK 430	205	09/98→03/02		06/99→		24.2025-1709.3	010693	Ø 25,4
CLK 55 AMG	255	01/00→03/02				24.2025-1709.3	010693	Ø 25,4
MERCEDES-BENZ - CLK Cabriolet (A209) 06/02→03/10								
 Bremskraftverstärker								
CLK 200 CGI	125	07/03→03/10		→ 12/09; für Linkslenker		03.7848-2002.4	300166	ATE Ø 7 / 8" pneumatisch
CLK 200 Kompressor	135	10/06→03/10						
CLK 500	285	06/06→03/10						
CLK 63 AMG	354	04/06→03/10						
CLK 200 Kompressor	120	02/03→03/10		05/03→ 12/09; für Linkslenker		03.7848-2002.4	300166	ATE Ø 7 / 8" pneumatisch
CLK 240	125	02/03→03/10						
CLK 320	160	02/03→03/10						
CLK 500	225	02/03→03/10						
CLK 55 AMG	270	06/02→03/10						
CLK 280	170	01/05→03/10		05/05→ 12/09; für Linkslenker		03.7848-2002.4	300166	ATE Ø 7 / 8" pneumatisch
CLK 320 CDI	165	03/05→03/10						
CLK 350	200	01/05→03/10						
CLK 63 AMG	354	09/06→12/09		für Linkslenker		03.7848-2002.4	300166	ATE Ø 7 / 8" pneumatisch
Pedalwegsensoren, Bremspedal								
CLK 200 CGI	125	07/03→03/10		→ 12/09		03.0655-0007.2	370007	ATE
CLK 200 Kompressor	135	10/06→03/10						
CLK 500	285	06/06→03/10						
CLK 63 AMG	354	04/06→03/10						
CLK 200 Kompressor	120	02/03→03/10		05/03→ 12/09		03.0655-0007.2	370007	ATE
CLK 240	125	02/03→03/10						
CLK 320	160	02/03→03/10						
CLK 500	225	02/03→03/10						
CLK 55 AMG	270	06/02→03/10						
CLK 280	170	01/05→03/10		05/05→ 12/09		03.0655-0007.2	370007	ATE
CLK 320 CDI	165	03/05→03/10						
CLK 350	200	01/05→03/10						
CLK 63 AMG	354	09/06→12/09				03.0655-0007.2	370007	ATE
 Hauptbremszylinder								
CLK 200 CGI	125	07/03→03/10		→ 12/09; für Linkslenker		03.2023-1741.3	010703	ATE Ø1 23,8 Ø2 20,6
CLK 200 Kompressor	135	10/06→03/10		→ 12/09; für Linkslenker		03.2025-1741.3	010705	ATE Ø1 25,4 Ø2 20,6
CLK 500	285	06/06→03/10						
CLK 63 AMG	354	04/06→03/10						
CLK 200 Kompressor	120	02/03→03/10		05/03→ 12/09; für Linkslenker		03.2025-1741.3	010705	ATE Ø1 25,4 Ø2 20,6
CLK 240	125	02/03→03/10						
CLK 320	160	02/03→03/10						
CLK 500	225	02/03→03/10						
CLK 55 AMG	270	06/02→03/10						
CLK 280	170	01/05→03/10		05/05→ 12/09; für Linkslenker		03.2025-1741.3	010705	ATE Ø1 25,4 Ø2 20,6
CLK 320 CDI	165	03/05→03/10						
CLK 350	200	01/05→03/10						
CLK 63 AMG	354	09/06→12/09		für Linkslenker		03.2025-1741.3	010705	ATE Ø1 25,4 Ø2 20,6
MERCEDES-BENZ - CLS (C218) 01/11→12/17								
 Bremskraftverstärker								
CLS 250 CDI / BlueTEC / d	150	04/11→12/17		für Linkslenker		03.7755-8202.4	300301	ATE Ø 9 / 8" pneumatisch
CLS 350	225	01/11→08/14						
CLS 350 CDI / d	195	01/11→08/14						
CLS 350 CDI / d 4-matic	195	09/11→08/14						
CLS 350 d 4-matic	190	04/15→12/17						
CLS 500	300	02/11→12/17						
CLS 500 4-matic	300	09/11→12/17						
CLS 63 AMG	410	01/11→12/17						
CLS 63 AMG	386	01/11→12/17		03/11→; für Linkslenker		03.7755-8202.4	300301	ATE Ø 9 / 8" pneumatisch
 Hauptbremszylinder								
CLS 220 BlueTEC / d	120 - 130	05/14→12/17		für Linkslenker		03.2126-3196.3	010968	ATE Ø 27























	kW					! #		
MERCEDES-BENZ - CLS (C218) 01/11→12/17								
 Hauptbremszylinder								
CLS 250 BlueTEC / d 4-matic	150	05/14→12/17		für Linkslenker			03.2126-3196.3 010968	ATE Ø 27
CLS 350 BlueTEC / d 4-matic	185	02/13→12/17						
CLS 350 CDI / d 4-matic	195	09/11→08/14						
CLS 350 d 4-matic	190	04/15→12/17						
CLS 63 AMG 4-matic	410 - 430	02/13→12/17						
CLS 250 CDI / BlueTEC / d	150	04/11→12/17		für Linkslenker			03.2126-3196.3 010968	ATE Ø 27
CLS 350	225	01/11→08/14		für Rechtslenker			24.2127-0901.3 011139	ATE Ø 27 ohne Bremsflüssigkeitsbehälter
CLS 350 BlueTEC / d	185 - 190	02/13→12/17						
CLS 350 CDI / d	195	01/11→08/14						
CLS 400	245	05/14→12/17						
CLS 400 4-matic	245	05/14→12/17						
CLS 500	300	02/11→12/17						
CLS 500 4-matic	300	09/11→12/17						
CLS 63 AMG	410 - 430	01/11→12/17						
CLS 63 AMG	386	01/11→12/17		03/11→; für Linkslenker			03.2126-3196.3 010968	ATE Ø 27
				03/11→; für Rechtslenker			24.2127-0901.3 011139	ATE Ø 27 ohne Bremsflüssigkeitsbehälter
MERCEDES-BENZ - CLS (C219) 10/04→02/11								
 Hauptbremszylinder								
CLS 280	170	07/08→12/10		→ 10/10; für Linkslenker			24.2125-1745.3 010998	TRW Ø 25,4
CLS 300	170	04/09→12/10						
CLS 350	200 - 215	10/04→12/10		→ 10/10; für Rechtslenker			24.2125-1748.3 011030	TRW Ø 25,4
CLS 350 CDI	165 - 200	04/09→12/10						
CLS 500	225 - 285	10/04→12/10						
CLS 55 AMG	350	01/05→12/10						
CLS 63 AMG	378	04/06→12/10						
CLS 320 CDI	155 - 165	01/05→12/10		05/05→ 10/10; für Linkslenker			24.2125-1745.3 010998	TRW Ø 25,4
				05/05→ 10/10; für Rechtslenker			24.2125-1748.3 011030	TRW Ø 25,4
CLS 55 AMG	350	09/05→12/06		für Linkslenker			24.2125-1745.3 010998	TRW Ø 25,4
				für Rechtslenker			24.2125-1748.3 011030	TRW Ø 25,4
MERCEDES-BENZ - CLS (C257) 12/17→								
 Hauptbremszylinder								
AMG CLS 53 EQ Boost 4-matic+	320	05/18→		für Linkslenker			24.4156-1221.3 011127	ATE Ø 27 ohne Bremsflüssigkeitsbehälter
CLS 220 d	143	06/18→						
CLS 300 d	180	04/18→						
CLS 300 d 4-matic	195	04/21→						
CLS 350 d	210	08/18→						
CLS 350 d 4-matic	183 - 210	12/17→						
CLS 350 EQ Boost	220	08/18→						
CLS 350 EQ Boost 4-matic	220	08/18→						
CLS 400 d 4-matic	243 - 250	12/17→						
CLS 450 EQ Boost 4-matic	270	12/17→						
MERCEDES-BENZ - CLS Shooting Brake (X218) 10/12→12/17								
 Bremskraftverstärker								
CLS 250 CDI / BlueTEC / d	150	10/12→12/17		→ A 26541; für Linkslenker			03.7858-1932.4 300263	ATE Ø 9 / 8" pneumatisch
CLS 350	225	10/12→08/14						
CLS 350 CDI / d	195	10/12→08/14						
CLS 350 CDI / d 4-matic	195	10/12→08/14						
 Hauptbremszylinder								
CLS 220 BlueTEC / d	120 - 130	05/14→12/17		für Linkslenker			03.2126-3196.3 010968	ATE Ø 27
CLS 250 BlueTEC / d 4-matic	150	05/14→12/17		für Rechtslenker			24.2127-0901.3 011139	ATE Ø 27 ohne Bremsflüssigkeitsbehälter
CLS 250 CDI / BlueTEC / d	150	10/12→12/17						
CLS 350	225	10/12→08/14						
CLS 350 BlueTEC / d	185 - 190	05/14→12/17						
→								













	kw			 	! #		
MERCEDES-BENZ - CLS Shooting Brake (X218) 10/12→12/17							
 Hauptbremszylinder							
CLS 350 BlueTEC / d 4-matic	185	05/14→12/17		für Linkslenker		03.2126-3196.3 010968	ATE Ø 27
CLS 350 CDI / d	195	10/12→08/14		für Rechtslenker		24.2127-0901.3 011139	ATE Ø 27 ohne Bremsflüssigkeitsbehälter
CLS 350 CDI / d 4-matic	195	10/12→08/14					
CLS 400	245	05/14→12/17					
CLS 400 4-matic	245	05/14→12/17					
CLS 500	300	10/12→12/17					
CLS 500 4-matic	300	10/12→12/17					
CLS 63 AMG	386 - 430	10/12→12/17					
CLS 63 AMG 4-matic	410 - 430	02/13→12/17					
CLS 350 d 4-matic	190	04/15→12/17		für Linkslenker		03.2126-3196.3 010968	ATE Ø 27
MERCEDES-BENZ - E-KLASSE (W210) 06/95→08/03							
 Hauptbremszylinder							
E 200	100	06/95→08/00		→ A394035		03.2023-1066.3 010032	Ø1 23,8 Ø2 19
				A394036→		03.2023-1812.3 010570	Ø1 23,8 Ø2 19
E 200 CDI	75	06/98→03/02		07/98→		03.2023-1812.3 010570	Ø1 23,8 Ø2 19
E 200 CDI	85	07/99→03/02				03.2023-1812.3 010570	Ø1 23,8 Ø2 19
E 220 CDI	100 - 105	07/99→03/02					
E 200 D	65	01/96→03/02		10/96→; → A394035		03.2023-1066.3 010032	Ø1 23,8 Ø2 19
				A394036→		03.2023-1812.3 010570	Ø1 23,8 Ø2 19
E 200 Kompressor	137	06/97→03/02		09/97→		24.2025-1703.3 010516	Ø1 25,4 Ø2 19
E 430	205	06/97→03/02					
E 55 AMG	260	08/97→03/02					
E 200 Kompressor	120	08/00→03/02				24.2025-1703.3 010516	Ø1 25,4 Ø2 19
E 270 CDI	120 - 125	07/99→03/02					
E 280	150	12/96→03/02					
E 280 4-matic	150	12/96→03/02					
E 320	165	06/97→03/02					
E 320 4-matic	165	06/97→03/02					
E 320 CDI	145	07/99→03/02					
E 430 4-matic	205	05/99→03/02					
E 220 D	55	05/96→03/02		→ A394035		03.2023-1066.3 010032	Ø1 23,8 Ø2 19
				→ 06/98; A394036→		03.2023-1812.3 010570	Ø1 23,8 Ø2 19
E 240	125	06/97→08/00		09/97→; - ESP		03.2023-1812.3 010570	Ø1 23,8 Ø2 19
				09/97→; + ESP		24.2025-1703.3 010516	Ø1 25,4 Ø2 19
E 240	125	08/00→03/02		- ESP		03.2023-1812.3 010570	Ø1 23,8 Ø2 19
				+ ESP		24.2025-1703.3 010516	Ø1 25,4 Ø2 19
MERCEDES-BENZ - E-KLASSE (W211) 03/02→03/09							
 Hauptbremszylinder							
E 200 CDI	75 - 100	07/02→12/08		für Linkslenker		24.2125-1745.3 010998	TRW Ø 25,4
E 200 Kompressor	120 - 135	11/02→12/08		für Rechtslenker		24.2125-1748.3 011030	TRW Ø 25,4
E 200 NGT	120	03/04→12/08					
E 220 CDI	100 - 125	03/02→12/08					
E 230	150	09/07→12/08					
E 240	130	03/02→12/08					
E 240 4-matic	130	03/03→12/08					
E 270 CDI	120 - 130	03/02→12/08					
E 280 4-matic	170	01/06→12/08					
E 280 CDI	130 - 140	05/04→12/08					
E 280 CDI 4-matic	140	03/05→12/08					
E 300 BlueTEC	155	09/07→12/08					
E 320	165	03/02→12/08					
E 320 4-matic	165	03/03→12/08					
E320 CDI	156	09/06→12/08					
E 320 CDI	150 - 165	11/02→12/08					
E 320 CDI 4-matic	165	03/05→12/08					
E 350	200	03/05→12/08					
E 350 4-matic	200	03/05→12/08					
E 350 CGI	215	09/07→12/08					
E 420 CDI	231	01/06→12/08					
E 500	225 - 285	03/02→12/08					
E 500 4-matic	225 - 285	10/03→12/08					
→							



	kw					! #		
MERCEDES-BENZ - E-KLASSE (W211) 03/02→03/09								
 Hauptbremszylinder								
E 55 AMG Kompressor E 63 AMG	350 378	10/02→12/08 03/06→12/08		für Linkslenker		24.2125-1745.3 010998		TRW Ø 25,4
				für Rechtslenker		24.2125-1748.3 011030		TRW Ø 25,4
E 280	170	03/05→12/08		05/05→; für Linkslenker		24.2125-1745.3 010998		TRW Ø 25,4
				05/05→; für Rechtslenker		24.2125-1748.3 011030		TRW Ø 25,4
E 400 CDI	191	02/03→12/08		03/03→; für Linkslenker		24.2125-1745.3 010998		TRW Ø 25,4
				03/03→; für Rechtslenker		24.2125-1748.3 011030		TRW Ø 25,4
MERCEDES-BENZ - E-KLASSE (W212) 01/09→12/16								
 Bremskraftverstärker								
E 180 E 200 E 200 CGI E 200 NGT	115 135 135 115 - 120	08/13→12/15 01/13→12/16 08/09→12/15 03/11→12/15		für Linkslenker		03.7755-8202.4 300301		ATE Ø 9 / 8" pneumatisch
E 220 BlueTEC E 220 BlueTEC 4-matic E 250 E 250 CDI / BlueTEC 4-matic E 300 E 300 4-matic E 350 E 350 4-matic E 350 BlueTEC	130 125 155 150 185 185 225 225 185 - 190	05/14→12/15 01/15→12/15 01/13→12/16 01/11→12/15 07/11→12/15 07/11→12/15 09/11→12/15 09/11→12/15 01/13→12/15						
E 350 BlueTEC 4-matic E 350 CDI E 350 CDI 4-matic	185 - 190 157 - 195 170 - 195	01/13→12/15 09/10→12/15 09/09→12/15						
E 400 E 400 4-matic E 500 E 500 4-matic E 63 AMG E 63 AMG 4-matic	245 245 300 300 386 - 410 410	01/13→12/16 01/13→12/16 09/11→12/15 09/11→12/15 12/09→12/16 01/13→12/16						
E 200 CDI / BlueTEC E 220 CDI E 220 CDI / BlueTEC E 250 CDI / BlueTEC E 250 CGI E 300 E 350 E 350 4-matic E 350 BlueTEC E 350 CDI E 350 CGI E 500 E 500 4-matic	100 120 125 150 150 170 200 200 155 170 215 285 285	01/09→12/15 01/09→12/15 01/09→12/16 01/09→12/16 01/09→12/15 01/09→12/13 01/09→12/13 01/09→08/11 01/09→12/15 01/09→12/15 01/09→08/11 01/09→12/11 01/09→12/11		03/09→; für Linkslenker		03.7755-8202.4 300301		ATE Ø 9 / 8" pneumatisch
E 250 E 300 CDI / BlueTEC E 63 AMG E 63 AMG 4-matic	150 170 430 430	05/09→12/11 03/11→12/15 02/13→12/16 02/13→12/16		für Linkslenker; +SA 800 04/11→; für Linkslenker 04/13→; für Linkslenker		03.7755-8202.4 300301 03.7755-8202.4 300301 03.7755-8202.4 300301		ATE Ø 9 / 8" pneumatisch ATE Ø 9 / 8" pneumatisch ATE Ø 9 / 8" pneumatisch
 Hauptbremszylinder								
E 180 E 200 E 200 CGI E 200 NGT	115 135 135 115 - 120	08/13→12/15 01/13→12/16 08/09→12/15 03/11→12/15		für Linkslenker		03.2126-3196.3 010968		ATE Ø 27
				für Rechtslenker		03.4156-5106.3 010997		ATE Ø 27
E 220 BlueTEC E 220 BlueTEC 4-matic E 250 E 250 CDI / BlueTEC 4-matic E 250 CGI E 300 E 300 4-matic E 350 E 350 4-matic E 350 BlueTEC	130 125 155 150 150 185 185 225 225 185 - 190	05/14→12/15 01/15→12/15 01/13→12/16 01/11→12/15 01/09→12/15 07/11→12/15 07/11→12/15 09/11→12/15 09/11→12/15 01/13→12/15						
E 350 BlueTEC 4-matic E 350 CDI	185 - 190 157 - 195	01/13→12/15 09/10→12/15						
→								

	kW			 	! #		
MERCEDES-BENZ - E-KLASSE (W212) 01/09→12/16							
 Hauptbremszylinder							
E 350 CDI 4-matic	170 - 195	09/09→12/15		für Linkslenker		03.2126-3196.3 010968	ATE Ø 27
E 400	245	01/13→12/16				03.4156-5106.3 010997	ATE Ø 27
E 400 4-matic	245	01/13→12/16		für Rechtslenker		24.2127-0901.3 011139	ATE Ø 27 ohne Bremsflüssigkeitsbehälter
E 500	300	09/11→12/15					
E 500 4-matic	300	09/11→12/15					
E 63 AMG	386 - 410	12/09→12/16					
E 63 AMG 4-matic	410	01/13→12/16					
E 200 CDI / BlueTEC	100	01/09→12/15		03/09→; für Linkslenker		03.2126-3196.3 010968	ATE Ø 27
E 220 CDI	120	01/09→12/15				03.4156-5106.3 010997	ATE Ø 27
E 220 CDI / BlueTEC	125	01/09→12/16					
E 250 CDI / BlueTEC	150	01/09→12/16		03/09→; für Rechtslenker		24.2127-0901.3 011139	ATE Ø 27 ohne Bremsflüssigkeitsbehälter
E 300	170	01/09→12/13					
E 350	200	01/09→12/13					
E 350 4-matic	200	01/09→08/11					
E 350 BlueTEC	155	01/09→12/15					
E 350 CDI	170	01/09→12/15					
E 350 CGI	215	01/09→08/11					
E 500	285	01/09→12/11					
E 500 4-matic	285	01/09→12/11					
E 250	150	05/09→12/11		für Linkslenker; → Sonderausstattungscode (SA-Code) bis: 803		03.2126-3196.3 010968	ATE Ø 27
				für Linkslenker; Sonderausstattungscode (SA-Code) ab: 804 →		03.4156-5106.3 010997	ATE Ø 27
				für Rechtslenker; → Sonderausstattungscode (SA-Code) bis: 803		24.2127-0901.3 011139	ATE Ø 27 ohne Bremsflüssigkeitsbehälter
E 300 CDI / BlueTEC	170	03/11→12/15		04/11→; für Linkslenker		03.2126-3196.3 010968	ATE Ø 27
						03.4156-5106.3 010997	ATE Ø 27
				04/11→; für Rechtslenker		24.2127-0901.3 011139	ATE Ø 27 ohne Bremsflüssigkeitsbehälter
E 300 CDI	150	12/09→12/10		für Rechtslenker		24.2127-0901.3 011139	ATE Ø 27 ohne Bremsflüssigkeitsbehälter
E 63 AMG	430	02/13→12/16		04/13→; für Linkslenker		03.2126-3196.3 010968	ATE Ø 27
E 63 AMG 4-matic	430	02/13→12/16				03.4156-5106.3 010997	ATE Ø 27
				04/13→; für Rechtslenker		24.2127-0901.3 011139	ATE Ø 27 ohne Bremsflüssigkeitsbehälter
MERCEDES-BENZ - E-KLASSE (W213) 01/16→							
 Hauptbremszylinder							
AMG E 43 4-matic	295	07/16→05/18		für Linkslenker		24.4156-1221.3 011127	ATE Ø 27 ohne Bremsflüssigkeitsbehälter
AMG E 53 EQ Boost 4-matic+	320	04/18→10/23					
E 180	115	01/17→06/19					
E 200	135 - 145	01/16→10/23					
E 200 4-matic	135	07/16→06/19					
E 200 d	110	07/16→06/20					
E 200 EQ Boost	145	06/19→10/23					
E 200 EQ Boost 4-matic	145	06/19→10/23					
E 220 d	120 - 147	01/16→10/23					
E 220 d 4-matic	120 - 147	10/16→10/23					
E 250	155	07/16→10/23					
E 300	180 - 190	07/16→10/23					
E 300 4-matic	180	09/16→06/20					
E 300 d	180	12/17→06/20					
E 300 d 4-matic	195	01/21→10/23					
E 300 de	225	10/18→10/23					
E 300 de 4-matic	225	06/20→08/23					
E 300 e	235	11/18→10/23					
E 300 e 4-matic	235	07/20→10/23					
E 300 EQ Boost	190	06/19→10/23					
E 350 d	190 - 210	01/16→06/20					
E 350 d 4-matic	190	06/17→05/18					
E 350 e	235	09/16→06/19					
E 350 EQ Boost	220	08/18→10/23					
E 400 4-matic	245	07/16→05/18					
E 400 d	250	12/18→06/20					
E 400 d 4-matic	243 - 250	04/18→10/23					
E 450 4-matic	270	08/18→06/20					
E 450 EQ Boost 4-matic	270	07/20→10/23					
AMG E 63 4-matic+	420	01/17→11/21		für Linkslenker; → A; → 08/17		24.4156-1136.3 011126	ATE Ø 27 ohne Bremsflüssigkeitsbehälter
AMG E 63 S 4-matic+	450	01/17→10/23					
→							

	kw			 	! #		
MERCEDES-BENZ - E-KLASSE (W213) 01/16→							
 Hauptbremszylinder							
E 400 4-matic	245	06/16→05/18		07/16→; für Linkslenker		24.4156-1221.3 011127	ATE Ø 27 ohne Bremsflüssigkeitsbehälter
MERCEDES-BENZ - E-KLASSE All-Terrain (S213) 01/17→10/23							
 Hauptbremszylinder							
E 200 EQ Boost	145	08/20→08/23		für Linkslenker		24.4156-1221.3 011127	ATE Ø 27 ohne Bremsflüssigkeitsbehälter
E 220 d 4-matic	143 - 147	01/17→10/23					
E 350 d 4-matic	190	06/17→05/18					
E 400 d 4-matic	243 - 250	08/18→10/23					
E 450 EQ Boost	270	08/20→08/23					
MERCEDES-BENZ - E-KLASSE Cabriolet (A207) 01/10→12/16							
 Bremskraftverstärker							
E 200	135	03/13→12/16		für Linkslenker; für Fahrzeuge ohne Start-Stopp-Funktion		03.7745-6302.4 300261	ATE Ø 8" pneumatisch
E 220 BlueTEC	130	05/14→12/16					
E 250	155	06/13→12/16		für Linkslenker; für Fahrzeuge mit Start-Stopp-Funktion		03.7745-8902.4 300297	ATE Ø 8" pneumatisch
E 300	185	04/11→12/16					
E 320	200	07/14→12/16					
E 350	200 - 225	03/10→12/14					
E 350 BlueTEC/ d	190	05/14→12/16					
E 350 BlueTEC	185	06/13→12/16					
E 350 CDI	195	04/11→12/13					
E 350 CGI	215	01/10→12/14					
E 400	245	06/13→12/16					
E 500	300	09/11→12/16					
E 200 CGI	135	01/10→12/16		03/10→; für Linkslenker; für Fahrzeuge ohne Start-Stopp-Funktion		03.7745-6302.4 300261	ATE Ø 8" pneumatisch
E 220 CDI / BlueTEC / d	125	01/10→12/16					
E 220 CDI	120	02/10→12/16		03/10→; für Linkslenker; für Fahrzeuge mit Start-Stopp-Funktion		03.7745-8902.4 300297	ATE Ø 8" pneumatisch
E 250 CDI / BlueTEC / d	150	01/10→12/16					
E 250 CGI	150	01/10→12/16					
E 350 CDI	170	01/10→12/11					
E 500	285	01/10→12/11					
 Hauptbremszylinder							
E 200	135	03/13→12/16		für Linkslenker		03.2025-2521.3 010959	ATE Ø1 25,4 Ø2 20,6
E 220 BlueTEC	130	05/14→12/16		für Rechtslenker		24.2025-2311.3 011023	ATE Ø1 25,4 Ø2 20,6
E 250	155	06/13→12/16					
E 300	185	04/11→12/16					
E 320	200	07/14→12/16					
E 350	200 - 225	03/10→12/14					
E 350 BlueTEC/ d	190	05/14→12/16					
E 350 BlueTEC	185	06/13→12/16					
E 350 CDI	195	04/11→12/13					
E 350 CGI	215	01/10→12/14					
E 400	245	06/13→12/16					
E 500	300	09/11→12/16					
E 200 CGI	135	01/10→12/16		03/10→; für Linkslenker		03.2025-2521.3 010959	ATE Ø1 25,4 Ø2 20,6
E 220 CDI / BlueTEC / d	125	01/10→12/16					
E 220 CDI	120	02/10→12/16		03/10→; für Rechtslenker		24.2025-2311.3 011023	ATE Ø1 25,4 Ø2 20,6
E 250 CDI / BlueTEC / d	150	01/10→12/16					
E 250 CGI	150	01/10→12/16					
E 350 CDI	170	01/10→12/11					
E 500	285	01/10→12/11					
MERCEDES-BENZ - E-KLASSE Cabriolet (A238) 06/17→							
 Bremskraftverstärker							
AMG E53 EQ Boost 4-matic+	320	05/18→				03.7845-2506.4 300329	ATE Ø 8" pneumatisch
E 200	135	06/17→					
E 200 4-matic	135	10/17→					
E 200 EQ Boost	145	06/19→					
E 200 EQ Boost 4-matic	145	06/19→					
E 220 d	120 - 143	06/17→					
E 220 d 4-matic	143	10/17→					
E 300	180 - 190	06/17→					
E 300 d	180	05/18→					
E 300 d 4-matic	195	04/21→					
E 300 EQ Boost	190	06/19→					
E 350 d	210	11/18→					
E 350 d 4-matic	190	06/17→					
E 350 EQ Boost	220	10/17→					
E 400 4-matic	245	06/17→					
→							

	kw			 	! #		
MERCEDES-BENZ - E-KLASSE Cabriolet (A238) 06/17→							
 Bremskraftverstärker							
E 400 d 4-matic	243 - 250	08/18→				03.7845-2506.4 300329	ATE Ø 8" pneumatisch
E 450 4-matic	270	08/18→					
E 450 EQ Boost 4-matic	270	07/20→					
 Hauptbremszylinder							
AMG E53 EQ Boost 4-matic+	320	05/18→		für Linkslenker		24.4156-1221.3 011127	ATE Ø 27 ohne Bremsflüssigkeitsbehälter
E 200	135	06/17→					
E 200 4-matic	135	10/17→					
E 200 EQ Boost	145	06/19→					
E 200 EQ Boost 4-matic	145	06/19→					
E 220 d	120 - 143	06/17→					
E 220 d 4-matic	143	10/17→					
E 300	180 - 190	06/17→					
E 300 d	180	05/18→					
E 300 d 4-matic	195	04/21→					
E 300 EQ Boost	190	06/19→					
E 350 d	210	11/18→					
E 350 d 4-matic	190	06/17→					
E 350 EQ Boost	220	10/17→					
E 400 4-matic	245	06/17→					
E 400 d 4-matic	243 - 250	08/18→					
E 450 4-matic	270	08/18→					
E 450 EQ Boost 4-matic	270	07/20→					
MERCEDES-BENZ - E-KLASSE Coupe (C207) 01/09→12/16							
 Bremskraftverstärker							
E 200	135	06/13→12/16		für Linkslenker; für Fahrzeuge ohne Start-Stopp-Funktion		03.7745-6302.4 300261	ATE Ø 8" pneumatisch
E 200 CGI	135	01/10→12/16					
E 220 BlueTEC	130	05/14→12/16					
E 220 CDI / d	125	01/10→12/16		für Linkslenker; für Fahrzeuge mit Start-Stopp-Funktion		03.7745-8902.4 300297	ATE Ø 8" pneumatisch
E 220 CDI	120	02/10→12/14					
E 250	155	06/13→12/16					
E 300	185	04/11→06/16					
E 320	200	07/14→12/16					
E 350	225	04/11→12/14					
E 350 4-matic	225	02/13→12/16					
E 350 BlueTEC / d	190	05/14→12/16					
E 350 BlueTEC	185	06/13→12/16					
E 350 CDI	195	06/11→06/13					
E 400	245	06/13→12/16					
E 500	300	09/11→12/16					
E 250 CDI / BlueTEC / d	150	01/09→12/16		05/09→; für Linkslenker; für Fahrzeuge ohne Start-Stopp-Funktion		03.7745-6302.4 300261	ATE Ø 8" pneumatisch
E 250 CGI	150	01/09→12/16					
E 350 CDI	170	01/09→06/11		05/09→; für Linkslenker; für Fahrzeuge mit Start-Stopp-Funktion		03.7745-8902.4 300297	ATE Ø 8" pneumatisch
E 350 CGI	215	01/09→12/11					
E 500	285	01/09→12/16					
 Hauptbremszylinder							
E 200	135	06/13→12/16		für Linkslenker		03.2025-2521.3 010959	ATE Ø1 25,4 Ø2 20,6
E 200 CGI	135	01/10→12/16					
E 220 BlueTEC	130	05/14→12/16		für Rechtslenker		24.2025-2311.3 011023	ATE Ø1 25,4 Ø2 20,6
E 220 CDI / d	125	01/10→12/16					
E 220 CDI	120	02/10→12/14					
E 250	155	06/13→12/16					
E 300	185	04/11→06/16					
E 320	200	07/14→12/16					
E 350	225	04/11→12/14					
E 350 4-matic	225	02/13→12/16					
E 350 BlueTEC / d	190	05/14→12/16					
E 350 BlueTEC	185	06/13→12/16					
E 350 CDI	195	06/11→06/13					
E 400	245	06/13→12/16					
E 500	300	09/11→12/16					
E 250 CDI / BlueTEC / d	150	01/09→12/16		05/09→; für Linkslenker		03.2025-2521.3 010959	ATE Ø1 25,4 Ø2 20,6
E 250 CGI	150	01/09→12/16					
E 350 CDI	170	01/09→06/11		05/09→; für Rechtslenker		24.2025-2311.3 011023	ATE Ø1 25,4 Ø2 20,6
E 350 CGI	215	01/09→12/11					
E 500	285	01/09→12/16					
MERCEDES-BENZ - E-KLASSE Coupe (C238) 12/16→							
 Bremskraftverstärker							
AMG E 53 EQ Boost 4-matic+	320	05/18→				03.7845-2506.4 300329	ATE Ø 8" pneumatisch
E 200	135	12/16→					
E 200 4-matic	135	06/17→					

MERCEDES-BENZ - E-KLASSE Coupe (C238) 12/16→

Bremskraftverstärker

E 200 EQ Boost	145	06/19→					ATE Ø 8" pneumatisch
E 200 EQ Boost 4-matic	145	06/19→					
E 220 d	120 - 143	12/16→					
E 220 d 4-matic	143	03/17→					
E 300	180 - 190	12/16→					
E 300 d	180	05/18→					
E 300 d 4-matic	195	01/21→					
E 300 EQ Boost	190	06/19→					
E 350 d	210	11/18→					
E 350 d 4-matic	190	06/17→					
E 350 EQ Boost	220	10/17→					
E 400 4-matic	245	12/16→					
E 400 d 4-matic	243 - 250	08/18→					
E 450 4-matic	270	08/18→					
E 450 EQ Boost 4-matic	270	07/20→					

Hauptbremszylinder

AMG E 53 EQ Boost 4-matic+	320	05/18→	für Linkslenker				ATE Ø 27 ohne Bremsflüssigkeitsbehälter
E 200	135	12/16→					
E 200 4-matic	135	06/17→					
E 200 EQ Boost	145	06/19→					
E 200 EQ Boost 4-matic	145	06/19→					
E 220 d	120 - 143	12/16→					
E 220 d 4-matic	143	03/17→					
E 300	180 - 190	12/16→					
E 300 d	180	05/18→					
E 300 d 4-matic	195	01/21→					
E 300 EQ Boost	190	06/19→					
E 350 d	210	11/18→					
E 350 d 4-matic	190	06/17→					
E 350 EQ Boost	220	10/17→					
E 400 4-matic	245	12/16→					
E 400 d 4-matic	243 - 250	08/18→					
E 450 4-matic	270	08/18→					
E 450 EQ Boost 4-matic	270	07/20→					

MERCEDES-BENZ - E-KLASSE Pritsche/Fahrgestell (VF211) 03/03→07/09











Hauptbremszylinder

E 220 CDI	110 - 125	10/03→07/09	für Linkslenker; +SA 807/808 / 809				TRW Ø 25,4
E 270 CDI	120 - 130	03/03→07/09	für Rechtslenker; +SA 807/808 / 809				TRW Ø 25,4
E 280 CDI	140	08/05→07/09					

MERCEDES-BENZ - E-KLASSE T-Model (S210) 06/96→03/03

Hauptbremszylinder

E 200 T	100	06/96→08/00	→ A394035				Ø1 23,8 Ø2 19
			A394036→				Ø1 23,8 Ø2 19
E 200 T Kompressor	137	06/97→03/03	09/97→				Ø1 25,4 Ø2 19
E 430 T	205	06/97→03/03					
E 55 T AMG	260	08/97→03/03					
E 200 T Kompressor	120	08/00→03/03					Ø1 25,4 Ø2 19
E 270 T CDI	120 - 125	07/99→03/03					
E 280 T 4-matic	150	12/96→03/03					
E 320 T	165	12/96→03/03					
E 320 T CDI	145	07/99→03/03					
E 430 T 4-matic	205	05/99→03/03					
E 220 T CDI	100 - 105	05/99→03/03	für Linkslenker; Radstand [mm]: 2833				Ø1 23,8 Ø2 19
			für Linkslenker; Radstand [mm]: 3570				Ø1 25,4 Ø2 19
E 240 T	125	06/97→03/03	09/97→; - ESP				Ø1 23,8 Ø2 19
			09/97→; + ESP				Ø1 25,4 Ø2 19
E 240 T	125	08/00→03/03	- ESP				Ø1 23,8 Ø2 19
			+ ESP				Ø1 25,4 Ø2 19
E 280 T	150	12/96→03/03	Radstand [mm]: 3570				Ø1 25,4 Ø2 19
E 320 T 4-matic	165	12/96→03/03	06/97→				Ø1 25,4 Ø2 19

	kw			 	! #		
MERCEDES-BENZ - E-KLASSE T-Model (S211) 02/03→07/09							
 Hauptbremszylinder							
E 350 CGI E 200 CDI E 200 Kompressor E 200 T Kompressor E 220 CDI E 220 T CDI E 230 T E 240 T E 240 T 4-matic E 270 T CDI E 280 T CDI E 320 T E 320 T 4-matic E 320 T CDI E 350 T E 350 T 4-matic E 500 T E 500 T 4-matic E 55 T AMG Kompressor E 63 AMG	215 100 135 120 100 110 - 125 150 130 130 120 - 130 130 - 140 165 165 150 - 165 200 200 225 - 285 225 - 285 350	05/06→07/09 04/06→07/09 04/06→07/09 03/03→07/09 03/03→07/09 03/03→07/09 05/07→07/09 03/03→07/09 07/03→07/09 03/03→07/09 05/04→07/09 140 03/03→07/09 07/03→07/09 03/03→07/09 03/05→07/09 03/05→07/09 10/03→07/09 10/03→07/09 285 07/03→07/09 03/06→07/09		für Linkslenker		24.2125-1745.3 010998	TRW Ø 25,4
E 280 T E 280 T 4-matic E 280 T CDI 4-matic E 320 T CDI 4-matic	170 170 140 165	03/05→07/09 03/05→07/09 03/05→07/09 03/05→07/09		05/05→; für Linkslenker		24.2125-1745.3 010998	TRW Ø 25,4
MERCEDES-BENZ - E-KLASSE T-Model (S212) 08/09→12/16							
 Bremskraftverstärker							
E 200 E 250	135 155	11/12→12/16 11/12→12/16		03/13→; für Linkslenker		03.7755-8202.4 300301	ATE Ø 9 / 8" pneumatisch
E 200 CDI / BlueTEC E 200 CGI E 220 BlueTEC E 220 BlueTEC 4-matic E 220 CDI / BlueTEC E 250 CDI / BlueTEC E 250 CDI / BlueTEC 4-matic E 250 CGI E 300 E 300 4-matic E 300 CDI / BlueTEC E 350 E 350 4-matic E 350 BlueTEC E 350 BlueTEC 4-matic E 350 CDI E 350 CDI 4-matic E 350 CGI E 400 E 400 4-matic E 500 E 500 4-matic E 63 AMG E 63 AMG 4-matic	100 135 130 125 125 150 150 150 170 - 185 185 170 225 200 - 225 155 - 190 190 170 - 195 170 - 195 215 245 245 285 - 300 300 386 - 410 410	11/09→12/16 11/09→12/16 05/15→12/16 12/14→12/16 11/09→12/16 11/09→12/16 07/10→12/16 11/09→12/13 11/09→12/16 07/11→12/16 11/09→12/16 09/11→12/14 11/09→12/16 11/09→12/16 07/14→12/16 11/09→12/13 11/09→12/16 11/09→12/11 01/13→12/16 01/13→12/16 11/09→12/16 09/11→12/16 02/11→12/16 02/11→12/16		für Linkslenker		03.7755-8202.4 300301	ATE Ø 9 / 8" pneumatisch
E 220 CDI E 350 E 63 AMG	120 200 386	08/09→08/14 08/09→12/11 08/09→12/11		11/09→; für Linkslenker		03.7755-8202.4 300301	ATE Ø 9 / 8" pneumatisch
E 350 BlueTEC E 350 BlueTEC 4-matic	185 185	11/12→12/16 11/12→12/16		01/13→; für Linkslenker		03.7755-8202.4 300301	ATE Ø 9 / 8" pneumatisch
E 63 AMG E 63 AMG 4-matic	430 430	02/13→12/16 02/13→12/16		04/13→; für Linkslenker		03.7755-8202.4 300301	ATE Ø 9 / 8" pneumatisch
 Hauptbremszylinder							
E 200 E 250	135 155	11/12→12/16 11/12→12/16		03/13→; für Linkslenker		03.2126-3196.3 010968 03.4156-5106.3 010997	ATE Ø 27 ATE Ø 27
→							

















MERCEDES-BENZ - E-KLASSE T-Model (S212) 08/09→12/16

Hauptbremszylinder











E 200 E 250	135 155	11/12→12/16 11/12→12/16		03/13→; für Rechtslenker	24.2127-0901.3 011139	ATE Ø 27 ohne Bremsflüssigkeitsbehälter
E 200 CDI / BlueTEC E 200 CGI E 220 BlueTEC E 220 BlueTEC 4-matic E 220 CDI / BlueTEC E 250 CDI / BlueTEC E 250 CDI / BlueTEC 4-matic E 250 CGI E 300 E 300 4-matic E 300 CDI / BlueTEC E 350 E 350 4-matic E 350 BlueTEC E 350 BlueTEC 4-matic E 350 CDI E 350 CDI 4-matic E 350 CGI E 400 E 400 4-matic E 500 E 500 4-matic E 63 AMG E 63 AMG 4-matic	100 135 130 125 125 150 150 150 170 - 185 185 170 225 200 - 225 155 - 190 190 170 - 195 170 - 195 215 245 245 285 - 300 300 386 - 410 410	11/09→12/16 11/09→12/16 05/15→12/16 12/14→12/16 11/09→12/16 11/09→12/16 07/10→12/16 11/09→12/13 11/09→12/16 07/11→12/16 11/09→12/16 09/11→12/14 11/09→12/16 11/09→12/16 07/14→12/16 11/09→12/13 11/09→12/13 11/09→12/11 01/13→12/16 01/13→12/16 11/09→12/16 09/11→12/16 02/11→12/16 02/11→12/16		für Linkslenker für Rechtslenker	03.2126-3196.3 010968 03.4156-5106.3 010997 24.2127-0901.3 011139	ATE Ø 27 ATE Ø 27 ATE Ø 27 ohne Bremsflüssigkeitsbehälter
E 220 CDI E 350 E 63 AMG	120 200 386	08/09→08/14 08/09→12/11 08/09→12/11		11/09→; für Linkslenker 11/09→; für Rechtslenker	03.2126-3196.3 010968 03.4156-5106.3 010997 24.2127-0901.3 011139	ATE Ø 27 ATE Ø 27 ATE Ø 27 ohne Bremsflüssigkeitsbehälter
E 300 CDI	150	12/09→12/10		für Rechtslenker	24.2127-0901.3 011139	ATE Ø 27 ohne Bremsflüssigkeitsbehälter
E 350 BlueTEC E 350 BlueTEC 4-matic	185 185	11/12→12/16 11/12→12/16		01/13→; für Linkslenker 01/13→; für Rechtslenker	03.2126-3196.3 010968 03.4156-5106.3 010997 24.2127-0901.3 011139	ATE Ø 27 ATE Ø 27 ohne Bremsflüssigkeitsbehälter
E 400 4-matic	245	07/14→12/16		für Linkslenker	03.2126-3196.3 010968 03.4156-5106.3 010997	ATE Ø 27 ATE Ø 27
E 63 AMG E 63 AMG 4-matic	430 430	02/13→12/16 02/13→12/16		04/13→; für Linkslenker 04/13→; für Rechtslenker	03.2126-3196.3 010968 03.4156-5106.3 010997 24.2127-0901.3 011139	ATE Ø 27 ATE Ø 27 ohne Bremsflüssigkeitsbehälter











MERCEDES-BENZ - E-KLASSE T-Model (S213) 07/16→10/23











Hauptbremszylinder











AMG E 43 4-matic AMG E 53 EQ Boost 4-matic+	295 320	10/16→05/18 04/18→10/23		für Linkslenker	24.4156-1221.3 011127	ATE Ø 27 ohne Bremsflüssigkeitsbehälter
E 200 E 200 4-matic E 200 d E 200 EQ Boost E 200 EQ Boost 4-matic E 220 d E 220 d 4-matic E 250 E 300 d E 300 d 4-matic E 300 de E 300 de 4-matic E 300 e E 300 EQ Boost E 350 d E 350 d 4-matic E 400 4-matic E 400 d →	135 135 110 - 118 145 145 120 - 147 143 - 147 155 180 195 225 225 235 190 190 - 210 190 245 250	07/16→06/20 01/17→06/19 10/16→08/23 06/19→10/23 06/19→10/23 07/16→10/23 01/17→10/23 07/16→11/18 12/17→06/20 01/21→10/23 10/18→10/23 08/20→08/23 06/20→08/23 06/19→10/23 10/16→06/20 06/17→05/18 10/16→05/18 02/19→06/20				









	kw					! #		
MERCEDES-BENZ - E-KLASSE T-Model (S213) 07/16→10/23								
 Hauptbremszylinder								
E 400 d 4-matic	243 - 250	04/18→10/23			für Linkslenker		24.4156-1221.3 011127	ATE Ø 27 ohne Bremsflüssigkeitsbehälter
E 450 4-matic	270	08/18→06/20						
E 450 EQ Boost	270	08/20→08/23						
AMG E 63 4-matic+	420	05/17→10/23			für Linkslenker; → A; → 08/17		24.4156-1136.3 011126	ATE Ø 27 ohne Bremsflüssigkeitsbehälter
AMG E 63 S 4-matic+	450	05/17→10/23						
MERCEDES-BENZ - EQC (N293) 05/19→07/23								
 Hauptbremszylinder								
EQC 400 4-matic	300	05/19→07/23			für Linkslenker		24.4156-1221.3 011127	ATE Ø 27 ohne Bremsflüssigkeitsbehälter
MERCEDES-BENZ - G-CLASS Geländewagen geschlossen (W464) 06/22→								
 Hauptbremszylinder								
G 350 d 4-matic	183	06/22→					24.2126-1708.3 011128	Ø 27 ohne Bremsflüssigkeitsbehälter
MERCEDES-BENZ - G-CLASS Pritsche/Fahrgestell (W464) 06/22→								
 Hauptbremszylinder								
G 350 D 4-matic	183	06/22→					24.2126-1708.3 011128	Ø 27 ohne Bremsflüssigkeitsbehälter
MERCEDES-BENZ - G-KLASSE (W461) 09/89→								
 Hauptbremszylinder								
230 GE	92	06/93→07/00					03.2125-2102.3 010207	Ø 25,4
290 GD/G 290 D	70	06/93→07/00						
G 290 TD	88	07/97→07/01						
G 270 CDI	115	01/03→12/06			für Rechtslenker		03.2125-2102.3 010207	Ø 25,4
MERCEDES-BENZ - G-KLASSE (W463) 09/89→12/18								
 Hauptbremszylinder								
G 270 CDI	115	10/01→07/03			für Linkslenker; - ABS		03.2125-2102.3 010207	Ø 25,4
G 300 TD	130	08/96→07/00						
G 320	158	07/97→08/04						
G 400 CDI	184	12/00→07/06						
G 500	218	04/98→12/15						
G 55 AMG	260 - 373	04/99→12/12						
G 320 CDI	165	09/06→12/12					24.2125-1745.3 010998	TRW Ø 25,4
G 350 CDI	155	07/11→08/15						
G 500	285	05/08→08/15			→ 12/11		24.2125-1745.3 010998	TRW Ø 25,4
MERCEDES-BENZ - G-KLASSE Cabrio (W463) 09/89→02/18								
 Hauptbremszylinder								
G 300 TD	130	09/96→07/00			für Linkslenker; - ABS		03.2125-2102.3 010207	Ø 25,4
G 320	158	11/97→08/04						
G 400 CDI	184	12/00→07/06						
G 500	218 - 285	04/98→12/15						
G 320 CDI	165	09/06→12/12					24.2125-1745.3 010998	TRW Ø 25,4
G 350 CDI	155	07/11→12/15						
MERCEDES-BENZ - G-KLASSE Pritsche/Fahrgestell (W461) 09/89→								
 Hauptbremszylinder								
G 280 Cdi 4-matic	135	05/07→12/12			144791→; + ABS; für erhöhte Nutzlast		24.2125-1728.3 010751	Ø 25,4
MERCEDES-BENZ - GLA-KLASSE (X156) 12/13→05/22								
 Hauptbremszylinder								
AMG GLA 45 4-matic	280	07/15→06/19			für Linkslenker		24.4123-1718.3 011016	TRW Ø 23,8 ohne Bremsflüssigkeitsbehälter
GLA 180	90	02/15→12/19						
GLA 180 CDI / d	80	07/14→05/18						
GLA 200	110 - 115	12/13→12/19						
GLA 200 CDI / d	100	12/13→12/19						
GLA 200 CDI 4-matic	100	12/13→05/19						
GLA 220 4-matic	135	01/17→12/19						
GLA 220 CDI / d	120	12/13→05/19						
GLA 220 CDI / d 4-matic	120	12/13→12/19						
GLA 220 CDI	125	12/13→05/19						
GLA 220 CDI 4-matic	125	12/13→12/19						
GLA 220 d	130	07/15→05/19						
→								











	kW					! #		
MERCEDES-BENZ - GLA-KLASSE (X156) 12/13→05/22								
 Hauptbremszylinder								
GLA 220 d 4-matic GLA 250 GLA 250 4-matic GLA 250 Flex GLA 45 AMG 4-matic	130 155 155 155 265	07/15→12/19 12/13→12/19 12/13→12/19 01/15→12/19 05/14→06/19		für Linkslenker		24.4123-1718.3	011016	TRW Ø 23,8 ohne Bremsflüssigkeitsbehälter
MERCEDES-BENZ - GLC (X253) 06/15→06/22								
 Hauptbremszylinder								
200 d 200 d 4-matic 200 EQ Boost 200 EQ Boost 4-matic 220 d 220 d 4-matic 300 d 4-matic 300 de 4-matic 300 EQ Boost 4-matic 400 d 4-matic AMG 43 4-matic F-CELL	120 120 145 145 143 143 180 225 190 243 287 155	04/19→06/22 04/19→06/22 04/19→06/22 04/19→06/22 04/19→06/22 04/19→06/22 04/19→06/22 05/20→06/22 04/19→06/22 08/19→06/22 08/19→06/22 10/18→04/20		für Linkslenker		24.4156-1221.3	011127	ATE Ø 27 ohne Bremsflüssigkeitsbehälter
220 d 4-matic 250 4-matic 250 CNG 4-matic 250 d 4-matic 250 Flexfuel 4-matic 300 4-matic 350 d 4-matic 350 e 4-matic AMG 43 4-matic	120 - 125 155 155 150 155 180 - 190 190 235 270	06/15→04/19 06/15→04/19 06/15→04/19 06/15→04/19 06/15→04/19 07/15→05/19 10/16→04/19 01/16→04/19 04/16→08/19		für Linkslenker		24.4156-1136.3	011126	ATE Ø 27 ohne Bremsflüssigkeitsbehälter
300	180	01/16→04/19		für Linkslenker; +SA 806/807 / 808/809		24.4156-1136.3	011126	ATE Ø 27 ohne Bremsflüssigkeitsbehälter
				für Linkslenker		24.4156-1221.3	011127	ATE Ø 27 ohne Bremsflüssigkeitsbehälter
300 e 4-matic	235	11/19→06/22		für Linkslenker; → Modelljahr bis: 2019		24.4156-1136.3	011126	ATE Ø 27 ohne Bremsflüssigkeitsbehälter
				für Linkslenker		24.4156-1221.3	011127	ATE Ø 27 ohne Bremsflüssigkeitsbehälter
AMG 63 4-matic+ AMG 63 S 4-matic+	350 375	06/17→06/22 06/17→06/22		für Linkslenker; +SA 806/807		24.4156-1136.3	011126	ATE Ø 27 ohne Bremsflüssigkeitsbehälter
MERCEDES-BENZ - GLC Coupe (C253) 06/16→03/23								
 Hauptbremszylinder								
200 4-matic 300 4-matic	145 190	01/17→05/19 11/16→05/19		für Linkslenker		24.4156-1136.3	011126	ATE Ø 27 ohne Bremsflüssigkeitsbehälter
200 d 200 d 4-matic 200 EQ Boost 200 EQ Boost 4-matic 220 d 4-matic 260 4-matic 300 4-matic 300 d 4-matic 300 de 4-matic 300 EQ Boost 4-matic 400 d 4-matic AMG 43 4-matic	120 120 145 145 143 145 190 180 225 190 243 287	04/19→08/21 04/19→03/23 04/19→03/23 04/19→03/23 04/19→03/23 11/19→03/23 11/19→03/23 04/19→03/23 05/20→03/23 04/19→03/23 08/19→03/23 08/19→03/23		für Linkslenker		24.4156-1221.3	011127	ATE Ø 27 ohne Bremsflüssigkeitsbehälter
220 d 4-matic 250 4-matic 250 d 4-matic 300 4-matic 350 d 4-matic 350 e 4-matic AMG 43 4-matic	120 - 125 155 150 180 190 235 270	06/16→04/19 06/16→04/19 06/16→04/19 10/16→04/19 10/16→04/19 10/16→04/19 10/16→04/19 10/16→08/19				24.4156-1136.3	011126	ATE Ø 27 ohne Bremsflüssigkeitsbehälter
300 e 4-matic	235	11/19→03/23		für Linkslenker; → Modelljahr bis: 2019		24.4156-1136.3	011126	ATE Ø 27 ohne Bremsflüssigkeitsbehälter
				für Linkslenker		24.4156-1221.3	011127	ATE Ø 27 ohne Bremsflüssigkeitsbehälter
AMG 63 4-matic+ AMG 63 S 4-matic+	350 375	06/17→03/23 06/17→03/23		für Linkslenker; +SA 806/807		24.4156-1136.3	011126	ATE Ø 27 ohne Bremsflüssigkeitsbehälter













	kW					! #		
MERCEDES-BENZ - GLK-KLASSE (X204) 06/08→12/15								
 Bremskraftverstärker								
200 200 CDI	135 100 - 105	08/13→06/15 07/10→06/15		für Linkslenker; für Fahrzeuge ohne Start-Stopp-Funktion		03.7745-6302.4	300261	ATE Ø 8" pneumatisch
250 250 4-matic 250 CDI 4-matic 300 4-matic	155 155 150 170 - 185	08/13→06/15 08/13→06/15 09/09→06/15 07/09→12/15		für Linkslenker; für Fahrzeuge mit Start-Stopp-Funktion		03.7745-8902.4	300297	ATE Ø 8" pneumatisch
350 350 CDI 4-matic	200 165 - 195	04/09→06/15 07/09→06/15						
220 CDI 220 CDI 4-matic	120 - 125 120 - 125	12/08→06/15 12/08→06/15		04/09→; für Linkslenker; für Fahrzeuge ohne Start-Stopp-Funktion		03.7745-6302.4	300261	ATE Ø 8" pneumatisch
				04/09→; für Linkslenker; für Fahrzeuge mit Start-Stopp-Funktion		03.7745-8902.4	300297	ATE Ø 8" pneumatisch
280 4-matic 320 CDI 4-matic 350 4-matic	170 165 200 - 225	06/08→06/09 06/08→06/15 06/08→06/15		09/08→; für Linkslenker; für Fahrzeuge ohne Start-Stopp-Funktion		03.7745-6302.4	300261	ATE Ø 8" pneumatisch
				09/08→; für Linkslenker; für Fahrzeuge mit Start-Stopp-Funktion		03.7745-8902.4	300297	ATE Ø 8" pneumatisch
 Hauptbremszylinder								
200 200 CDI	135 100 - 105	08/13→06/15 07/10→06/15		für Linkslenker		03.2025-2521.3	010959	ATE Ø1 25,4 Ø2 20,6
250 250 4-matic 250 CDI 4-matic 300 4-matic	155 155 150 170 - 185	08/13→06/15 08/13→06/15 09/09→06/15 07/09→12/15						
350 350 CDI 4-matic	200 165 - 195	04/09→06/15 07/09→06/15						
220 CDI 220 CDI 4-matic	120 - 125 120 - 125	12/08→06/15 12/08→06/15		04/09→; für Linkslenker		03.2025-2521.3	010959	ATE Ø1 25,4 Ø2 20,6
280 4-matic 320 CDI 4-matic 350 4-matic	170 165 200 - 225	06/08→06/09 06/08→06/15 06/08→06/15		09/08→; für Linkslenker		03.2025-2521.3	010959	ATE Ø1 25,4 Ø2 20,6
MERCEDES-BENZ - GL-KLASSE (X164) 09/06→12/12								
Pedalwegsensoren, Bremspedal								
GL 320 CDI / 350 BlueTEC 4-matic GL 350 CDI 4-matic	155 165 - 195	12/09→08/12 05/09→08/12		→ 06/12		03.0655-0007.2	370007	ATE
GL 450 4-matic GL 450 CDI 4-matic GL 500 4-matic	250 225 285	09/06→08/12 05/09→08/12 09/06→12/12						
GL 320 CDI 4-matic GL 420 CDI 4-matic	160 - 165 225	09/06→12/09 09/06→05/09				03.0655-0007.2	370007	ATE
 Hauptbremszylinder								
GL 320 CDI / 350 BlueTEC 4-matic GL 350 CDI 4-matic	155 165 - 195	12/09→08/12 05/09→08/12		→ 06/12		03.4156-0014.3	010930	ATE Ø 27 ohne Bremsflüssigkeitsbehälter
GL 450 4-matic GL 450 CDI 4-matic GL 500 4-matic	250 225 285	09/06→08/12 05/09→08/12 09/06→12/12						
GL 320 CDI 4-matic GL 420 CDI 4-matic	160 - 165 225	09/06→12/09 09/06→05/09				03.4156-0014.3	010930	ATE Ø 27 ohne Bremsflüssigkeitsbehälter
MERCEDES-BENZ - M-KLASSE (W163) 02/98→07/05								
Pedalwegsensoren, Bremspedal								
ML 270 CDI ML 350 ML 400 CDI ML 500 ML 55 AMG	120 173 184 215 255	12/99→06/05 02/03→06/05 09/01→06/05 09/01→06/05 02/00→06/05				03.0655-0007.2	370007	ATE
ML 320 ML 350	160 180	02/98→08/02 08/02→06/05		03/98→; + ESP 09/02→		03.0655-0007.2	370007	ATE
ML 430 →	200	02/98→06/05		09/98→		03.0655-0007.2	370007	ATE













	kw			 	! #		
MERCEDES-BENZ - M-KLASSE (W163) 02/98→07/05							
 Hauptbremszylinder							
ML 230 ML 320	110 160	02/98→06/05 02/98→08/02		03/98→		03.2125-7310.3 010743	ATE Ø 25,4
ML 270 CDI ML 350 ML 400 CDI ML 500 ML 55 AMG	120 173 184 215 255	12/99→06/05 02/03→06/05 09/01→06/05 09/01→06/05 02/00→06/05				03.2125-7310.3 010743	ATE Ø 25,4
ML 350 ML 430	180 200	08/02→06/05 02/98→06/05		09/02→ 09/98→		03.2125-7310.3 010743	ATE Ø 25,4 ATE Ø 25,4
MERCEDES-BENZ - M-KLASSE (W164) 02/05→12/12							
Pedalwegsensoren, Bremspedal							
ML 280 CDI 4-matic ML 320 CDI 4-matic	140 155 - 165	07/05→07/09 07/05→07/11				03.0655-0007.2 370007	ATE
ML 350 CDI 4-matic ML 63 AMG 4-matic	157 375	09/09→12/10 09/06→12/11					
ML 300 4-matic ML 300 CDI 4-matic	170 140 - 150	03/10→12/11 07/09→12/11		→ 05/11		03.0655-0007.2 370007	ATE
ML 350 4-matic ML 350 CDI 4-matic	200 155 - 170	02/05→12/11 07/09→12/11					
ML 450 CDI 4-matic ML 500 4-matic	225 225 - 285	09/09→12/11 07/05→12/11					
ML 63 AMG 4-matic ML 420 CDI 4-matic	375 225	01/06→12/11 02/06→09/09		04/06→		03.0655-0007.2 370007	ATE
 Hauptbremszylinder							
ML 280 CDI 4-matic ML 320 CDI 4-matic	140 155 - 165	07/05→07/09 07/05→07/11				03.4156-0014.3 010930	ATE Ø 27 ohne Bremsflüssigkeitsbehälter
ML 350 CDI 4-matic ML 63 AMG 4-matic	157 375	09/09→12/10 09/06→12/11					
ML 300 4-matic ML 300 CDI 4-matic	170 140 - 150	03/10→12/11 07/09→12/11		→ 05/11		03.4156-0014.3 010930	ATE Ø 27 ohne Bremsflüssigkeitsbehälter
ML 350 4-matic ML 350 CDI 4-matic	200 155 - 170	02/05→12/11 07/09→12/11					
ML 450 CDI 4-matic ML 500 4-matic	225 225 - 285	09/09→12/11 07/05→12/11					
ML 63 AMG 4-matic ML 420 CDI 4-matic	375 225	01/06→12/11 02/06→09/09		04/06→		03.4156-0014.3 010930	ATE Ø 27 ohne Bremsflüssigkeitsbehälter
MERCEDES-BENZ - R-KLASSE (W251, V251) 08/05→10/17							
Pedalwegsensoren, Bremspedal							
R 280 R 280 CDI R 280 CDI 4-matic R 300 R 300 CDI R 300 CDI 4-matic R 320 CDI 4-matic	170 140 140 170 140 140 155 - 165	01/07→12/14 05/06→12/12 05/06→12/12 07/09→12/14 07/09→12/12 07/09→12/12 01/06→12/12				03.0655-0007.2 370007	ATE
R 350 R 350 4-matic R 350 CDI 4-matic	200 200 165 - 195	01/07→12/12 08/05→12/12 07/09→12/14					
R 350 CGI 4-matic R 500 4-matic	225 225 - 285	10/11→12/14 08/05→12/14					
R 63 AMG 4-matic R 350 CDI 4-matic	375 155	02/06→12/10 01/06→12/14		05/09→		03.0655-0007.2 370007	ATE
 Hauptbremszylinder							
R 280 R 280 CDI R 280 CDI 4-matic R 300 R 300 CDI R 300 CDI 4-matic R 320 CDI 4-matic	170 140 140 170 140 140 155 - 165	01/07→12/14 05/06→12/12 05/06→12/12 07/09→12/14 07/09→12/12 07/09→12/12 01/06→12/12				03.4156-0014.3 010930	ATE Ø 27 ohne Bremsflüssigkeitsbehälter
R 350 →	200	01/07→12/12					













	kw			 	! #		
MERCEDES-BENZ - R-KLASSE (W251, V251) 08/05→10/17							
 Hauptbremszylinder							
R 350 4-matic R 350 CDI 4-matic	200 165 - 195	08/05→12/12 07/09→12/14				03.4156-0014.3 010930	ATE Ø 27 ohne Bremsflüssigkeitsbehälter
R 350 CGI 4-matic R 500 4-matic	225 225 - 285	10/11→12/14 08/05→12/14					
R 63 AMG 4-matic R 350 CDI 4-matic	375 155	02/06→12/10 01/06→12/14		05/09→		03.4156-0014.3 010930	ATE Ø 27 ohne Bremsflüssigkeitsbehälter
MERCEDES-BENZ - S-KLASSE (W220, V220) 09/98→08/05							
 Hauptbremszylinder							
S 280 S 320 S 430 S 430 L S 500 L S 500	150 165 205 205 225 220 - 225	10/98→08/05 10/98→08/05 10/98→08/05 10/98→08/05 10/98→08/05 10/98→08/05		11/98→		24.4025-1701.3 010719	Ø 25,4
S 320 CDI S 350 S 350 L S 350 4-matic S 400 CDI S 430 4-matic S 500 4-matic S 55 AMG S 55 AMG Kompressor S 600 S 600 L S 63 AMG S 65 AMG L S 65 AMG S 400 CDI	145 - 150 180 180 180 191 205 225 265 368 270 - 368 270 - 368 326 450 450 184	08/99→08/05 09/02→08/05 09/02→08/05 06/03→08/05 06/03→08/05 09/02→08/05 09/02→08/05 04/99→08/05 06/02→08/05 01/00→08/05 01/00→08/05 09/01→08/05 03/04→08/05 03/04→08/05 06/00→08/05				24.4025-1701.3 010719	Ø 25,4
				08/00→		24.4025-1701.3 010719	Ø 25,4
MERCEDES-BENZ - S-KLASSE (W221, V221) 09/05→12/13							
 Bremskraftverstärker							
S 280 S 300 S 320 CDI S 320 CDI 4-matic S 350 4-matic S 350 CDI S 350 CDI 4-matic S 420 CDI S 450 CDI S 63 AMG	170 170 173 155 - 173 200 155 - 173 155 - 173 235 235 400 - 420	08/06→12/13 08/06→12/13 12/05→06/09 10/05→12/13 02/08→12/13 06/09→12/13 01/09→07/13 10/06→12/09 01/09→12/13 03/11→12/13		→ A 265574		03.7858-1932.4 300263	ATE Ø 9 / 8" pneumatisch
S 320 CDI S 350 S 500	155 200 285	10/05→12/13 10/05→12/13 10/05→12/13		12/05→; → A 265574		03.7858-1932.4 300263	ATE Ø 9 / 8" pneumatisch
S 450 S 450 L S 450 4-matic S 500 4-matic	250 250 250 285	12/05→12/13 12/05→12/13 12/05→12/13 10/05→12/13		04/06→; → A 265574		03.7858-1932.4 300263	ATE Ø 9 / 8" pneumatisch
S 63 AMG	386	10/06→12/13		01/07→; → A 265574		03.7858-1932.4 300263	ATE Ø 9 / 8" pneumatisch
Pedalwegsensor, Bremspedal							
S 250 CDI S 350 BlueTec S 350 BlueTEC 4-matic S 350 CGI S 350 CGI 4-matic S 500 CGI S 500 CGI 4-matic S 550	150 190 190 225 225 320 320 320	01/11→12/13 04/11→12/13 04/11→12/13 04/11→12/13 04/11→12/13 04/11→12/13 03/11→12/13 09/11→12/13		→ 05/13; für Fahrzeuge mit autom. Distanzregelung		03.0655-0007.2 370007	ATE
S 280 S 300 S 320 CDI 4-matic S 350 4-matic S 350 CDI	170 170 173 200 155 - 173	08/06→12/13 08/06→12/13 10/06→12/13 02/08→12/13 06/09→12/13		→ A 265574		03.0655-0007.2 370007	ATE
S 320 CDI	155	10/05→12/13		12/05→; → A 265574		03.0655-0007.2 370007	ATE
→							













	kw			 	! #		
MERCEDES-BENZ - S-KLASSE (W221, V221) 09/05→12/13							
Pedalwegsensor, Bremspedal							
S 350 S 500	200 285	10/05→12/13 10/05→12/13		A 265575→; → 05/13; für Fahrzeuge mit autom. Distanzregelung		03.0655-0007.2 370007	ATE
S 320 CDI S 320 CDI 4-matic S 350 CDI 4-matic	173 155 155 - 173	12/05→06/09 10/05→12/13 01/09→07/13		→ A 265574		03.0655-0007.2 370007	ATE
S 420 CDI S 450 CDI	235 235	10/06→12/09 01/09→12/13		A 265575→; → 05/13; für Fahrzeuge mit autom. Distanzregelung		03.0655-0007.2 370007	ATE
S 400 Hybrid	220	09/09→12/13				03.0655-0007.2 370007	ATE
S 400 Hybrid	205	01/09→12/13		06/09→ 05/13		03.0655-0007.2 370007	ATE
S 450 S 450 L S 450 4-matic S 500 4-matic	250 250 250 285	12/05→12/13 12/05→12/13 12/05→12/13 10/05→12/13		04/06→; → A 265574		03.0655-0007.2 370007	ATE
S 600	380	12/05→12/13		A 265575→; → 05/13; für Fahrzeuge mit autom. Distanzregelung		03.0655-0007.2 370007	ATE
				für Fahrzeuge ohne Start-Stopp-Funktion; → 05/13		03.0655-0007.2 370007	ATE
				A 060621→; für Fahrzeuge ohne Start-Stopp-Funktion; → 05/13		03.0655-0007.2 370007	ATE
				→ A 060620; für Fahrzeuge ohne Start-Stopp-Funktion		03.0655-0007.2 370007	ATE
S 63 AMG	400 - 420	03/11→12/13		→ A 265574		03.0655-0007.2 370007	ATE
				A 265575→; → 05/13; für Fahrzeuge mit autom. Distanzregelung		03.0655-0007.2 370007	ATE
				→ 05/13		03.0655-0007.2 370007	ATE
S 63 AMG	386	10/06→12/13		01/07→; → A 265574		03.0655-0007.2 370007	ATE
				A 265575→; → 05/13; für Fahrzeuge mit autom. Distanzregelung		03.0655-0007.2 370007	ATE
				01/07→ 05/13		03.0655-0007.2 370007	ATE
S 65 AMG	450	12/05→12/13		A 060621→; → 05/13		03.0655-0007.2 370007	ATE
				04/06→; → A 060620		03.0655-0007.2 370007	ATE
				04/06→ 05/13		03.0655-0007.2 370007	ATE
S 65 AMG	463	10/10→12/13		→ A 060620		03.0655-0007.2 370007	ATE
				A 060621→; → 05/13		03.0655-0007.2 370007	ATE
				→ 05/13		03.0655-0007.2 370007	ATE
 Hauptbremszylinder							
S 250 CDI S 350 BlueTec S 350 BlueTEC 4-matic S 350 CGI S 350 CGI 4-matic S 500 CGI S 500 CGI 4-matic S 550	150 190 190 225 225 320 320 320	01/11→12/13 04/11→12/13 04/11→12/13 04/11→12/13 04/11→12/13 04/11→12/13 03/11→12/13 09/11→12/13		→ 05/13		03.4156-0073.3 010942	ATE Ø 27
S 280 S 300 S 320 CDI 4-matic S 350 4-matic S 350 CDI	170 170 173 200 155 - 173	08/06→12/13 08/06→12/13 10/06→12/13 02/08→12/13 06/09→12/13		→ A 293047; nicht für gepanzerte Fahrzeuge		03.4055-0013.3 010793	ATE Ø 25,4
S 600 S 63 AMG S 65 AMG	380 400 - 420 463	12/05→12/13 03/11→12/13 10/10→12/13		A 293048→; → 05/13; nicht für gepanzerte Fahrzeuge		03.4156-0073.3 010942	ATE Ø 27
S 320 CDI S 350 S 500	155 200 285	10/05→12/13 10/05→12/13 10/05→12/13		12/05→; → A 293047; nicht für gepanzerte Fahrzeuge		03.4055-0013.3 010793	ATE Ø 25,4
				A 293048→; → 05/13; nicht für gepanzerte Fahrzeuge		03.4156-0073.3 010942	ATE Ø 27
S 320 CDI S 320 CDI 4-matic S 350 CDI 4-matic	173 155 155 - 173	12/05→06/09 10/05→12/13 01/09→07/13		→ A 293047; nicht für gepanzerte Fahrzeuge		03.4055-0013.3 010793	ATE Ø 25,4
				A 293048→; nicht für gepanzerte Fahrzeuge		03.4156-0073.3 010942	ATE Ø 27
S 420 CDI S 450 CDI	235 235	10/06→12/09 01/09→12/13				03.4155-5141.3 010969	ATE Ø 25,4
S 400 Hybrid	220	09/09→12/13				03.4155-5141.3 010969	ATE Ø 25,4
S 400 Hybrid	205	01/09→12/13		06/09→ 05/13		03.4155-5141.3 010969	ATE Ø 25,4
S 450 S 450 L S 450 4-matic S 500 4-matic S 65 AMG	250 250 250 285 450	12/05→12/13 12/05→12/13 12/05→12/13 10/05→12/13 12/05→12/13		04/06→; → A 293047; nicht für gepanzerte Fahrzeuge		03.4055-0013.3 010793	ATE Ø 25,4
				A 293048→; → 05/13; nicht für gepanzerte Fahrzeuge		03.4156-0073.3 010942	ATE Ø 27
S 63 AMG	386	10/06→12/13		01/07→; → A 293047; nicht für gepanzerte Fahrzeuge		03.4055-0013.3 010793	ATE Ø 25,4
				A 293048→; → 05/13; nicht für gepanzerte Fahrzeuge		03.4156-0073.3 010942	ATE Ø 27















	kw				! #		
MERCEDES-BENZ - S-KLASSE Coupe (C215) 03/99→12/06							
 Hauptbremszylinder							
CL 500	225	03/99→03/06				24.4025-1701.3 010719	Ø 25,4
CL 55 AMG	265	10/99→03/06					
CL 55 AMG Kompressor	368	06/02→03/06					
CL 600	270	03/99→03/06					
	368						
CL 65 AMG	450	09/03→03/06					
MERCEDES-BENZ - S-KLASSE Coupe (C216) 05/06→12/13							
 Bremskraftverstärker							
CL 500	285	06/06→12/13		07/06→; → A 024306		03.7858-1932.4 300263	ATE Ø 9 / 8" pneumatisch
CL 600	380	05/06→12/13					
CL 500	320	02/11→12/13		→ A 024306		03.7858-1932.4 300263	ATE Ø 9 / 8" pneumatisch
CL 500 4-matic	320	02/11→12/13					
CL 63 AMG	386 -	09/07→12/13					
	420						
CL 65 AMG	463	02/11→12/13					
CL 500 4-matic	285	02/08→12/13		03/08→; → A 024306		03.7858-1932.4 300263	ATE Ø 9 / 8" pneumatisch
CL 63 AMG	386	10/06→12/13		01/07→; → A 024306		03.7858-1932.4 300263	ATE Ø 9 / 8" pneumatisch
CL 65 AMG	450	10/06→12/10					
Pedalwegsensor, Bremspedal							
CL 500	285	06/06→12/13		A 024307→		03.0655-0007.2 370007	ATE
CL 600	380	05/06→12/13		07/06→; → A 024306		03.0655-0007.2 370007	ATE
CL 500	320	02/11→12/13		A 024307→		03.0655-0007.2 370007	ATE
CL 500 4-matic	320	02/11→12/13		→ A 024306		03.0655-0007.2 370007	ATE
CL 63 AMG	386 -	09/07→12/13					
	420						
CL 65 AMG	463	02/11→12/13					
CL 500 4-matic	285	02/08→12/13		A 024307→		03.0655-0007.2 370007	ATE
				03/08→; → A 024306		03.0655-0007.2 370007	ATE
CL 63 AMG	386	10/06→12/13		A 024307→		03.0655-0007.2 370007	ATE
CL 65 AMG	450	10/06→12/10		01/07→; → A 024306		03.0655-0007.2 370007	ATE
Hauptbremszylinder							
CL 500	285	06/06→12/13		07/06→; → A 024016		03.4055-0013.3 010793	ATE Ø 25,4
CL 600	380	05/06→12/13		A 024017→		03.4156-0073.3 010942	ATE Ø 27
CL 500	320	02/11→12/13				03.4156-0073.3 010942	ATE Ø 27
CL 500 4-matic	320	02/11→12/13					
CL 63 AMG	400 -	01/10→12/13					
	420						
CL 500 4-matic	285	02/08→12/13		03/08→; → A 024016		03.4055-0013.3 010793	ATE Ø 25,4
				A 024017→		03.4156-0073.3 010942	ATE Ø 27
CL 63 AMG	386	10/06→12/13		01/07→; → A 024016		03.4055-0013.3 010793	ATE Ø 25,4
CL 65 AMG	450	10/06→12/10		A 024017→		03.4156-0073.3 010942	ATE Ø 27
CL 63 AMG	386	09/07→12/11		→ A 024016		03.4055-0013.3 010793	ATE Ø 25,4
CL 65 AMG	463	02/11→12/13		A 024017→		03.4156-0073.3 010942	ATE Ø 27
MERCEDES-BENZ - SL (R129) 03/89→09/04							
 Hauptbremszylinder							
280	142	08/93→10/01		→ F102744; für Linkslenker		03.2025-0211.3 010034	Ø1 25,4 Ø2 19
320	170	09/93→10/01		F102745→ F148143; für Linkslenker		24.2025-1702.3 010515	Ø1 25,4 Ø2 19
500	235	09/92→10/01		08/93→; → F102744; - ESP; für Linkslenker		03.2025-0211.3 010034	Ø1 25,4 Ø2 19
				F102745→ F148143; - ESP; für Linkslenker		24.2025-1702.3 010515	Ø1 25,4 Ø2 19
60 AMG	280	05/97→10/01		→ F102744; - ESP; für Linkslenker		03.2025-0211.3 010034	Ø1 25,4 Ø2 19
				F102745→ F148143; - ESP; für Linkslenker		24.2025-1702.3 010515	Ø1 25,4 Ø2 19
MERCEDES-BENZ - SL (R230) 10/01→01/12							
 Bremskraftverstärker							
65 AMG Black Series	493	07/08→01/12		→ 11/11; für Linkslenker		03.7848-2002.4 300166	ATE Ø 7 / 8" pneumatisch
Pedalwegsensor, Bremspedal							
65 AMG Black Series	493	07/08→01/12		→ 11/11; für Linkslenker		03.0655-0007.2 370007	ATE
MERCEDES-BENZ - SL (R231) 12/11→04/20							
 Hauptbremszylinder							
350	225	02/12→04/14		03/12→		03.2126-3196.3 010968	ATE Ø 27
→							













	kw					! #		
MERCEDES-BENZ - SL (R231) 12/11→04/20								
 Hauptbremszylinder								
500 63 AMG	320 395 - 415	01/12→04/20 01/12→05/19		03/12→			03.2126-3196.3 010968	ATE Ø 27
400 500 63 AMG 65 AMG	245 - 270 335 420 - 430 463	04/14→04/20 04/15→04/20 04/14→05/19 05/12→06/18					03.2126-3196.3 010968	ATE Ø 27
MERCEDES-BENZ - SLC (R172) 01/16→								
 Bremskraftverstärker								
180 200 250 d 300 AMG SLC 43	115 135 150 180 270 - 287	01/16→ 01/16→ 01/16→10/17 01/16→ 01/16→		für Linkslenker; für Fahrzeuge ohne Start-Stopp-Funktion			03.7745-1632.4 300293	ATE Ø 8 / 7" pneumatisch
				für Linkslenker; für Fahrzeuge mit Start-Stopp-Funktion			03.7745-1832.4 300294	ATE Ø 8 / 7" pneumatisch
MERCEDES-BENZ - SLK (R170) 04/96→04/04								
Pedalwegsensor, Bremspedal								
200 Kompressor 230 Kompressor 32 AMG Kompressor 320	120 145 260 160	03/00→04/04 03/00→04/04 03/01→04/04 03/00→04/04		→ 03/04 04/00→ 03/04			03.0655-0007.2 370007	ATE
 Hauptbremszylinder								
200 200 Kompressor 230 Kompressor	100 141 142	09/96→03/00 10/96→03/00 09/96→03/00		→ F025730 F025731→			24.2023-1701.3 010514 24.2023-1702.3 010534	TRW Ø1 23,8 Ø2 19
200 Kompressor 230 Kompressor 32 AMG Kompressor 320	120 145 260 160	03/00→04/04 03/00→04/04 03/01→04/04 03/00→04/04		→ 03/04; für Rechtslenker 04/00→ 03/04; für Rechtslenker			03.2025-1741.3 010705 03.2025-1741.3 010705	ATE Ø1 25,4 Ø2 20,6
MERCEDES-BENZ - SLK (R171) 03/04→12/11								
Pedalwegsensor, Bremspedal								
200 Kompressor 300 350 55 AMG 280	120 - 135 170 200 - 224 265 - 294 170	03/04→02/11 04/09→02/11 06/04→02/11 06/04→02/11 01/05→02/11		→ F 196638 F 196639→; → 01/11 F 196639→; → 01/11 04/05→; → F 196638			03.0655-0007.2 370007 03.0655-0007.2 370007 03.0655-0007.2 370007 03.0655-0007.2 370007	ATE ATE ATE ATE
 Hauptbremszylinder								
200 Kompressor 300 350 55 AMG 280	120 - 135 170 200 - 224 265 - 294 170	03/04→02/11 04/09→02/11 06/04→02/11 06/04→02/11 01/05→02/11		→ 01/11; für Linkslenker 04/05→ 01/11; für Linkslenker			03.2025-1741.3 010705 03.2025-1741.3 010705	ATE Ø1 25,4 Ø2 20,6 ATE Ø1 25,4 Ø2 20,6
MERCEDES-BENZ - SLK (R172) 01/11→								
 Bremskraftverstärker								
200 250 250 CDI / d 300 350 55 AMG	135 150 150 180 225 310	02/11→ 02/11→ 01/12→ 07/15→ 02/11→ 01/12→		für Linkslenker; für Fahrzeuge ohne Start-Stopp-Funktion für Linkslenker; für Fahrzeuge mit Start-Stopp-Funktion			03.7745-1632.4 300293 03.7745-1832.4 300294	ATE Ø 8 / 7" pneumatisch ATE Ø 8 / 7" pneumatisch
MERCEDES-BENZ - SPRINTER 2-t Bus (B901, B902) 01/95→05/06								
 Hauptbremszylinder								
208 CDI 208 D 210 D 211 CDI 212 D 213 CDI 214 →	60 58 75 80 90 95 105	04/00→05/06 02/95→04/00 03/97→04/00 04/00→05/06 02/95→04/00 04/00→05/06 02/95→05/06		→ A906425 A906426→			24.2123-1711.3 010518 24.2123-1754.3 010741	Ø 23,8 Ø 23,8

	kw					! #		
MERCEDES-BENZ - SPRINTER 2-t Bus (B901, B902) 01/95→05/06								
 Hauptbremszylinder								
214 NGT 216 CDI	95 115	02/95→05/06 04/00→05/06		→ A906425			24.2123-1711.3 010518	Ø 23,8
				A906426→			24.2123-1754.3 010741	Ø 23,8
MERCEDES-BENZ - SPRINTER 2-t Kasten (B901, B902) 01/95→05/06								
 Hauptbremszylinder								
208 CDI 208 D	60 58 - 60	04/00→05/06 02/95→04/00		→ A906425			24.2123-1711.3 010518	Ø 23,8
				A906426→			24.2123-1754.3 010741	Ø 23,8
210 D 211 CDI 212 D 213 CDI 214 214 NGT 216 CDI	75 80 90 95 105 95 115	01/97→04/00 04/00→05/06 02/95→04/00 04/00→05/06 02/95→05/06 02/95→05/06 04/00→05/06						
MERCEDES-BENZ - SPRINTER 2-t Pritsche/Fahrgestell (B901, B902) 01/95→05/06								
 Hauptbremszylinder								
208 CDI 208 D 210 D 211 CDI 212 D 213 CDI 214 214 NGT 216 CDI	60 60 75 80 90 95 105 95 115	04/00→05/06 09/96→04/00 01/97→04/00 04/00→05/06 02/95→04/00 04/00→05/06 02/95→05/06 02/95→05/06 04/00→05/06		→ A906425			24.2123-1711.3 010518	Ø 23,8
				A906426→			24.2123-1754.3 010741	Ø 23,8
208 D	58	01/95→04/00		02/95→; → A906425			24.2123-1711.3 010518	Ø 23,8
				A906426→			24.2123-1754.3 010741	Ø 23,8
MERCEDES-BENZ - SPRINTER 3,5-t Bus (B906) 06/06→09/20								
 Hauptbremszylinder								
309 CDI 311 CDI 313 CDI 313 CDI 4x4 314 CDI 314 CDI 4x4 315 CDI 316 CDI 316 CDI 4x4	65 84 95 95 105 105 110 120 120	04/12→12/19 05/16→12/18 08/11→12/16 08/11→12/16 05/16→12/18 05/16→12/18 06/13→09/20 08/11→12/18 08/11→12/18					24.2126-1704.3 010990 24.2126-1708.3 011128	TRW Ø 27 Ø 27 ohne Bremsflüssigkeitsbehälter
310 CDI 311 CDI 311 CDI 4x4 315 CDI 315 CDI 4x4 316 316 LGT 316 NGT 318 CDI 318 CDI 4x4 319 CDI / BlueTEC 319 CDI / BlueTEC 4x4 324	70 80 80 110 110 115 115 115 135 135 140 140 190	03/09→12/16 06/06→12/09 02/08→12/09 06/06→12/09 02/08→12/09 09/08→12/18 09/08→12/18 03/09→12/18 02/08→12/09 02/08→12/09 03/09→12/18 03/09→12/18 06/06→12/16		→ 09/09			24.2125-1750.3 011050	Ø 25,4 ohne Bremsflüssigkeitsbehälter
				10/09→			24.2126-1704.3 010990 24.2126-1708.3 011128	TRW Ø 27 Ø 27 ohne Bremsflüssigkeitsbehälter
MERCEDES-BENZ - SPRINTER 3,5-t Kasten (B906) 06/06→09/20								
 Hauptbremszylinder								
309 CDI 310 CDI 311 CDI 311 CDI 4x4 313 CDI 313 CDI 4x4 315 CDI 315 CDI 4x4 316 316 CDI 316 CDI 4x4 316 NGT 318 CDI 318 CDI 4x4 319 CDI / BlueTEC 319 CDI / BlueTEC 4x4 324	65 70 80 80 95 95 110 110 115 120 120 115 135 135 140 140 190	06/06→12/09 03/09→12/16 06/06→12/09 02/08→12/09 06/06→12/16 03/09→12/16 06/06→12/09 02/08→12/09 09/08→12/18 03/09→12/18 03/09→12/18 09/08→12/18 06/06→12/09 02/08→12/09 03/09→12/18 03/09→12/18 06/06→12/16		→ 09/09			24.2125-1750.3 011050	Ø 25,4 ohne Bremsflüssigkeitsbehälter
				10/09→			24.2126-1704.3 010990 24.2126-1708.3 011128	TRW Ø 27 Ø 27 ohne Bremsflüssigkeitsbehälter
311 CDI 314 CDI 314 CDI 4x4 →	84 105 105	05/16→12/18 05/16→12/18 05/16→12/18					24.2126-1704.3 010990	TRW Ø 27













	kw			 	! #		
MERCEDES-BENZ - SPRINTER 3,5-t Kasten (B906) 06/06→09/20							
 Hauptbremszylinder							
315 CDI 316 LGT	110 115	12/14→09/20 01/11→12/18				24.2126-1708.3 011128	Ø 27 ohne Bremsflüssigkeitsbehälter
MERCEDES-BENZ - SPRINTER 3,5-t Kasten (B907, B910) 02/18→							
 Hauptbremszylinder							
311 CDI 311 CDI RWD 314 CDI 314 CDI All-wheel Drive 314 CDI RWD 315 CDI 315 CDI RWD 316 CDI All-wheel Drive 316 CDI RWD 317 CDI 317 CDI RWD 319 CDI All-wheel Drive 319 CDI RWD eSPRINTER	84 84 105 105 105 110 110 120 120 125 125 140 140 85	02/18→ 02/18→ 02/18→12/21 01/19→12/21 02/18→12/21 10/21→ 06/20→ 01/19→12/21 02/18→12/21 03/22→ 06/20→ 01/19→ 02/18→ 02/20→12/23				24.2126-1708.3 011128	Ø 27 ohne Bremsflüssigkeitsbehälter
MERCEDES-BENZ - SPRINTER 3,5-t Pritsche/Fahrgestell (B906) 06/06→12/18							
 Hauptbremszylinder							
309 CDI 310 CDI 311 CDI 311 CDI 4x4 313 CDI 313 CDI 4x4 315 CDI 315 CDI 4x4 316 316 CDI 316 CDI 4x4 316 NGT 318 CDI 318 CDI 4x4 319 CDI / BlueTEC 324	65 70 80 80 95 95 110 110 115 120 120 115 135 135 140 190	06/06→12/09 03/09→12/16 06/06→12/09 02/08→12/09 06/06→12/16 06/06→12/16 06/06→12/09 02/08→12/09 09/08→12/18 03/09→12/18 03/09→12/18 09/08→12/18 06/06→12/09 02/08→12/09 03/09→12/18 06/06→12/16		→ 09/09 10/09→		24.2125-1750.3 011050 24.2126-1704.3 010990 24.2126-1708.3 011128	Ø 25,4 ohne Bremsflüssigkeitsbehälter TRW Ø 27 Ø 27 ohne Bremsflüssigkeitsbehälter
311 CDI 314 CDI 314 CDI 4x4 316 LGT 319 CDI / BlueTEC 4x4	84 105 105 115 140	05/16→12/18 04/16→12/18 05/16→12/18 01/11→12/18 03/09→12/18				24.2126-1704.3 010990 24.2126-1708.3 011128	TRW Ø 27 Ø 27 ohne Bremsflüssigkeitsbehälter
MERCEDES-BENZ - SPRINTER 3,5-t Pritsche/Fahrgestell (B907, B910) 02/18→							
 Hauptbremszylinder							
311 CDI 311 CDI RWD 314 CDI 314 CDI All-wheel Drive 314 CDI RWD 315 CDI 315 CDI RWD 316 CDI All-wheel Drive 316 CDI RWD 317 CDI 317 CDI RWD 318 CDI 319 CDI All-wheel Drive 319 CDI RWD	84 84 105 105 105 110 110 120 120 125 125 130 140 140	02/18→ 02/18→ 02/18→12/21 01/19→12/21 02/18→12/21 06/20→ 06/20→ 01/19→12/21 02/18→12/21 02/18→ 06/20→ 02/18→12/21 01/19→ 02/18→				24.2126-1708.3 011128	Ø 27 ohne Bremsflüssigkeitsbehälter
MERCEDES-BENZ - SPRINTER 3,5-t Tourer Bus (B907) 02/18→							
 Hauptbremszylinder							
311 CDI 314 CDI 314 CDI All-wheel Drive 315 CDI 316 CDI 316 CDI All-wheel Drive 317 CDI 319 CDI 319 CDI All-wheel Drive	84 105 105 110 120 120 125 140 140	02/18→ 02/18→12/21 01/19→12/21 10/21→ 02/18→12/21 01/19→12/21 10/21→ 02/18→ 01/19→				24.2126-1708.3 011128	Ø 27 ohne Bremsflüssigkeitsbehälter
MERCEDES-BENZ - SPRINTER 3-t Bus (B903) 01/95→05/12							
 Hauptbremszylinder							
308 CDI →	60	04/00→05/06		→ A905511 / R400726		24.2123-1711.3 010518	Ø 23,8













	kw			 	! #		
MERCEDES-BENZ - SPRINTER 3-t Bus (B903) 01/95→05/12							
 Hauptbremszylinder							
308 D	58 - 60	02/95→04/00		A905512 / R400727→		24.2123-1754.3 010741	Ø 23,8
310 D 4x4	75	05/97→08/02					
311 CDI	80	04/00→05/06					
311 CDI 4x4	80	08/02→05/06					
312 D 2.9	90	02/95→04/00					
312 D 2.9 4x4	90	05/97→08/02					
313 CDI	95	04/00→05/06					
313 CDI 4x4	95	08/02→05/06					
314	105	02/95→05/06					
314 4x4	105	02/95→05/06					
314 NGT	95	02/95→05/06					
316 CDI	115	04/00→05/06					
316 CDI 4x4	115	08/02→05/06					
MERCEDES-BENZ - SPRINTER 3-t Bus (B906) 06/06→12/19							
 Hauptbremszylinder							
209 CDI	65	04/12→12/19				24.2126-1704.3 010990	TRW Ø 27
211 CDI	84	04/16→12/18				24.2126-1708.3 011128	Ø 27 ohne Bremsflüssigkeitsbehälter
214 CDI	105	04/16→12/18					
218 CDI	135	04/12→12/18					
210 CDI	70	03/09→12/16		→ 09/09		24.2125-1750.3 011050	Ø 25,4 ohne Bremsflüssigkeitsbehälter
211 CDI	80	06/06→12/09					
213 CDI	95	06/06→12/16		10/09→		24.2126-1704.3 010990	TRW Ø 27
215 CDI	110	06/06→12/09				24.2126-1708.3 011128	Ø 27 ohne Bremsflüssigkeitsbehälter
216	115	03/09→12/18					
216 CDI	120	06/09→12/18					
224	190	06/06→12/13					
MERCEDES-BENZ - SPRINTER 3-t Kasten (B903) 01/95→05/12							
 Hauptbremszylinder							
308 CDI	60	04/00→05/06		→ A905511 / R400726		24.2123-1711.3 010518	Ø 23,8
308 D 2.3	58 - 60	02/95→04/00		A905512 / R400727→		24.2123-1754.3 010741	Ø 23,8
310 D 2.9	75	02/95→04/00					
311 CDI	80	04/00→05/06					
311 CDI 4x4	80	08/02→05/06					
312 D 2.9	90	02/95→04/00					
312 D 2.9 4x4	90	05/97→08/02					
313 CDI	95	04/00→05/06					
313 CDI 4x4	95	08/02→05/06					
314	105	02/95→05/06					
314 4x4	105	02/95→05/06					
314 NGT	95	02/95→05/06					
316 CDI	115	04/00→05/06					
316 CDI 4x4	115	02/01→05/06					
MERCEDES-BENZ - SPRINTER 3-t Kasten (B906) 06/06→12/18							
 Hauptbremszylinder							
209 CDI	65	06/06→12/09		→ 09/09		24.2125-1750.3 011050	Ø 25,4 ohne Bremsflüssigkeitsbehälter
210 CDI	70	03/09→12/16					
211 CDI	80	06/06→12/09		10/09→		24.2126-1704.3 010990	TRW Ø 27
213 CDI	95	06/06→12/16				24.2126-1708.3 011128	Ø 27 ohne Bremsflüssigkeitsbehälter
215 CDI	110	06/06→12/09					
216	115	09/08→12/18					
216 CDI	120	03/09→12/18					
218 CDI	135	06/06→12/09					
219 CDI / BlueTEC	140	03/09→12/18					
224	190	06/06→12/16					
211 CDI	84	04/16→12/18				24.2126-1704.3 010990	TRW Ø 27
214 CDI	105	04/16→12/18				24.2126-1708.3 011128	Ø 27 ohne Bremsflüssigkeitsbehälter
MERCEDES-BENZ - SPRINTER 3-t Kasten (B910) 02/18→							
 Hauptbremszylinder							
211 CDI	84	02/18→				24.2126-1708.3 011128	Ø 27 ohne Bremsflüssigkeitsbehälter
214 CDI	105	02/18→12/21					
215 CDI	110	10/21→					
MERCEDES-BENZ - SPRINTER 3-t Pritsche/Fahrgestell (B903) 01/95→05/12							
 Hauptbremszylinder							
308 CDI	60	04/00→05/06		→ A905511 / R400726		24.2123-1711.3 010518	Ø 23,8
308 D 2.3	58 - 60	02/95→04/00		A905512 / R400727→		24.2123-1754.3 010741	Ø 23,8
310 D 2.9	75	01/97→04/00					
311 CDI	80	04/00→05/06					
311 CDI 4x4	80	04/00→05/06					
→							













	kw					! #		
MERCEDES-BENZ - SPRINTER 3-t Pritsche/Fahrgestell (B903) 01/95→05/12								
 Hauptbremszylinder								
312 D 2.9	85	02/95→09/01			→ A905511 / R400726		24.2123-1711.3 010518	Ø 23,8
313 CDI	95	04/00→05/06			A905512 / R400727→		24.2123-1754.3 010741	Ø 23,8
313 CDI 4x4	95	04/00→05/06						
314	105	02/95→05/06						
314 4x4	105	02/95→05/06						
314 NGT	95	02/95→05/06						
316 CDI	115	04/00→05/06						
316 CDI 4x4	115	08/02→05/06						
MERCEDES-BENZ - SPRINTER 3-t Pritsche/Fahrgestell (B906) 06/06→12/18								
 Hauptbremszylinder								
209 CDI	65	06/06→12/09			→ 09/09		24.2125-1750.3 011050	Ø 25,4 ohne Bremsflüssigkeitsbehälter
210 CDI	70	03/09→12/16						
211 CDI	80	06/06→12/09						
213 CDI	95	06/06→12/16			10/09→		24.2126-1704.3 010990	TRW Ø 27
215 CDI	110	06/06→12/09					24.2126-1708.3 011128	Ø 27 ohne Bremsflüssigkeitsbehälter
216	115	09/08→12/18						
216 CDI	120	03/09→12/18						
218 CDI	135	06/06→12/09						
219 CDI / BlueTEC	140	03/09→12/18						
224	190	06/06→12/16						
211 CDI	84	04/16→12/18					24.2126-1704.3 010990	TRW Ø 27
214 CDI	105	04/16→12/18					24.2126-1708.3 011128	Ø 27 ohne Bremsflüssigkeitsbehälter
MERCEDES-BENZ - SPRINTER 3-t Pritsche/Fahrgestell (B910, B907) 02/18→								
 Hauptbremszylinder								
211 CDI	84	02/18→					24.2126-1708.3 011128	Ø 27 ohne Bremsflüssigkeitsbehälter
211 CDI RWD	84	02/18→						
214 CDI	105	02/18→12/21						
214 CDI RWD	105	02/18→12/21						
215 CDI	110	10/21→						
215 CDI RWD	110	06/20→						
216 CDI RWD	120	02/18→12/21						
217 CDI RWD	125	06/20→						
MERCEDES-BENZ - SPRINTER 3-t Tourer Bus (B907) 02/18→								
 Hauptbremszylinder								
211 CDI	84	02/18→					24.2126-1708.3 011128	Ø 27 ohne Bremsflüssigkeitsbehälter
214 CDi	105	02/18→12/21						
215 CDI	110	10/21→						
216 CDi	120	02/18→12/21						
217 CDI	125	10/21→						
MERCEDES-BENZ - SPRINTER 4,6-t Bus (B906) 06/06→09/20								
 Hauptbremszylinder								
415 CDI	110	06/06→09/20					24.2126-1704.3 010990	TRW Ø 27
							24.2126-1708.3 011128	Ø 27 ohne Bremsflüssigkeitsbehälter
MERCEDES-BENZ - SPRINTER 4,6-t Kasten (B906) 06/06→09/20								
 Hauptbremszylinder								
411 CDI	80	06/09→12/18			→ 09/09		24.2125-1750.3 011050	Ø 25,4 ohne Bremsflüssigkeitsbehälter
413 CDI	95	06/06→12/16						
415 CDI	110	06/09→12/09						
416 CDI	120	03/09→12/18			10/09→		24.2126-1704.3 010990	TRW Ø 27
418 CDI	135	06/09→05/16					24.2126-1708.3 011128	Ø 27 ohne Bremsflüssigkeitsbehälter
419 CDI	140	03/09→12/18						
424	190	06/06→12/16						
411 CDI	84	04/16→12/18					24.2126-1704.3 010990	TRW Ø 27
414 CDI	105	05/16→12/18					24.2126-1708.3 011128	Ø 27 ohne Bremsflüssigkeitsbehälter
414 CDI 4x4	105	05/16→12/18						
416 CDI 4x4	120	11/13→12/18					24.2125-1750.3 011050	Ø 25,4 ohne Bremsflüssigkeitsbehälter
							24.2126-1704.3 010990	TRW Ø 27
							24.2126-1708.3 011128	Ø 27 ohne Bremsflüssigkeitsbehälter
MERCEDES-BENZ - SPRINTER 4,6-t Pritsche/Fahrgestell (B906) 06/06→09/20								
 Hauptbremszylinder								
411 CDI	80	06/09→12/18			→ 09/09		24.2125-1750.3 011050	Ø 25,4 ohne Bremsflüssigkeitsbehälter
413 CDI	95	06/06→12/16						
→								













	kw					! #		
MERCEDES-BENZ - SPRINTER 4,6-t Pritsche/Fahrgestell (B906) 06/06—09/20								
 Hauptbremszylinder								
415 CDI	110	06/06→12/09		10/09→			24.2126-1704.3 010990	TRW Ø 27
416 CDI	120	03/09→12/18					24.2126-1708.3 011128	Ø 27 ohne Bremsflüssigkeitsbehälter
418 CDI	135	06/06→12/09						
419 CDI	140	03/09→12/18						
424	190	06/06→12/16						
411 CDI	84	04/16→12/18					24.2126-1704.3 010990	TRW Ø 27
414 CDI	105	05/16→12/18					24.2126-1708.3 011128	Ø 27 ohne Bremsflüssigkeitsbehälter
415 CDI	110	01/12→09/20						
MERCEDES-BENZ - SPRINTER 4-t Bus (B904) 02/96→05/06								
 Hauptbremszylinder								
408 CDI	60	04/00→05/06		→ A906425 / R400726			24.2125-1727.3 010723	Ø 25,4
411 CDI	80	04/00→05/06						
413 CDI	95	04/00→05/06		A906426 / R400727→			24.2125-1728.3 010751	Ø 25,4
414	105	02/96→05/06						
416 CDI	115	04/00→05/06						
MERCEDES-BENZ - SPRINTER 4-t Kasten (B904) 02/95→05/12								
 Hauptbremszylinder								
408 CDI	60	04/00→05/06		→ A906425 / R400726			24.2125-1727.3 010723	Ø 25,4
408 D	58	02/96→05/06						
410 D 4x4	75	05/97→05/06		A906426 / R400727→			24.2125-1728.3 010751	Ø 25,4
411 CDI	80	04/00→05/06						
411 CDI 4x4	80	04/00→05/06						
412 D	85 - 90	02/96→05/06						
412 D 4x4	85 - 90	05/97→05/06						
413 CDI	95	04/00→05/06						
413 CDI 4x4	95	04/00→05/06						
414	105	02/96→05/06						
414 4x4	105	05/97→05/06						
414 D 4x4	90	05/97→05/06						
414 NGT	95	02/95→05/06						
416 CDI	115	04/00→05/06						
416 CDI 4x4	115	04/00→05/06						
410 D	75	02/96→05/06		09/96→; → A906425 / R400726			24.2125-1727.3 010723	Ø 25,4
				A906426 / R400727→			24.2125-1728.3 010751	Ø 25,4
MERCEDES-BENZ - SPRINTER 4-t Kasten (B907, B910) 02/18→								
 Hauptbremszylinder								
411 CDI	84	02/18→12/21					24.2126-1708.3 011128	Ø 27 ohne Bremsflüssigkeitsbehälter
411 CDI RWD	84	02/18→						
414 CDI	105	02/18→12/21						
414 CDI All-wheel Drive	105	01/19→12/21						
414 CDI RWD	105	02/18→12/21						
415 CDI	110	10/21→						
415 CDI RWD	110	10/21→						
416 CDI All-wheel Drive	120	01/19→12/21						
416 CDI RWD	120	02/18→12/21						
417 CDI RWD	125	06/20→						
419 CDI All-wheel Drive	140	01/19→						
419 CDI RWD	140	02/18→						
MERCEDES-BENZ - SPRINTER 4-t Pritsche/Fahrgestell (B904) 02/95→05/12								
 Hauptbremszylinder								
408 CDI	60	04/00→05/06		→ A906425 / R400726			24.2125-1727.3 010723	Ø 25,4
408 D	58	02/96→05/06						
410 D 4x4	75	05/97→05/06		A906426 / R400727→			24.2125-1728.3 010751	Ø 25,4
411 CDI	80	04/00→05/06						
411 CDI 4x4	80	04/00→05/06						
412 D	85 - 90	02/96→05/06						
412 D 4x4	85 - 90	05/97→05/06						
413 CDI	95	04/00→05/06						
413 CDI 4x4	95	04/00→05/06						
414	105	02/95→05/06						
414 4x4	105	05/97→05/06						
416 CDI	115	04/00→05/06						
416 CDI 4x4	115	04/00→05/06						
410 D	75	02/96→05/06		09/96→; → A906425 / R400726			24.2125-1727.3 010723	Ø 25,4
				A906426 / R400727→			24.2125-1728.3 010751	Ø 25,4



























	kW					! #		
MERCEDES-BENZ - SPRINTER 4-t Pritsche/Fahrgestell (B907, B910) 02/18→								
 Hauptbremszylinder								
411 CDI	84	02/18→12/21					24.2126-1708.3 011128	Ø 27 ohne Bremsflüssigkeitsbehälter
411 CDI RWD	84	02/18→						
414 CDI	105	02/18→12/21						
414 CDI All-wheel Drive	105	01/19→12/21						
414 CDI RWD	105	02/18→12/21						
415 CDI	110	06/20→						
415 CDI RWD	110	10/21→						
416 CDI All-wheel Drive	120	01/19→12/21						
416 CDI RWD	120	02/18→12/21						
417 CDI	125	02/18→						
417 CDI RWD	125	10/21→						
418 CDI	130	02/18→12/21						
419 CDI All-wheel Drive	140	01/19→						
419 CDI RWD	140	02/18→						
MERCEDES-BENZ - SPRINTER 4-t Tourer Bus (B907) 02/18→								
 Hauptbremszylinder								
411 CDI	84	02/18→12/21					24.2126-1708.3 011128	Ø 27 ohne Bremsflüssigkeitsbehälter
414 CDI	105	09/19→12/21						
419 CDI	140	02/18→12/21						
MERCEDES-BENZ - SPRINTER 5-t Bus (B906) 06/06→09/20								
 Hauptbremszylinder								
513 CDI	95	03/09→12/16		→ 09/09			24.2125-1750.3 011050	Ø 25,4 ohne Bremsflüssigkeitsbehälter
515 CDI	110	06/06→09/20						
516 CDI	120	03/09→12/18						
519 CDI	140	03/09→12/18		10/09→			24.2126-1704.3 010990	TRW Ø 27
							24.2126-1708.3 011128	Ø 27 ohne Bremsflüssigkeitsbehälter
MERCEDES-BENZ - SPRINTER 5-t Kasten (B906) 06/06→09/20								
 Hauptbremszylinder								
509 CDI	65	06/06→12/09		→ 09/09			24.2125-1750.3 011050	Ø 25,4 ohne Bremsflüssigkeitsbehälter
510 CDI	70	03/09→12/16						
511 CDI	80	06/06→12/09						
511 CDI 4x4	80	06/06→12/09		10/09→			24.2126-1704.3 010990	TRW Ø 27
513 CDI	95	03/09→05/16					24.2126-1708.3 011128	Ø 27 ohne Bremsflüssigkeitsbehälter
513 CDI 4x4	95	03/09→12/16						
515 CDI	110	06/06→12/09						
515 CDI 4x4	110	06/06→12/09						
516	115	03/09→12/18						
516 CDI	120	03/09→12/18						
516 CDI 4x4	120	03/09→12/18						
516 NGT	115	03/09→12/18						
518 CDI	135	06/06→12/09						
518 CDI 4x4	135	06/06→12/16						
519 CDI / BlueTEC	140	03/09→12/18						
519 CDI / BlueTEC 4x4	140	03/09→12/18						
524	190	06/06→12/16						
511 CDI	84	05/16→12/18					24.2126-1704.3 010990	TRW Ø 27
514 CDI	105	05/16→12/18					24.2126-1708.3 011128	Ø 27 ohne Bremsflüssigkeitsbehälter
514 CDI 4x4	105	05/16→12/18						
515 CDI	110	06/11→09/20						
513 CDI	95	06/06→12/16		03/09→ 09/09			24.2125-1750.3 011050	Ø 25,4 ohne Bremsflüssigkeitsbehälter
				10/09→			24.2126-1704.3 010990	TRW Ø 27
							24.2126-1708.3 011128	Ø 27 ohne Bremsflüssigkeitsbehälter
MERCEDES-BENZ - SPRINTER 5-t Kasten (B907) 02/18→								
 Hauptbremszylinder								
511 CDI	84	02/18→12/21					24.2126-1708.3 011128	Ø 27 ohne Bremsflüssigkeitsbehälter
514 CDI	105	02/18→12/21						
515 CDI	110	10/21→						
516 CDI	120	02/18→12/21						
516 CDI All-wheel Drive	120	01/19→12/21						
517 CDI	125	06/20→						
519 CDI	140	02/18→						
519 CDI All-wheel Drive	140	01/19→						
MERCEDES-BENZ - SPRINTER 5-t Pritsche/Fahrgestell (B906) 06/06→09/20								
 Hauptbremszylinder								
509 CDI	65	06/06→12/09		→ 09/09			24.2125-1750.3 011050	Ø 25,4 ohne Bremsflüssigkeitsbehälter
510 CDI	70	03/09→12/16						
511 CDI	80	06/06→12/09						
511 CDI 4x4	80	06/06→12/09		10/09→			24.2126-1704.3 010990	TRW Ø 27
→								













	kW					! #		
MERCEDES-BENZ - SPRINTER 5-t Pritsche/Fahrgestell (B906) 06/06→09/20								
 Hauptbremszylinder								
513 CDI 515 CDI 515 CDI 4x4 516 516 CDI 516 NGT 518 CDI 518 CDI 4x4 519 CDI / BlueTEC 519 CDI / BlueTEC 4x4 524	95 110 110 115 120 115 135 135 140 140 190	03/09→05/16 06/06→12/09 06/06→12/09 09/08→12/18 03/09→12/18 09/08→12/18 06/06→12/09 06/06→12/09 03/09→12/18 03/09→12/18 06/06→12/16		10/09→			24.2126-1708.3 011128	Ø 27 ohne Bremsflüssigkeitsbehälter
511 CDI 513 CDI 4x4 514 CDI 514 CDI 4x4 515 CDI 516 CDI 4x4	84 95 105 105 110 120	05/16→12/18 05/11→12/16 05/16→12/18 05/16→12/18 06/11→09/20 03/09→12/18					24.2126-1704.3 010990 24.2126-1708.3 011128	TRW Ø 27 Ø 27 ohne Bremsflüssigkeitsbehälter
513 CDI	95	06/06→12/16		03/09→ 09/09			24.2125-1750.3 011050	Ø 25,4 ohne Bremsflüssigkeitsbehälter
				10/09→			24.2126-1704.3 010990 24.2126-1708.3 011128	TRW Ø 27 Ø 27 ohne Bremsflüssigkeitsbehälter
MERCEDES-BENZ - SPRINTER 5-t Pritsche/Fahrgestell (B907) 02/18→								
 Hauptbremszylinder								
511 CDI 514 CDI 515 CDI RWD 516 CDI 516 CDI All-wheel Drive 519 CDI 519 CDI All-wheel Drive 519 CDI RWD	84 105 110 120 120 140 140 140	02/18→12/21 02/18→12/21 10/21→ 02/18→12/21 01/19→12/21 02/18→12/21 01/19→ 10/21→					24.2126-1708.3 011128	Ø 27 ohne Bremsflüssigkeitsbehälter
MERCEDES-BENZ - Vaneo (414) 02/02→07/05								
 Hauptbremszylinder								
1.6 1.7 CDI 1.9	60 - 75 55 - 67 92	02/02→07/05 02/02→07/05 02/02→07/05					24.4123-1703.3 010831	TRW Ø 23,8
MERCEDES-BENZ - VARIO Bus (B670) 08/96→								
 Hauptbremszylinder								
O 810 O 812 O 813 O 814 O 815 O 816 D O 818 D	75 90 95 100 112 115 130	09/96→12/10 09/96→12/10 01/06→12/13 09/96→12/10 09/96→12/10 01/06→12/13 09/06→		→ 12/13			03.2128-1203.3 010922	ATE Ø 28,6
MERCEDES-BENZ - VARIO Kasten (B667, B670, B668) 09/96→								
 Hauptbremszylinder								
512 D 612 D 613 D 614 D 615 D 616 D 618 D 812 D 813 D 814 D 814 DA 4x4 813 DA 815 D →	90 90 95 - 100 95 - 100 112 - 115 130 90 95 - 100 95 - 100 95 - 100 112 - 115	09/96→12/10 09/96→12/10 09/96→12/13 09/96→12/13 09/96→12/13 09/96→12/13 09/96→12/13 09/96→12/13 09/96→12/13 09/96→12/13 09/96→12/13 09/96→12/13 09/96→12/13 09/96→12/13 09/96→12/13 09/96→12/13 09/96→12/13					03.2128-1203.3 010922	ATE Ø 28,6

















	kW			 	! #		
MERCEDES-BENZ - VARIO Kasten (B667, B670, B668) 09/96→							
 Hauptbremszylinder							
816 D	112 - 115	09/96→12/13				03.2128-1203.3 010922	ATE Ø 28,6
815 DA	112 - 115	09/96→12/13					
816 DA 4x4	112 - 115	09/96→12/13					
818 D	130	09/06→12/13					
MERCEDES-BENZ - VARIO Pritsche/Fahrgestell (B670, B668, B667) 09/96→							
 Hauptbremszylinder							
512 D	90	09/96→12/10				03.2128-1203.3 010922	ATE Ø 28,6
612 D	90	09/96→12/10					
613 D	95 - 100	09/96→12/13					
614 D	95 - 100	09/96→12/13					
812 D	90	09/96→12/10					
813 D	95 - 100	09/96→12/13					
814 D	95 - 100	09/96→12/13					
814 DA 4x4	95 - 100	09/96→12/13					
813 DA	95 - 100	09/96→12/13					
815 D	110 - 115	09/96→12/13					
816 D	112 - 115	09/96→12/13					
815 DA	112 - 115	09/96→12/13					
816 DA 4x4	112 - 115	09/96→12/13					
618 D	130	09/06→		→ 12/13		03.2128-1203.3 010922	ATE Ø 28,6
818 D	130	09/06→					
818 DA 4x4	130	09/06→					
MERCEDES-BENZ - VARIO Triebkopf 09/96→							
 Hauptbremszylinder							
613 D	95	01/06→12/13				03.2128-1203.3 010922	ATE Ø 28,6
614 D	95	01/06→12/13					
615 D	115	01/06→12/13					
616 D	115	01/06→12/13					
618 D	130	09/06→12/13					
810 DT	75	09/96→06/06					
812 DT	90	09/96→06/06					
814 DT	100	09/96→06/06					
816 DT	112	09/96→06/06					
MERCEDES-BENZ - VIANO (W639) 09/03→							
 Hauptbremszylinder							
3.2	140 - 160	09/03→		→ 02/14		24.2123-1772.3 010858	BOS Ø 23,8
3.5	190	09/07→					
3.7	170	06/04→					
CDI 2.0	80	09/03→					
CDI 2.2	100 - 120	09/03→					
CDI 2.2 4-matic	100 - 120	07/10→					
CDI 3.0	150 - 165	03/06→					
3.7	165	06/04→07/07				24.2123-1772.3 010858	BOS Ø 23,8
CDI 2.0	85	08/05→					
CDI 2.0 4-matic	85	03/06→					
CDI 2.2	110	01/14→					
CDI 2.0 4-matic	80	07/05→		07/10→ 02/14		24.2123-1772.3 010858	BOS Ø 23,8
CDI 2.2 4-matic	110	07/05→					
CDI 2.2	70	09/10→		→ 3558104		24.2123-1772.3 010858	BOS Ø 23,8
				→ 3558105→; → 02/14		24.2123-1778.3 010947	TRW Ø 23,8
MERCEDES-BENZ - VITO / MIXTO Kasten (W639) 08/03→							
 Hauptbremszylinder							
109 CDI	65 - 70	09/03→		→ 3558104		24.2123-1772.3 010858	BOS Ø 23,8
110 CDI	70	09/10→		3558105→; → 02/14		24.2123-1778.3 010947	TRW Ø 23,8
111 CDI	80 - 85	09/03→					
→							













	kw					! #		
MERCEDES-BENZ - VITO / MIXTO Kasten (W639) 08/03→								
 Hauptbremszylinder								
111 CDI 4x4	80	09/07→		→ 3558104		24.2123-1772.3	010858	BOS Ø 23,8
113 CDI	100	09/10→						
113 CDI 4x4	100	09/10→		3558105→; → 02/14		24.2123-1778.3	010947	TRW Ø 23,8
115 CDI	110	09/03→						
116 CDI	120	09/10→						
116 CDI 4x4	120	09/10→						
119	140	09/03→						
122	160	09/03→						
122 CDI	165	09/10→						
126	190	09/07→						
115 CDI 4x4	110	07/06→		09/07→; → 3558104		24.2123-1772.3	010858	BOS Ø 23,8
120 CDI	150	07/06→		3558105→; → 02/14		24.2123-1778.3	010947	TRW Ø 23,8
123	165 - 170	06/04→07/08		→ 3558104		24.2123-1772.3	010858	BOS Ø 23,8
				3558105→		24.2123-1778.3	010947	TRW Ø 23,8
MERCEDES-BENZ - VITO Bus (W638) 02/96→07/03								
 Hauptbremszylinder								
108 CDI 2.2	60	03/99→07/03		- ABS		24.2123-1712.3	010519	Ø 23,8
110 CDI 2.2	75	03/99→07/03						
112 CDI 2.2	90	03/99→07/03		+ ABS		24.2123-1729.3	010567	Ø 23,8
114 2.3	105	12/96→07/03						
108 D 2.3	58	02/96→07/03		03/96→; - ABS		24.2123-1712.3	010519	Ø 23,8
110 TD 2.3	72	02/96→07/03						
113 2.0	95	02/96→07/03		03/96→; + ABS		24.2123-1729.3	010567	Ø 23,8
MERCEDES-BENZ - VITO Bus (W639) 09/03→								
 Hauptbremszylinder								
109 CDI	65 - 70	09/03→		→ 3558104		24.2123-1772.3	010858	BOS Ø 23,8
109 CDI 4x4	70	09/07→08/14		3558105→; → 02/14		24.2123-1778.3	010947	TRW Ø 23,8
110 CDI	70	09/10→08/14						
111 CDI	80 - 85	09/03→						
111 CDI 4x4	80	09/07→08/14						
113 CDI	100	09/10→						
113 CDI 4x4	100	09/10→08/14						
115 CDI	110	09/03→						
115 CDI 4x4	110	09/07→08/14						
116 CDI	120	09/10→						
116 CDI 4x4	120	09/10→08/14						
119	140	09/03→						
122	160	09/03→						
122 CDI	165	09/10→						
126	190	09/07→						
120 CDI	150	07/06→		09/07→; → 3558104		24.2123-1772.3	010858	BOS Ø 23,8
				3558105→; → 02/14		24.2123-1778.3	010947	TRW Ø 23,8
123	165 - 170	06/04→07/08		→ 3558104		24.2123-1772.3	010858	BOS Ø 23,8
				3558105→		24.2123-1778.3	010947	TRW Ø 23,8
MERCEDES-BENZ - VITO Kasten (W638) 03/97→07/03								
 Hauptbremszylinder								
108 CDI 2.2	60	03/99→07/03		- ABS		24.2123-1712.3	010519	Ø 23,8
108 D 2.3	58	03/97→07/03						
110 CDI 2.2	75	03/99→07/03		+ ABS		24.2123-1729.3	010567	Ø 23,8
110 D 2.3	72	03/97→07/03						
112 CDI 2.2	90	03/99→07/03						
113 2.0	95	03/97→07/03						
114 2.3	105	03/97→07/03						
MERCEDES-BENZ - V-KLASSE (638/2) 02/96→07/03								
 Hauptbremszylinder								
V 200	95	02/97→07/03		- ABS		24.2123-1712.3	010519	Ø 23,8
V 200 CDI	75	03/99→07/03						
V 220 CDI	90	03/99→07/03		+ ABS		24.2123-1729.3	010567	Ø 23,8
V 230	105	10/96→07/03						
V 230 TD	72	09/96→07/03						
V 280	128	08/97→07/03		09/97→; - ABS		24.2123-1712.3	010519	Ø 23,8
				09/97→; + ABS		24.2123-1729.3	010567	Ø 23,8
MINI - MINI (F55) 09/13→								
 Hauptbremszylinder								
Cooper	100	09/13→		10/14→		24.4122-1722.3	011085	Ø 22,2 ohne Bremsflüssigkeitsbehälter
Cooper D	85	10/13→						



















	kw					! #		
MINI - MINI (F55) 09/13→								
 Hauptbremszylinder								
Cooper S	120 - 141	09/13→		10/14→			24.4122-1722.3 011085	Ø 22,2 ohne Bremsflüssigkeitsbehälter
Cooper SD	120 - 125	09/13→						
One	75	05/14→10/17						
One D	70	02/14→						
Cooper S	131	11/20→					24.4122-1722.3 011085	Ø 22,2 ohne Bremsflüssigkeitsbehälter
One	75	11/17→						
One First	55	11/17→						
Cooper S JCW	155	09/13→		09/15→			24.4123-1733.3 011108	Ø 23,8 ohne Bremsflüssigkeitsbehälter
One First	55	06/14→10/17		03/15→			24.4122-1722.3 011085	Ø 22,2 ohne Bremsflüssigkeitsbehälter
MINI - MINI (F56) 12/13→								
 Hauptbremszylinder								
Cooper S	131	11/20→					24.4122-1722.3 011085	Ø 22,2 ohne Bremsflüssigkeitsbehälter
Cooper SE / Electric	75 - 135	11/19→						
Cooper S JCW	155	12/13→		03/15→			24.4123-1733.3 011108	Ø 23,8 ohne Bremsflüssigkeitsbehälter
John Cooper Works	170	03/15→					24.4123-1733.3 011108	Ø 23,8 ohne Bremsflüssigkeitsbehälter
John Cooper Works GP	225	03/20→						
MINI - MINI (R50, R53) 06/01→09/06								
 Bremskraftverstärker								
Cooper	85	06/01→09/06					03.7860-1402.4 300228	ATE Ø 10" pneumatisch
Cooper S	125	07/04→09/06						
John Cooper Works	160	03/06→09/06						
One	55 - 66	06/01→09/06						
One D	55 - 65	06/03→09/06						
S Works	149	11/03→06/05						
Works	155	11/03→09/06						
Cooper S	120	03/02→09/06		07/02→			03.7860-1402.4 300228	ATE Ø 10" pneumatisch
 Hauptbremszylinder								
Cooper	85	06/01→09/06		+ DSC			03.2122-1824.3 010892	ATE Ø 22,2
Cooper S	125	07/04→09/06		- DSC			03.2122-1853.3 010893	ATE Ø 22,2
John Cooper Works	160	03/06→09/06						
One	55 - 66	06/01→09/06						
One D	55 - 65	06/03→09/06						
S Works	149	11/03→06/05						
Works	155	11/03→09/06						
Cooper S	120	03/02→09/06		07/02→; + DSC			03.2122-1824.3 010892	ATE Ø 22,2
				07/02→; - DSC			03.2122-1853.3 010893	ATE Ø 22,2
MINI - MINI (R56) 11/05→01/14								
 Hauptbremszylinder								
Cooper	85 - 90	09/06→11/13		03/10→			24.4123-1712.3 010897	TRW Ø 23,8
One D	66	06/09→07/10						
Cooper	88	10/06→02/12		11/06→			24.4123-1712.3 010897	TRW Ø 23,8
Cooper S	128	10/06→02/10						
Cooper D	80	11/06→09/10		04/07→			24.4123-1712.3 010897	TRW Ø 23,8
One	70	11/06→03/10						
Cooper D	82	06/10→11/13					24.4123-1712.3 010897	TRW Ø 23,8
Cooper S	120 - 135	03/10→11/13						
Cooper SD	100 - 105	02/11→11/13						
Cooper S John Cooper Works	147	01/12→11/13						
One	55 - 72	03/09→11/13						
One D	66	07/10→11/13						
One LPG	55	03/09→03/10						
Cooper S John Cooper Works	141	11/06→02/10		03/08→			24.4123-1712.3 010897	TRW Ø 23,8
John Cooper Works	155	11/07→11/13						













	kw					! #		
MINI - MINI Cabriolet (F57) 11/14→								
 Hauptbremszylinder								
Cooper Cooper D Cooper S	100 85 120 - 141	11/14→ 12/14→ 11/14→			11/15→		24.4122-1722.3 011085	Ø 22,2 ohne Bremsflüssigkeitsbehälter
Cooper S Cooper SE One	131 135 75	11/20→ 04/23→ 11/17→					24.4122-1722.3 011085	Ø 22,2 ohne Bremsflüssigkeitsbehälter
Cooper SD One	120 - 125 75	05/15→ 06/15→10/17			03/16→		24.4122-1722.3 011085	Ø 22,2 ohne Bremsflüssigkeitsbehälter
Cooper S JCW John Cooper Works	155 170	11/14→ 05/15→			03/16→		24.4123-1733.3 011108	Ø 23,8 ohne Bremsflüssigkeitsbehälter
MINI - MINI Cabriolet (R52) 04/04→07/08								
 Bremskraftverstärker								
Cooper Cooper S John Cooper Works One	85 120 - 125 155 66	04/04→07/08 07/04→07/08 07/04→11/07 07/04→11/07					03.7860-1402.4 300228	ATE Ø 10" pneumatisch
 Hauptbremszylinder								
Cooper Cooper S John Cooper Works One	85 120 - 125 155 66	04/04→07/08 07/04→07/08 07/04→11/07 07/04→11/07		+ DSC - DSC			03.2122-1824.3 010892 03.2122-1853.3 010893	ATE Ø 22,2 ATE Ø 22,2
MINI - MINI Cabriolet (R57) 10/07→06/15								
 Hauptbremszylinder								
Cooper Cooper S	85 128	12/08→06/15 12/08→07/10			01/09→		24.4123-1712.3 010897	TRW Ø 23,8
Cooper Cooper S	88 - 90 141	12/08→06/15 04/08→07/10					24.4123-1712.3 010897	TRW Ø 23,8
Cooper D	82	05/09→11/13			06/10→		24.4123-1712.3 010897	TRW Ø 23,8
Cooper D	82	02/11→05/15			→ 06/14		24.4123-1712.3 010897	TRW Ø 23,8
Cooper S	120	10/07→06/15			01/09→ 06/14		24.4123-1712.3 010897	TRW Ø 23,8
Cooper S One	135 - 147 72	02/10→06/15 09/09→06/15			03/10→ 06/14		24.4123-1712.3 010897	TRW Ø 23,8
Cooper SD	100 - 105	06/09→05/15			02/11→ 06/14		24.4123-1712.3 010897	TRW Ø 23,8
John Cooper Works	155	08/08→05/15			03/09→ 06/14		24.4123-1712.3 010897	TRW Ø 23,8
MINI - MINI CLUBMAN (F54) 11/14→								
 Hauptbremszylinder								
Cooper Cooper D Cooper S Cooper S JCW	100 100 - 110 120 - 141 155	12/14→ 12/14→ 11/14→ 11/14→06/18			07/15→		24.4122-1722.3 011085	Ø 22,2 ohne Bremsflüssigkeitsbehälter
Cooper S Cooper S ALL4	131 131	11/20→ 11/20→					24.4122-1722.3 011085	Ø 22,2 ohne Bremsflüssigkeitsbehälter
Cooper S ALL4 Cooper SD ALL4 Cooper S JCW ALL4	120 - 141 120 - 140 155	04/15→ 04/15→ 11/14→			01/16→		24.4122-1722.3 011085	Ø 22,2 ohne Bremsflüssigkeitsbehälter
Cooper SD One One D	120 - 140 75 85	02/15→ 02/15→ 02/15→			11/15→		24.4122-1722.3 011085	Ø 22,2 ohne Bremsflüssigkeitsbehälter
John Cooper Works	170	11/16→06/19					24.4123-1733.3 011108	Ø 23,8 ohne Bremsflüssigkeitsbehälter
MINI - MINI CLUBMAN (R55) 10/06→12/15								
 Hauptbremszylinder								
Cooper Cooper D →	85 - 90 80 - 82	10/07→06/14 10/07→06/14					24.4123-1712.3 010897	TRW Ø 23,8













	kW			 	! #		
MINI - MINI CLUBMAN (R55) 10/06→12/15							
 Hauptbremszylinder							
Cooper S	120 - 147	08/07→06/14				24.4123-1712.3 010897	TRW Ø 23,8
Cooper SD	100 - 105	02/11→06/14					
Cooper S John Cooper Works One	141 - 72	10/08→02/10					
One D	66	03/10→06/14					
John Cooper Works	155	03/10→06/14		03/08→		24.4123-1712.3 010897	TRW Ø 23,8
MINI - MINI CLUBVAN (R55) 12/12→06/14							
 Hauptbremszylinder							
Cooper	90	12/12→06/14				24.4123-1712.3 010897	TRW Ø 23,8
Cooper D	82	12/12→06/14					
One	72	12/12→06/14					
MINI - MINI COUNTRYMAN (F60) 10/16→							
 Hauptbremszylinder							
Cooper	100	10/16→				24.4123-1733.3 011108	Ø 23,8 ohne Bremsflüssigkeitsbehälter
Cooper ALL4	100	10/16→					
Cooper D	100 - 110	10/16→					
Cooper D ALL4	100 - 110	10/16→					
Cooper S	120 - 141	10/16→					
Cooper S ALL4	120 - 141	10/16→					
Cooper SD	120 - 140	10/16→					
Cooper SD ALL4	120 - 140	10/16→					
Cooper SE	162	07/20→					
Cooper SE ALL4	165	01/17→					
John Cooper Works ALL4	170	03/17→06/19					
One	75	07/17→					
One D	85	07/17→					
MINI - MINI COUNTRYMAN (R60) 08/10→10/16							
 Hauptbremszylinder							
Cooper	85 - 90	08/10→10/16		09/10→		24.4123-1712.3 010897	TRW Ø 23,8
Cooper D	82	08/10→10/16					
Cooper D ALL4	82	08/10→10/16					
Cooper S	120 - 135	08/10→10/16					
Cooper S ALL4	120 - 135	08/10→10/16					
One	72	08/10→10/16					
One D	66	08/10→10/16					
Cooper ALL4	90	11/12→10/16		11/14→		24.4123-1712.3 010897	TRW Ø 23,8
Cooper D	82	03/11→10/16				24.4123-1712.3 010897	TRW Ø 23,8
Cooper D ALL4	82	03/11→10/16					
Cooper S	140	07/14→10/16					
Cooper S ALL4	140	07/14→10/16					
Cooper SD	100 - 105	03/11→10/16					
Cooper SD ALL4	100 - 105	03/11→10/16					
John Cooper Works ALL4	160	11/12→10/16					
Cooper S	147	08/10→10/16		02/12→		24.4123-1712.3 010897	TRW Ø 23,8
MINI - MINI Coupe (R58) 12/10→05/15							
 Hauptbremszylinder							
1.6 Cooper	88	10/14→05/15				24.4123-1712.3 010897	TRW Ø 23,8
Cooper	85 - 90	12/10→04/15		10/11→		24.4123-1712.3 010897	TRW Ø 23,8
Cooper S	120 - 135	12/10→04/15					
Cooper SD	100 - 105	12/10→05/15					
Cooper S JCW	147	12/10→04/15					
John Cooper Works	155	12/10→05/15					















	kw					! #		
MINI - MINI PACEMAN (R61) 03/12→10/16								
 Hauptbremszylinder								
Cooper	88 - 90	04/12→09/16		11/12→			24.4123-1712.3 010897	TRW Ø 23,8
Cooper D	82	04/12→09/16						
Cooper D ALL4	82	03/12→09/16						
Cooper S ALL4	120 - 140	03/12→09/16						
Cooper SD	105	03/12→09/16						
Cooper SD ALL4	100 - 105	04/12→09/16						
Cooper ALL4	85 - 90	11/12→09/16		07/14→			24.4123-1712.3 010897	TRW Ø 23,8
Cooper ALL4	90	07/13→09/16					24.4123-1712.3 010897	TRW Ø 23,8
Cooper S	120 - 140	11/12→10/16						
John Cooper Works ALL4	160	03/13→10/16						
MINI - MINI Roadster (R59) 01/11→04/15								
 Hauptbremszylinder								
Cooper	85 - 90	11/11→04/15		02/12→			24.4123-1712.3 010897	TRW Ø 23,8
Cooper S	120 - 135	11/11→04/15						
Cooper SD	100 - 105	11/11→04/15						
Cooper S JCW	147	11/11→04/15						
John Cooper Works	155	11/11→04/15						
MITSUBISHI - CARISMA (DA_) 05/95→06/06								
 Hauptbremszylinder								
1.6	66	07/95→06/06		- ABS			24.2122-1718.3 010517	Ø 22,2
MITSUBISHI - CARISMA Stufenheck (DA_) 09/96→06/06								
 Hauptbremszylinder								
1.6	66	09/96→06/06		- ABS			24.2122-1718.3 010517	Ø 22,2
MITSUBISHI - COLT VI (Z3_A, Z2_A) 10/02→12/12								
 Hauptbremszylinder								
1.1	55	10/04→06/12		→ 09/08			24.2122-1770.3 010898	TRW Ø 22,2
1.1 LPG	55	10/04→06/12						
1.3	68 - 70	06/04→06/12		10/08→			24.4122-1717.3 010993	TRW Ø 22,2 ohne Bremsflüssigkeitsbehälter
1.3 LPG	70	06/04→06/12						
1.5	77 - 80	06/04→06/12						
1.5 CZT	110	03/05→06/12						
1.3 Flexfuel	70	10/08→06/12		für Linkslenker			24.4122-1717.3 010993	TRW Ø 22,2 ohne Bremsflüssigkeitsbehälter
1.5 Ralliart R	132	02/10→06/12						
1.5 DI-D	50 - 70	08/04→06/12					24.2122-1770.3 010898	TRW Ø 22,2
MITSUBISHI - COLT CZC VI Cabriolet (RG) 05/06→07/09								
 Hauptbremszylinder								
1.5	80	05/06→07/09					24.2122-1770.3 010898	TRW Ø 22,2
1.5 Turbo	110	05/06→07/09						
MITSUBISHI - COLT Kasten/Schrägheck (Z3_V) 08/04→06/12								
 Hauptbremszylinder								
1.5 DiD	70	08/04→06/12					24.2122-1770.3 010898	TRW Ø 22,2
NISSAN - BLUEBIRD SYLPHY / SYLPHY III (B17) 07/12→								
 Hauptbremszylinder								
1.6	86	05/13→		für Linkslenker; CVT-Automatikgetriebe (stufenlos)			24.4123-1727.3 011088	Ø 23,8 ohne Bremsflüssigkeitsbehälter
NISSAN - INTERSTAR Bus (X70) 04/02→								
 Hauptbremszylinder								
dCi 100	73	11/03→03/06		- ABS			24.2025-1708.3 010692	Ø 25,4
dCi 120	88	09/06→03/11		+ ABS			24.2123-1759.3 010768	BOS Ø 23,8
dCi 100	74	04/06→03/11		→ 06/10; - ABS			24.2025-1708.3 010692	Ø 25,4
→								



















	kw			 	! #		
NISSAN - INTERSTAR Bus (X70) 04/02→							
 Hauptbremszylinder							
dCi 150	107	09/06→03/11		→ 06/10; + ABS		24.2123-1759.3 010768	BOS Ø 23,8
dCi 115	84	04/02→08/06		→ 12/02; + ABS		24.2025-1706.3 010676	Ø 25,4
dCi 80	60	04/02→08/06		- ABS		24.2025-1708.3 010692	Ø 25,4
dCi 90	66	07/02→08/06		01/03→; + ABS		24.2123-1759.3 010768	BOS Ø 23,8
dCi 140	100	11/03→		→ 08/06; - ABS		24.2025-1708.3 010692	Ø 25,4
				→ 08/06; + ABS		24.2123-1759.3 010768	BOS Ø 23,8
NISSAN - INTERSTAR Kasten (X70) 04/02→							
 Hauptbremszylinder							
dCi 100	73	11/03→03/06		- ABS		24.2025-1708.3 010692	Ø 25,4
dCi 120	88	09/06→		+ ABS		24.2123-1759.3 010768	BOS Ø 23,8
dCi 100	74	04/06→		→ 06/10; - ABS		24.2025-1708.3 010692	Ø 25,4
dCi 150	107	09/06→		→ 06/10; + ABS		24.2123-1759.3 010768	BOS Ø 23,8
dCi 115	84	04/02→		→ 12/02; + ABS		24.2025-1706.3 010676	Ø 25,4
dCi 90	66	07/02→		→ 08/06; - ABS		24.2025-1708.3 010692	Ø 25,4
				01/03→ 08/06; + ABS		24.2123-1759.3 010768	BOS Ø 23,8
dCi 140	100	11/03→		→ 08/06; - ABS		24.2025-1708.3 010692	Ø 25,4
				→ 08/06; + ABS		24.2123-1759.3 010768	BOS Ø 23,8
dCi 80	60	04/02→08/06		→ 12/02; + ABS		24.2025-1706.3 010676	Ø 25,4
				- ABS		24.2025-1708.3 010692	Ø 25,4
				01/03→; + ABS		24.2123-1759.3 010768	BOS Ø 23,8
NISSAN - INTERSTAR Pritsche/Fahrgestell (X70) 08/03→							
 Hauptbremszylinder							
dCi 100	73	02/04→		→ 06/10; - ABS		24.2025-1708.3 010692	Ø 25,4
				→ 06/10; + ABS		24.2123-1759.3 010768	BOS Ø 23,8
dCi 115	84	08/03→		→ 08/06; - ABS		24.2025-1708.3 010692	Ø 25,4
dCi 140	100	11/03→		→ 08/06; + ABS		24.2123-1759.3 010768	BOS Ø 23,8
dCi 120	88	08/06→		- ABS		24.2025-1708.3 010692	Ø 25,4
				+ ABS		24.2123-1759.3 010768	BOS Ø 23,8
dCi 150	107	08/06→		09/06→ 06/10; - ABS		24.2025-1708.3 010692	Ø 25,4
				09/06→ 06/10; + ABS		24.2123-1759.3 010768	BOS Ø 23,8
NISSAN - KUBISTAR Kasten (X76) 08/03→							
 Hauptbremszylinder							
1.2 1.5 dCi	44 42 - 60	08/03→ 08/03→		→ 08/05; - ABS		24.2122-1727.3 010586	BDX Ø 22,2
1.2 16V	55	04/06→		→ 10/09; - ABS		24.2122-1727.3 010586	BDX Ø 22,2
1.4	55	08/03→10/09				24.2122-1727.3 010586	BDX Ø 22,2
1.5 dCi	45	08/05→10/09		09/05→; - ABS		24.2122-1727.3 010586	BDX Ø 22,2
1.5 dCi 70	50	09/05→10/09		- ABS		24.2122-1727.3 010586	BDX Ø 22,2
1.6 16V	70	08/03→10/09					
dCi 85	62	04/06→10/09					
NISSAN - MICRA II (K11) 01/92→12/07							
 Hauptbremszylinder							
1.0 i 16V	40	08/92→07/00		04/95→; - ABS		24.2119-1715.3 011095	Ø 19 ohne Bremsflüssigkeitsbehälter
1.0 i 16V	44	07/00→02/03		09/00→ 12/02; - ABS		24.2119-1715.3 011095	Ø 19 ohne Bremsflüssigkeitsbehälter
1.3 i 16V	55	08/92→09/00		04/95→ 08/00; - ABS		24.2119-1715.3 011095	Ø 19 ohne Bremsflüssigkeitsbehälter
1.4 i 16V	60	09/00→02/03		→ 12/02; - ABS		24.2119-1715.3 011095	Ø 19 ohne Bremsflüssigkeitsbehälter
1.5 D	42	02/98→02/03					
NISSAN - MICRA III (K12) 03/02→06/10							
 Bremskraftverstärker							
1.0 16V	48	01/03→06/10		für Linkslenker		03.7863-3002.4 300223	ATE Ø 10" pneumatisch
1.2	66	03/02→06/10					
1.2 16V	48 -	01/03→06/10					
	59						
1.2 LPG	59	10/02→06/10					
1.3	60	08/04→06/10					
1.4	72	03/07→06/10					
→							











	kw			 	! #		
NISSAN - MICRA III (K12) 03/02→06/10							
 Bremskraftverstärker							
1.4 16V 1.5 dCi 160 SR	65 48 - 63 81	01/03→06/10 01/03→06/10 05/05→06/10		für Linkslenker		03.7863-3002.4 300223	ATE Ø 10" pneumatisch
 Hauptbremszylinder							
1.0 16V 1.2 1.2 16V 1.2 LPG 1.3 1.4 1.4 16V 1.5 dCi 160 SR	48 66 48 - 59 59 60 72 65 48 - 63 81	01/03→06/10 03/02→06/10 01/03→06/10 10/02→06/10 08/04→06/10 03/07→06/10 01/03→06/10 01/03→06/10 05/05→06/10		für Linkslenker; + ESP		03.2123-2923.3 010791	ATE Ø 23,8
NISSAN - MICRA C+C III (K12) 08/05→06/10							
 Bremskraftverstärker							
1.4 16V 1.6 160 SR	65 81	08/05→01/09 08/05→06/10		für Linkslenker		03.7863-3002.4 300223	ATE Ø 10" pneumatisch
 Hauptbremszylinder							
1.4 16V 1.6 160 SR	65 81	08/05→01/09 08/05→06/10		+ ESP		03.2123-2923.3 010791	ATE Ø 23,8
NISSAN - NAVARA NP300 (D40) 10/04→							
 Hauptbremszylinder							
2.5 D 4WD 2.5 dCi 4WD 2.5 dCi 4x4 2.5 dCi 2.5 dCi 4WD 2.5 dCi	98 106 120 106 - 128 128 120	09/08→ 01/07→ 02/12→12/16 07/05→ 07/05→ 10/06→		für Linkslenker → 09/06		03.2125-0161.3 010920	ATE Ø 25,4
NISSAN - NAVARA NP300 Pritsche/Fahrgestell (D40) 07/08→							
 Hauptbremszylinder							
2.5 dCi 4WD	106	08/08→		01/10→; für Linkslenker		03.2125-0161.3 010920	ATE Ø 25,4
NISSAN - NOTE (E11, NE11) 01/05→08/13							
 Bremskraftverstärker							
1.4 1.4 LPG 1.5 1.5 dCi 1.6	65 65 80 50 - 76 81	03/06→06/12 01/06→08/13 03/06→12/10 03/06→06/12 03/06→06/12		für Linkslenker		03.7863-3002.4 300223	ATE Ø 10" pneumatisch
 Hauptbremszylinder							
1.4 1.4 LPG 1.5 1.5 dCi 1.6	65 65 80 50 - 76 81	03/06→06/12 01/06→08/13 03/06→12/10 03/06→06/12 03/06→06/12		+ ESP		03.2123-2923.3 010791	ATE Ø 23,8
NISSAN - NOTE VAN (E11) 01/05→08/13							
 Bremskraftverstärker							
1.5 dCi	63	01/11→09/12		für Linkslenker		03.7863-3002.4 300223	ATE Ø 10" pneumatisch
 Hauptbremszylinder							
1.5 dCi	63	01/11→09/12		+ ESP		03.2123-2923.3 010791	ATE Ø 23,8
NISSAN - NP300 PICKUP (D22) 04/08→							
 Hauptbremszylinder							
2.5 dCi 2.5 dCi 4x4	98 98	04/08→ 04/08→				03.2125-0161.3 010920	ATE Ø 25,4















	kw			 	! #		
NISSAN - PATHFINDER III (R51) 01/05→							
 Hauptbremszylinder							
2.5 dCi 2.5 dCi 4WD	128 126 - 128	01/05→01/10 01/05→		für Linkslenker		03.2125-0531.3 010945	ATE Ø 25,4
2.5 dCi 4WD 4.0 4.0 4WD	120 214 198	01/05→ 01/10→08/14 09/05→				03.2125-0531.3 010945	ATE Ø 25,4
2.5 dCi 4WD	140	08/10→				03.2125-0161.3 010920	ATE Ø 25,4
NISSAN - PATHFINDER III VAN (R51_) 01/05→08/14							
 Hauptbremszylinder							
2.5 dCi 4x4 3.0 dCi 4x4	140 170	03/13→08/14 03/13→08/14		für Linkslenker		03.2125-0161.3 010920	ATE Ø 25,4
NISSAN - PRIMASTAR Bus (X83) 03/01→							
 Hauptbremszylinder							
2.0	88	03/01→08/06		→ 01/03; - ABS		24.2120-1738.3 010759	TRW Ø 20,6
				02/03→; - ABS		24.2120-1740.3 010764	TRW Ø 20,6
				02/03→; + ABS		24.2125-1731.3 010826	TRW Ø 25,4
dCi 100 dCi 80	74 60	03/01→ 03/01→		→ 01/03; - ABS		24.2120-1738.3 010759	TRW Ø 20,6
				02/03→ 08/06; - ABS		24.2120-1740.3 010764	TRW Ø 20,6
				02/03→ 08/06; + ABS		24.2125-1731.3 010826	TRW Ø 25,4
dCi 115 dCi 120 dCi 150 dCi 90	84 84 107 66	09/08→ 09/06→ 09/06→ 09/06→		- ABS		24.2120-1740.3 010764	TRW Ø 20,6
				+ ABS		24.2125-1731.3 010826	TRW Ø 25,4
dCi 140	99	07/03→		→ 08/06; - ABS		24.2120-1740.3 010764	TRW Ø 20,6
				→ 08/06; + ABS		24.2125-1731.3 010826	TRW Ø 25,4
NISSAN - PRIMASTAR Kasten (X83) 09/02→							
 Hauptbremszylinder							
1.9 dCi 100 1.9 dCi 80	74 60	09/02→ 09/02→		→ 01/03; - ABS		24.2120-1738.3 010759	TRW Ø 20,6
				02/03→ 08/06; - ABS		24.2120-1740.3 010764	TRW Ø 20,6
				02/03→ 08/06; + ABS		24.2125-1731.3 010826	TRW Ø 25,4
2.0 2.0 dCi 115 2.0 dCi 90 2.5 dCi 115 2.5 dCi 150	88 84 66 84 107	02/03→ 09/06→ 09/06→ 09/08→ 09/06→		- ABS		24.2120-1740.3 010764	TRW Ø 20,6
				+ ABS		24.2125-1731.3 010826	TRW Ø 25,4
2.5 dCi 140	99	07/03→		→ 08/06; - ABS		24.2120-1740.3 010764	TRW Ø 20,6
				→ 08/06; + ABS		24.2125-1731.3 010826	TRW Ø 25,4
NISSAN - PRIMASTAR Pritsche/Fahrgestell (X83) 07/02→							
 Hauptbremszylinder							
1.9 dCi 100 1.9 dCi 80	74 60	07/02→08/06 07/02→08/06		→ 01/03; - ABS		24.2120-1738.3 010759	TRW Ø 20,6
				02/03→; - ABS		24.2120-1740.3 010764	TRW Ø 20,6
				02/03→; + ABS		24.2125-1731.3 010826	TRW Ø 25,4
2.0	88	07/02→08/06		→ 09/03; - ABS		24.2120-1738.3 010759	TRW Ø 20,6
				10/03→; - ABS		24.2125-1731.3 010826	TRW Ø 25,4
2.5 dCi 140	99	07/02→08/06		- ABS		24.2120-1740.3 010764	TRW Ø 20,6
				+ ABS		24.2125-1731.3 010826	TRW Ø 25,4
2.5 dCi 150	107	04/06→		09/06→; - ABS		24.2120-1740.3 010764	TRW Ø 20,6
				09/06→; + ABS		24.2125-1731.3 010826	TRW Ø 25,4
NISSAN - PRIMERA (P12) 01/02→							
 Hauptbremszylinder							
1.6 1.8 1.8 LPG 1.9 dCi 2.0 2.2 dCi	78 - 80 85 85 85 - 88 103 102	01/02→08/08 03/02→10/08 03/02→ 08/02→10/07 03/02→10/08 04/03→04/06		06/04→		24.2122-1774.3 010987	Ø 22,2 ohne Bremsflüssigkeitsbehälter













	kW					! #		
NISSAN - PRIMERA Hatchback (P12) 01/02→								
 Hauptbremszylinder								
1.6	78 - 80	07/02→08/08		06/04→		24.2122-1774.3	010987	Ø 22,2 ohne Bremsflüssigkeitsbehälter
1.8	85	07/02→10/08						
1.9 dCi	85 - 88	08/02→10/07						
2.0	103	07/02→10/08						
2.2 dCi	102	04/03→		06/04→ 10/07		24.2122-1774.3	010987	Ø 22,2 ohne Bremsflüssigkeitsbehälter
NISSAN - PRIMERA Kombi (WP12) 01/02→								
 Hauptbremszylinder								
1.6 Visia	80	01/02→04/06		06/04→		24.2122-1774.3	010987	Ø 22,2 ohne Bremsflüssigkeitsbehälter
1.8	85	03/02→05/07						
1.9 dCi	85	08/02→10/07						
1.9 dCi	88	04/03→		06/04→ 10/07		24.2122-1774.3	010987	Ø 22,2 ohne Bremsflüssigkeitsbehälter
2.2 dCi	102	04/03→						
2.0	103	03/02→		06/04→ 10/08		24.2122-1774.3	010987	Ø 22,2 ohne Bremsflüssigkeitsbehälter
NISSAN - PULSAR Schrägheck (C13) 10/14→								
 Hauptbremszylinder								
1.6 CVTC	86	08/12→		für Linkslenker; CVT-Automatikgetriebe (stufenlos)		24.4123-1727.3	011088	Ø 23,8 ohne Bremsflüssigkeitsbehälter
NISSAN - QASHQAI / QASHQAI +2 I (J10, NJ10, JJ10E) 11/06→04/14								
 Hauptbremszylinder								
1.5 dCi	76 - 81	11/06→12/13		+ ESP; für Linkslenker		24.4123-1725.3	011073	Ø 23,8 ohne Bremsflüssigkeitsbehälter
1.6	81 - 86	02/07→12/13		- ESP; für Linkslenker		24.4123-1729.3	011106	Ø 23,8 ohne Bremsflüssigkeitsbehälter
1.6 LPG	86	11/10→12/13						
2.0	102 - 104	02/07→12/13						
2.0 All-wheel Drive	102 - 104	02/07→12/13						
2.0 dCi	110	02/07→12/13						
2.0 dCi All-wheel Drive	110	02/07→12/13						
1.6	84	02/07→12/13		+ ESP; für Linkslenker; 01/10→		24.4123-1725.3	011073	Ø 23,8 ohne Bremsflüssigkeitsbehälter
				- ESP; für Linkslenker		24.4123-1729.3	011106	Ø 23,8 ohne Bremsflüssigkeitsbehälter
1.6 dCi	96	10/11→12/13		für Linkslenker		24.4123-1725.3	011073	Ø 23,8 ohne Bremsflüssigkeitsbehälter
1.6 dCi All-wheel Drive	96	10/11→12/13						
2.0	103	01/10→04/14		für Linkslenker; Schaltgetriebe; für Fahrzeuge mit Adaptive Cruise Control		24.4123-1725.3	011073	Ø 23,8 ohne Bremsflüssigkeitsbehälter
2.0 All-wheel Drive	103	01/10→04/14		für Linkslenker; Schaltgetriebe; für Fahrzeuge ohne Adaptive Cruise Control		24.4123-1729.3	011106	Ø 23,8 ohne Bremsflüssigkeitsbehälter
NISSAN - QASHQAI / QASHQAI +2 I VAN (J10, JJ10E) 12/06→04/14								
 Hauptbremszylinder								
1.5 dCi	81	03/13→04/14		+ ESP; für Linkslenker		24.4123-1725.3	011073	Ø 23,8 ohne Bremsflüssigkeitsbehälter
1.6 CVTC	86	03/13→04/14						
2.0	104	03/13→04/14		→ 01/14; - ESP; für Linkslenker		24.4123-1729.3	011106	Ø 23,8 ohne Bremsflüssigkeitsbehälter
2.0 All-wheel Drive	104	03/13→04/14						
2.0 dCi All-wheel Drive	110	03/13→04/14						
1.6 dCi	96	03/13→04/14		für Linkslenker		24.4123-1725.3	011073	Ø 23,8 ohne Bremsflüssigkeitsbehälter
1.6 dCi All-wheel Drive	96	03/13→04/14						
NISSAN - QASHQAI II SUV (J11, J11_) 11/13→								
 Hauptbremszylinder								
1.2 DIG-T	85	11/13→		02/14→; Schaltgetriebe 6 Gang		24.4123-1728.3	011089	Ø 23,8 ohne Bremsflüssigkeitsbehälter
1.6 dCi	96	11/13→						
1.3 DIG-T	103	08/18→				24.4123-1728.3	011089	Ø 23,8 ohne Bremsflüssigkeitsbehälter
1.6 DIG-T	120	10/14→						
1.7 dCi	110	01/19→						
1.3 DIG-T	118	08/18→		Schaltgetriebe 6 Gang		24.4123-1728.3	011089	Ø 23,8 ohne Bremsflüssigkeitsbehälter
1.5 dCi	85	06/18→						
1.7 dCi ALL MODE 4x4-i	110	01/19→						
2.0	103 - 106	06/14→						
1.5 dCi	81	11/13→		→ 01/14; + ESP; für Linkslenker		24.4123-1725.3	011073	Ø 23,8 ohne Bremsflüssigkeitsbehälter
→								











	kw					! #		
NISSAN - QASHQAI II SUV (J11, J11_) 11/13→								
 Hauptbremszylinder								
1.5 dCi	81	11/13→		02/14→		24.4123-1728.3	011089	Ø 23,8 ohne Bremsflüssigkeitsbehälter
				→ 01/14; - ESP; für Linkslenker		24.4123-1729.3	011106	Ø 23,8 ohne Bremsflüssigkeitsbehälter
1.6 dCi ALL MODE 4x4-i	96	11/13→		02/14→		24.4123-1728.3	011089	Ø 23,8 ohne Bremsflüssigkeitsbehälter
NISSAN - QASHQAI II VAN (J11_) 11/13→								
 Hauptbremszylinder								
1.5 dCi	81	05/15→				24.4123-1728.3	011089	Ø 23,8 ohne Bremsflüssigkeitsbehälter
1.5 dCi	85	06/18→		Schaltgetriebe 6 Gang		24.4123-1728.3	011089	Ø 23,8 ohne Bremsflüssigkeitsbehälter
NISSAN - SENTRA VII (B17) 08/12→								
 Hauptbremszylinder								
1.6 1.8	86 96	08/14→ 08/12→		für Linkslenker; CVT-Automatikgetriebe (stufenlos)		24.4123-1727.3	011088	Ø 23,8 ohne Bremsflüssigkeitsbehälter
NISSAN - TIIDA Schrägheck (C12) 08/10→								
 Hauptbremszylinder								
1.6 1.6 CVTC 1.8	85 - 140 80 96	08/12→ 01/14→ 08/12→		für Linkslenker; CVT-Automatikgetriebe (stufenlos)		24.4123-1727.3	011088	Ø 23,8 ohne Bremsflüssigkeitsbehälter
NISSAN - X-TRAIL I (T30) 01/01→12/13								
 Hauptbremszylinder								
2.0 2.0 4x4 2.5 4x4	103 - 110 103 - 206 121	07/01→01/13 06/01→01/13 09/02→01/13		→ 08/03; Schaltgetriebe; - ESP		24.2125-1741.3	010988	Ø 25,4 ohne Bremsflüssigkeitsbehälter
2.2 DCi FWD 2.2 Di 4x4 2.5 4x4	84 84 132	06/01→09/04 07/01→10/05 11/02→01/13		Schaltgetriebe; - ESP		24.2125-1741.3	010988	Ø 25,4 ohne Bremsflüssigkeitsbehälter
2.5 4x4	134	09/01→02/07		→ 09/03; für Linkslenker; Schaltgetriebe; - ESP		24.2125-1741.3	010988	Ø 25,4 ohne Bremsflüssigkeitsbehälter
NISSAN - X-TRAIL III (T32_, T32R, T32RR) 10/13→								
 Hauptbremszylinder								
1.6 dCi	96	04/14→		→ 10/16; für Linkslenker; Automatikgetriebe		24.4123-1728.3	011089	Ø 23,8 ohne Bremsflüssigkeitsbehälter
				für Linkslenker; Schaltgetriebe 6 Gang		24.4123-1728.3	011089	Ø 23,8 ohne Bremsflüssigkeitsbehälter
1.6 dCi ALL MODE 4x4-i	96	04/14→		→ 08/16; für Linkslenker; für Modellreihenbaumuster: T32R/T32RR		24.4123-1728.3	011089	Ø 23,8 ohne Bremsflüssigkeitsbehälter
1.6 DIG-T	120	06/15→				24.4123-1728.3	011089	Ø 23,8 ohne Bremsflüssigkeitsbehälter
2.0 2.0 Flexfuel 2.0 Flexfuel ALL MODE 4x4-i 2.5 ALL MODE 4x4-i 2.5 Flexfuel ALL MODE 4x4-i	104 - 108 106 106 124 126	12/13→ 09/14→ 02/14→ 10/14→ 02/14→		12/14→; für Linkslenker; Schaltgetriebe		24.4123-1728.3	011089	Ø 23,8 ohne Bremsflüssigkeitsbehälter
2.0 dCi ALL MODE 4x4-i	130	10/16→		für Linkslenker; Schaltgetriebe 6 Gang		24.4123-1728.3	011089	Ø 23,8 ohne Bremsflüssigkeitsbehälter
2.5	124	01/15→		für Linkslenker; Schaltgetriebe		24.4123-1728.3	011089	Ø 23,8 ohne Bremsflüssigkeitsbehälter
NISSAN - X-TRAIL VAN (T32) 10/13→								
 Hauptbremszylinder								
dCi	96	04/14→		→ 10/16; für Linkslenker; Automatikgetriebe		24.4123-1728.3	011089	Ø 23,8 ohne Bremsflüssigkeitsbehälter
				für Linkslenker; Schaltgetriebe 6 Gang		24.4123-1728.3	011089	Ø 23,8 ohne Bremsflüssigkeitsbehälter
dCi 4x4	96	04/14→		→ 08/16; für Linkslenker; für Modellreihenbaumuster: T32R/T32RR		24.4123-1728.3	011089	Ø 23,8 ohne Bremsflüssigkeitsbehälter













	kw			 	! #		
OPEL - ADAM (M13) 10/12→02/19							
 Hauptbremszylinder							
1.0	66 - 85	07/14→11/18		für Linkslenker; Trommelbremse		24.4122-1731.3 011100	Ø 22,2 ohne Bremsflüssigkeitsbehälter
1.4 LPG 1.4 S	64 110	07/13→11/18 11/14→01/19		für Rechtslenker		24.4122-1737.3 011147	BOS Ø 22,2 ohne Bremsflüssigkeitsbehälter
				für Linkslenker; Scheibenbremse		24.4123-1722.3 011071	Ø 23,8 ohne Bremsflüssigkeitsbehälter
1.2 1.4	51 64 - 74	10/12→02/19 10/12→02/19		für Linkslenker; Trommelbremse		24.4122-1731.3 011100	Ø 22,2 ohne Bremsflüssigkeitsbehälter
				01/13→; für Rechtslenker		24.4122-1737.3 011147	BOS Ø 22,2 ohne Bremsflüssigkeitsbehälter
				01/13→; für Linkslenker; Scheibenbremse		24.4123-1722.3 011071	Ø 23,8 ohne Bremsflüssigkeitsbehälter
OPEL - AGILA (A) (H00) 09/00→12/07							
 Hauptbremszylinder							
1.0 1.0 12V 1.2 16V 1.3 CDTI	44 43 55 51	08/03→12/07 09/00→12/07 09/00→12/07 08/03→12/07		+ ABS; → 07/07		24.2120-1730.3 010678	Ø 20,6
OPEL - AGILA (B) (H08) 04/08→10/14							
 Hauptbremszylinder							
1.0 1.0 LPG 1.2 1.2 LPG 1.3 CDTI	48 - 50 48 63 - 69 63 55	04/08→07/14 01/10→06/11 04/08→10/14 04/08→10/10 04/08→04/10		für Linkslenker; - ESP		24.4122-1718.3 011019	BOS Ø 22,2 ohne Bremsflüssigkeitsbehälter
				für Linkslenker; + ESP		24.4122-1719.3 011020	Ø 22,2 ohne Bremsflüssigkeitsbehälter
OPEL - ASTRA F Cabriolet (T92) 03/93→03/01							
 Hauptbremszylinder							
1.4 i 16V 1.4 Si	66 60	01/96→03/01 05/93→03/01		→ 09/98; - ABS; für Fahrzeuge mit verstärkter Bremse		03.2122-0264.3 010129	ATE Ø 22,2
				→ 09/98; - ABS; nicht für Fahrzeuge mit verstärkter Bremse		24.2120-0702.3 010361	nicht für Delco Ø 20,6
1.8 i 16V	85	11/94→03/01		→ 09/98; - ABS		03.2122-0264.3 010129	ATE Ø 22,2
 Bremskraftregler							
1.6 i	55	01/96→03/01		→ R2500000		03.0101-0027.2 320022	ATE Satz 3/45 2x
OPEL - ASTRA F CLASSIC Caravan (T92) 01/98→01/05							
 Hauptbremszylinder							
1.4 i 1.6 i	44 55	01/98→01/05 01/98→01/05				24.2120-0702.3 010361	nicht für Delco Ø 20,6
OPEL - ASTRA F CLASSIC CC (T92) 01/98→08/02							
 Hauptbremszylinder							
1.4 i 1.6 i	44 55	01/98→08/02 01/98→08/02		- ABS		24.2120-0702.3 010361	nicht für Delco Ø 20,6
 Bremskraftregler							
1.6 i 16V	74	01/98→08/02				03.6583-0054.3 320146	ATE lastabhängig 8/3 4x
OPEL - ASTRA F CLASSIC Stufenheck (T92) 01/98→08/02							
 Hauptbremszylinder							
1.4 i 1.6 i	44 55	01/98→08/02 01/98→08/02		- ABS		24.2120-0702.3 010361	nicht für Delco Ø 20,6
 Bremskraftregler							
1.6 i 16V	74	01/98→08/02				03.6583-0054.3 320146	ATE lastabhängig 8/3 4x
OPEL - ASTRA G Cabriolet (T98) 03/01→10/05							
 Hauptbremszylinder							
1.6 1.6 16V 1.8 16V 2.0 16V Turbo 2.0 OPC →	76 74 92 147 141	01/03→10/05 03/01→10/05 03/01→10/05 11/02→10/05 03/02→10/05		- ESP		24.2123-1734.3 010640	TRW Ø 23,8
				+ ESP		24.2123-1739.3 010661	Ø 23,8











	kw					! #		
OPEL - ASTRA G Cabriolet (T98) 03/01→10/05								
 Hauptbremszylinder								
2.2 16V	108	03/01→10/05		- ESP		24.2123-1734.3	010640	TRW Ø 23,8
				+ ESP		24.2123-1739.3	010661	Ø 23,8
2.2 DTI	92	09/02→10/05		- ESP		24.2123-1734.3	010640	TRW Ø 23,8
OPEL - ASTRA G Caravan (T98) 02/98→07/05								
 Hauptbremszylinder								
1.2 16V	48	02/98→09/00		04/98→; - ESP; für Fahrzeuge mit Scheibenbremse an der Hinterachse		24.2123-1734.3	010640	TRW Ø 23,8
1.6	55	02/98→09/00						
1.6 16V	74	02/98→07/04		22000001→; - ESP; für Fahrzeuge mit Trommelbremse an der Hinterachse		24.2123-1734.3	010640	TRW Ø 23,8
				04/98→; + ESP		24.2123-1739.3	010661	Ø 23,8
1.2 16V	55	09/00→07/04		- ESP; für Fahrzeuge mit Scheibenbremse an der Hinterachse		24.2123-1734.3	010640	TRW Ø 23,8
1.4 16V	66	06/98→07/04						
1.4 LPG	66	03/98→07/04		22000001→; - ESP; für Fahrzeuge mit Trommelbremse an der Hinterachse		24.2123-1734.3	010640	TRW Ø 23,8
1.6	62 - 76	09/00→07/04						
1.6 LPG	74 - 76	03/98→07/04		+ ESP		24.2123-1739.3	010661	Ø 23,8
1.7 DTI 16V	55	02/00→07/04						
1.6 CNG	71	03/03→07/04		- ESP		24.2123-1734.3	010640	TRW Ø 23,8
1.8 16V	92	09/00→07/04						
2.0 DTI 16V	74	08/99→07/04		+ ESP		24.2123-1739.3	010661	Ø 23,8
2.0 OPC	141 - 147	09/02→07/04						
2.2 16V	108	03/01→07/04						
2.2 DTI	86 - 92	09/02→07/04						
1.7 CDTI	59	04/03→05/04		- ESP		24.2123-1734.3	010640	TRW Ø 23,8
1.7 TD	50	02/98→08/00		04/98→; - ESP; für Fahrzeuge mit Scheibenbremse an der Hinterachse		24.2123-1734.3	010640	TRW Ø 23,8
				04/98→; + ESP		24.2123-1739.3	010661	Ø 23,8
1.8 16V	85	02/98→09/00		04/98→; - ESP		24.2123-1734.3	010640	TRW Ø 23,8
2.0 16V	100	02/98→07/04						
2.0 DI	60	02/98→07/04		04/98→; + ESP		24.2123-1739.3	010661	Ø 23,8
 Bremskraftregler								
1.2 16V	48	02/98→09/00		04/98→; - ABS		03.6583-0073.3	320234	ATE lastabhängig 8/3 4x
1.6	55	02/98→09/00						
1.6 16V	74	02/98→07/04						
1.7 TD	50	02/98→08/00						
1.8 16V	85	02/98→09/00						
2.0 16V	100	02/98→07/04						
1.2 16V	55	09/00→07/04		- ABS		03.6583-0073.3	320234	ATE lastabhängig 8/3 4x
1.4 16V	66	06/98→07/04						
1.4 LPG	66	03/98→07/04						
1.6	62 - 76	09/00→07/04						
1.6 CNG	71	03/03→07/04						
1.6 LPG	74 - 76	03/98→07/04						
1.7 CDTI	59	04/03→05/04						
1.7 DTI 16V	55	02/00→07/04						
1.8 16V	92	09/00→07/04						
OPEL - ASTRA G CC (T98) 02/98→12/09								
 Hauptbremszylinder								
1.2 16V	48	02/98→09/00		04/98→; - ESP; für Fahrzeuge mit Scheibenbremse an der Hinterachse		24.2123-1734.3	010640	TRW Ø 23,8
1.4 16V	66	02/98→01/05						
1.4 LPG	66	02/98→01/05		22000001→; - ESP; für Fahrzeuge mit Trommelbremse an der Hinterachse		24.2123-1734.3	010640	TRW Ø 23,8
1.6	55	02/98→09/00						
1.6 16V	74	02/98→01/05		04/98→; + ESP		24.2123-1739.3	010661	Ø 23,8
1.6 LPG	74	03/98→01/05						
1.2 16V	55	09/00→01/05		- ESP; für Fahrzeuge mit Scheibenbremse an der Hinterachse		24.2123-1734.3	010640	TRW Ø 23,8
1.4	66	09/07→12/09						
1.6	62 - 76	09/00→01/05		22000001→; - ESP; für Fahrzeuge mit Trommelbremse an der Hinterachse		24.2123-1734.3	010640	TRW Ø 23,8
1.6 LPG	76	11/02→06/07						
1.7 DTI 16V	55	02/00→01/05		+ ESP		24.2123-1739.3	010661	Ø 23,8
1.7 CDTI	59	04/03→01/05		- ESP		24.2123-1734.3	010640	TRW Ø 23,8
1.7 TD	50	02/98→08/00		04/98→; - ESP; für Fahrzeuge mit Scheibenbremse an der Hinterachse		24.2123-1734.3	010640	TRW Ø 23,8
				04/98→; + ESP		24.2123-1739.3	010661	Ø 23,8
1.8	81	02/03→01/04		- ESP		24.2123-1734.3	010640	TRW Ø 23,8
1.8 16V	92	09/00→01/05						
2.0 16V OPC	118	11/99→09/02		+ ESP		24.2123-1739.3	010661	Ø 23,8
2.0 DTI 16V	74	08/99→01/05						











	kw					! #		
OPEL - ASTRA G CC (T98) 02/98→12/09								
 Hauptbremszylinder								
2.0 OPC	141	09/02→01/05		- ESP		24.2123-1734.3	010640	TRW Ø 23,8
2.2 DTI	147 86 - 92	09/02→01/05		+ ESP		24.2123-1739.3	010661	Ø 23,8
1.8 16V	85	02/98→09/00		04/98→; - ESP		24.2123-1734.3	010640	TRW Ø 23,8
2.0 16V	100	02/98→01/05		04/98→; + ESP		24.2123-1739.3	010661	Ø 23,8
2.0 DI	60	02/98→01/05						
2.2 16V	108	06/00→01/05		09/00→; - ESP		24.2123-1734.3	010640	TRW Ø 23,8
				09/00→; + ESP		24.2123-1739.3	010661	Ø 23,8
 Bremskraftregler								
1.2 16V	48	02/98→09/00		04/98→; - ABS		03.6583-0073.3	320234	ATE lastabhängig 8/3 4x
1.2 16V	55	09/00→01/05		- ABS		03.6583-0073.3	320234	ATE lastabhängig 8/3 4x
OPEL - ASTRA G CLASSIC (T98) 03/04→07/09								
 Hauptbremszylinder								
1.4 16V	66	05/04→07/09		- ESP; für Fahrzeuge mit Scheibenbremse an der Hinterachse		24.2123-1734.3	010640	TRW Ø 23,8
1.6	76	03/06→06/08						
1.6 16V	74	05/04→02/06		22000001→; - ESP; für Fahrzeuge mit Trommelbremse an der Hinterachse		24.2123-1734.3	010640	TRW Ø 23,8
				+ ESP		24.2123-1739.3	010661	Ø 23,8
1.7 CDTI	59	06/04→07/09		- ESP		24.2123-1734.3	010640	TRW Ø 23,8
OPEL - ASTRA G CLASSIC Caravan (F35) 03/04→07/09								
 Hauptbremszylinder								
1.4	66	10/07→07/09		- ESP		24.2123-1734.3	010640	TRW Ø 23,8
1.4 16V	66	07/04→09/07		+ ESP		24.2123-1739.3	010661	Ø 23,8
1.6	74 - 76	06/04→07/09		- ESP; für Fahrzeuge mit Scheibenbremse an der Hinterachse		24.2123-1734.3	010640	TRW Ø 23,8
				22000001→; - ESP; für Fahrzeuge mit Trommelbremse an der Hinterachse		24.2123-1734.3	010640	TRW Ø 23,8
				+ ESP		24.2123-1739.3	010661	Ø 23,8
1.7 CDTI	59	05/04→07/09		- ESP		24.2123-1734.3	010640	TRW Ø 23,8
 Bremskraftregler								
1.4	66	10/07→07/09		- ABS		03.6583-0073.3	320234	ATE lastabhängig 8/3 4x
1.4 16V	66	07/04→09/07						
1.6	74 - 76	06/04→07/09						
1.7 CDTI	59	05/04→07/09						
OPEL - ASTRA G CLASSIC Stufenheck (T98) 03/04→07/09								
 Hauptbremszylinder								
1.4 16V	66	05/04→07/09		- ESP		24.2123-1734.3	010640	TRW Ø 23,8
				+ ESP		24.2123-1739.3	010661	Ø 23,8
1.6 16V	74	03/04→01/08		- ESP; für Fahrzeuge mit Scheibenbremse an der Hinterachse		24.2123-1734.3	010640	TRW Ø 23,8
				22000001→; - ESP; für Fahrzeuge mit Trommelbremse an der Hinterachse		24.2123-1734.3	010640	TRW Ø 23,8
				+ ESP		24.2123-1739.3	010661	Ø 23,8
OPEL - ASTRA G Coupe (T98) 03/00→06/06								
 Hauptbremszylinder								
1.6 16V	74 - 76	03/00→05/05		- ESP; für Fahrzeuge mit Scheibenbremse an der Hinterachse		24.2123-1734.3	010640	TRW Ø 23,8
				22000001→; - ESP; für Fahrzeuge mit Trommelbremse an der Hinterachse		24.2123-1734.3	010640	TRW Ø 23,8
				+ ESP		24.2123-1739.3	010661	Ø 23,8
1.8 16V	85 - 92	03/00→05/05		- ESP		24.2123-1734.3	010640	TRW Ø 23,8
2.0 16V Turbo	140 - 147	09/00→05/05		+ ESP		24.2123-1739.3	010661	Ø 23,8
2.2 16V	108	09/00→05/05						
2.2 DTI	92	09/02→05/05						











	kw					! #		
OPEL - ASTRA G Kasten/Kombi (F70) 09/98→04/05								
 Hauptbremszylinder								
1.2 1.4 1.6	48 66 55 - 76	09/98→08/00 09/98→04/05 09/98→04/05		- ESP; für Fahrzeuge mit Scheibenbremse an der Hinterachse		24.2123-1734.3	010640	TRW Ø 23,8
1.7 CDTi 1.7 DTI 16V	59 55	07/03→11/04 02/00→04/05		22000001→; - ESP; für Fahrzeuge mit Trommelbremse an der Hinterachse + ESP		24.2123-1734.3	010640	TRW Ø 23,8
1.7 TD	50	01/99→04/05		- ESP; für Fahrzeuge mit Scheibenbremse an der Hinterachse + ESP		24.2123-1734.3	010640	TRW Ø 23,8
2.0 DI 2.0 DTI	60 74	01/99→04/05 09/00→04/05		- ESP + ESP		24.2123-1734.3	010640	TRW Ø 23,8
 Bremskraftregler								
1.2 1.4 1.6 1.7 TD	48 66 55 - 76 50	09/98→08/00 09/98→04/05 09/98→04/05 01/99→04/05		- ABS		03.6583-0073.3	320234	ATE lastabhängig 8/3 4x
OPEL - ASTRA G Stufenheck (T98) 03/98→12/09								
 Hauptbremszylinder								
1.2 16V 1.4 16V 1.4 LPG 1.6 1.6 16V 1.6 LPG 1.7 DTI 16V	48 - 55 66 66 55 - 76 74 55 - 74 55	09/98→01/05 09/98→01/05 03/98→01/05 09/98→12/09 09/98→01/05 10/98→01/05 02/00→01/05		- ESP; für Fahrzeuge mit Scheibenbremse an der Hinterachse 22000001→; - ESP; für Fahrzeuge mit Trommelbremse an der Hinterachse + ESP		24.2123-1734.3	010640	TRW Ø 23,8
1.4 1.8 16V 2.0 16V 2.0 DI 2.0 DTI 16V 2.2 16V 2.2 DTI	66 85 - 92 100 60 74 108 86 - 92	09/07→12/09 09/98→01/05 09/98→01/05 09/98→01/05 08/99→01/05 03/01→01/05 09/02→01/05		- ESP + ESP		24.2123-1734.3	010640	TRW Ø 23,8
1.7 CDTi 1.7 TD	59 50	04/03→12/09 09/98→08/00		- ESP - ESP; für Fahrzeuge mit Scheibenbremse an der Hinterachse + ESP		24.2123-1734.3	010640	TRW Ø 23,8
 Bremskraftregler								
1.2 16V	48 - 55	09/98→01/05		- ABS		03.6583-0073.3	320234	ATE lastabhängig 8/3 4x
OPEL - ASTRA H (A04) 01/04→05/14								
 Bremskraftverstärker								
1.9 CDTi 1.9 CDTi 1.9 CDTi 16V	74 - 110 88 88	09/04→10/10 06/04→10/10 04/04→10/10		für Linkslenker 09/04→; für Linkslenker		03.7863-7803.4	300237	ATE Ø 10" pneumatisch
 Hauptbremszylinder								
1.2 1.3 CDTi 1.4	59 66 55 - 66	08/05→10/10 08/05→10/10 03/04→10/10		für Rechtslenker; → 68999999 für Linkslenker; → 68999999; + ESP für Linkslenker; → 68999999; - ESP		24.2125-1736.3	010904	TRW Ø 25,4
1.4 LPG 1.6 1.6 Turbo 1.7 CDTi	66 77 132 59 - 74	08/09→10/10 03/04→10/10 02/07→10/10 03/04→10/10		72000001→; für Rechtslenker 72000001→; für Linkslenker; + ESP 72000001→; für Linkslenker; - ESP		24.4125-1703.3	010907	TRW Ø 25,4
1.8 2.0 Turbo	92 - 103 125 - 177	01/04→10/10 03/04→10/10						
1.6	85	12/06→05/14		01/07→; → 68999999; für Rechtslenker 01/07→; → 68999999; für Linkslenker; + ESP 01/07→; → 68999999; für Linkslenker; - ESP		24.2125-1736.3	010904	TRW Ø 25,4
→								















	kw			 	! #		
OPEL - ASTRA H (A04) 01/04→05/14							
 Hauptbremszylinder							
1.6	85	12/06→05/14		72000001→; → 11/10; für Rechtslenker		24.4125-1703.3 010907	TRW Ø 25,4
				72000001→; → 11/10; für Linkslenker; + ESP		24.4125-1703.3 010907	TRW Ø 25,4
				72000001→; → 11/10; für Linkslenker; - ESP		24.4125-1704.3 010908	TRW Ø 25,4
1.7 CDTI	81 - 92	02/07→05/14		04/07→; → 68999999; für Rechtslenker		24.2125-1736.3 010904	TRW Ø 25,4
				04/07→; → 68999999; für Linkslenker; + ESP		24.2125-1736.3 010904	TRW Ø 25,4
				04/07→; → 68999999; für Linkslenker; - ESP		24.2125-1737.3 010906	TRW Ø 25,4
				72000001→; → 11/10; für Rechtslenker		24.4125-1703.3 010907	TRW Ø 25,4
				72000001→; → 11/10; für Linkslenker; + ESP		24.4125-1703.3 010907	TRW Ø 25,4
				72000001→; → 11/10; für Linkslenker; - ESP		24.4125-1704.3 010908	TRW Ø 25,4
1.9 CDTI	74 - 110	09/04→10/10				03.4155-0156.3 010862	ATE Ø 25,4
1.9 CDTI	88	06/04→10/10		09/04→		03.4155-0156.3 010862	ATE Ø 25,4
1.9 CDTI 16V	88	04/04→10/10					
OPEL - ASTRA H Caravan (A04) 08/04→05/14							
 Bremskraftverstärker							
1.9 CDTI	74 - 110	09/04→10/10		für Linkslenker		03.7863-7803.4 300237	ATE Ø 10" pneumatisch
1.9 CDTI 16V	88	08/04→10/10					
 Hauptbremszylinder							
1.3 CDTI	66	08/05→10/10		72000001→; für Linkslenker; + ESP		24.2125-1703.3 010483	Ø 25,4
1.4	55 - 66	08/04→10/10		72000001→; für Linkslenker; - ESP		24.2125-1704.3 010446	TRW Ø 25,4
1.4 LPG	66	08/09→10/10		→ 62999999; für Rechtslenker		24.2125-1736.3 010904	TRW Ø 25,4
1.6	77	08/04→10/10		→ 68999999; für Linkslenker; + ESP		24.2125-1736.3 010904	TRW Ø 25,4
1.6 LPG	85	08/09→10/10		→ 68999999; für Linkslenker; - ESP		24.2125-1737.3 010906	TRW Ø 25,4
1.6 Turbo	132	02/07→10/10					
1.7 CDTI	59 - 74	08/04→10/10		72000001→; für Rechtslenker		24.4125-1703.3 010907	TRW Ø 25,4
1.8	92 - 103	08/04→05/14					
2.0 Turbo	125 - 147	08/04→10/10					
1.6	85	12/06→05/14		72000001→; → 11/10; für Linkslenker; + ESP		24.2125-1703.3 010483	Ø 25,4
				72000001→; → 11/10; für Linkslenker; - ESP		24.2125-1704.3 010446	TRW Ø 25,4
				01/07→; → 62999999; für Rechtslenker		24.2125-1736.3 010904	TRW Ø 25,4
				01/07→; → 68999999; für Linkslenker; + ESP		24.2125-1736.3 010904	TRW Ø 25,4
				01/07→; → 68999999; für Linkslenker; - ESP		24.2125-1737.3 010906	TRW Ø 25,4
				72000001→; → 11/10; für Rechtslenker		24.4125-1703.3 010907	TRW Ø 25,4
1.7 CDTI	81 - 92	02/07→05/14		72000001→; → 11/10; für Linkslenker; + ESP		24.2125-1703.3 010483	Ø 25,4
				72000001→; → 11/10; für Linkslenker; - ESP		24.2125-1704.3 010446	TRW Ø 25,4
				04/07→; → 62999999; für Rechtslenker		24.2125-1736.3 010904	TRW Ø 25,4
				04/07→; → 68999999; für Linkslenker; + ESP		24.2125-1736.3 010904	TRW Ø 25,4
				04/07→; → 68999999; für Linkslenker; - ESP		24.2125-1737.3 010906	TRW Ø 25,4
				72000001→; → 11/10; für Rechtslenker		24.4125-1703.3 010907	TRW Ø 25,4
1.9 CDTI	74 - 110	09/04→10/10				03.4155-0156.3 010862	ATE Ø 25,4
1.9 CDTI 16V	88	08/04→10/10					
OPEL - ASTRA H CLASSIC Kombi (A04) 12/06→							
 Hauptbremszylinder							
1.4	66	01/09→		72000001→; für Linkslenker; + ESP		24.2125-1703.3 010483	Ø 25,4
1.7 CDTI	81	01/09→		72000001→; für Linkslenker; - ESP		24.2125-1704.3 010446	TRW Ø 25,4
1.7 CDTI	92	01/09→					
1.8	103	01/12→05/14		→ 62999999; für Rechtslenker		24.2125-1736.3 010904	TRW Ø 25,4
				→ 68999999; für Linkslenker; + ESP		24.2125-1736.3 010904	TRW Ø 25,4
				→ 68999999; für Linkslenker; - ESP		24.2125-1737.3 010906	TRW Ø 25,4
				72000001→; für Rechtslenker		24.4125-1703.3 010907	TRW Ø 25,4
→							















	kw					! #		
OPEL - ASTRA H CLASSIC Kombi (A04) 12/06→								
 Hauptbremszylinder								
1.6	85	12/06→05/14		72000001→; → 11/10; für Linkslenker; + ESP		24.2125-1703.3	010483	Ø 25,4
				72000001→; → 11/10; für Linkslenker; - ESP		24.2125-1704.3	010446	TRW Ø 25,4
				01/07→; → 62999999; für Rechtslenker		24.2125-1736.3	010904	TRW Ø 25,4
				01/07→; → 68999999; für Linkslenker; + ESP		24.2125-1736.3	010904	TRW Ø 25,4
				01/07→; → 68999999; für Linkslenker; - ESP		24.2125-1737.3	010906	TRW Ø 25,4
				72000001→; → 11/10; für Rechtslenker		24.4125-1703.3	010907	TRW Ø 25,4
OPEL - ASTRA H CLASSIC Schrägheck (A04) 01/09→								
 Hauptbremszylinder								
1.3 CDTi	66	01/09→		für Rechtslenker; → 68999999		24.2125-1736.3	010904	TRW Ø 25,4
1.6	85	01/09→		für Linkslenker; → 68999999; + ESP		24.2125-1736.3	010904	TRW Ø 25,4
1.7 CDTi	81	01/09→		für Linkslenker; → 68999999; - ESP		24.2125-1737.3	010906	TRW Ø 25,4
				72000001→; → 11/10; für Rechtslenker		24.4125-1703.3	010907	TRW Ø 25,4
				72000001→; → 11/10; für Linkslenker; + ESP		24.4125-1703.3	010907	TRW Ø 25,4
				72000001→; → 11/10; für Linkslenker; - ESP		24.4125-1704.3	010908	TRW Ø 25,4
1.4	66	01/09→		für Rechtslenker; → 68999999		24.2125-1736.3	010904	TRW Ø 25,4
1.7 CDTi	92	01/09→		für Linkslenker; → 68999999; + ESP		24.2125-1736.3	010904	TRW Ø 25,4
1.8	103	02/13→		für Linkslenker; → 68999999; - ESP		24.2125-1737.3	010906	TRW Ø 25,4
				72000001→; für Rechtslenker		24.4125-1703.3	010907	TRW Ø 25,4
				72000001→; für Linkslenker; + ESP		24.4125-1703.3	010907	TRW Ø 25,4
				72000001→; für Linkslenker; - ESP		24.4125-1704.3	010908	TRW Ø 25,4
OPEL - ASTRA H CLASSIC Stufenheck (A04) 02/07→								
 Hauptbremszylinder								
1.6	85	01/09→05/14		→ 68999999; für Rechtslenker		24.2125-1736.3	010904	TRW Ø 25,4
				→ 68999999; für Linkslenker; + ESP		24.2125-1736.3	010904	TRW Ø 25,4
				→ 68999999; für Linkslenker; - ESP		24.2125-1737.3	010906	TRW Ø 25,4
				72000001→; → 11/10; für Rechtslenker		24.4125-1703.3	010907	TRW Ø 25,4
				72000001→; für Linkslenker; + ESP		24.4125-1703.3	010907	TRW Ø 25,4
				72000001→; für Linkslenker; - ESP		24.4125-1704.3	010908	TRW Ø 25,4
1.7 CDTi	81	01/09→		→ 68999999; für Rechtslenker		24.2125-1736.3	010904	TRW Ø 25,4
1.7 CDTi	92	01/09→		→ 68999999; für Linkslenker; + ESP		24.2125-1736.3	010904	TRW Ø 25,4
1.8	103	02/07→09/12		→ 68999999; für Linkslenker; - ESP		24.2125-1737.3	010906	TRW Ø 25,4
				72000001→; für Rechtslenker		24.4125-1703.3	010907	TRW Ø 25,4
				72000001→; für Linkslenker; + ESP		24.4125-1703.3	010907	TRW Ø 25,4
				72000001→; für Linkslenker; - ESP		24.4125-1704.3	010908	TRW Ø 25,4
OPEL - ASTRA H GTC (A04) 03/05→10/10								
 Bremskraftverstärker								
1.9 CDTi	110	03/05→10/10		für Linkslenker		03.7863-7803.4	300237	ATE Ø 10" pneumatisch
1.9 CDTi	74	09/05→10/10						
	88							
1.9 CDTi 16V	88	03/05→10/10						
 Hauptbremszylinder								
1.3 CDTi	66	04/05→10/10		08/05→; → 68999999; für Linkslenker; + ESP		24.2125-1736.3	010904	TRW Ø 25,4
				08/05→; → 68999999; für Rechtslenker		24.2125-1736.3	010904	TRW Ø 25,4
				08/05→; → 68999999; für Linkslenker; - ESP		24.2125-1737.3	010906	TRW Ø 25,4
				72000001→; für Rechtslenker		24.4125-1703.3	010907	TRW Ø 25,4
				72000001→; für Linkslenker; + ESP		24.4125-1703.3	010907	TRW Ø 25,4
				72000001→; für Linkslenker; - ESP		24.4125-1704.3	010908	TRW Ø 25,4
1.4	55 - 66	03/05→10/10		für Rechtslenker; → 68999999		24.2125-1736.3	010904	TRW Ø 25,4
1.6	77	03/05→10/10		für Linkslenker; → 68999999; + ESP		24.2125-1736.3	010904	TRW Ø 25,4
1.6 Turbo	132	02/07→10/10		für Linkslenker; → 68999999; - ESP		24.2125-1737.3	010906	TRW Ø 25,4
1.7 CDTi	74	03/05→10/10		72000001→; für Rechtslenker		24.4125-1703.3	010907	TRW Ø 25,4
1.7 CDTi	59	03/05→10/10		72000001→; für Linkslenker; + ESP		24.4125-1703.3	010907	TRW Ø 25,4
1.8	92 - 103	03/05→10/10		72000001→; für Linkslenker; - ESP		24.4125-1704.3	010908	TRW Ø 25,4













	kw			 	! #		
OPEL - ASTRA H GTC (A04) 03/05→10/10							
 Hauptbremszylinder							
2.0 Turbo	125 - 177	03/05→10/10		für Rechtslenker; → 68999999	24.2125-1736.3	010904	TRW Ø 25,4
				für Linkslenker; → 68999999; + ESP	24.2125-1736.3	010904	TRW Ø 25,4
				für Linkslenker; → 68999999; - ESP	24.2125-1737.3	010906	TRW Ø 25,4
				72000001→; für Rechtslenker	24.4125-1703.3	010907	TRW Ø 25,4
				72000001→; für Linkslenker; + ESP	24.4125-1703.3	010907	TRW Ø 25,4
				72000001→; für Linkslenker; - ESP	24.4125-1704.3	010908	TRW Ø 25,4
1.6	85	12/06→10/10		01/07→; → 68999999; für Linkslenker; + ESP	24.2125-1736.3	010904	TRW Ø 25,4
				01/07→; → 68999999; für Rechtslenker	24.2125-1736.3	010904	TRW Ø 25,4
				01/07→; → 68999999; für Linkslenker; - ESP	24.2125-1737.3	010906	TRW Ø 25,4
				72000001→; für Rechtslenker	24.4125-1703.3	010907	TRW Ø 25,4
				72000001→; für Linkslenker; + ESP	24.4125-1703.3	010907	TRW Ø 25,4
				72000001→; für Linkslenker; - ESP	24.4125-1704.3	010908	TRW Ø 25,4
1.7 CDTi	81 - 92	02/07→10/10		04/07→; → 68999999; für Linkslenker; + ESP	24.2125-1736.3	010904	TRW Ø 25,4
				04/07→; → 68999999; für Rechtslenker	24.2125-1736.3	010904	TRW Ø 25,4
				04/07→; → 68999999; für Linkslenker; - ESP	24.2125-1737.3	010906	TRW Ø 25,4
				72000001→; für Rechtslenker	24.4125-1703.3	010907	TRW Ø 25,4
				72000001→; für Linkslenker; + ESP	24.4125-1703.3	010907	TRW Ø 25,4
				72000001→; für Linkslenker; - ESP	24.4125-1704.3	010908	TRW Ø 25,4
1.9 CDTi	110	03/05→10/10			03.4155-0156.3	010862	ATE Ø 25,4
1.9 CDTi	74 - 88	09/05→10/10					
1.9 CDTi 16V	88	03/05→10/10					
OPEL - ASTRA H Kasten/Kombi (L70) 02/04→10/14							
 Bremskraftverstärker							
1.9 CDTi	74 - 110	09/04→12/12		für Linkslenker	03.7863-7803.4	300237	ATE Ø 10" pneumatisch
1.9 CDTi 16V	88	08/04→10/10					
 Hauptbremszylinder							
1.3 CDTi 1.6 EcoTec	66 - 76 - 85	08/05→10/10 02/04→12/10		72000001→; für Linkslenker; + ESP	24.2125-1703.3	010483	Ø 25,4
				72000001→; für Linkslenker; - ESP	24.2125-1704.3	010446	TRW Ø 25,4
				→ 62999999; für Rechtslenker	24.2125-1736.3	010904	TRW Ø 25,4
				→ 68999999; für Linkslenker; + ESP	24.2125-1736.3	010904	TRW Ø 25,4
				→ 68999999; für Linkslenker; - ESP	24.2125-1737.3	010906	TRW Ø 25,4
				72000001→; für Rechtslenker	24.4125-1703.3	010907	TRW Ø 25,4
1.4 EcoTec 1.7 CDTi	66 - 59	12/04→12/12 12/04→07/07		für Rechtslenker; → 68999999	24.2125-1736.3	010904	TRW Ø 25,4
				→ 68999999; für Linkslenker; + ESP	24.2125-1736.3	010904	TRW Ø 25,4
				→ 68999999; für Linkslenker; - ESP	24.2125-1737.3	010906	TRW Ø 25,4
				72000001→; für Rechtslenker	24.4125-1703.3	010907	TRW Ø 25,4
				72000001→; für Linkslenker; + ESP	24.4125-1703.3	010907	TRW Ø 25,4
				72000001→; für Linkslenker; - ESP	24.4125-1704.3	010908	TRW Ø 25,4
1.7 CDTi	74	03/04→10/10		72000001→; für Linkslenker; + ESP	24.2125-1703.3	010483	Ø 25,4
				72000001→; für Linkslenker; - ESP	24.2125-1704.3	010446	TRW Ø 25,4
				08/04→; → 62999999; für Rechtslenker	24.2125-1736.3	010904	TRW Ø 25,4
				08/04→; → 68999999; für Linkslenker; + ESP	24.2125-1736.3	010904	TRW Ø 25,4
				08/04→; → 68999999; für Linkslenker; - ESP	24.2125-1737.3	010906	TRW Ø 25,4
				72000001→; für Rechtslenker	24.4125-1703.3	010907	TRW Ø 25,4
1.7 CDTi	81 - 92	02/07→10/14		72000001→; für Linkslenker; + ESP	24.2125-1703.3	010483	Ø 25,4
				72000001→; für Linkslenker; - ESP	24.2125-1704.3	010446	TRW Ø 25,4
				04/07→; → 62999999; für Rechtslenker	24.2125-1736.3	010904	TRW Ø 25,4
				04/07→; → 68999999; für Linkslenker; + ESP	24.2125-1736.3	010904	TRW Ø 25,4
				04/07→; → 68999999; für Linkslenker; - ESP	24.2125-1737.3	010906	TRW Ø 25,4
				72000001→; für Rechtslenker	24.4125-1703.3	010907	TRW Ø 25,4
1.9 CDTi	74 - 110	09/04→12/12			03.4155-0156.3	010862	ATE Ø 25,4
1.9 CDTi 16V	88	08/04→10/10					











	kw				! #		
OPEL - ASTRA H Stufenheck (A04) 02/07→05/14							
 Hauptbremszylinder							
1.3 CDTi	66	02/07→10/10		→ 68999999; für Rechtslenker		24.2125-1736.3 010904	TRW Ø 25,4
1.4	66	02/07→06/10		→ 68999999; für Linkslenker; + ESP		24.2125-1736.3 010904	TRW Ø 25,4
1.6	77	02/07→06/10		→ 68999999; für Linkslenker; - ESP		24.2125-1737.3 010906	TRW Ø 25,4
1.7 CDTi	74	02/07→10/10		72000001→; für Rechtslenker		24.4125-1703.3 010907	TRW Ø 25,4
1.8	103	02/07→09/12		72000001→; für Linkslenker; + ESP		24.4125-1703.3 010907	TRW Ø 25,4
				72000001→; für Linkslenker; - ESP		24.4125-1704.3 010908	TRW Ø 25,4
1.6	85	02/07→05/14		→ 68999999; für Rechtslenker		24.2125-1736.3 010904	TRW Ø 25,4
				→ 68999999; für Linkslenker; + ESP		24.2125-1736.3 010904	TRW Ø 25,4
				→ 68999999; für Linkslenker; - ESP		24.2125-1737.3 010906	TRW Ø 25,4
				72000001→; → 11/10; für Rechtslenker		24.4125-1703.3 010907	TRW Ø 25,4
				72000001→; → 11/10; für Linkslenker; + ESP		24.4125-1703.3 010907	TRW Ø 25,4
				72000001→; → 11/10; für Linkslenker; - ESP		24.4125-1704.3 010908	TRW Ø 25,4
1.7 CDTi	81	02/07→05/14		04/07→; → 68999999; für Rechtslenker		24.2125-1736.3 010904	TRW Ø 25,4
				04/07→; → 68999999; für Linkslenker; + ESP		24.2125-1736.3 010904	TRW Ø 25,4
				04/07→; → 68999999; für Linkslenker; - ESP		24.2125-1737.3 010906	TRW Ø 25,4
				72000001→; → 11/10; für Rechtslenker		24.4125-1703.3 010907	TRW Ø 25,4
				72000001→; → 11/10; für Linkslenker; + ESP		24.4125-1703.3 010907	TRW Ø 25,4
				72000001→; → 11/10; für Linkslenker; - ESP		24.4125-1704.3 010908	TRW Ø 25,4
OPEL - ASTRA H TwinTop (A04) 09/05→10/10							
 Bremskraftverstärker							
1.9 CDTi	110	09/05→10/10		03/06→; für Linkslenker		03.7863-7803.4 300237	ATE Ø 10" pneumatisch
 Hauptbremszylinder							
1.6	77	09/05→10/10		03/06→; → 68999999; für Linkslenker; + ESP		24.2125-1736.3 010904	TRW Ø 25,4
1.8	92 - 103	09/05→10/10		03/06→; → 68999999; für Rechtslenker		24.2125-1736.3 010904	TRW Ø 25,4
2.0 Turbo	125 - 147	09/05→10/10		03/06→; → 68999999; für Linkslenker; - ESP		24.2125-1737.3 010906	TRW Ø 25,4
				03/06→; für Rechtslenker		24.4125-1703.3 010907	TRW Ø 25,4
				72000001→; für Linkslenker; + ESP		24.4125-1703.3 010907	TRW Ø 25,4
				72000001→; für Linkslenker; - ESP		24.4125-1704.3 010908	TRW Ø 25,4
1.6	85	12/06→10/10		→ 68999999; für Rechtslenker		24.2125-1736.3 010904	TRW Ø 25,4
1.6 Turbo	132	02/07→10/10		→ 68999999; für Linkslenker; + ESP		24.2125-1736.3 010904	TRW Ø 25,4
				→ 68999999; für Linkslenker; - ESP		24.2125-1737.3 010906	TRW Ø 25,4
				für Rechtslenker		24.4125-1703.3 010907	TRW Ø 25,4
				72000001→; für Linkslenker; + ESP		24.4125-1703.3 010907	TRW Ø 25,4
				72000001→; für Linkslenker; - ESP		24.4125-1704.3 010908	TRW Ø 25,4
1.9 CDTi	110	09/05→10/10		03/06→; für Rechtslenker		03.4155-0156.3 010862	ATE Ø 25,4
				03/06→; für Linkslenker; + ESP		03.4155-0156.3 010862	ATE Ø 25,4
OPEL - ASTRA J (P10) 09/09→04/16							
 Bremskraftverstärker							
1.3 CDTi	70	12/09→10/15		für Linkslenker		03.7858-0732.4 300272	ATE Ø 9 / 8" pneumatisch
1.4	64 - 74	12/09→10/15					
1.4 LPG	103	01/12→10/15					
1.4 Turbo	103	12/09→10/15					
1.6	85	12/09→10/15					
1.6 CDTi	81 - 100	11/13→10/15					
1.6 SIDI	125	12/12→10/15					
1.6 Turbo	132	12/09→10/15					
1.6 Turbo 4x4	132	12/09→10/15					
1.7 CDTi	81 - 96	09/09→10/15					
2.0 BiTurbo CDTi	143	09/12→10/15					
2.0 CDTi	96 - 121	09/09→10/15					
1.4 Turbo →	88	10/10→10/15		11/10→; für Linkslenker		03.7858-0732.4 300272	ATE Ø 9 / 8" pneumatisch













	kw			 	! #		
OPEL - ASTRA J (P10) 09/09→04/16							
 Hauptbremszylinder							
1.3 CDTI 1.4	70 64 - 74	12/09→10/15 12/09→10/15		für Linkslenker für Rechtslenker		03.2125-0421.3 010934 24.4155-0201.3 011125	ATE Ø 25,4 ATE Ø 25,4 ohne Bremsflüssigkeitsbehälter
1.4 LPG 1.4 Turbo 1.6 1.6 CDTi 1.6 SIDI 1.6 Turbo 1.6 Turbo 4x4 1.7 CDTI 2.0 CDTI	103 103 85 81 125 132 132 92 - 96 96 - 121	01/12→10/15 12/09→10/15 12/09→10/15 02/14→10/15 12/12→10/15 12/09→10/15 12/09→10/15 12/09→10/15 06/11→10/15					
1.4 Turbo	88	10/10→10/15		11/10→; für Linkslenker 11/10→; für Rechtslenker		03.2125-0421.3 010934 24.4155-0201.3 011125	ATE Ø 25,4 ATE Ø 25,4 ohne Bremsflüssigkeitsbehälter
1.6 CDTi	100	11/13→10/15		für Linkslenker 01/14→; für Rechtslenker		03.2125-0421.3 010934 24.4155-0201.3 011125	ATE Ø 25,4 ATE Ø 25,4 ohne Bremsflüssigkeitsbehälter
1.7 CDTI 2.0 CDTI	81 118	09/09→10/15 09/09→10/15		für Linkslenker 12/09→; für Rechtslenker		03.2125-0421.3 010934 24.4155-0201.3 011125	ATE Ø 25,4 ATE Ø 25,4 ohne Bremsflüssigkeitsbehälter
2.0 BiTurbo CDTI	143	09/12→10/15		für Linkslenker 12/12→; für Rechtslenker		03.2125-0421.3 010934 24.4155-0201.3 011125	ATE Ø 25,4 ATE Ø 25,4 ohne Bremsflüssigkeitsbehälter
OPEL - ASTRA J Caravan (P10) 10/10→10/15							
 Bremskraftverstärker							
1.3 CDTI 1.4	70 64 - 74	10/10→10/14 10/10→10/15		11/10→; für Linkslenker		03.7858-0732.4 300272	ATE Ø 9 / 8" pneumatisch
1.4 Turbo 1.6 1.6 Turbo 1.7 CDTI 2.0 CDTI	88 - 103 85 132 74 - 96 118	10/10→10/15 10/10→10/15 10/10→10/15 10/10→10/15 10/10→10/15					
1.4 LPG 1.6 CDTi	103 81 - 100	12/11→10/15 11/13→10/15		für Linkslenker		03.7858-0732.4 300272	ATE Ø 9 / 8" pneumatisch
1.6 SIDI 2.0 BiTurbo CDTI 2.0 CDTI	125 143 96 - 121	12/12→10/15 09/12→10/15 08/11→10/15					
 Hauptbremszylinder							
1.3 CDTI 1.4	70 64 - 74	10/10→10/14 10/10→10/15		11/10→; für Linkslenker 11/10→; für Rechtslenker		03.2125-0421.3 010934 24.4155-0201.3 011125	ATE Ø 25,4 ATE Ø 25,4 ohne Bremsflüssigkeitsbehälter
1.4 Turbo 1.6 1.6 Turbo 1.7 CDTI 2.0 CDTI	88 - 103 85 132 74 - 96 118	10/10→10/15 10/10→10/15 10/10→10/15 10/10→10/15 10/10→10/15					
1.4 LPG	103	12/11→10/15		für Linkslenker 01/12→; für Rechtslenker		03.2125-0421.3 010934 24.4155-0201.3 011125	ATE Ø 25,4 ATE Ø 25,4 ohne Bremsflüssigkeitsbehälter
1.6 CDTi 1.6 SIDI 2.0 CDTI	81 125 96 - 121	02/14→10/15 12/12→10/15 08/11→10/15		für Linkslenker für Rechtslenker		03.2125-0421.3 010934 24.4155-0201.3 011125	ATE Ø 25,4 ATE Ø 25,4 ohne Bremsflüssigkeitsbehälter
1.6 CDTi	100	11/13→10/15		für Linkslenker 01/14→; für Rechtslenker		03.2125-0421.3 010934 24.4155-0201.3 011125	ATE Ø 25,4 ATE Ø 25,4 ohne Bremsflüssigkeitsbehälter
2.0 BiTurbo CDTI	143	09/12→10/15		für Linkslenker 12/12→; für Rechtslenker		03.2125-0421.3 010934 24.4155-0201.3 011125	ATE Ø 25,4 ATE Ø 25,4 ohne Bremsflüssigkeitsbehälter













	kw			 	! #		
OPEL - ASTRA J GTC 10/11→04/18							
 Bremskraftverstärker							
1.4	74 - 88	10/11→04/18		für Linkslenker		03.7858-0732.4 300272	ATE Ø 9 / 8" pneumatisch
1.4 Turbo	103	10/11→04/18					
1.6 CDTI	81 - 100	07/14→04/18					
1.6 SIDI	125 - 147	12/12→04/18					
1.6 Turbo	132	10/11→06/13					
1.7 CDTI	81 - 96	03/12→06/14					
1.8	103	10/11→10/13					
2.0 BiTurbo CDTI	143	10/13→06/15					
2.0 CDTI	96 - 121	01/12→10/15					
 Hauptbremszylinder							
1.4	74 - 88	10/11→04/18		für Linkslenker		03.2125-0421.3 010934	ATE Ø 25,4
1.4 Turbo	103	10/11→04/18		für Rechtslenker		24.4155-0201.3 011125	ATE Ø 25,4 ohne Bremsflüssigkeitsbehälter
1.6 CDTI	81 - 100	07/14→04/18					
1.6 SIDI	125 - 147	12/12→04/18					
1.6 Turbo	132	10/11→06/13					
1.7 CDTI	81 - 96	03/12→06/14					
1.8	103	10/11→10/13					
2.0 BiTurbo CDTI	143	10/13→06/15					
2.0 CDTI	96 - 121	01/12→10/15					
OPEL - ASTRA J Kasten/Kombi (P10) 09/09→10/15							
 Bremskraftverstärker							
1.3 CDTi	70	10/12→10/15		für Linkslenker		03.7858-0732.4 300272	ATE Ø 9 / 8" pneumatisch
1.6 CDTi	81	01/14→10/15					
1.7 CDTi	96	10/12→10/15					
2.0 CDTi	121	10/12→10/15					
 Hauptbremszylinder							
1.3 CDTi	70	10/12→10/15		für Linkslenker		03.2125-0421.3 010934	ATE Ø 25,4
1.6 CDTi	81	01/14→10/15		für Rechtslenker		24.4155-0201.3 011125	ATE Ø 25,4 ohne Bremsflüssigkeitsbehälter
1.7 CDTi	96	10/12→10/15					
2.0 CDTi	121	10/12→10/15					
OPEL - ASTRA J Kasten/Schrägheck (P10) 09/09→10/15							
 Bremskraftverstärker							
1.3 CDTi	70	05/13→10/15		für Linkslenker		03.7858-0732.4 300272	ATE Ø 9 / 8" pneumatisch
1.6 CDTi	81 - 100	05/13→10/15					
1.7 CDTi	81	05/13→10/15					
 Hauptbremszylinder							
1.3 CDTi	70	05/13→10/15		für Linkslenker		03.2125-0421.3 010934	ATE Ø 25,4
1.6 CDTi	81 - 100	05/13→10/15		für Rechtslenker		24.4155-0201.3 011125	ATE Ø 25,4 ohne Bremsflüssigkeitsbehälter
1.7 CDTi	81	05/13→10/15					
OPEL - ASTRA J Stufenheck 06/12→							
 Bremskraftverstärker							
1.3 CDTI	70	06/12→10/15		für Linkslenker		03.7858-0732.4 300272	ATE Ø 9 / 8" pneumatisch
1.4	64 - 74	06/12→10/15					
1.4 LPG	103	07/14→					
1.4 Turbo	88 - 103	06/12→					
1.6	85	06/12→					
1.6 CDTI	81 - 100	01/14→					
1.6 SIDI	125	06/12→10/15					
1.6 Turbo	132	06/12→					
1.7 CDTI	74 - 96	06/12→10/15					
 Hauptbremszylinder							
1.3 CDTI	70	06/12→10/15		für Linkslenker		03.2125-0421.3 010934	ATE Ø 25,4
1.4	64 - 74	06/12→10/15		für Rechtslenker		24.4155-0201.3 011125	ATE Ø 25,4 ohne Bremsflüssigkeitsbehälter
→							











	kw					! #		
OPEL - ASTRA J Stufenheck 06/12→								
 Hauptbremszylinder								
1.4 LPG	103	07/14→		für Linkslenker		03.2125-0421.3	010934	ATE Ø 25,4
1.4 Turbo	88 - 103	06/12→		für Rechtslenker		24.4155-0201.3	011125	ATE Ø 25,4 ohne Bremsflüssigkeitsbehälter
1.6	85	06/12→						
1.6 CDTi	81 - 100	01/14→						
1.6 SIDI	125	06/12→10/15						
1.6 Turbo	132	06/12→						
1.7 CDTi	74 - 96	06/12→10/15						
OPEL - CASCADA (W13) 03/13→04/19								
 Bremskraftverstärker								
1.4	88	04/13→04/18		für Linkslenker		03.7858-0732.4	300272	ATE Ø 9 / 8" pneumatisch
1.4 Turbo	103	03/13→04/18						
1.6	100 - 147	11/13→04/19						
1.6 SIDI	125	04/13→04/19						
2.0 CDTi	121 - 143	04/13→04/18						
 Hauptbremszylinder								
1.4	88	04/13→04/18		für Linkslenker		03.2125-0421.3	010934	ATE Ø 25,4
1.4 Turbo	103	03/13→04/18		für Rechtslenker		24.4155-0201.3	011125	ATE Ø 25,4 ohne Bremsflüssigkeitsbehälter
1.6	100 - 147	11/13→04/19						
1.6 SIDI	125	04/13→04/19						
2.0 CDTi	121 - 143	04/13→04/18						
OPEL - COMBO Kasten/Großraumlimousine 10/01→								
 Hauptbremszylinder								
1.3 CDTi 16V	51 - 55	08/05→		→ 33999999		24.2122-1740.3	010711	DEL Ø 22,2
1.4 16V	66	08/05→		43000001→; → 10/11; - ESP; Scheibenbremse		24.2123-1767.3	010844	BOS Ø 23,8
1.6	64	10/01→						
1.7 DI 16V	48	10/01→						
1.7 DTi 16V	55	10/01→						
1.6 CNG 16V	69 - 71	04/05→		→ 10/11; - ESP; Scheibenbremse		24.2123-1767.3	010844	BOS Ø 23,8
1.7 CDTi 16V	74	12/04→						
OPEL - COMBO Kasten/Großraumlimousine (71_) 07/94→10/01								
 Hauptbremszylinder								
1.2	33	07/94→10/01		→ 09/00; für Linkslenker; - ABS		24.2120-0702.3	010361	nicht für Delco Ø 20,6
1.4	44 - 60	07/94→10/01		→ 09/00; für Linkslenker; + ABS		24.2120-1714.3	010455	Ø 20,6
1.4 16V	66	08/99→10/01						
1.7 D	44	07/94→10/01						
OPEL - COMBO Tour 10/01→12/11								
 Hauptbremszylinder								
1.3 CDTi 16V	51	06/04→01/11		→ 33999999		24.2122-1740.3	010711	DEL Ø 22,2
1.6	62 - 64	10/01→09/06		43000001→; - ESP; Scheibenbremse		24.2123-1767.3	010844	BOS Ø 23,8
1.7 DI 16V	48	10/01→06/04						
1.7 DTi 16V	55	10/01→06/04						
1.3 CDTi 16V	55	10/05→12/11		→ 33999999		24.2122-1740.3	010711	DEL Ø 22,2
1.4	66	10/04→12/11		43000001→; → 10/11; - ESP; Scheibenbremse		24.2123-1767.3	010844	BOS Ø 23,8
1.6 CNG	69	06/06→12/11		→ 10/11; - ESP; Scheibenbremse		24.2123-1767.3	010844	BOS Ø 23,8
1.7 CDTi 16V	74	07/04→12/11						
1.6 CNG	71	04/05→01/11		- ESP; Scheibenbremse		24.2123-1767.3	010844	BOS Ø 23,8
OPEL - CORSA B (S93) 03/93→10/09								
 Hauptbremszylinder								
1.0 i 12V	40	11/96→09/00		für Linkslenker; - ABS		24.2120-0702.3	010361	nicht für Delco Ø 20,6
1.2 i	33	03/93→09/00		für Linkslenker; + ABS		24.2120-1714.3	010455	Ø 20,6
1.4 i	40 - 44	03/93→09/00						
1.4 i 16V	63 - 66	09/94→09/00						
1.4 Si	60	03/93→09/00						
1.5 D	37	03/93→09/00						
1.5 TD	49	03/93→09/00						
→								















	kw					! #		
OPEL - CORSA B (S93) 03/93→10/09								
 Hauptbremszylinder								
1.6 i 16V	74	09/94→09/00			für Linkslenker; - ABS		24.2120-0702.3 010361	nicht für Delco Ø 20,6
1.7 D	44	02/96→09/00			für Linkslenker; + ABS		24.2120-1714.3 010455	Ø 20,6
1.2 i 16V	48	03/98→09/00			04/98→; für Linkslenker; - ABS		24.2120-0702.3 010361	nicht für Delco Ø 20,6
					04/98→; für Linkslenker; + ABS		24.2120-1714.3 010455	Ø 20,6
1.6 GSI 16V	80	03/93→09/00			09/93→; für Linkslenker; - ABS		24.2120-0702.3 010361	nicht für Delco Ø 20,6
					09/93→; für Linkslenker; + ABS		24.2120-1714.3 010455	Ø 20,6
OPEL - CORSA B Kasten/Schrägheck (S93) 08/94→12/01								
 Hauptbremszylinder								
1.4 i	44	08/99→09/00			für Linkslenker; - ABS		24.2120-0702.3 010361	nicht für Delco Ø 20,6
1.7 D	44	08/99→09/00			für Linkslenker; + ABS		24.2120-1714.3 010455	Ø 20,6
OPEL - CORSA B Kombi (S93) 04/98→12/02								
 Hauptbremszylinder								
1.4 i 16V	66	01/99→12/02			→ 09/00; für Linkslenker; - ABS		24.2120-0702.3 010361	nicht für Delco Ø 20,6
1.7 D	44	01/99→12/02			→ 09/00; für Linkslenker; + ABS		24.2120-1714.3 010455	Ø 20,6
OPEL - CORSA C (X01) 09/00→12/09								
 Hauptbremszylinder								
1.0	43 - 44	09/00→12/09			→ 36999999		24.2122-1740.3 010711	DEL Ø 22,2
1.2	55	09/00→12/09						
1.2 Twinport	59	07/04→12/09						
1.3 CDTI	51	06/03→12/09						
1.7 CDTI	74	06/03→12/09						
1.7 DI	48	09/00→12/09						
1.7 DTI	55	09/00→12/09						
1.4	60	01/02→12/09			43000001→; - ESP		24.2123-1767.3 010844	BOS Ø 23,8
1.8	79	01/02→12/09						
1.4	66	09/00→12/09			43000001→; → 09/06; - ESP		24.2123-1767.3 010844	BOS Ø 23,8
1.4 Twinport	66	06/03→12/09						
1.8	92	09/00→12/09						
OPEL - CORSA C Kasten/Schrägheck (X01) 09/00→12/12								
 Hauptbremszylinder								
1.2	59	07/05→06/06			→ 36999999		24.2122-1740.3 010711	DEL Ø 22,2
1.2 16V	55	09/00→07/03						
1.3 CDTI 16V	51 - 59	07/05→06/06						
1.7 CDTi	74	08/03→12/12						
1.7 DI 16V	48	09/00→07/03						
1.7 DTI 16V	55	09/00→07/03						
1.4	66	08/03→06/12			43000001→; → 09/06; - ESP		24.2123-1767.3 010844	BOS Ø 23,8
OPEL - CORSA D (S07) 07/06→04/15								
 Hauptbremszylinder								
1.0	44	07/06→12/10			10/06→; für Linkslenker; + ESP		24.4122-1705.3 010852	BOS Ø 22,2 ohne Bremsflüssigkeitsbehälter
1.2	59	07/06→08/14						
1.3 CDTI	55 - 66	07/06→08/14			10/06→; für Linkslenker; - ESP		24.4122-1709.3 010871	BOS Ø 22,2 ohne Bremsflüssigkeitsbehälter
1.4	66	07/06→08/14						
1.4 LPG	66	08/06→12/11			10/06→; für Rechtslenker; + ESP		24.4122-1737.3 011147	BOS Ø 22,2 ohne Bremsflüssigkeitsbehälter
					10/06→; für Rechtslenker; - ESP		24.4122-1738.3 011148	BOS Ø 22,2 ohne Bremsflüssigkeitsbehälter
1.0	48	12/09→08/14			für Linkslenker; + ESP		24.4122-1705.3 010852	BOS Ø 22,2 ohne Bremsflüssigkeitsbehälter
1.2 LPG	55 - 63	09/09→08/14						
1.4	64	09/09→08/14			für Linkslenker; - ESP		24.4122-1709.3 010871	BOS Ø 22,2 ohne Bremsflüssigkeitsbehälter
1.4 LPG	64	09/09→08/14			für Rechtslenker; + ESP		24.4122-1737.3 011147	BOS Ø 22,2 ohne Bremsflüssigkeitsbehälter
					für Rechtslenker; - ESP		24.4122-1738.3 011148	BOS Ø 22,2 ohne Bremsflüssigkeitsbehälter
1.2	51 - 63	12/09→08/14			für Linkslenker; + ESP		24.4122-1705.3 010852	BOS Ø 22,2 ohne Bremsflüssigkeitsbehälter
1.3 CDTI	70	06/09→08/14			für Linkslenker; - ESP		24.4122-1709.3 010871	BOS Ø 22,2 ohne Bremsflüssigkeitsbehälter
1.4	74	12/09→08/14			06/10→; für Rechtslenker; + ESP		24.4122-1737.3 011147	BOS Ø 22,2 ohne Bremsflüssigkeitsbehälter
→								

	kw			 	! #		
OPEL - CORSA D (S07) 07/06→04/15							
 Hauptbremszylinder							
1.2 1.3 CDTI 1.4	51 - 63 70 74	12/09→08/14 06/09→08/14 12/09→08/14		06/10→; für Rechtslenker; - ESP		24.4122-1738.3 011148	BOS Ø 22,2 ohne Bremsflüssigkeitsbehälter
1.2 LPG	59	08/06→08/14		für Linkslenker; + ESP		24.4122-1705.3 010852	BOS Ø 22,2 ohne Bremsflüssigkeitsbehälter
				für Linkslenker; - ESP		24.4122-1709.3 010871	BOS Ø 22,2 ohne Bremsflüssigkeitsbehälter
				09/09→; für Rechtslenker; + ESP		24.4122-1737.3 011147	BOS Ø 22,2 ohne Bremsflüssigkeitsbehälter
				09/09→; für Rechtslenker; - ESP		24.4122-1738.3 011148	BOS Ø 22,2 ohne Bremsflüssigkeitsbehälter
1.4 1.6 Turbo 1.7 CDTI	88 155 96	07/12→08/14 06/11→08/14 12/09→08/14		für Linkslenker; - ESP		24.4123-1720.3 011022	BOS Ø 23,8 ohne Bremsflüssigkeitsbehälter
1.6 Turbo	110	05/07→08/14		06/07→; für Linkslenker; - ESP		24.4123-1720.3 011022	BOS Ø 23,8 ohne Bremsflüssigkeitsbehälter
1.6 Turbo	141	11/06→08/14		03/07→; für Linkslenker; - ESP		24.4123-1720.3 011022	BOS Ø 23,8 ohne Bremsflüssigkeitsbehälter
1.7 CDTI	92	08/06→12/11		10/06→; für Linkslenker; - ESP		24.4123-1720.3 011022	BOS Ø 23,8 ohne Bremsflüssigkeitsbehälter
OPEL - CORSA D Kasten/Schrägheck (S07) 07/06→08/14							
 Hauptbremszylinder							
1.0 1.3 CDTI	44 55 - 66	08/06→08/14 07/06→08/14		10/06→; für Linkslenker; + ESP		24.4122-1705.3 010852	BOS Ø 22,2 ohne Bremsflüssigkeitsbehälter
				10/06→; für Linkslenker; - ESP		24.4122-1709.3 010871	BOS Ø 22,2 ohne Bremsflüssigkeitsbehälter
				10/06→; für Rechtslenker; + ESP		24.4122-1737.3 011147	BOS Ø 22,2 ohne Bremsflüssigkeitsbehälter
				10/06→; für Rechtslenker; - ESP		24.4122-1738.3 011148	BOS Ø 22,2 ohne Bremsflüssigkeitsbehälter
1.0 1.2 1.4	48 63 74	01/10→08/14 06/10→08/14 07/12→08/14		für Linkslenker; + ESP		24.4122-1705.3 010852	BOS Ø 22,2 ohne Bremsflüssigkeitsbehälter
				für Linkslenker; - ESP		24.4122-1709.3 010871	BOS Ø 22,2 ohne Bremsflüssigkeitsbehälter
				für Rechtslenker; + ESP		24.4122-1737.3 011147	BOS Ø 22,2 ohne Bremsflüssigkeitsbehälter
				für Rechtslenker; - ESP		24.4122-1738.3 011148	BOS Ø 22,2 ohne Bremsflüssigkeitsbehälter
1.2 1.3 CDTI	51 70	01/10→08/14 11/09→08/14		für Linkslenker; + ESP		24.4122-1705.3 010852	BOS Ø 22,2 ohne Bremsflüssigkeitsbehälter
				für Linkslenker; - ESP		24.4122-1709.3 010871	BOS Ø 22,2 ohne Bremsflüssigkeitsbehälter
				06/10→; für Rechtslenker; + ESP		24.4122-1737.3 011147	BOS Ø 22,2 ohne Bremsflüssigkeitsbehälter
				06/10→; für Rechtslenker; - ESP		24.4122-1738.3 011148	BOS Ø 22,2 ohne Bremsflüssigkeitsbehälter
1.2	59	08/06→08/14		für Linkslenker; + ESP		24.4122-1705.3 010852	BOS Ø 22,2 ohne Bremsflüssigkeitsbehälter
				für Linkslenker; - ESP		24.4122-1709.3 010871	BOS Ø 22,2 ohne Bremsflüssigkeitsbehälter
				10/06→; für Rechtslenker; + ESP		24.4122-1737.3 011147	BOS Ø 22,2 ohne Bremsflüssigkeitsbehälter
				10/06→; für Rechtslenker; - ESP		24.4122-1738.3 011148	BOS Ø 22,2 ohne Bremsflüssigkeitsbehälter
1.4 1.6 1.7 CDTI	88 141 96	07/12→08/14 07/12→08/14 07/12→08/14		für Linkslenker; - ESP		24.4123-1720.3 011022	BOS Ø 23,8 ohne Bremsflüssigkeitsbehälter
OPEL - CORSA E (X15) 09/14→							
 Hauptbremszylinder							
1.0 1.2 1.3 CDTI 1.4	66 - 85 51 55 - 70 66	09/14→ 09/14→ 09/14→ 09/14→		für Linkslenker; Trommelbremse		24.4122-1731.3 011100	Ø 22,2 ohne Bremsflüssigkeitsbehälter
1.4 Turbo	74	09/14→06/19		11/14→; für Linkslenker; Scheibenbremse		24.4123-1722.3 011071	Ø 23,8 ohne Bremsflüssigkeitsbehälter
1.4 LPG	64 - 66	03/15→		für Linkslenker; Trommelbremse		24.4122-1731.3 011100	Ø 22,2 ohne Bremsflüssigkeitsbehälter
→							















	kw			 	! #		
OPEL - CORSA E (X15) 09/14→							
 Hauptbremszylinder							
1.4 LPG	64 - 66	03/15→		für Linkslenker; Scheibenbremse		24.4123-1722.3 011071	Ø 23,8 ohne Bremsflüssigkeitsbehälter
1.6 Turbo	152	03/15→		für Linkslenker		24.4123-1722.3 011071	Ø 23,8 ohne Bremsflüssigkeitsbehälter
OPEL - CORSA E Kasten/Schrägheck (X15) 09/14→							
 Hauptbremszylinder							
1.2	51	01/15→		für Linkslenker; Trommelbremse		24.4122-1731.3 011100	Ø 22,2 ohne Bremsflüssigkeitsbehälter
1.3 CDTI	55	01/15→		für Linkslenker; Scheibenbremse		24.4123-1722.3 011071	Ø 23,8 ohne Bremsflüssigkeitsbehälter
1.3 CDTI	70	09/14→		für Linkslenker; Trommelbremse		24.4122-1731.3 011100	Ø 22,2 ohne Bremsflüssigkeitsbehälter
1.4	55 - 66	09/14→		11/14→; für Linkslenker; Scheibenbremse		24.4123-1722.3 011071	Ø 23,8 ohne Bremsflüssigkeitsbehälter
OPEL - CROSSLAND X / CROSSLAND (P17, P2QO) 03/17→							
 Hauptbremszylinder							
1.2	60 - 96	03/17→				24.4123-1704.3 010828	TRW Ø 23,8
1.2 LPG	60	10/17→					
1.5	81	10/20→					
1.5 Turbo D	75 - 88	06/18→					
1.6 Turbo D	73 - 88	03/17→04/19					
OPEL - CROSSLAND X Van 03/17→							
 Hauptbremszylinder							
1.2	61 - 81	07/19→				24.4123-1704.3 010828	TRW Ø 23,8
1.5	75	06/18→					
OPEL - INSIGNIA A (G09) 07/08→03/17							
 Bremskraftverstärker							
1.4	103	04/11→03/17		06/11→; für Linkslenker		03.7858-0732.4 300272	ATE Ø 9 / 8" pneumatisch
1.4 LPG	103	07/12→03/17		für Linkslenker		03.7858-0732.4 300272	ATE Ø 9 / 8" pneumatisch
1.6	85	07/08→03/17					
1.6 CDTi	88 - 100	07/15→03/17					
1.6 SIDI	125	03/13→03/17					
1.8	103	07/08→03/17					
2.0 Biturbo CDTI	140 - 143	07/08→03/17					
2.0 Biturbo CDTI 4x4	140 - 143	05/09→03/17					
2.0 CDTI	81 - 125	07/08→03/17					
2.0 CDTI 4x4	118 - 125	06/10→03/17					
2.0 E85 Turbo	162	10/10→03/17					
2.0 Turbo	162 - 184	07/08→03/17					
2.0 Turbo 4x4	162 - 184	07/08→03/17					
1.6 Turbo	132	07/08→03/17		10/08→; für Linkslenker		03.7858-0732.4 300272	ATE Ø 9 / 8" pneumatisch
2.0 CDTI	88	03/12→03/17		03/13→; für Linkslenker		03.7858-0732.4 300272	ATE Ø 9 / 8" pneumatisch
 Hauptbremszylinder							
1.4	103	04/11→03/17		06/11→; für Linkslenker		03.2125-0421.3 010934	ATE Ø 25,4
				06/11→; für Rechtslenker		24.4155-0201.3 011125	ATE Ø 25,4 ohne Bremsflüssigkeitsbehälter
1.4 LPG	103	07/12→03/17		für Linkslenker		03.2125-0421.3 010934	ATE Ø 25,4
1.6	85	07/08→03/17					
1.6 CDTi	88 - 100	07/15→03/17		für Rechtslenker		24.4155-0201.3 011125	ATE Ø 25,4 ohne Bremsflüssigkeitsbehälter
1.6 SIDI	125	03/13→03/17					
1.8	103	07/08→03/17					
2.0 Biturbo CDTI	140 - 143	07/08→03/17					
2.0 Biturbo CDTI 4x4	140 - 143	05/09→03/17					
2.0 CDTI	81 - 125	07/08→03/17					
→							

	kw			 	! #		
OPEL - INSIGNIA A (G09) 07/08→03/17							
 Hauptbremszylinder							
2.0 CDTi 4x4	118 - 125	06/10→03/17		für Linkslenker		03.2125-0421.3 010934	ATE Ø 25,4
2.0 E85 Turbo 2.0 Turbo	162 - 184	10/10→03/17 07/08→03/17		für Rechtslenker		24.4155-0201.3 011125	ATE Ø 25,4 ohne Bremsflüssigkeitsbehälter
2.0 Turbo 4x4 2.8 V6 Turbo 4x4 2.8 V6 Turbo OPC 4x4	162 - 239	07/08→03/17 07/08→03/17 07/09→03/17					
1.6 Turbo	132	07/08→03/17		10/08→; für Linkslenker		03.2125-0421.3 010934	ATE Ø 25,4
				10/08→; für Rechtslenker		24.4155-0201.3 011125	ATE Ø 25,4 ohne Bremsflüssigkeitsbehälter
2.0 CDTi	88	03/12→03/17		03/13→; für Linkslenker		03.2125-0421.3 010934	ATE Ø 25,4
				03/13→; für Rechtslenker		24.4155-0201.3 011125	ATE Ø 25,4 ohne Bremsflüssigkeitsbehälter
2.0 CDTi	103	06/13→03/17		für Linkslenker		03.2125-0421.3 010934	ATE Ø 25,4
				07/13→; für Rechtslenker		24.4155-0201.3 011125	ATE Ø 25,4 ohne Bremsflüssigkeitsbehälter
2.0 Turbo 4x4	184	07/11→03/17		für Linkslenker		03.2125-0421.3 010934	ATE Ø 25,4
				09/11→; für Rechtslenker		24.4155-0201.3 011125	ATE Ø 25,4 ohne Bremsflüssigkeitsbehälter
OPEL - INSIGNIA A Country Tourer (G09) 07/08→03/17							
 Bremskraftverstärker							
1.6 CDTi 1.6 SIDI 2.0 CDTi	88 - 125	07/15→03/17 07/14→03/17 07/08→03/17		für Linkslenker		03.7858-0732.4 300272	ATE Ø 9 / 8" pneumatisch
2.0 CDTi 4x4 2.0 Turbo 4x4	120 - 184	09/13→03/17 09/13→03/17					
 Hauptbremszylinder							
1.6 CDTi 1.6 SIDI 2.0 CDTi	88 - 125	07/15→03/17 07/14→03/17 07/08→03/17		für Linkslenker		03.2125-0421.3 010934	ATE Ø 25,4
2.0 CDTi 4x4 2.0 Turbo 4x4	120 - 184	09/13→03/17 09/13→03/17		für Rechtslenker		24.4155-0201.3 011125	ATE Ø 25,4 ohne Bremsflüssigkeitsbehälter
OPEL - INSIGNIA A Sports Tourer (G09) 07/08→03/17							
 Bremskraftverstärker							
1.4 1.4 LPG 1.6 1.6 CDTi	103 - 100	04/11→03/17 09/12→03/17 07/08→06/12 07/15→01/17		für Linkslenker		03.7858-0732.4 300272	ATE Ø 9 / 8" pneumatisch
1.6 SIDI 1.6 Turbo 1.8 2.0 Biturbo CDTi	125 - 143	06/13→03/17 01/09→06/13 07/08→03/17 07/08→03/17					
2.0 Biturbo CDTi 4x4 2.0 CDTi 2.0 CDTi 4x4	140 - 125	07/08→03/17 07/08→12/16 06/10→12/16					
2.0 E85 Turbo 2.0 Turbo 2.0 Turbo 4x4	162 - 184	09/10→11/11 07/08→03/17 07/08→03/17					
2.0 CDTi	88	03/12→06/15		03/13→; für Linkslenker		03.7858-0732.4 300272	ATE Ø 9 / 8" pneumatisch
 Hauptbremszylinder							
1.4 1.4 LPG 1.6 1.6 CDTi	103 - 100	04/11→03/17 09/12→03/17 07/08→06/12 07/15→01/17		für Linkslenker		03.2125-0421.3 010934	ATE Ø 25,4
1.6 SIDI 1.6 Turbo 1.8 →	125 - 103	06/13→03/17 01/09→06/13 07/08→03/17		für Rechtslenker		24.4155-0201.3 011125	ATE Ø 25,4 ohne Bremsflüssigkeitsbehälter













	kw					! #		
OPEL - INSIGNIA A Sports Tourer (G09) 07/08→03/17								
 Hauptbremszylinder								
2.0 Biturbo CDTI	140 - 143	07/08→03/17		für Linkslenker		03.2125-0421.3	010934	ATE Ø 25,4
2.0 Biturbo CDTI 4x4	140 - 143	07/08→03/17		für Rechtslenker		24.4155-0201.3	011125	ATE Ø 25,4 ohne Bremsflüssigkeitsbehälter
2.0 CDTI	81 - 125	07/08→12/16						
2.0 CDTI 4x4	118 - 125	06/10→12/16						
2.0 E85 Turbo	162	09/10→11/11						
2.0 Turbo	162 - 184	07/08→03/17						
2.0 Turbo 4x4	162 - 184	07/08→03/17						
2.8 V6 Turbo 4x4	191	10/08→06/13						
2.8 V6 Turbo OPC 4x4	239	07/09→03/17						
2.0 CDTI	88	03/12→06/15		03/13→; für Linkslenker		03.2125-0421.3	010934	ATE Ø 25,4
				03/13→; für Rechtslenker		24.4155-0201.3	011125	ATE Ø 25,4 ohne Bremsflüssigkeitsbehälter
OPEL - INSIGNIA A Stufenheck (G09) 07/08→03/17								
 Bremskraftverstärker								
1.4	103	04/11→03/17		06/11→; für Linkslenker		03.7858-0732.4	300272	ATE Ø 9 / 8" pneumatisch
1.4 LPG	103	07/12→03/17		für Linkslenker		03.7858-0732.4	300272	ATE Ø 9 / 8" pneumatisch
1.6	85	07/08→03/17						
1.6 CDTi	88 - 100	07/15→03/17						
1.6 SIDI	125	03/13→03/17						
1.6 Turbo	132	07/08→03/17						
1.8	103	07/08→03/17						
2.0 Biturbo CDTI	140 - 143	07/08→03/17						
2.0 Biturbo CDTI 4x4	140 - 143	07/08→03/17						
2.0 CDTI	81 - 125	07/08→03/17						
2.0 CDTI 4x4	118 - 125	06/10→03/17						
2.0 Turbo	162 - 184	07/08→03/17						
2.0 Turbo 4x4	162 - 184	07/08→03/17						
2.0 Turbo E85	162	07/08→03/17						
2.0 CDTI	88	03/12→03/17		03/13→; für Linkslenker		03.7858-0732.4	300272	ATE Ø 9 / 8" pneumatisch
 Hauptbremszylinder								
1.4	103	04/11→03/17		06/11→; für Linkslenker		03.2125-0421.3	010934	ATE Ø 25,4
				06/11→; für Rechtslenker		24.4155-0201.3	011125	ATE Ø 25,4 ohne Bremsflüssigkeitsbehälter
1.4 LPG	103	07/12→03/17		für Linkslenker		03.2125-0421.3	010934	ATE Ø 25,4
1.6	85	07/08→03/17						
1.6 CDTi	88 - 100	07/15→03/17		für Rechtslenker		24.4155-0201.3	011125	ATE Ø 25,4 ohne Bremsflüssigkeitsbehälter
1.6 SIDI	125	03/13→03/17						
1.8	103	07/08→03/17						
2.0 Biturbo CDTI	140 - 143	07/08→03/17						
2.0 Biturbo CDTI 4x4	140 - 143	07/08→03/17						
2.0 CDTI	81 - 125	07/08→03/17						
2.0 CDTI 4x4	118 - 125	06/10→03/17						
2.0 Turbo	162 - 184	07/08→03/17						
2.0 Turbo 4x4	162	07/08→03/17						
2.0 Turbo E85	162	07/08→03/17						
2.8 V6 Turbo 4x4	191	07/08→03/17						
2.8 V6 Turbo OPC 4x4	239	07/09→03/17						
1.6 Turbo	132	07/08→03/17		für Linkslenker		03.2125-0421.3	010934	ATE Ø 25,4
				10/08→; für Rechtslenker		24.4155-0201.3	011125	ATE Ø 25,4 ohne Bremsflüssigkeitsbehälter
2.0 CDTI	88	03/12→03/17		03/13→; für Linkslenker		03.2125-0421.3	010934	ATE Ø 25,4
				03/13→; für Rechtslenker		24.4155-0201.3	011125	ATE Ø 25,4 ohne Bremsflüssigkeitsbehälter
2.0 CDTI	103	06/13→03/17		für Linkslenker		03.2125-0421.3	010934	ATE Ø 25,4
				07/13→; für Rechtslenker		24.4155-0201.3	011125	ATE Ø 25,4 ohne Bremsflüssigkeitsbehälter
→								











	kw					! #		
OPEL - INSIGNIA A Stufenheck (G09) 07/08→03/17								
 Hauptbremszylinder								
2.0 Turbo 4x4	184	07/11→03/17		für Linkslenker		03.2125-0421.3	010934	ATE Ø 25,4
				09/11→; für Rechtslenker		24.4155-0201.3	011125	ATE Ø 25,4 ohne Bremsflüssigkeitsbehälter
OPEL - MERIVA A Großraumlimousine (X03) 05/03→05/10								
 Hauptbremszylinder								
1.3 CDTI	51 - 55	09/03→05/10		→ 44999999; - ESP		24.2123-1764.3	010824	TRW Ø 23,8
1.4 16V Twinport	66	07/04→05/10		54000001→ 74237191; + ESP		24.2123-1784.3	011164	BOS Ø 23,8 ohne Bremsflüssigkeitsbehälter
1.4 16V Twinport LPG	66	07/04→05/10						
1.6	64 - 77	05/03→05/10		74237192→; + ESP		24.4123-1717.3	010985	TRW Ø 23,8 ohne Bremsflüssigkeitsbehälter
1.6 16V	74	05/03→01/06						
1.6 Turbo	132	09/05→05/10						
1.7 CDTI	74 - 92	09/03→05/10						
1.7 DTI	55	09/03→05/10						
1.8	92	05/03→05/10						
OPEL - MOKKA / MOKKA X (J13) 06/12→								
 Hauptbremszylinder								
1.4	88 - 103	04/13→		für Linkslenker		24.4123-1738.3	011124	Ø 23,8 ohne Bremsflüssigkeitsbehälter
1.4 4x4	103 - 112	06/12→						
1.4 LPG	103	04/13→						
1.6	85	06/12→						
1.6 CDTI	81 - 100	01/15→						
1.6 CDTI 4x4	81 - 100	01/15→						
1.7 CDTI	96	06/12→						
1.7 CDTI 4x4	96	06/12→						
1.8	103	01/13→						
1.8 4x4	103	01/13→						
OPEL - MOKKA X VAN (J13) 06/12→								
 Hauptbremszylinder								
1.6 CDTi	100	03/18→		für Linkslenker		24.4123-1738.3	011124	Ø 23,8 ohne Bremsflüssigkeitsbehälter
OPEL - MOVANO A Bus (X70) 07/98→								
 Hauptbremszylinder								
1.9 DTI	59	09/00→10/01		+ ABS		24.2025-1706.3	010676	Ø 25,4
2.5 D	59	07/98→09/00		- ABS		24.2025-1708.3	010692	Ø 25,4
2.8 DTI	84	07/98→10/01						
1.9 DTI	60	10/01→		→ 08/03; + ABS		24.2025-1706.3	010676	Ø 25,4
2.2 DTI	66	09/00→		→ 01/10; - ABS		24.2025-1708.3	010692	Ø 25,4
2.5 DTI	84	10/01→		09/03→; + ABS; → 08/06		24.2123-1759.3	010768	BOS Ø 23,8
3.0 DTi	100	10/03→		→ 01/10; - ABS		24.2025-1708.3	010692	Ø 25,4
				→ 08/06; + ABS		24.2123-1759.3	010768	BOS Ø 23,8
OPEL - MOVANO A Kasten (X70) 01/99→								
 Hauptbremszylinder								
1.9 DTI	59	09/00→10/01		+ ABS		24.2025-1706.3	010676	Ø 25,4
2.5 D	59	01/99→09/00		- ABS		24.2025-1708.3	010692	Ø 25,4
2.8 DTI	84	01/99→10/01						
1.9 DTI	60	10/01→		→ 08/03; + ABS		24.2025-1706.3	010676	Ø 25,4
2.2 DTI	66	09/00→		→ 01/10; - ABS		24.2025-1708.3	010692	Ø 25,4
2.5 DTI	84	10/01→		09/03→; + ABS; → 08/06		24.2123-1759.3	010768	BOS Ø 23,8
2.5 DTi	73	10/03→		→ 01/10; - ABS		24.2025-1708.3	010692	Ø 25,4
3.0 DTI	100	10/03→		+ ABS; → 08/06		24.2123-1759.3	010768	BOS Ø 23,8
OPEL - MOVANO A Pritsche/Fahrgestell (X70) 07/98→								
 Hauptbremszylinder								
2.2 DTI	66	09/00→		→ 08/03; + ABS		24.2025-1706.3	010676	Ø 25,4
2.5 DTI	84	10/01→		→ 01/10; - ABS		24.2025-1708.3	010692	Ø 25,4
				09/03→; + ABS; → 08/06		24.2123-1759.3	010768	BOS Ø 23,8
2.5 D	59	07/98→09/00		+ ABS		24.2025-1706.3	010676	Ø 25,4
2.8 DTI	84	07/98→10/01		- ABS		24.2025-1708.3	010692	Ø 25,4
→								













	kw					! #		
OPEL - MOVANO A Pritsche/Fahrgestell (X70) 07/98→								
 Hauptbremszylinder								
2.5 DTi	73	10/03→			→ 01/10; - ABS		24.2025-1708.3 010692	Ø 25,4
3.0 DTi	100	10/03→			→ 08/06; + ABS		24.2123-1759.3 010768	BOS Ø 23,8
OPEL - MOVANO C Kasten (U9) 12/21→								
 Hauptbremszylinder								
2.2 BlueHDi 120	88	11/23→			- DSC		24.4125-1717.3 011157	BOS Ø 25,4 ohne Bremsflüssigkeitsbehälter
2.2 BlueHDi 140	103	11/23→						
2.2 BlueHDi 180	132	11/23→						
2.2 D	88 - 121	12/21→10/23			Nutzlast-Code: Nutzlast leicht / 12Q / 14Q / 16Q; + DSC		24.4125-1718.3 011158	BOS Ø 25,4 ohne Bremsflüssigkeitsbehälter
MOVANO-e	100	12/21→10/23			Nutzlast-Code: Nutzlast schwer / 16Q; + DSC		24.4125-1718.3 011158	BOS Ø 25,4 ohne Bremsflüssigkeitsbehälter
					Nutzlast-Code: Nutzlast schwer / 20Q		24.4126-1705.3 011160	Ø 27 ohne Bremsflüssigkeitsbehälter
OPEL - MOVANO C Pritsche/Fahrgestell (U9) 12/21→								
 Hauptbremszylinder								
2.2 BlueHDi 120	88	11/23→			- DSC		24.4125-1717.3 011157	BOS Ø 25,4 ohne Bremsflüssigkeitsbehälter
2.2 BlueHDi 140	103	11/23→						
2.2 BlueHDi 180	132	11/23→						
2.2 D	88 - 121	12/21→10/23			Nutzlast-Code: Nutzlast schwer / 16Q; + DSC		24.4125-1718.3 011158	BOS Ø 25,4 ohne Bremsflüssigkeitsbehälter
					Nutzlast-Code: Nutzlast leicht / 12Q / 14Q / 16Q; + DSC		24.4125-1718.3 011158	BOS Ø 25,4 ohne Bremsflüssigkeitsbehälter
					Nutzlast-Code: Nutzlast schwer / 20Q		24.4126-1705.3 011160	Ø 27 ohne Bremsflüssigkeitsbehälter
OPEL - OMEGA B (V94) 03/94→12/05								
 Hauptbremszylinder								
2.0	85	03/94→12/00			W1000001→; → 09/99; für Linkslenker; + ESP		24.2125-1740.3 010971	TRW Ø 25,4
2.0 DTi 16V	74	09/97→09/00			→ 08/00; für Linkslenker; + ESP		24.2125-1740.3 010971	TRW Ø 25,4
2.2 16V	106	09/99→07/03			10/99→; für Linkslenker; + ESP		24.2125-1740.3 010971	TRW Ø 25,4
2.2 DTi 16V	81 - 88	09/00→07/03			für Linkslenker; + ESP		24.2125-1740.3 010971	TRW Ø 25,4
2.5 DTi	110	09/01→07/03						
2.5 TD	96	04/94→07/03			W1000001→; für Linkslenker; + ESP		24.2125-1740.3 010971	TRW Ø 25,4
2.5 V6	125	03/94→09/00			W1000001→; für Linkslenker; nicht für Sonderfahrzeuge; + ESP		24.2125-1740.3 010971	TRW Ø 25,4
2.6 V6	132	09/00→07/03			für Linkslenker; nicht für Sonderfahrzeuge; + ESP		24.2125-1740.3 010971	TRW Ø 25,4
3.2 V6	160	02/01→07/03						
3.0 V6	155	04/94→02/01			W1000001→; → 01/01; für Linkslenker; nicht für Sonderfahrzeuge; + ESP		24.2125-1740.3 010971	TRW Ø 25,4
OPEL - OMEGA B Caravan (V94) 03/94→07/03								
 Hauptbremszylinder								
2.0 DTi 16V	74	09/97→09/00			→ 08/00; für Linkslenker; + ESP		24.2125-1740.3 010971	TRW Ø 25,4
2.2 16V	106	09/99→07/03			für Linkslenker; + ESP		24.2125-1740.3 010971	TRW Ø 25,4
2.2 DTi 16V	81 - 88	09/00→07/03						
2.5 DTi	110	09/01→07/03						
2.5 TD	96	04/94→07/01			W1000001→; für Linkslenker; + ESP		24.2125-1740.3 010971	TRW Ø 25,4
2.5 V6	125	03/94→09/00			W1000001→; für Linkslenker; nicht für Sonderfahrzeuge; + ESP		24.2125-1740.3 010971	TRW Ø 25,4
2.6 V6	132	09/00→07/03			für Linkslenker; nicht für Sonderfahrzeuge; + ESP		24.2125-1740.3 010971	TRW Ø 25,4
3.2 V6	160	02/01→07/03						
3.0 V6	155	04/94→02/01			W1000001→; → 01/01; für Linkslenker; nicht für Sonderfahrzeuge; + ESP		24.2125-1740.3 010971	TRW Ø 25,4
OPEL - SIGNUM CC (Z03) 05/03→12/08								
 Hauptbremszylinder								
1.8	90	05/03→07/05			für Linkslenker; + ESP		24.2125-1732.3 010827	TRW Ø 25,4
1.9 CDTI	74 - 110	04/04→02/08						
2.0 DTi	74	05/03→04/04						
2.2 DTi	92	05/03→04/04						
3.0 V6 CDTI	130	05/03→07/05						
3.2 V6	155	05/03→07/05						
1.8	103	09/05→12/08			für Linkslenker; → 05/08; + ESP		24.2125-1732.3 010827	TRW Ø 25,4
2.0 Turbo	129	05/03→12/08						
2.2 direct	114	05/03→09/08						
3.0 V6 CDTI	135	09/05→12/08						













	kw					! #		
OPEL - TIGRA (S93) 07/94→12/00								
 Hauptbremszylinder								
1.4 16V	63 - 66	07/94→12/00		für Linkslenker; - ABS		24.2120-0702.3	010361	nicht für Delco Ø 20,6
				für Linkslenker; + ABS		24.2120-1714.3	010455	Ø 20,6
OPEL - TIGRA TwinTop (X04) 06/04→12/10								
 Hauptbremszylinder								
1.3 CDTI 1.4 1.8	51 66 92	06/04→12/10 06/04→12/10 06/04→12/10		- ESP; → 08/09		24.2123-1767.3	010844	BOS Ø 23,8
OPEL - VECTRA B (J96) 09/95→07/04								
 Bremskraftverstärker								
2.0 i 2.0 i 16V	82 100	10/95→04/02 09/95→06/00		für Linkslenker; → W1285446		03.7745-3003.4	300157	ATE Ø 8 / 7" pneumatisch
2.5 i V6 2.6 i V6	125 125	10/95→09/00 09/00→04/02		für Linkslenker		03.7745-3003.4	300157	ATE Ø 8 / 7" pneumatisch
 Hauptbremszylinder								
1.6 i 1.6 i 16V 1.8 i 16V	55 74 85 - 92	10/95→04/02 10/95→04/02 10/95→04/02		→ V1999999; für Linkslenker		24.2122-1724.3	010561	Ø 22,2
				→ V7999999; für Linkslenker		24.2122-1724.3	010561	Ø 22,2
				→ W1999999; für Rechtslenker		24.2122-1724.3	010561	Ø 22,2
2.0 DI 16V 2.0 DTI 16V	60 74	11/96→04/02 06/97→04/02		→ V5999999; für Linkslenker		24.2122-1724.3	010561	Ø 22,2
				→ W7999999; für Rechtslenker		24.2122-1724.3	010561	Ø 22,2
				→ W5999999; für Rechtslenker		24.2122-1724.3	010561	Ø 22,2
				W1000001→ W1999999; für Linkslenker		24.2123-1777.3	010943	Ø 23,8
				W7000001→ W7999999; für Linkslenker		24.2123-1777.3	010943	Ø 23,8
				W5000001→ W5999999; für Linkslenker		24.2123-1777.3	010943	Ø 23,8
2.0 i 2.0 i 16V 2.5 i V6	82 100 125	10/95→04/02 09/95→06/00 10/95→09/00		→ W1285446; für Linkslenker		03.2123-1622.3	010470	Ø 23,8
				→ W5276825; für Linkslenker		03.2123-1622.3	010470	Ø 23,8
				→ W7154258; für Linkslenker		03.2123-1622.3	010470	Ø 23,8
OPEL - VECTRA B Caravan (J96) 11/96→07/03								
 Bremskraftverstärker								
2.0 i 2.0 i 16V	82 85 - 100	11/96→02/02 11/96→07/03		für Linkslenker; → W1285446		03.7745-3003.4	300157	ATE Ø 8 / 7" pneumatisch
2.5 i V6 2.6 i V6	125 125	11/96→09/00 09/00→07/03		für Linkslenker → 04/02; für Linkslenker		03.7745-3003.4	300157	ATE Ø 8 / 7" pneumatisch
 Hauptbremszylinder								
1.6 i 1.6 i 16V 1.8 i 16V	55 74 85 - 92	11/96→06/00 11/96→07/02 11/96→07/03		→ V1999999; für Linkslenker		24.2122-1724.3	010561	Ø 22,2
				→ V7999999; für Linkslenker		24.2122-1724.3	010561	Ø 22,2
				→ W1999999; für Rechtslenker		24.2122-1724.3	010561	Ø 22,2
2.0 DI 16V 2.0 DTI 16V	60 74	11/96→06/00 06/97→07/03		→ V5999999; für Linkslenker		24.2122-1724.3	010561	Ø 22,2
				→ W7999999; für Rechtslenker		24.2122-1724.3	010561	Ø 22,2
				→ W5999999; für Rechtslenker		24.2122-1724.3	010561	Ø 22,2
				W7000001→ W7999999; für Linkslenker		24.2123-1777.3	010943	Ø 23,8
				W5000001→ W5999999; für Linkslenker		24.2123-1777.3	010943	Ø 23,8
				W1000001→ W1999999; für Linkslenker		24.2123-1777.3	010943	Ø 23,8
2.0 i 2.0 i 16V	82 85 - 100	11/96→02/02 11/96→07/03		→ W7154258; für Linkslenker		03.2123-1622.3	010470	Ø 23,8
				→ W1285446; für Linkslenker		03.2123-1622.3	010470	Ø 23,8
2.5 i V6	125	11/96→09/00		→ W5276825; für Linkslenker		03.2123-1622.3	010470	Ø 23,8
OPEL - VECTRA B CC (J96) 09/95→07/03								
 Bremskraftverstärker								
2.0 i 2.0 i 16V	82 85 - 100	10/95→02/02 09/95→07/03		für Linkslenker; → W1285446		03.7745-3003.4	300157	ATE Ø 8 / 7" pneumatisch
2.5 2.5 i V6 2.6 i V6	144 125 125	10/99→06/00 10/95→09/00 09/00→07/03		für Linkslenker → 04/02; für Linkslenker		03.7745-3003.4	300157	ATE Ø 8 / 7" pneumatisch
 Hauptbremszylinder								
1.6 i 1.6 i 16V 1.8 FlexFuel →	55 74 85	10/95→07/03 10/95→07/02 01/99→09/00		→ V1999999; für Linkslenker		24.2122-1724.3	010561	Ø 22,2
				→ V7999999; für Linkslenker		24.2122-1724.3	010561	Ø 22,2























	kw					! #		
OPEL - VECTRA B CC (J96) 09/95→07/03								
 Hauptbremszylinder								
1.8 i 16V	85 - 92	10/95→07/03		→ W1999999; für Rechtslenker		24.2122-1724.3 010561	Ø 22,2	
2.0 DI 16V	60	11/96→06/00		→ V5999999; für Linkslenker		24.2122-1724.3 010561	Ø 22,2	
2.0 DTI 16V	74	06/97→07/03		→ W7999999; für Rechtslenker		24.2122-1724.3 010561	Ø 22,2	
				→ W5999999; für Rechtslenker		24.2122-1724.3 010561	Ø 22,2	
				W7000001→ W7999999; für Linkslenker		24.2123-1777.3 010943	Ø 23,8	
				W5000001→ W5999999; für Linkslenker		24.2123-1777.3 010943	Ø 23,8	
				W1000001→ W1999999; für Linkslenker		24.2123-1777.3 010943	Ø 23,8	
2.0 i	82	10/95→02/02		→ W1285446; für Linkslenker		03.2123-1622.3 010470	Ø 23,8	
2.0 i 16V	85 - 100	09/95→07/03		→ W5276825; für Linkslenker		03.2123-1622.3 010470	Ø 23,8	
2.5	144	10/99→06/00		→ W7154258; für Linkslenker		03.2123-1622.3 010470	Ø 23,8	
2.5 i V6	125	10/95→09/00						
OPEL - VECTRA C (Z02) 04/02→01/09								
 Hauptbremszylinder								
1.6	77	08/05→08/08		für Linkslenker; + ESP		24.2125-1732.3 010827	TRW Ø 25,4	
1.6 16V	74	04/02→10/05						
1.8	81 - 103	04/02→08/08						
1.8 16V	90	04/02→09/08						
1.9 CDTI	74 - 110	04/04→08/08						
2.0 16V Turbo	129	03/03→08/08						
2.0 DTI 16V	74	04/02→08/06						
2.2 DGi	114	10/03→08/08						
2.2 DTI 16V	86 - 92	04/02→12/04						
3.0 CDTi	135	08/05→08/08						
3.0 CDTI	130	02/03→07/05						
3.2 V6	155	08/02→07/06						
1.9 CDTI	88	04/04→01/09		für Linkslenker; + ESP; → 10/08		24.2125-1732.3 010827	TRW Ø 25,4	
2.2 16V	108	04/02→12/08						
OPEL - VECTRA C Caravan (Z02) 10/03→01/09								
 Hauptbremszylinder								
1.6	77	12/05→08/08		06/06→; für Linkslenker; + ESP		24.2125-1732.3 010827	TRW Ø 25,4	
1.8	90 - 103	10/03→08/08		für Linkslenker; + ESP		24.2125-1732.3 010827	TRW Ø 25,4	
1.9 CDTI	74 - 110	04/04→08/08						
2.0 DTI	74	10/03→08/05						
2.0 Turbo	129	10/03→08/08						
2.2 direct	114	10/03→08/08						
2.2 DTI	92	10/03→12/05						
3.0 V6 CDTI	130 - 135	10/03→08/08						
3.2 V6	155	10/03→07/05						
1.9 CDTI	88	04/04→01/09		für Linkslenker; + ESP; → 10/08		24.2125-1732.3 010827	TRW Ø 25,4	
OPEL - VECTRA C CC (Z02) 08/02→01/09								
 Hauptbremszylinder								
1.6	74 - 77	08/05→08/08		für Linkslenker; + ESP		24.2125-1732.3 010827	TRW Ø 25,4	
1.8	103	08/05→08/08						
1.8 16V	81 - 90	08/02→09/08						
1.9 CDTI	74 - 110	04/04→08/08						
2.0 16V Turbo	129	03/03→08/08						
2.0 DTI 16V	74	08/02→08/05						
2.2 16V	108	08/02→08/08						
2.2 DGi	114	10/03→08/08						
2.2 DTI 16V	86 - 92	08/02→06/08						
3.0 CDTi	135	08/05→08/08						
3.0 CDTI	130	06/03→07/05						
3.2 V6	155	08/02→07/06						
1.9 CDTI	88	04/04→01/09		für Linkslenker; + ESP; → 10/08		24.2125-1732.3 010827	TRW Ø 25,4	
OPEL - VIVARO A Bus (X83) 08/01→10/15								
 Hauptbremszylinder								
1.9 DI	60	08/01→07/06		7V600001 / 7Y000001→; + ABS		24.2120-1748.3 010894	TRW Ø 20,6	
→				7V600001 / 7Y000001→; + ASR		24.2120-1753.3 010946	TRW Ø 20,6	







	kw			 	! #		
OPEL - VIVARO A Bus (X83) 08/01→10/15							
 Hauptbremszylinder							
1.9 DI	60	08/01→07/06		4V602168→ 6V699999; für Rechtslenker; - ASR		24.2125-1731.3 010826	TRW Ø 25,4
1.9 DTI	74	08/01→07/14		7V600001 / 7Y000001→; → 06/14; + ABS		24.2120-1748.3 010894	TRW Ø 20,6
				7V600001 / 7Y000001→; → 06/14; + ASR		24.2120-1753.3 010946	TRW Ø 20,6
				4V602168→ 6V699999; für Rechtslenker; - ASR		24.2125-1731.3 010826	TRW Ø 25,4
2.0 16V 2.5 CDTI 2.5 DTI	88 84 99	08/01→07/06 08/06→03/10 04/03→03/10		7V600001 / 7Y000001→; + ABS		24.2120-1748.3 010894	TRW Ø 20,6
				7V600001 / 7Y000001→; + ASR		24.2120-1753.3 010946	TRW Ø 20,6
				4V602168→ 6V699999; - ASR		24.2125-1731.3 010826	TRW Ø 25,4
2.0 CDTI 2.0 ECOTEC 2.5 CDTI	66 - 84 86 107	08/06→07/14 08/06→07/14 08/06→07/14		7V600001 / 7Y000001→; → 06/14; + ABS		24.2120-1748.3 010894	TRW Ø 20,6
				7V600001 / 7Y000001→; → 06/14; + ASR		24.2120-1753.3 010946	TRW Ø 20,6
				4V602168→ 6V699999; - ASR		24.2125-1731.3 010826	TRW Ø 25,4
OPEL - VIVARO A Kasten (X83) 08/01→10/15							
 Hauptbremszylinder							
1.9 DI	60	08/01→07/06		7V600001 / 7Y000001→; + ABS		24.2120-1748.3 010894	TRW Ø 20,6
				7V600001 / 7Y000001→; + ASR		24.2120-1753.3 010946	TRW Ø 20,6
				4V602168→ 6V699999; für Rechtslenker; - ASR		24.2125-1731.3 010826	TRW Ø 25,4
1.9 DTI	74	08/01→07/14		7V600001 / 7Y000001→; → 06/14; + ABS		24.2120-1748.3 010894	TRW Ø 20,6
				7V600001 / 7Y000001→; → 06/14; + ASR		24.2120-1753.3 010946	TRW Ø 20,6
				4V602168→ 6V699999; für Rechtslenker; - ASR		24.2125-1731.3 010826	TRW Ø 25,4
2.0 16V 2.5 CDTI 2.5 DTI	88 84 99	08/01→07/06 08/06→03/10 04/03→03/10		7V600001 / 7Y000001→; + ABS		24.2120-1748.3 010894	TRW Ø 20,6
				7V600001 / 7Y000001→; + ASR		24.2120-1753.3 010946	TRW Ø 20,6
				4V602168→ 6V699999; - ASR		24.2125-1731.3 010826	TRW Ø 25,4
2.0 CDTI 2.0 ECOTEC 2.5 CDTI	66 - 84 86 107	08/06→07/14 08/06→07/14 08/06→07/14		7V600001 / 7Y000001→; → 06/14; + ABS		24.2120-1748.3 010894	TRW Ø 20,6
				7V600001 / 7Y000001→; → 06/14; + ASR		24.2120-1753.3 010946	TRW Ø 20,6
				4V602168→ 6V699999; - ASR		24.2125-1731.3 010826	TRW Ø 25,4
OPEL - VIVARO A Pritsche/Fahrgestell (X83) 02/01→07/14							
 Hauptbremszylinder							
1.9 Di	60	08/01→07/14		7V600001 / 7Y000001→; → 06/14; + ABS		24.2120-1748.3 010894	TRW Ø 20,6
				7V600001 / 7Y000001→; → 06/14; + ASR		24.2120-1753.3 010946	TRW Ø 20,6
				4V602168→ 6V699999; für Rechtslenker; - ASR		24.2125-1731.3 010826	TRW Ø 25,4
1.9 DTI	74	02/01→12/10		7V600001 / 7Y000001→; + ABS		24.2120-1748.3 010894	TRW Ø 20,6
				7V600001 / 7Y000001→; + ASR		24.2120-1753.3 010946	TRW Ø 20,6
				4V602168→ 6V699999; für Rechtslenker; - ASR		24.2125-1731.3 010826	TRW Ø 25,4
2.0 16V 2.5 CDTI 2.5 DTI	88 84 99	01/02→07/06 08/06→03/10 04/03→03/10		7V600001 / 7Y000001→; + ABS		24.2120-1748.3 010894	TRW Ø 20,6
				7V600001 / 7Y000001→; + ASR		24.2120-1753.3 010946	TRW Ø 20,6
				4V602168→ 6V699999; - ASR		24.2125-1731.3 010826	TRW Ø 25,4
2.0 CDTI 2.0 ECOTEC 2.5 CDTI	66 - 84 86 107	01/06→07/14 08/06→07/14 08/06→07/14		7V600001 / 7Y000001→; → 06/14; + ABS		24.2120-1748.3 010894	TRW Ø 20,6
				7V600001 / 7Y000001→; → 06/14; + ASR		24.2120-1753.3 010946	TRW Ø 20,6
				4V602168→ 6V699999; - ASR		24.2125-1731.3 010826	TRW Ø 25,4
OPEL - ZAFIRA / ZAFIRA FAMILY B (A05) 07/05→05/19							
 Bremskraftverstärker							
1.6	77 - 85	07/05→04/15		für Linkslenker; + ESP		03.7863-7803.4 300237	ATE Ø 10" pneumatisch
1.6 CNG	69	07/05→04/15					
1.6 CNG Turbo	110	04/10→04/15					
1.6 FlexFuel	85	08/08→12/12					
1.7 CDTI	81 - 92	03/07→04/15					
1.8	88 - 103	07/05→04/15					
→							











	kw					! #		
OPEL - ZAFIRA / ZAFIRA FAMILY B (A05) 07/05→05/19								
 Bremskraftverstärker								
1.8 LPG 1.9 CDTI	103 74 - 110	07/09→04/15 07/05→04/15			für Linkslenker; + ESP		03.7863-7803.4 300237	ATE Ø 10" pneumatisch
2.0	147 - 177	07/05→12/10						
2.2	110	07/05→12/12						
 Hauptbremszylinder								
1.6	77	07/05→09/12			für Linkslenker; - ESP		03.4155-0153.3 010927	ATE Ø 25,4
1.6 CNG Turbo	110	04/10→04/15			für Linkslenker; + ESP		03.4155-0156.3 010862	ATE Ø 25,4
1.8	103	07/05→04/15						
1.8 LPG	103	07/09→04/15			→ 6G999999; für Rechtslenker		24.2125-1736.3 010904	TRW Ø 25,4
2.0	147 - 177	07/05→12/10			72000001→; für Rechtslenker		24.4125-1703.3 010907	TRW Ø 25,4
1.6	85	01/08→04/15			für Linkslenker; - ESP		03.4155-0153.3 010927	ATE Ø 25,4
1.6 CNG	69	07/05→04/15			für Linkslenker; + ESP		03.4155-0156.3 010862	ATE Ø 25,4
1.6 FlexFuel	85	08/08→12/12						
1.7 CDTI	81 - 92	03/07→04/15			für Linkslenker; - ESP		03.4155-0153.3 010927	ATE Ø 25,4
1.9 CDTI	74 -	07/05→04/15			für Rechtslenker		03.4155-0156.3 010862	ATE Ø 25,4
	110				für Linkslenker; + ESP		03.4155-0156.3 010862	ATE Ø 25,4
2.2	110	07/05→12/12						
1.8	88	06/13→04/15			für Linkslenker; - ESP		03.4155-0153.3 010927	ATE Ø 25,4
					für Linkslenker; + ESP		03.4155-0156.3 010862	ATE Ø 25,4
					für Rechtslenker		24.4125-1703.3 010907	TRW Ø 25,4
OPEL - ZAFIRA A Großraumlimousine (T98) 04/99→06/06								
 Hauptbremszylinder								
1.6	76	10/03→06/05			- ESP		24.2123-1734.3 010640	TRW Ø 23,8
1.6 16V	74	04/99→06/05			+ ESP		24.2123-1739.3 010661	Ø 23,8
1.6 CNG	71	09/01→06/05						
1.6 LPG	74 - 76	04/99→06/05						
1.8 16V	85 - 92	04/99→06/05						
2.0 DTI 16V	74	09/00→06/05						
2.0 OPC	141 - 147	09/01→06/05						
2.2 16V	108	09/00→06/05						
2.2 DTI 16V	86 - 92	01/02→06/05						
2.0 DI 16V	60	07/99→06/05			10/99→; - ESP		24.2123-1734.3 010640	TRW Ø 23,8
					10/99→; + ESP		24.2123-1739.3 010661	Ø 23,8
 Bremskraftregler								
1.6	76	10/03→06/05			- ABS		03.6583-0085.3 320238	ATE lastabhängig 8/3 4x
1.6 16V	74	04/99→06/05						
1.6 CNG	71	09/01→06/05						
1.6 LPG	74 - 76	04/99→06/05						
1.8 16V	85 - 92	04/99→06/05						
2.0 DTI 16V	74	09/00→06/05						
2.0 OPC	141 - 147	09/01→06/05						
2.2 16V	108	09/00→06/05						
2.2 DTI 16V	86 - 92	01/02→06/05						
2.0 DI 16V	60	07/99→06/05			10/99→; - ABS		03.6583-0085.3 320238	ATE lastabhängig 8/3 4x
OPEL - ZAFIRA B Kasten/Großraumlimousine (A05) 07/05→04/15								
 Bremskraftverstärker								
1.6 CNG Turbo VAN	110	02/09→04/15			für Linkslenker; + ESP		03.7863-7803.4 300237	ATE Ø 10" pneumatisch
1.6 CNG VAN	69	07/05→04/15						
1.7 CDTI VAN	81 - 92	01/08→04/15						
1.8 VAN	103	07/05→04/15						
1.9 CDTI VAN	88 - 110	07/05→04/15						
2.0 VAN	147	07/05→12/10						
2.2 DGi VAN	110	07/05→12/11						
 Hauptbremszylinder								
1.6 CNG Turbo VAN	110	02/09→04/15			für Linkslenker; - ESP		03.4155-0153.3 010927	ATE Ø 25,4
1.6 CNG VAN	69	07/05→04/15			für Linkslenker; + ESP		03.4155-0156.3 010862	ATE Ø 25,4
1.8 VAN	103	07/05→04/15			→ 6G999999; für Rechtslenker		24.2125-1736.3 010904	TRW Ø 25,4
→								

	kw					! #		
OPEL - ZAFIRA B Kasten/Großraumlimousine (A05) 07/05→04/15								
 Hauptbremszylinder								
1.9 CDTi VAN	88 - 110	07/05→04/15		72000001→; für Rechtslenker		24.4125-1703.3	010907	TRW Ø 25,4
2.0 VAN	147	07/05→12/10						
2.2 DGi VAN	110	07/05→12/11						
1.7 CDTi VAN	81 - 92	01/08→04/15		für Linkslenker; - ESP		03.4155-0153.3	010927	ATE Ø 25,4
				für Rechtslenker		03.4155-0156.3	010862	ATE Ø 25,4
				für Linkslenker; + ESP		03.4155-0156.3	010862	ATE Ø 25,4
OPEL - ZAFIRA TOURER C (P12) 10/11→								
 Bremskraftverstärker								
1.4	88 - 103	10/11→		11/11→; für Linkslenker		03.7858-0732.4	300272	ATE Ø 9 / 8" pneumatisch
1.4 LPG	103	10/11→						
1.6 CNG	110	10/11→						
1.8	85 - 103	10/11→						
2.0 CDTi	81	10/11→						
1.6	100 - 125	12/12→		für Linkslenker		03.7858-0732.4	300272	ATE Ø 9 / 8" pneumatisch
1.6 CDTi	88 - 99	07/14→						
1.6 SIDI	147	07/13→						
2.0 BiTurbo CDTi	143	01/13→						
2.0 CDTi	96 - 125	10/11→						
1.6 CDTi	100	02/13→		03/13→; für Linkslenker		03.7858-0732.4	300272	ATE Ø 9 / 8" pneumatisch
 Hauptbremszylinder								
1.4	88 - 103	10/11→		11/11→; für Linkslenker		03.2125-0421.3	010934	ATE Ø 25,4
1.4 LPG	103	10/11→		11/11→; für Rechtslenker		24.4155-0201.3	011125	ATE Ø 25,4 ohne Bremsflüssigkeitsbehälter
1.6 CNG	110	10/11→						
1.8	85 - 103	10/11→						
2.0 CDTi	81	10/11→						
1.6	100 - 125	12/12→		für Linkslenker		03.2125-0421.3	010934	ATE Ø 25,4
1.6 CDTi	88 - 99	07/14→		für Rechtslenker		24.4155-0201.3	011125	ATE Ø 25,4 ohne Bremsflüssigkeitsbehälter
1.6 SIDI	147	07/13→						
2.0 BiTurbo CDTi	143	01/13→						
2.0 CDTi	96 - 125	10/11→						
1.6 CDTi	100	02/13→		03/13→; für Linkslenker		03.2125-0421.3	010934	ATE Ø 25,4
				03/13→; für Rechtslenker		24.4155-0201.3	011125	ATE Ø 25,4 ohne Bremsflüssigkeitsbehälter
OPEL - ZAFIRA TOURER C VAN (P12) 10/11→								
 Bremskraftverstärker								
2.0 CDTi	81 - 121	01/12→		für Linkslenker		03.7858-0732.4	300272	ATE Ø 9 / 8" pneumatisch
 Hauptbremszylinder								
2.0 CDTi	81 - 121	01/12→		für Linkslenker		03.2125-0421.3	010934	ATE Ø 25,4
				für Rechtslenker		24.4155-0201.3	011125	ATE Ø 25,4 ohne Bremsflüssigkeitsbehälter
PEUGEOT - 106 II (1A_, 1C_) 04/96→05/05								
 Hauptbremszylinder								
1.0 i	37	04/96→03/01		→Orga 08787; - ABS		03.2120-4166.3	010452	ATE Ø 20,6
1.1 BiFuel	44	04/96→03/01				24.2120-1722.3	010544	Ø 20,6
1.1 i	40	01/97→03/01		Orga 08788→; - ABS		24.2119-1708.3	010543	BDX Ø 19
1.1 i	44	05/96→07/04		→Orga 08787; - ABS		03.2120-4166.3	010452	ATE Ø 20,6
				Orga 08788→; → 03/04; - ABS		24.2120-1722.3	010544	Ø 20,6
						24.2119-1708.3	010543	BDX Ø 19
1.4 i	55	05/96→07/04		→ 03/04; - ABS		24.2119-1708.3	010543	BDX Ø 19
1.5 D	40	05/96→03/01		- ABS		24.2119-1708.3	010543	BDX Ø 19
1.5 D	42	04/98→07/04		10/00→ 03/04; - ABS		24.2119-1708.3	010543	BDX Ø 19
1.6 i	74	05/96→01/01		- ABS		03.2120-4166.3	010452	ATE Ø 20,6
1.6 S16	88	04/98→09/01				24.2120-1722.3	010544	Ø 20,6
1.6 S16	87	05/96→07/04		→ 03/04; - ABS		03.2120-4166.3	010452	ATE Ø 20,6
→								

	kw					! #		
PEUGEOT - 106 II (1A_, 1C_) 04/96→05/05								
 Hauptbremszylinder								
1.6 S16	87	05/96→07/04			→ 03/04; - ABS		24.2120-1722.3 010544	Ø 20,6
Electric	20	04/96→07/04					03.2120-4166.3 010452	ATE Ø 20,6
							24.2120-1722.3 010544	Ø 20,6
PEUGEOT - 106 Van II Kasten/Schrägheck (1S_) 04/96→03/01								
 Hauptbremszylinder								
1.0	33	04/96→03/01			05/96→; →Orga 08787; - ABS		03.2120-4166.3 010452	ATE Ø 20,6
							24.2120-1722.3 010544	Ø 20,6
					Orga 08788→; - ABS		24.2119-1708.3 010543	BDX Ø 19
1.5 D	40 - 42	05/96→03/01			- ABS		24.2119-1708.3 010543	BDX Ø 19
Electric	20	04/96→03/01					03.2120-4166.3 010452	ATE Ø 20,6
							24.2120-1722.3 010544	Ø 20,6
PEUGEOT - 107 (PM_, PN_) 06/05→05/14								
 Hauptbremszylinder								
1.0	50	06/05→05/14			für Linkslenker; - DSC		24.4120-1701.3 010846	BOS Ø 20,6
1.4 HDi	40	06/05→05/14			für Linkslenker; + DSC		24.4120-1704.3 011042	Ø 20,6 ohne Bremsflüssigkeitsbehälter
					für Rechtslenker; + DSC		24.4120-1705.3 011051	Ø 20,6 ohne Bremsflüssigkeitsbehälter
PEUGEOT - 108 05/14→								
 Hauptbremszylinder								
1.0 VTi	51	05/14→			für Linkslenker; - ESP		24.4120-1712.3 011092	Ø 20,6 ohne Bremsflüssigkeitsbehälter
1.0 VTi 72	53	05/18→						
1.2	60	05/14→						
PEUGEOT - 206 CC (2D) 09/00→12/08								
 Bremskraftverstärker								
1.6	81	09/01→12/08			→Orga 09456; + ABS; Schaltgetriebe		03.7750-6234.4 300320	ATE Ø 9" pneumatisch
1.6 16V	80	09/00→12/07			Orga 09821→; → 01/07; - ABS; Schaltgetriebe		03.7750-6234.4 300320	ATE Ø 9" pneumatisch
					→Orga 09820; - ABS; Schaltgetriebe		03.7750-6234.4 300320	ATE Ø 9" pneumatisch
					Orga 09821→; → 01/07; - ABS; Automatikgetriebe		03.7750-6334.4 300321	ATE Ø 9" pneumatisch
					→Orga 09456; + ABS; Automatikgetriebe		03.7750-6334.4 300321	ATE Ø 9" pneumatisch
					→Orga 09820; - ABS; Automatikgetriebe		03.7750-6334.4 300321	ATE Ø 9" pneumatisch
					Orga 09741→; → 01/07; + ABS; Schaltgetriebe		03.7853-2604.4 300322	ATE Ø 9" pneumatisch
					09457→ 09740; + ABS; Schaltgetriebe		03.7853-2604.4 300322	ATE Ø 9" pneumatisch
					Orga 09741→; → 01/07; Automatikgetriebe; + ABS		03.7853-2704.4 300323	ATE Ø 9" pneumatisch
1.6 HDi 110	80	04/05→02/07			→ 01/07		03.7853-2604.4 300322	ATE Ø 9" pneumatisch
							03.7853-2704.4 300323	ATE Ø 9" pneumatisch
 Hauptbremszylinder								
1.6	81	09/01→12/08			→ 01/07; Schaltgetriebe; - ESP		03.2122-1351.3 010528	Ø 22,2
1.6 16V	80	09/00→12/07			→ 01/07; Schaltgetriebe; - ABS		03.2122-1356.3 010529	Ø 22,2
					→ 01/07; Schaltgetriebe; + ESP		03.2122-1942.3 010700	ATE Ø 22,2
					→ 01/07; Automatikgetriebe; - ABS		03.4122-0031.3 010611	ATE Ø 22,2
					→ 01/07; Automatikgetriebe; + ESP		03.4122-0054.3 010813	ATE Ø 22,2
1.6 HDi 110	80	04/05→02/07			→ 01/07; - ESP		03.2122-1351.3 010528	Ø 22,2
					→ 01/07; + ESP		03.2122-1942.3 010700	ATE Ø 22,2
							03.4122-0054.3 010813	ATE Ø 22,2
2.0 S16	100	09/00→12/07			→ 01/07; - ESP		03.2122-1351.3 010528	Ø 22,2
					→ 01/07; + ESP		03.2122-1942.3 010700	ATE Ø 22,2
PEUGEOT - 206 Schrägheck (2A/C) 08/98→12/12								
 Bremskraftverstärker								
1.0	52	06/01→12/05			→Orga 09456; + ABS		03.7750-6234.4 300320	ATE Ø 9" pneumatisch
1.1 i	44	09/98→02/07			Orga 09741→; + ABS		03.7853-2604.4 300322	ATE Ø 9" pneumatisch
					09457→ 09740; + ABS		03.7853-2604.4 300322	ATE Ø 9" pneumatisch
1.1	40	08/98→07/00			09/98→; →Orga 09456; + ABS		03.7750-6234.4 300320	ATE Ø 9" pneumatisch
→								

	kw			 	! #		
PEUGEOT - 206 Schrägheck (2A/C) 08/98→12/12							
Bremskraftverstärker							
1.1	40	08/98→07/00		Orga 09741→; + ABS	03.7853-2604.4	300322	ATE Ø 9" pneumatisch
				09457→ 09740; + ABS	03.7853-2604.4	300322	ATE Ø 9" pneumatisch
1.4 16V	65	10/03→02/08		- ABS	03.7750-6234.4	300320	ATE Ø 9" pneumatisch
					03.7853-2604.4	300322	ATE Ø 9" pneumatisch
1.4 CNG	55	05/06→09/07		- ABS; Schaltgetriebe	03.7750-6134.4	300319	ATE Ø 9" pneumatisch
1.4 LPG	55	05/06→09/07		- ABS; Automatikgetriebe	03.7750-6334.4	300321	ATE Ø 9" pneumatisch
				+ ABS; Schaltgetriebe	03.7853-2604.4	300322	ATE Ø 9" pneumatisch
				+ ABS; Automatikgetriebe	03.7853-2704.4	300323	ATE Ø 9" pneumatisch
1.4 Flex	60	01/06→11/09		→Orga 09820; Schaltgetriebe; - ABS	03.7750-6134.4	300319	ATE Ø 9" pneumatisch
1.4 i	55	09/98→12/12		→Orga 09456; Schaltgetriebe; + ABS	03.7750-6234.4	300320	ATE Ø 9" pneumatisch
				→Orga 09820; Automatikgetriebe; - ABS	03.7750-6334.4	300321	ATE Ø 9" pneumatisch
				→Orga 09456; Automatikgetriebe; + ABS	03.7750-6334.4	300321	ATE Ø 9" pneumatisch
				Orga 09821→; → 02/09; Automatikgetriebe; - ABS	03.7750-6334.4	300321	ATE Ø 9" pneumatisch
				09457→ 09740; Schaltgetriebe; + ABS	03.7853-2604.4	300322	ATE Ø 9" pneumatisch
				Orga 09741→; → 02/09; Schaltgetriebe	03.7853-2604.4	300322	ATE Ø 9" pneumatisch
				Orga 09741→; → 02/09; Automatikgetriebe	03.7853-2704.4	300323	ATE Ø 9" pneumatisch
1.4 HDi	51	09/02→02/07		→Orga 09820; - ABS	03.7750-6134.4	300319	ATE Ø 9" pneumatisch
				→Orga 09456; + ABS	03.7750-6234.4	300320	ATE Ø 9" pneumatisch
				Orga 09821→	03.7853-2604.4	300322	ATE Ø 9" pneumatisch
				09457→ 09740; + ABS	03.7853-2604.4	300322	ATE Ø 9" pneumatisch
1.4 HDi eco 70	50	09/01→04/09		→Orga 09820; - ABS	03.7750-6134.4	300319	ATE Ø 9" pneumatisch
				→Orga 09456; + ABS	03.7750-6234.4	300320	ATE Ø 9" pneumatisch
				Orga 09821→; → 02/09	03.7853-2604.4	300322	ATE Ø 9" pneumatisch
				09457→ 09740; + ABS	03.7853-2604.4	300322	ATE Ø 9" pneumatisch
1.6	81	05/05→07/08		→Orga 09456; Schaltgetriebe; + ABS	03.7750-6234.4	300320	ATE Ø 9" pneumatisch
1.6 16V	79 - 80	07/00→04/09		09821→ 10996; - ABS; Schaltgetriebe	03.7750-6234.4	300320	ATE Ø 9" pneumatisch
1.6 BiFuel	80	07/00→04/09		→Orga 09820; Schaltgetriebe; + ABS	03.7750-6234.4	300320	ATE Ø 9" pneumatisch
1.6 Flex	83	05/05→07/08		→Orga 09456; Automatikgetriebe; + ABS	03.7750-6334.4	300321	ATE Ø 9" pneumatisch
				→Orga 09820; Automatikgetriebe; - ABS	03.7750-6334.4	300321	ATE Ø 9" pneumatisch
				09821→ 10996; Automatikgetriebe; - ABS	03.7750-6334.4	300321	ATE Ø 9" pneumatisch
				09741→ 10996; Schaltgetriebe	03.7853-2604.4	300322	ATE Ø 9" pneumatisch
				09457→ 09740; Schaltgetriebe; + ABS	03.7853-2604.4	300322	ATE Ø 9" pneumatisch
				09741→ 10996; Automatikgetriebe; + ABS	03.7853-2704.4	300323	ATE Ø 9" pneumatisch
1.6 8V	66	05/99→10/03		→ 12/00; Schaltgetriebe; - ABS	03.7750-6134.4	300319	ATE Ø 9" pneumatisch
				→ 12/00; Schaltgetriebe; + ABS	03.7750-6234.4	300320	ATE Ø 9" pneumatisch
				→ 12/00; Automatikgetriebe	03.7750-6334.4	300321	ATE Ø 9" pneumatisch
1.6 HDi 110	80	05/04→02/07		+ ABS	03.7853-2604.4	300322	ATE Ø 9" pneumatisch
					03.7853-2704.4	300323	ATE Ø 9" pneumatisch
1.6 i	65	09/98→12/00		- ABS; Schaltgetriebe	03.7750-6134.4	300319	ATE Ø 9" pneumatisch
				Schaltgetriebe; + ABS	03.7750-6234.4	300320	ATE Ø 9" pneumatisch
				Automatikgetriebe	03.7750-6334.4	300321	ATE Ø 9" pneumatisch
1.9 D	51	09/98→11/01			03.7750-6134.4	300319	ATE Ø 9" pneumatisch
				→Orga 09456; + ABS	03.7750-6234.4	300320	ATE Ø 9" pneumatisch
					03.7750-6334.4	300321	ATE Ø 9" pneumatisch
				Orga 09457→; + ABS	03.7853-2604.4	300322	ATE Ø 9" pneumatisch
2.0 HDi 90	66	12/99→09/09		→Orga 09456	03.7750-6234.4	300320	ATE Ø 9" pneumatisch
					03.7750-6334.4	300321	ATE Ø 9" pneumatisch
				→Orga 09820	03.7750-6234.4	300320	ATE Ø 9" pneumatisch
					03.7750-6334.4	300321	ATE Ø 9" pneumatisch
				Orga 09821→; → 02/09	03.7750-6234.4	300320	ATE Ø 9" pneumatisch
					03.7750-6334.4	300321	ATE Ø 9" pneumatisch
				09457→ 09820; + ABS	03.7853-2604.4	300322	ATE Ø 9" pneumatisch
				Orga 09821→; → 02/09; + ABS	03.7853-2604.4	300322	ATE Ø 9" pneumatisch
					03.7853-2704.4	300323	ATE Ø 9" pneumatisch
Hauptbremszylinder							
1.0	52	06/01→12/05		- ABS	03.2120-4321.3	010525	ATE Ø 20,6
→							

	kw			 	! #		
PEUGEOT - 206 Schrägheck (2A/C) 08/98→12/12							
Hauptbremszylinder							
1.1 i	44	09/98→02/07		+ ABS		03.2122-1351.3 010528	Ø 22,2
						24.2120-1737.3 010757	Ø 20,6
1.1	40	08/98→07/00		09/98→; - ABS		03.2120-4321.3 010525	ATE Ø 20,6
				09/98→; + ABS		03.2122-1351.3 010528	Ø 22,2
				09/98→		24.2120-1737.3 010757	Ø 20,6
1.4 16V	65	10/03→02/08		- ESP		03.2122-1351.3 010528	Ø 22,2
				- ABS		03.2122-1356.3 010529	Ø 22,2
				+ ESP		03.2122-1942.3 010700	ATE Ø 22,2
1.4 CNG	55	05/06→09/07		Schaltgetriebe; - ABS		03.2120-4321.3 010525	ATE Ø 20,6
1.4 Flex	60	01/06→11/09		Schaltgetriebe; + ABS		03.2122-1351.3 010528	Ø 22,2
1.4 LPG	55	05/06→09/07		Automatikgetriebe; - ABS		03.4122-0031.3 010611	ATE Ø 22,2
1.6 i	65	09/98→12/00		Schaltgetriebe		24.2120-1737.3 010757	Ø 20,6
1.4 HDi	51	09/02→02/07		- ABS		03.2120-4321.3 010525	ATE Ø 20,6
				- ESP		03.2122-1351.3 010528	Ø 22,2
				+ ESP		03.2122-1942.3 010700	ATE Ø 22,2
						24.2120-1737.3 010757	Ø 20,6
1.4 HDi eco 70	50	09/01→04/09		→ 02/09; - ABS		03.2120-4321.3 010525	ATE Ø 20,6
				→ 02/09; - ESP		03.2122-1351.3 010528	Ø 22,2
				→ 02/09; + ESP		03.2122-1942.3 010700	ATE Ø 22,2
				→ 02/09		24.2120-1737.3 010757	Ø 20,6
1.4 i	55	09/98→12/12		→ 02/09; Schaltgetriebe; - ABS		03.2120-4321.3 010525	ATE Ø 20,6
				→ 02/09; Schaltgetriebe; + ABS		03.2122-1351.3 010528	Ø 22,2
				→ 02/09; Automatikgetriebe; - ABS		03.4122-0031.3 010611	ATE Ø 22,2
				→ 02/09; Schaltgetriebe		24.2120-1737.3 010757	Ø 20,6
1.6	81	05/05→07/08		Schaltgetriebe; + ABS		03.2122-1351.3 010528	Ø 22,2
1.6 16V	79	06/01→04/09		Schaltgetriebe; - ESP		03.2122-1351.3 010528	Ø 22,2
1.6 Flex	83	05/05→07/08		Schaltgetriebe; - ABS		03.2122-1356.3 010529	Ø 22,2
				Schaltgetriebe; + ESP		03.2122-1942.3 010700	ATE Ø 22,2
				Automatikgetriebe; - ABS		03.4122-0031.3 010611	ATE Ø 22,2
				Automatikgetriebe; + ESP		03.4122-0054.3 010813	ATE Ø 22,2
1.6 16V	80	07/00→04/09		→ 02/09; Schaltgetriebe; + ABS		03.2122-1351.3 010528	Ø 22,2
1.6 BiFuel	80	07/00→04/09		→ 02/09; Schaltgetriebe; - ESP		03.2122-1351.3 010528	Ø 22,2
				→ 02/09; Schaltgetriebe; - ABS		03.2122-1356.3 010529	Ø 22,2
				→ 02/09; Schaltgetriebe; + ESP		03.2122-1942.3 010700	ATE Ø 22,2
				→ 02/09; Automatikgetriebe; - ABS		03.4122-0031.3 010611	ATE Ø 22,2
				→ 02/09; Automatikgetriebe; + ESP		03.4122-0054.3 010813	ATE Ø 22,2
1.6 8V	66	05/99→10/03		→ 12/00; Schaltgetriebe; - ABS		03.2120-4321.3 010525	ATE Ø 20,6
				→ 12/00; Schaltgetriebe; + ABS		03.2122-1351.3 010528	Ø 22,2
				→ 12/00; Automatikgetriebe; - ABS		03.4122-0031.3 010611	ATE Ø 22,2
				→ 12/00; Schaltgetriebe		24.2120-1737.3 010757	Ø 20,6
1.6 HDi 110	80	05/04→02/07		- ESP		03.2122-1351.3 010528	Ø 22,2
				+ ESP		03.2122-1942.3 010700	ATE Ø 22,2
						03.4122-0054.3 010813	ATE Ø 22,2
1.9 D	51	09/98→11/01		- ABS		03.2120-4321.3 010525	ATE Ø 20,6
				+ ABS		03.4122-0031.3 010611	ATE Ø 22,2
						24.2120-1737.3 010757	Ø 20,6
2.0 HDI 90	66	12/99→09/09		→ 02/09; - ESP		03.2122-1351.3 010528	Ø 22,2
				→ 02/09; - ABS		03.2122-1356.3 010529	Ø 22,2
				→ 02/09; + ESP		03.4122-0031.3 010611	ATE Ø 22,2
						03.2122-1942.3 010700	ATE Ø 22,2
						03.4122-0054.3 010813	ATE Ø 22,2
2.0 RC	130	07/03→12/07				03.2122-1942.3 010700	ATE Ø 22,2
2.0 S16	99	04/99→10/00		- ESP		03.2122-1351.3 010528	Ø 22,2
				+ ESP		03.2122-1942.3 010700	ATE Ø 22,2
2.0 S16	100	06/99→12/07		10/00→ 02/07; - ESP		03.2122-1351.3 010528	Ø 22,2
				10/00→ 02/07; + ESP		03.2122-1942.3 010700	ATE Ø 22,2

	kw			 	! #		
PEUGEOT - 206 Stufenheck 03/07→							
 Bremskraftverstärker							
1.4	55	03/07→		→ 02/09; - ABS; Schaltgetriebe	03.7750-6134.4	300319	ATE Ø 9" pneumatisch
				→ 02/09; - ABS; Automatikgetriebe	03.7750-6334.4	300321	ATE Ø 9" pneumatisch
				→ 02/09; + ABS; Schaltgetriebe	03.7853-2604.4	300322	ATE Ø 9" pneumatisch
				→ 02/09; + ABS; Automatikgetriebe	03.7853-2704.4	300323	ATE Ø 9" pneumatisch
1.4 HDi eco 70	50	09/08→		→ 02/09	03.7853-2604.4	300322	ATE Ø 9" pneumatisch
1.6 16V	80	03/07→		→Orga 09456; Schaltgetriebe; + ABS	03.7750-6234.4	300320	ATE Ø 9" pneumatisch
				09821→ 10996; - ABS; Schaltgetriebe	03.7750-6234.4	300320	ATE Ø 9" pneumatisch
				→Orga 09820; Schaltgetriebe; + ABS	03.7750-6234.4	300320	ATE Ø 9" pneumatisch
				→Orga 09820; Automatikgetriebe; - ABS	03.7750-6334.4	300321	ATE Ø 9" pneumatisch
				→Orga 09456; Automatikgetriebe; + ABS	03.7750-6334.4	300321	ATE Ø 9" pneumatisch
				09821→ 10996; Automatikgetriebe; - ABS	03.7750-6334.4	300321	ATE Ø 9" pneumatisch
				09741→ 10996; Schaltgetriebe	03.7853-2604.4	300322	ATE Ø 9" pneumatisch
				09457→ 09740; Schaltgetriebe; + ABS	03.7853-2604.4	300322	ATE Ø 9" pneumatisch
				09741→ 10996; Automatikgetriebe; + ABS	03.7853-2704.4	300323	ATE Ø 9" pneumatisch
 Hauptbremszylinder							
1.4	55	03/07→		→ 02/09; Schaltgetriebe; - ABS	03.2120-4321.3	010525	ATE Ø 20,6
				→ 02/09; Schaltgetriebe; + ABS	03.2122-1351.3	010528	Ø 22,2
				→ 02/09; Automatikgetriebe; - ABS	03.4122-0031.3	010611	ATE Ø 22,2
				→ 02/09; Schaltgetriebe	24.2120-1737.3	010757	Ø 20,6
1.4 HDi eco 70	50	09/08→		→ 02/09; - ABS	03.2120-4321.3	010525	ATE Ø 20,6
				→ 02/09; - ESP	03.2122-1351.3	010528	Ø 22,2
				→ 02/09; + ABS	03.2122-1351.3	010528	Ø 22,2
				→ 02/09; + ESP	03.2122-1942.3	010700	ATE Ø 22,2
				→ 02/09	24.2120-1737.3	010757	Ø 20,6
1.6 16V	80	03/07→		→ 02/09; Schaltgetriebe; - ESP	03.2122-1351.3	010528	Ø 22,2
				→ 02/09; Schaltgetriebe; + ABS	03.2122-1351.3	010528	Ø 22,2
				→ 02/09; Schaltgetriebe; - ABS	03.2122-1356.3	010529	Ø 22,2
				→ 02/09; Schaltgetriebe; + ESP	03.2122-1942.3	010700	ATE Ø 22,2
				→ 02/09; Automatikgetriebe; - ABS	03.4122-0031.3	010611	ATE Ø 22,2
				→ 02/09; Automatikgetriebe; + ESP	03.4122-0054.3	010813	ATE Ø 22,2
PEUGEOT - 206 SW (2E/K) 07/02→							
 Bremskraftverstärker							
1.1	44	07/02→02/07		→Orga 09456; + ABS	03.7750-6234.4	300320	ATE Ø 9" pneumatisch
				Orga 09741→; + ABS	03.7853-2604.4	300322	ATE Ø 9" pneumatisch
				09457→ 09740; + ABS	03.7853-2604.4	300322	ATE Ø 9" pneumatisch
1.4 1.4 Flex 1.4 LPG	55 59 55	07/02→02/07 01/06→07/08 07/02→02/07		→Orga 09820; Schaltgetriebe; - ABS	03.7750-6134.4	300319	ATE Ø 9" pneumatisch
				→Orga 09456; Schaltgetriebe; + ABS	03.7750-6234.4	300320	ATE Ø 9" pneumatisch
				→Orga 09456; + ABS; Automatikgetriebe	03.7750-6334.4	300321	ATE Ø 9" pneumatisch
				→Orga 09820; - ABS; Automatikgetriebe	03.7750-6334.4	300321	ATE Ø 9" pneumatisch
				Orga 09821→; - ABS; Automatikgetriebe	03.7750-6334.4	300321	ATE Ø 9" pneumatisch
				09457→ 09740; Schaltgetriebe; + ABS	03.7853-2604.4	300322	ATE Ø 9" pneumatisch
				Orga 09741→; + ABS; Schaltgetriebe	03.7853-2604.4	300322	ATE Ø 9" pneumatisch
				Orga 09741→; + ABS; Automatikgetriebe	03.7853-2704.4	300323	ATE Ø 9" pneumatisch
1.4 16V	65	10/03→		→ 05/07; - ABS	03.7750-6134.4	300319	ATE Ø 9" pneumatisch
				→ 05/07; + ABS	03.7853-2604.4	300322	ATE Ø 9" pneumatisch
1.4 HDi	50	07/02→02/07		→Orga 09820; - ABS	03.7750-6134.4	300319	ATE Ø 9" pneumatisch
				→Orga 09456; + ABS	03.7750-6234.4	300320	ATE Ø 9" pneumatisch
				09457→ 09820; + ABS	03.7853-2604.4	300322	ATE Ø 9" pneumatisch
				Orga 09821→; + ABS	03.7853-2604.4	300322	ATE Ø 9" pneumatisch
1.6 1.6 16V	81 80	05/05→07/08 07/02→		→Orga 09820; Schaltgetriebe; + ABS	03.7750-6234.4	300320	ATE Ø 9" pneumatisch
				Orga 09821→; → 05/07; Schaltgetriebe; - ABS	03.7750-6234.4	300320	ATE Ø 9" pneumatisch
				→Orga 09456; Schaltgetriebe; + ABS	03.7750-6234.4	300320	ATE Ø 9" pneumatisch
				Orga 09821→; → 05/07; - ABS; Automatikgetriebe	03.7750-6334.4	300321	ATE Ø 9" pneumatisch
				→Orga 09456; + ABS; Automatikgetriebe	03.7750-6334.4	300321	ATE Ø 9" pneumatisch
				→Orga 09820; - ABS; Automatikgetriebe	03.7750-6334.4	300321	ATE Ø 9" pneumatisch
→							















PEUGEOT - 206 SW (2E/K) 07/02→















Bremskraftverstärker











1.6 1.6 16V	81 80	05/05→07/08 07/02→	Orga 09741→; → 05/07; + ABS; Schaltgetriebe	03.7853-2604.4	300322	ATE Ø 9" pneumatisch
			09457→ 09740; Schaltgetriebe; + ABS	03.7853-2604.4	300322	ATE Ø 9" pneumatisch
			Orga 09741→; → 05/07; + ABS; Automatikgetriebe	03.7853-2704.4	300323	ATE Ø 9" pneumatisch
1.6 Flex 1.6 LPG	81 - 83 80	05/05→07/08 07/02→02/07	→Orga 09820; Schaltgetriebe; + ABS	03.7750-6234.4	300320	ATE Ø 9" pneumatisch
			Orga 09821→; Schaltgetriebe; - ABS	03.7750-6234.4	300320	ATE Ø 9" pneumatisch
			→Orga 09456; Schaltgetriebe; + ABS	03.7750-6234.4	300320	ATE Ø 9" pneumatisch
			→Orga 09456; + ABS; Automatikgetriebe	03.7750-6334.4	300321	ATE Ø 9" pneumatisch
			→Orga 09820; - ABS; Automatikgetriebe	03.7750-6334.4	300321	ATE Ø 9" pneumatisch
			Orga 09821→; - ABS; Automatikgetriebe	03.7750-6334.4	300321	ATE Ø 9" pneumatisch
			09457→ 09740; Schaltgetriebe; + ABS	03.7853-2604.4	300322	ATE Ø 9" pneumatisch
			Orga 09741→; + ABS; Schaltgetriebe	03.7853-2604.4	300322	ATE Ø 9" pneumatisch
1.6 HDi 110	80	05/04→	→ 05/07; + ABS	03.7853-2604.4	300322	ATE Ø 9" pneumatisch
				03.7853-2704.4	300323	ATE Ø 9" pneumatisch
2.0 HDi	66	07/02→02/07	→Orga 09456; + ABS	03.7750-6234.4	300320	ATE Ø 9" pneumatisch
				03.7750-6334.4	300321	ATE Ø 9" pneumatisch
			Orga 09821→; - ABS	03.7750-6234.4	300320	ATE Ø 9" pneumatisch
				03.7750-6334.4	300321	ATE Ø 9" pneumatisch
			→Orga 09820; - ABS	03.7750-6234.4	300320	ATE Ø 9" pneumatisch
	03.7750-6334.4	300321	ATE Ø 9" pneumatisch			
			09457→ 09820; + ABS	03.7853-2604.4	300322	ATE Ø 9" pneumatisch
			Orga 09821→; + ABS	03.7853-2604.4	300322	ATE Ø 9" pneumatisch
				03.7853-2704.4	300323	ATE Ø 9" pneumatisch







Hauptbremszylinder







1.1	44	07/02→02/07	- ABS	03.2120-4321.3	010525	ATE Ø 20,6
			+ ABS	24.2120-1737.3	010757	Ø 20,6
1.4 1.4 Flex 1.4 LPG	55 59 55	07/02→02/07 01/06→07/08 07/02→02/07	Schaltgetriebe; - ABS	03.2120-4321.3	010525	ATE Ø 20,6
				24.2120-1737.3	010757	Ø 20,6
			Schaltgetriebe; + ABS	03.2122-1351.3	010528	Ø 22,2
			Automatikgetriebe; - ABS	03.4122-0031.3	010611	ATE Ø 22,2
1.4 16V	65	10/03→	Automatikgetriebe; + ESP	03.4122-0054.3	010813	ATE Ø 22,2
			→ 05/07; - ESP	03.2122-1351.3	010528	Ø 22,2
			→ 05/07; - ABS	03.2122-1356.3	010529	Ø 22,2
1.4 HDi	50	07/02→02/07	→ 05/07; + ESP	03.2122-1942.3	010700	ATE Ø 22,2
			- ABS	03.2120-4321.3	010525	ATE Ø 20,6
				24.2120-1737.3	010757	Ø 20,6
			- ESP	03.2122-1351.3	010528	Ø 22,2
			+ ESP	03.2122-1942.3	010700	ATE Ø 22,2
1.6 1.6 16V	81 80	05/05→07/08 07/02→	→ 05/07; Schaltgetriebe; - ESP	03.2122-1351.3	010528	Ø 22,2
			→ 05/07; Schaltgetriebe; - ABS	03.2122-1356.3	010529	Ø 22,2
			→ 05/07; Schaltgetriebe; + ESP	03.2122-1942.3	010700	ATE Ø 22,2
			→ 05/07; Automatikgetriebe; - ABS	03.4122-0031.3	010611	ATE Ø 22,2
			→ 05/07; Automatikgetriebe; + ESP	03.4122-0054.3	010813	ATE Ø 22,2
1.6 Flex 1.6 LPG	81 - 83 80	05/05→07/08 07/02→02/07	Schaltgetriebe; - ESP	03.2122-1351.3	010528	Ø 22,2
			Schaltgetriebe; - ABS	03.2122-1356.3	010529	Ø 22,2
			Schaltgetriebe; + ESP	03.2122-1942.3	010700	ATE Ø 22,2
			Automatikgetriebe; - ABS	03.4122-0031.3	010611	ATE Ø 22,2
			Automatikgetriebe; + ESP	03.4122-0054.3	010813	ATE Ø 22,2
1.6 HDi 110	80	05/04→	→ 05/07; - ESP	03.2122-1351.3	010528	Ø 22,2
			→ 05/07; + ESP	03.2122-1942.3	010700	ATE Ø 22,2
2.0 16V	100	07/02→02/07	- ESP	03.4122-0054.3	010813	ATE Ø 22,2
			+ ESP	03.2122-1351.3	010528	Ø 22,2
2.0 HDi	66	07/02→02/07	- ESP	03.2122-1942.3	010700	ATE Ø 22,2
			- ABS	03.2122-1351.3	010528	Ø 22,2
				03.2122-1356.3	010529	Ø 22,2
			+ ESP	03.4122-0031.3	010611	ATE Ø 22,2
				03.2122-1942.3	010700	ATE Ø 22,2













	kw					! #		
PEUGEOT - 206 SW (2E/K) 07/02→								
 Hauptbremszylinder								
2.0 HDi	66	07/02→02/07		+ ESP			03.4122-0054.3 010813	ATE Ø 22,2
PEUGEOT - 206 Van 04/99→03/09								
 Bremskraftverstärker								
1.1	44	09/02→02/07		→Orga 09456; + ABS		03.7750-6234.4 300320	ATE Ø 9" pneumatisch	
				Orga 09741→; + ABS		03.7853-2604.4 300322	ATE Ø 9" pneumatisch	
				09457→ 09740; + ABS		03.7853-2604.4 300322	ATE Ø 9" pneumatisch	
1.4 HDi	50	09/01→03/09		→Orga 09820; - ABS		03.7750-6134.4 300319	ATE Ø 9" pneumatisch	
				→Orga 09456; + ABS		03.7750-6234.4 300320	ATE Ø 9" pneumatisch	
				Orga 09821→; → 02/09		03.7853-2604.4 300322	ATE Ø 9" pneumatisch	
				09457→ 09740; + ABS		03.7853-2604.4 300322	ATE Ø 9" pneumatisch	
1.9 D	51	04/99→05/07				03.7750-6134.4 300319	ATE Ø 9" pneumatisch	
						03.7750-6334.4 300321	ATE Ø 9" pneumatisch	
				→Orga 09456; + ABS		03.7750-6234.4 300320	ATE Ø 9" pneumatisch	
						03.7750-6334.4 300321	ATE Ø 9" pneumatisch	
				Orga 09457→; + ABS		03.7853-2604.4 300322	ATE Ø 9" pneumatisch	
 Hauptbremszylinder								
1.1	44	09/02→02/07		- ABS		03.2120-4321.3 010525	ATE Ø 20,6	
				+ ABS		03.2122-1351.3 010528	Ø 22,2	
						24.2120-1737.3 010757	Ø 20,6	
1.4 HDi	50	09/01→03/09		→ 02/09; - ABS		03.2120-4321.3 010525	ATE Ø 20,6	
				→ 02/09; - ESP		03.2122-1351.3 010528	Ø 22,2	
				→ 02/09; + ESP		03.2122-1942.3 010700	ATE Ø 22,2	
				→ 02/09		24.2120-1737.3 010757	Ø 20,6	
1.9 D	51	04/99→05/07		- ABS		03.2120-4321.3 010525	ATE Ø 20,6	
						03.4122-0031.3 010611	ATE Ø 22,2	
				+ ABS		03.2122-1351.3 010528	Ø 22,2	
						24.2120-1737.3 010757	Ø 20,6	
PEUGEOT - 206+ (2L_, 2M_) 01/09→08/13								
 Bremskraftverstärker								
1.1	44	01/09→06/13		→ 05/13; - ABS		03.7750-6134.4 300319	ATE Ø 9" pneumatisch	
1.1 LPG	44	04/09→06/13						
1.4 HDi eco 70	50	01/09→06/13		→ 05/13; + ABS		03.7853-2604.4 300322	ATE Ø 9" pneumatisch	
1.4 i	54 - 55	01/09→08/13						
 Hauptbremszylinder								
1.1	44	01/09→06/13		→ 05/13; - ABS		03.2120-4321.3 010525	ATE Ø 20,6	
1.1 LPG	44	04/09→06/13				24.2120-1737.3 010757	Ø 20,6	
1.4 HDi eco 70	50	01/09→06/13						
1.4 i	54 - 55	01/09→08/13		→ 05/13; + ABS		03.2122-1351.3 010528	Ø 22,2	
				→ 05/13; + ESP		03.2122-1942.3 010700	ATE Ø 22,2	
PEUGEOT - 207 (WA_, WC_) 02/06→12/15								
 Bremskraftverstärker								
2.0 HDi	66	10/08→12/12		+ ABS		03.7853-2604.4 300322	ATE Ø 9" pneumatisch	
 Hauptbremszylinder								
1.4	54 - 55	04/06→12/15		→ 06/12; + ESP		24.4122-1703.3 010843	TRW Ø 22,2	
1.4 16V	65 - 72	02/06→10/13		→ 06/12; - ESP		24.4122-1704.3 010847	TRW Ø 22,2	
1.4 Bioflex	60	08/08→12/14						
1.4 HDi	50 - 52	02/06→12/15						
1.6	81	08/08→12/13						
1.6 16V	79 - 80	02/06→12/13						
1.6 Flex	83	08/08→12/13						
1.6 HDi	66	02/06→10/13						
1.4 16V	70	06/07→10/13		08/07→ 06/12; + ESP		24.4122-1703.3 010843	TRW Ø 22,2	
				08/07→ 06/12; - ESP		24.4122-1704.3 010847	TRW Ø 22,2	
1.4 BiFuel	54	08/07→12/13		+ ESP		24.4122-1703.3 010843	TRW Ø 22,2	
				- ESP		24.4122-1704.3 010847	TRW Ø 22,2	
1.6 16V RC	128	02/07→12/12		→ 06/12; + ESP		24.4123-1704.3 010828	TRW Ø 23,8	













	kw					! #		
PEUGEOT - 207 (WA_, WC_) 02/06→12/15								
 Hauptbremszylinder								
1.6 16V Turbo 1.6 16V VTi 1.6 HDi 1.6 HDi 110	110 88 68 - 80 82	02/06→10/13 02/07→12/12 02/06→10/13 08/09→12/12			→ 06/12; - ESP		24.4123-1705.3 010832	TRW Ø 23,8
1.6 16V Turbo	115	10/09→12/12			01/10→06/12; + ESP		24.4123-1704.3 010828	TRW Ø 23,8
					01/10→06/12; - ESP		24.4123-1705.3 010832	TRW Ø 23,8
1.6 16V VTi	81	09/08→12/12			+ ESP		24.4123-1704.3 010828	TRW Ø 23,8
					- ESP		24.4123-1705.3 010832	TRW Ø 23,8
2.0 HDi	66	10/08→12/12			+ ABS		03.2122-1351.3 010528	Ø 22,2
PEUGEOT - 207 CC (WD_) 02/07→01/15								
 Hauptbremszylinder								
1.6 16V 1.6 16V Turbo	88 110 - 115	02/07→10/13 02/07→12/13			+ ESP		24.4123-1704.3 010828	TRW Ø 23,8
1.6 HDi	80 - 82	02/07→01/15			- ESP		24.4123-1705.3 010832	TRW Ø 23,8
PEUGEOT - 207 Kasten/Schrägheck (WA_, WC_) 04/06→								
 Hauptbremszylinder								
1.4	54	06/07→10/08			+ ESP		24.4122-1703.3 010843	TRW Ø 22,2
					- ESP		24.4122-1704.3 010847	TRW Ø 22,2
1.4 HDi 1.6 HDi	50 66 - 68	04/07→ 04/07→03/13			→ 06/12; + ESP		24.4122-1703.3 010843	TRW Ø 22,2
					→ 06/12; - ESP		24.4122-1704.3 010847	TRW Ø 22,2
1.6 HDi 1.6 VTi	80 88	04/06→12/12 03/07→12/12			+ ESP		24.4123-1704.3 010828	TRW Ø 23,8
					- ESP		24.4123-1705.3 010832	TRW Ø 23,8
PEUGEOT - 207 Stufenheck 12/07→12/14								
 Bremskraftverstärker								
2.0 HDi	66	12/07→12/12			+ ABS		03.7853-2604.4 300322	ATE Ø 9" pneumatisch
 Hauptbremszylinder								
1.4	54 - 55	12/07→12/12			→ 06/12; + ESP		24.4122-1703.3 010843	TRW Ø 22,2
1.4 Flex 1.6 Bioflex	60 83	11/08→12/14 01/08→12/13			→ 06/12; - ESP		24.4122-1704.3 010847	TRW Ø 22,2
2.0 HDi	66	12/07→12/12			+ ABS		03.2122-1351.3 010528	Ø 22,2
PEUGEOT - 207 SW (WK_) 02/07→12/13								
 Bremskraftverstärker								
2.0 HDi	66	10/08→12/12			+ ABS		03.7853-2604.4 300322	ATE Ø 9" pneumatisch
 Hauptbremszylinder								
1.4 1.4 16V 1.4 Flex 1.4 LPG	54 72 59 54	06/07→12/12 11/09→12/12 08/08→01/13 08/07→12/12			+ ESP		24.4122-1703.3 010843	TRW Ø 22,2
					- ESP		24.4122-1704.3 010847	TRW Ø 22,2
1.4 16V	70	06/07→10/13			→ 07/13; + ESP		24.4122-1703.3 010843	TRW Ø 22,2
					→ 07/13; - ESP		24.4122-1704.3 010847	TRW Ø 22,2
1.6 1.6 Flex	81 83	08/08→12/12 08/08→12/13			→ 06/12; + ESP		24.4122-1703.3 010843	TRW Ø 22,2
					→ 06/12; - ESP		24.4122-1704.3 010847	TRW Ø 22,2
1.6 16V 1.6 HDi	88 82	06/07→10/13 08/09→10/13			→ 07/13; + ESP		24.4123-1704.3 010828	TRW Ø 23,8
					→ 07/13; - ESP		24.4123-1705.3 010832	TRW Ø 23,8
1.6 16V RC	128	02/07→12/12			11/07→; + ESP		24.4123-1704.3 010828	TRW Ø 23,8
					11/07→; - ESP		24.4123-1705.3 010832	TRW Ø 23,8
1.6 16V Turbo 1.6 HDi	110 66 - 80	02/07→12/12 06/07→12/13			+ ESP		24.4123-1704.3 010828	TRW Ø 23,8
					- ESP		24.4123-1705.3 010832	TRW Ø 23,8
2.0 HDi	66	10/08→12/12			+ ABS		03.2122-1351.3 010528	Ø 22,2
PEUGEOT - 207 SW Kasten/Kombi (WK_) 08/07→12/12								
 Hauptbremszylinder								
1.6 HDi	66	08/07→12/12			+ ESP		24.4122-1703.3 010843	TRW Ø 22,2
					- ESP		24.4122-1704.3 010847	TRW Ø 22,2
1.6 HDi	80	08/07→12/12			+ ESP		24.4123-1704.3 010828	TRW Ø 23,8
					- ESP		24.4123-1705.3 010832	TRW Ø 23,8







	kw			 	! #		
PEUGEOT - 208 I (CA_, CC_) 03/12→03/20							
 Hauptbremszylinder							
1.0 VTi	50	03/12→12/19		Orga 13342→; Trommelbremse; + DSC	24.4122-1703.3	010843	TRW Ø 22,2
1.2 GPL	60	06/15→12/19		Orga 13342→; Trommelbremse; - DSC	24.4122-1704.3	010847	TRW Ø 22,2
1.2 THP 110	81	01/13→12/19		→Orga 13341; Trommelbremse; + DSC	24.4122-1726.3	011096	Ø 22,2 ohne Bremsflüssigkeitsbehälter
1.2 VTi 82	60	03/12→12/19		Scheibenbremse; + DSC	24.4123-1704.3	010828	TRW Ø 23,8
				Scheibenbremse; - DSC	24.4123-1705.3	010832	TRW Ø 23,8
1.2 PureTech 82	61	03/18→12/19		→Orga 13341; Trommelbremse; + DSC	24.4122-1726.3	011096	Ø 22,2 ohne Bremsflüssigkeitsbehälter
1.2 VTi 68 / PureTech 68	50	08/16→12/19		Scheibenbremse; + DSC	24.4123-1704.3	010828	TRW Ø 23,8
1.5 BlueHDI 100	75	05/18→12/19		Scheibenbremse; - DSC	24.4123-1705.3	010832	TRW Ø 23,8
1.4 GPL	70	10/13→12/19		Trommelbremse; + DSC	24.4122-1703.3	010843	TRW Ø 22,2
1.4 HDi	50	03/12→12/19		Trommelbremse; - DSC	24.4122-1704.3	010847	TRW Ø 22,2
1.4 VTi	70	03/12→12/19		Scheibenbremse; + DSC	24.4123-1704.3	010828	TRW Ø 23,8
1.6	85	01/13→12/19		Scheibenbremse; - DSC	24.4123-1705.3	010832	TRW Ø 23,8
1.6 BlueHDI 120	88	01/15→12/19					
1.6 e-HDi	82	07/15→12/19					
1.6 HDi	68 - 85	03/12→12/19					
1.6 HDi / BlueHDI 75	55	01/13→12/19					
1.6 THP	115	03/12→12/19					
1.6 VTi	88	03/12→12/19					
1.6 BlueHDI 100	73	01/15→12/19		Scheibenbremse; + DSC	24.4123-1704.3	010828	TRW Ø 23,8
1.6 THP 165	121	03/15→12/19		Scheibenbremse; - DSC	24.4123-1705.3	010832	TRW Ø 23,8
1.6 GTi	147	08/12→12/19		03/13→; + DSC	24.4123-1704.3	010828	TRW Ø 23,8
				03/13→; - DSC	24.4123-1705.3	010832	TRW Ø 23,8
1.6 GTi	153	10/14→12/19		+ DSC	24.4123-1704.3	010828	TRW Ø 23,8
				- DSC	24.4123-1705.3	010832	TRW Ø 23,8
PEUGEOT - 208 Kasten/Schrägheck (CR_) 02/13→12/19							
 Hauptbremszylinder							
1.2 VTi 68 / PureTech 68	50	06/15→12/19		Trommelbremse; →Orga 13341; + DSC	24.4122-1726.3	011096	Ø 22,2 ohne Bremsflüssigkeitsbehälter
1.5 BlueHdi 100	75	05/18→12/19		Scheibenbremse; + DSC	24.4123-1704.3	010828	TRW Ø 23,8
				Scheibenbremse; - DSC	24.4123-1705.3	010832	TRW Ø 23,8
1.2 VTi 82 / PureTech 82	60	06/15→12/19		Orga 13342 →; Trommelbremse; + DSC	24.4122-1703.3	010843	TRW Ø 22,2
				Orga 13342 →; Trommelbremse; - DSC	24.4122-1704.3	010847	TRW Ø 22,2
				Trommelbremse; →Orga 13341; + DSC	24.4122-1726.3	011096	Ø 22,2 ohne Bremsflüssigkeitsbehälter
				Scheibenbremse; + DSC	24.4123-1704.3	010828	TRW Ø 23,8
				Scheibenbremse; - DSC	24.4123-1705.3	010832	TRW Ø 23,8
1.4 HDi 68	50	02/13→12/19		Trommelbremse; + DSC	24.4122-1703.3	010843	TRW Ø 22,2
1.6 BlueHDI 75	55	04/15→12/19		Trommelbremse; - DSC	24.4122-1704.3	010847	TRW Ø 22,2
1.6 HDi 92	68	03/14→12/19		Scheibenbremse; + DSC	24.4123-1704.3	010828	TRW Ø 23,8
				Scheibenbremse; - DSC	24.4123-1705.3	010832	TRW Ø 23,8
1.6 Blue HDi 100	73	06/15→12/19		Scheibenbremse; + DSC	24.4123-1704.3	010828	TRW Ø 23,8
				Scheibenbremse; - DSC	24.4123-1705.3	010832	TRW Ø 23,8
PEUGEOT - 301 11/12→							
 Hauptbremszylinder							
1.2 PureTech 82	61	02/18→		+ DSC	24.4122-1703.3	010843	TRW Ø 22,2
				- DSC	24.4122-1704.3	010847	TRW Ø 22,2
				+ DSC; Orga 15344→	24.4122-1726.3	011096	Ø 22,2 ohne Bremsflüssigkeitsbehälter
1.2 VTi 72	53	11/12→		+ ESP	24.4122-1726.3	011096	Ø 22,2 ohne Bremsflüssigkeitsbehälter
1.2 VTi 82	60	12/14→					
1.6 LPG	85	07/14→					
1.6 VTi 115	85	11/12→10/17					
1.5 BlueHDI 100	75	05/18→		+ ESP	24.4122-1703.3	010843	TRW Ø 22,2
1.6 BlueHDI 100	73	04/14→					
1.6 HDi 90	68	11/12→					
PEUGEOT - 306 (7B, N3, N5) 04/93→10/03							
 Bremskraftverstärker							
1.1	44	06/94→05/01		→ 04/97; + ABS; für Linkslenker	03.7750-9402.4	300117	ATE Ø 9" pneumatisch
1.4 SL	55	06/94→05/01		05/97→; - ABS	03.7750-9302.4	300116	ATE Ø 9" pneumatisch
				10/94→; →Orga 08575; + ABS; für Linkslenker	03.7750-9402.4	300117	ATE Ø 9" pneumatisch
→							









	kw			 	! #		
PEUGEOT - 306 (7B, N3, N5) 04/93→10/03							
Bremskraftverstärker							
1.6	72	10/00→05/01		- ABS	03.7750-9302.4	300116	ATE Ø 9" pneumatisch
1.6 SR	65	06/94→10/00		10/94→ 04/97; für Rechtslenker; + ABS	03.7750-6334.4	300321	ATE Ø 9" pneumatisch
				05/97→; - ABS; Türenanzahl: 4	03.7750-9302.4	300116	ATE Ø 9" pneumatisch
				10/94→; →Orga 08575; + ABS; für Linkslenker	03.7750-9402.4	300117	ATE Ø 9" pneumatisch
1.8 2.0 S16	74	06/94→05/01		05/97→; - ABS; für Linkslenker	03.7750-9302.4	300116	ATE Ø 9" pneumatisch
	110	06/94→05/01		→Orga 08575; + ABS; für Linkslenker	03.7750-9402.4	300117	ATE Ø 9" pneumatisch
1.8 16V 1.8 ST 2.0 ST	81	03/97→05/01		05/97→; - ABS; für Linkslenker; Türenanzahl: 4	03.7750-9302.4	300116	ATE Ø 9" pneumatisch
	74	06/94→05/01					
	89	07/94→05/01		→Orga 08575; + ABS; für Linkslenker	03.7750-9402.4	300117	ATE Ø 9" pneumatisch
1.8 16V	82	03/97→07/01		05/97→ 05/01; - ABS; für Linkslenker; Türenanzahl: 4	03.7750-9302.4	300116	ATE Ø 9" pneumatisch
				→Orga 08575; + ABS; für Linkslenker	03.7750-9402.4	300117	ATE Ø 9" pneumatisch
1.9 D 2.0 HDI 90	51	09/98→05/01		- ABS; für Linkslenker	03.7750-9302.4	300116	ATE Ø 9" pneumatisch
	66	06/99→12/01		→Orga 08575; + ABS; für Linkslenker	03.7750-9402.4	300117	ATE Ø 9" pneumatisch
1.9 D	55	03/98→05/01		- ABS; für Linkslenker	03.7750-9302.4	300116	ATE Ø 9" pneumatisch
				+ ABS; für Linkslenker	03.7750-9402.4	300117	ATE Ø 9" pneumatisch
1.9 SLD	47 - 50	06/94→05/01		05/97→; - ABS; für Linkslenker	03.7750-9302.4	300116	ATE Ø 9" pneumatisch
1.9 SRDT	66	06/94→05/01		10/94→; + ABS; für Linkslenker	03.7750-9402.4	300117	ATE Ø 9" pneumatisch
2.0	97	03/97→05/01		05/97→; - ABS; für Linkslenker; Türenanzahl: 4	03.7750-9302.4	300116	ATE Ø 9" pneumatisch
				05/97→; - ABS; für Linkslenker	03.7750-9302.4	300116	ATE Ø 9" pneumatisch
				→Orga 08575; + ABS; für Linkslenker	03.7750-9402.4	300117	ATE Ø 9" pneumatisch
2.0 S16	112	06/94→05/01		05/97→; - ABS; für Linkslenker	03.7750-9302.4	300116	ATE Ø 9" pneumatisch
				07/94→; →Orga 08575; + ABS; für Linkslenker	03.7750-9402.4	300117	ATE Ø 9" pneumatisch
Hauptbremszylinder							
1.1	44	06/94→05/01		→ 04/97; - ABS; Türenanzahl: 5	03.2119-3391.3	010058	ATE Ø 19
				→ 04/97; - ABS; Türenanzahl: 3	24.2120-1704.3	010429	BDX Ø 20,6
1.4 SL	55	06/94→05/01		10/94→ 04/97; - ABS; nicht für Fahrschulwagen	03.2119-3391.3	010058	ATE Ø 19
				05/97→; - ABS	03.2120-4321.3	010525	ATE Ø 20,6
					24.2120-1726.3	010564	BDX Ø 20,6
				05/97→; →Orga 08575; + ABS; für Linkslenker	03.2122-1351.3	010528	Ø 22,2
				10/94→ 04/97; - ABS; für Fahrschulwagen	24.2120-1704.3	010429	BDX Ø 20,6
1.6	72	10/00→05/01		- ABS	03.2120-4321.3	010525	ATE Ø 20,6
				+ ABS; für Linkslenker	24.2120-1726.3	010564	BDX Ø 20,6
1.6 SR	65	06/94→10/00		10/94→ 04/97; - ABS; für Linkslenker	03.2120-1897.3	010103	ATE Ø 20,6
					24.2120-1704.3	010429	BDX Ø 20,6
				05/97→; - ABS; Türenanzahl: 4	03.2120-4321.3	010525	ATE Ø 20,6
					24.2120-1726.3	010564	BDX Ø 20,6
				05/97→; →Orga 08575; + ABS; für Linkslenker	03.2122-1351.3	010528	Ø 22,2
1.8	74	06/94→05/01		Orga 08576→; + ABS; für Linkslenker	24.2123-1715.3	010520	BDX Ø 23,8
				- ABS; für Linkslenker	03.2120-1897.3	010103	ATE Ø 20,6
					24.2120-1704.3	010429	BDX Ø 20,6
				05/97→; - ABS; für Linkslenker	03.2120-4321.3	010525	ATE Ø 20,6
					24.2120-1726.3	010564	BDX Ø 20,6
1.8 16V	81	03/97→05/01		05/97→; →Orga 08575; + ABS; für Linkslenker	03.2122-1351.3	010528	Ø 22,2
					24.2122-1733.3	010668	Ø 22,2
				- ABS; für Rechtslenker	24.2120-1722.3	010544	Ø 20,6
				Orga 08576→; + ABS; für Linkslenker	24.2123-1715.3	010520	BDX Ø 23,8
				→ 04/97; - ABS; für Linkslenker; Türenanzahl: 4	03.2120-1897.3	010103	ATE Ø 20,6
		24.2120-1704.3	010429	BDX Ø 20,6			
		05/97→; →Orga 08575; + ABS; für Linkslenker	03.2122-1351.3	010528	Ø 22,2		
		05/97→; - ABS; für Linkslenker; Türenanzahl: 4	03.2122-1356.3	010529	Ø 22,2		















	kw			 	! #		
PEUGEOT - 306 (7B, N3, N5) 04/93→10/03							
Hauptbremszylinder							
1.8 16V	81	03/97→05/01		Orga 08576→; + ABS; für Linkslenker	24.2123-1715.3	010520	BDX Ø 23,8
1.8 16V	82	03/97→07/01		→ 04/97; - ABS; für Linkslenker; Türenanzahl: 4	03.2120-1897.3	010103	ATE Ø 20,6
					24.2120-1704.3	010429	BDX Ø 20,6
				05/97→; →Orga 08575; + ABS; für Linkslenker	03.2122-1351.3	010528	Ø 22,2
				05/97→ 05/01; - ABS; für Linkslenker; Türenanzahl: 4	03.2122-1356.3	010529	Ø 22,2
1.8 ST	74	06/94→05/01		Orga 08576→; → 05/01; + ABS; für Linkslenker	24.2123-1715.3	010520	BDX Ø 23,8
				10/94→ 04/97; - ABS; für Linkslenker	03.2120-1897.3	010103	ATE Ø 20,6
					24.2120-1704.3	010429	BDX Ø 20,6
				05/97→; - ABS; für Linkslenker; Türenanzahl: 4	03.2120-4321.3	010525	ATE Ø 20,6
					24.2120-1726.3	010564	BDX Ø 20,6
1.9 D	51	09/98→05/01		05/97→; →Orga 08575; + ABS; für Linkslenker	03.2122-1351.3	010528	Ø 22,2
					03.2122-1356.3	010529	Ø 22,2
				10/94→; - ABS; für Rechtslenker; Türenanzahl: 4	24.2120-1722.3	010544	Ø 20,6
				Orga 08576→; + ABS; für Linkslenker	24.2123-1715.3	010520	BDX Ø 23,8
1.9 D	55	03/98→05/01		- ABS; für Linkslenker	03.2120-4321.3	010525	ATE Ø 20,6
					24.2120-1726.3	010564	BDX Ø 20,6
				→Orga 08575; + ABS; für Linkslenker	03.2122-1351.3	010528	Ø 22,2
				- ABS; für Rechtslenker	03.2122-1461.3	010610	ATE Ø 22,2
				→Orga 08575; + ABS; für Rechtslenker	03.2122-1461.3	010610	ATE Ø 22,2
1.9 SLD	47 - 50	06/94→05/01		Orga 08576→; + ABS; für Linkslenker	24.2123-1715.3	010520	BDX Ø 23,8
				10/94→ 04/97; - ABS; für Linkslenker	03.2120-1897.3	010103	ATE Ø 20,6
					24.2120-1704.3	010429	BDX Ø 20,6
				05/97→; - ABS; für Linkslenker	03.2120-4321.3	010525	ATE Ø 20,6
1.9 SRDT	66	06/94→05/01			24.2120-1726.3	010564	BDX Ø 20,6
				05/97→; →Orga 08575; + ABS; für Linkslenker	03.2122-1351.3	010528	Ø 22,2
					03.2122-1356.3	010529	Ø 22,2
				Orga 08576→; + ABS; für Linkslenker	24.2123-1715.3	010520	BDX Ø 23,8
				10/94→ 04/97; - ABS; für Linkslenker	03.2120-1897.3	010103	ATE Ø 20,6
2.0	97	03/97→05/01			24.2120-1704.3	010429	BDX Ø 20,6
				→ 04/97; - ABS; für Linkslenker	03.2120-1897.3	010103	ATE Ø 20,6
					24.2120-1704.3	010429	BDX Ø 20,6
				→ 04/97; - ABS; für Linkslenker; Türenanzahl: 4	03.2120-1897.3	010103	ATE Ø 20,6
					24.2120-1704.3	010429	BDX Ø 20,6
				05/97→; →Orga 08575; + ABS; für Linkslenker	03.2122-1351.3	010528	Ø 22,2
					24.2122-1733.3	010668	Ø 22,2
2.0 HDI 90	66	06/99→12/01		05/97→; - ABS; für Linkslenker; Türenanzahl: 4	03.2122-1356.3	010529	Ø 22,2
					03.2122-1356.3	010529	Ø 22,2
2.0 S16	110	06/94→05/01		Orga 08576→; + ABS; für Linkslenker	24.2123-1715.3	010520	BDX Ø 23,8
				- ABS; für Linkslenker	03.2122-1356.3	010529	Ø 22,2
				+ ABS; für Linkslenker	24.2123-1715.3	010520	BDX Ø 23,8
				→ 04/97; - ABS; für Linkslenker	03.2120-1897.3	010103	ATE Ø 20,6
2.0 S16	112	06/94→05/01			24.2120-1704.3	010429	BDX Ø 20,6
				05/97→; →Orga 08575; + ABS; für Linkslenker	03.2122-1351.3	010528	Ø 22,2
					03.2122-1356.3	010529	Ø 22,2
→				Orga 08576→; + ABS; für Linkslenker	24.2123-1715.3	010520	BDX Ø 23,8
				07/94→ 04/97; - ABS; für Linkslenker	03.2120-1897.3	010103	ATE Ø 20,6
					24.2120-1704.3	010429	BDX Ø 20,6













	kw					! #		
PEUGEOT - 306 (7B, N3, N5) 04/93→10/03								
 Hauptbremszylinder								
2.0 S16	112	06/94→05/01		05/97→; →Orga 08575; + ABS; für Linkslenker		03.2122-1351.3	010528	Ø 22,2
				05/97→; - ABS; für Linkslenker		03.2122-1356.3	010529	Ø 22,2
				Orga 08576→; + ABS; für Linkslenker		24.2123-1715.3	010520	BDX Ø 23,8
2.0 ST	89	07/94→05/01		10/94→ 04/97; - ABS; für Linkslenker; Türenanzahl: 4		03.2120-1897.3	010103	ATE Ø 20,6
				05/97→; →Orga 08575; + ABS; für Linkslenker		03.2122-1351.3	010528	Ø 22,2
				05/97→; - ABS; für Linkslenker; Türenanzahl: 4		03.2122-1356.3	010529	Ø 22,2
				Orga 08576→; + ABS; für Linkslenker		24.2123-1715.3	010520	BDX Ø 23,8
PEUGEOT - 306 Break (7E, N3, N5) 06/94→12/02								
 Bremskraftverstärker								
1.4	55	03/97→04/02		→ 03/02; - ABS		03.7750-9302.4	300116	ATE Ø 9" pneumatisch
1.6	72	10/00→04/02						
1.6	65	03/97→10/00		- ABS		03.7750-9302.4	300116	ATE Ø 9" pneumatisch
1.8 D	44	05/97→06/00		- ABS; für Linkslenker		03.7750-9302.4	300116	ATE Ø 9" pneumatisch
1.9 D	50 - 55	03/97→04/02		→ 03/02; - ABS; für Linkslenker		03.7750-9302.4	300116	ATE Ø 9" pneumatisch
 Hauptbremszylinder								
1.4	55	03/97→04/02		→ 03/02; - ABS		03.2122-1356.3	010529	Ø 22,2
1.6	72	10/00→04/02		→ 03/02; + ABS; für Linkslenker		24.2123-1715.3	010520	BDX Ø 23,8
1.6	65	03/97→10/00		- ABS		03.2122-1356.3	010529	Ø 22,2
				+ ABS; für Linkslenker		24.2123-1715.3	010520	BDX Ø 23,8
1.8	74	03/97→04/02		→ 03/02; für Linkslenker; - ABS		24.2123-1714.3	010587	BDX Ø 23,8
1.8 16V	81	03/97→04/02						
2.0	97	03/97→04/02		→ 03/02; + ABS; für Linkslenker		24.2123-1715.3	010520	BDX Ø 23,8
2.0 16V	99	03/97→04/02						
2.0 HDI 90	66	06/99→04/02						
1.8 16V	82	03/97→07/01		für Linkslenker; - ABS		24.2123-1714.3	010587	BDX Ø 23,8
				+ ABS; für Linkslenker		24.2123-1715.3	010520	BDX Ø 23,8
1.8 D	44	05/97→06/00		- ABS; für Linkslenker		03.2122-1356.3	010529	Ø 22,2
				+ ABS; für Linkslenker		24.2123-1715.3	010520	BDX Ø 23,8
1.9 D	50 - 55	03/97→04/02		→ 03/02; - ABS; für Linkslenker		03.2122-1356.3	010529	Ø 22,2
				→ 03/02; + ABS; für Linkslenker		24.2123-1715.3	010520	BDX Ø 23,8
1.9 Td	52	07/95→08/00		03/97→; - ABS; für Linkslenker		03.2122-1356.3	010529	Ø 22,2
						24.2123-1714.3	010587	BDX Ø 23,8
				03/97→; + ABS; für Linkslenker		24.2123-1715.3	010520	BDX Ø 23,8
1.9 TD	66	02/97→04/02		03/97→ 03/02; - ABS; für Linkslenker		03.2122-1356.3	010529	Ø 22,2
						24.2123-1714.3	010587	BDX Ø 23,8
				03/97→ 03/02; + ABS; für Linkslenker		24.2123-1715.3	010520	BDX Ø 23,8
PEUGEOT - 306 Cabriolet (7D, N3, N5) 01/94→04/02								
 Bremskraftverstärker								
1.6	65	04/96→10/00		für Rechtslenker		03.7750-6334.4	300321	ATE Ø 9" pneumatisch
				→Orga 08575; für Linkslenker		03.7750-9402.4	300117	ATE Ø 9" pneumatisch
1.8	74	03/94→04/02		→Orga 08575; für Linkslenker		03.7750-9402.4	300117	ATE Ø 9" pneumatisch
2.0	89	03/94→04/02						
2.0 16V	97 - 99	03/97→04/02						
 Hauptbremszylinder								
1.6	65	04/96→10/00		→Orga 07737; - ABS		03.2120-4241.3	010524	ATE Ø 20,6
						24.2120-1722.3	010544	Ø 20,6
				→Orga 08575; + ABS; für Linkslenker		03.2122-1351.3	010528	Ø 22,2
				Orga 08576→; für Linkslenker; + ABS		24.2123-1715.3	010520	BDX Ø 23,8
1.6	72	10/00→04/02		+ ABS; für Linkslenker		24.2123-1715.3	010520	BDX Ø 23,8
1.8 16V	81	05/97→04/02						
1.8	74	03/94→04/02		→Orga 08575; + ABS; für Linkslenker		03.2122-1351.3	010528	Ø 22,2
				→ 10/00; - ABS		24.2120-1722.3	010544	Ø 20,6
				Orga 08576→; → 10/00; + ABS; für Linkslenker		24.2123-1715.3	010520	BDX Ø 23,8
2.0	89	03/94→04/02		→ 04/97; + ABS; für Linkslenker		03.2122-1351.3	010528	Ø 22,2
2.0 16V	97	03/97→04/02		→Orga 08575; + ABS; für Linkslenker		03.2122-1351.3	010528	Ø 22,2
→								











	kw					! #		
PEUGEOT - 306 Cabriolet (7D, N3, N5) 01/94→04/02								
 Hauptbremszylinder								
2.0 16V	97	03/97→04/02		Orga 08576→; → 10/00; + ABS; für Linkslenker		24.2123-1715.3	010520	BDX Ø 23,8
2.0 16V	99	03/97→04/02		→Orga 08575; + ABS; für Linkslenker		03.2122-1351.3	010528	Ø 22,2
				Orga 08576→; für Linkslenker; + ABS		24.2123-1715.3	010520	BDX Ø 23,8
PEUGEOT - 306 Kasten/Kombi (N_, 7_) 07/93→08/02								
 Bremskraftverstärker								
1.4	55	03/96→07/01		05/97→ 05/01; - ABS		03.7750-9302.4	300116	ATE Ø 9" pneumatisch
				→Orga 08575; + ABS; für Linkslenker		03.7750-9402.4	300117	ATE Ø 9" pneumatisch
1.8 D	44	05/97→06/00		- ABS; für Linkslenker		03.7750-9302.4	300116	ATE Ø 9" pneumatisch
1.9 D	51	02/99→08/02		→ 03/02; - ABS; für Linkslenker		03.7750-9302.4	300116	ATE Ø 9" pneumatisch
 Hauptbremszylinder								
1.4	55	03/96→07/01		→ 04/97; - ABS; nicht für Fahrschulwagen; Türenanzahl: 5		03.2119-3391.3	010058	ATE Ø 19
				05/97→ 05/01; - ABS		24.2119-1702.3	010435	BDX Ø 19
				05/97→; →Orga 08575; + ABS; für Linkslenker		03.2120-4321.3	010525	ATE Ø 20,6
						24.2120-1726.3	010564	BDX Ø 20,6
				→ 04/97; - ABS; für Fahrschulwagen; Türenanzahl: 3		03.2122-1351.3	010528	Ø 22,2
				Orga 08576→; → 05/01; + ABS; für Linkslenker		24.2122-1733.3	010668	Ø 22,2
1.8 D	44	05/97→06/00		- ABS; für Linkslenker		24.2120-1704.3	010429	BDX Ø 20,6
				+ ABS; für Linkslenker		24.2123-1715.3	010520	BDX Ø 23,8
1.9 D	51	02/99→08/02		→ 03/02; - ABS; für Linkslenker		03.2122-1356.3	010529	Ø 22,2
				→ 03/02; + ABS; für Linkslenker		24.2123-1715.3	010520	BDX Ø 23,8
2.0 HDi	66	08/98→06/00		- ABS; für Linkslenker		24.2123-1714.3	010587	BDX Ø 23,8
				+ ABS; für Linkslenker		24.2123-1715.3	010520	BDX Ø 23,8
PEUGEOT - 306 Kasten/Schrägheck 04/93→08/01								
 Bremskraftverstärker								
1.4	55	03/96→07/01		05/97→ 05/01; - ABS		03.7750-9302.4	300116	ATE Ø 9" pneumatisch
				→Orga 08575; + ABS; für Linkslenker		03.7750-9402.4	300117	ATE Ø 9" pneumatisch
1.9 D	51	02/99→08/01		→Orga 08575; + ABS; für Linkslenker		03.7750-9402.4	300117	ATE Ø 9" pneumatisch
 Hauptbremszylinder								
1.4	55	03/96→07/01		→ 04/97; - ABS; nicht für Fahrschulwagen; Türenanzahl: 5		03.2119-3391.3	010058	ATE Ø 19
				05/97→ 05/01; - ABS		24.2119-1702.3	010435	BDX Ø 19
				05/97→; →Orga 08575; + ABS; für Linkslenker		03.2120-4321.3	010525	ATE Ø 20,6
						24.2120-1726.3	010564	BDX Ø 20,6
				→ 04/97; - ABS; für Fahrschulwagen; Türenanzahl: 3		03.2122-1351.3	010528	Ø 22,2
				Orga 08576→; → 05/01; + ABS; für Linkslenker		24.2122-1733.3	010668	Ø 22,2
1.9 D	51	02/99→08/01		→ 05/01; - ABS; für Rechtslenker		24.2120-1704.3	010429	BDX Ø 20,6
				→Orga 08575; + ABS; für Rechtslenker		24.2123-1715.3	010520	BDX Ø 23,8
						03.2122-1461.3	010610	ATE Ø 22,2
						03.2122-1461.3	010610	ATE Ø 22,2
PEUGEOT - 306 Schrägheck (7A, 7C, N3, N5) 01/93→10/03								
 Bremskraftverstärker								
1.1	44	05/93→05/01		03/94→ 04/97; + ABS; für Linkslenker		03.7750-9402.4	300117	ATE Ø 9" pneumatisch
1.4	55	04/93→07/01		05/97→; - ABS		03.7750-9302.4	300116	ATE Ø 9" pneumatisch
				→Orga 08575; + ABS; für Linkslenker		03.7750-9402.4	300117	ATE Ø 9" pneumatisch
1.6	65	05/93→10/00		→ 04/97; + ABS; für Rechtslenker		03.7750-6334.4	300321	ATE Ø 9" pneumatisch
				05/97→; - ABS		03.7750-9302.4	300116	ATE Ø 9" pneumatisch
				→Orga 08575; + ABS; für Linkslenker		03.7750-9402.4	300117	ATE Ø 9" pneumatisch
1.6	72	10/00→05/01		- ABS		03.7750-9302.4	300116	ATE Ø 9" pneumatisch
1.8	74	05/93→05/01		05/97→; - ABS; für Linkslenker		03.7750-9302.4	300116	ATE Ø 9" pneumatisch
1.8 16V	81	03/97→05/01		→Orga 08575; + ABS; für Linkslenker		03.7750-9402.4	300117	ATE Ø 9" pneumatisch
1.9 Td	52	07/95→08/00						
2.0 16V	99	03/97→06/00						
2.0 S16	110	06/94→05/01						
→								











	kw			 	! #		
PEUGEOT - 306 Schrägheck (7A, 7C, N3, N5) 01/93→10/03							
Bremskraftverstärker							
1.8 16V	82	03/97→10/03		05/97→ 05/01; - ABS; für Linkslenker →Orga 08575; + ABS; für Linkslenker	03.7750-9302.4 300116 03.7750-9402.4 300117	ATE Ø 9" pneumatisch ATE Ø 9" pneumatisch	
1.8 D 1.9 D	43 47 - 50	05/93→05/01 05/93→05/01		05/97→; - ABS; für Linkslenker + ABS; für Linkslenker	03.7750-9302.4 300116 03.7750-9402.4 300117	ATE Ø 9" pneumatisch ATE Ø 9" pneumatisch	
1.9 D 2.0 HDI 90	51 66	09/98→05/01 06/99→12/02		- ABS; für Linkslenker →Orga 08575; + ABS; für Linkslenker	03.7750-9302.4 300116 03.7750-9402.4 300117	ATE Ø 9" pneumatisch ATE Ø 9" pneumatisch	
1.9 D	52	01/99→08/03		→Orga 08575; + ABS; für Linkslenker	03.7750-9402.4 300117	ATE Ø 9" pneumatisch	
1.9 D	55	03/98→05/01		- ABS; für Linkslenker + ABS; für Linkslenker	03.7750-9302.4 300116 03.7750-9402.4 300117	ATE Ø 9" pneumatisch ATE Ø 9" pneumatisch	
1.9 DT	66	05/93→05/01		05/97→; - ABS; für Linkslenker 10/93→; →Orga 08575; + ABS; für Linkslenker	03.7750-9302.4 300116 03.7750-9402.4 300117	ATE Ø 9" pneumatisch ATE Ø 9" pneumatisch	
2.0 16V	97	03/97→05/01		05/97→; - ABS; für Linkslenker; Türenanzahl: 4 →Orga 08575; + ABS; für Linkslenker	03.7750-9302.4 300116 03.7750-9402.4 300117	ATE Ø 9" pneumatisch ATE Ø 9" pneumatisch	
2.0 S16	112	05/93→05/01		05/97→; - ABS; für Linkslenker 07/94→; →Orga 08575; + ABS; für Linkslenker	03.7750-9302.4 300116 03.7750-9402.4 300117	ATE Ø 9" pneumatisch ATE Ø 9" pneumatisch	
2.0 XSi	89	05/93→05/01		05/97→; - ABS; für Linkslenker 03/94→; →Orga 08575; + ABS; für Linkslenker	03.7750-9302.4 300116 03.7750-9402.4 300117	ATE Ø 9" pneumatisch ATE Ø 9" pneumatisch	
Hauptbremszylinder							
1.1	44	05/93→05/01		03/94→ 04/97; - ABS; Türenanzahl: 5 03/94→ 04/97; - ABS; Türenanzahl: 3	03.2119-3391.3 010058 24.2119-1702.3 010435 24.2120-1704.3 010429	ATE Ø 19 BDX Ø 19 BDX Ø 20,6	
1.4	55	04/93→07/01		→ 04/97; - ABS; nicht für Fahrschulwagen; Türenanzahl: 5 05/97→; - ABS 05/97→; →Orga 08575; + ABS; für Linkslenker → 04/97; - ABS; für Fahrschulwagen; Türenanzahl: 3 Orga 08576→; + ABS; für Linkslenker	03.2119-3391.3 010058 24.2119-1702.3 010435 03.2120-4321.3 010525 24.2120-1726.3 010564 03.2122-1351.3 010528 24.2122-1733.3 010668 24.2120-1704.3 010429 24.2123-1715.3 010520	ATE Ø 19 BDX Ø 19 ATE Ø 20,6 BDX Ø 20,6 Ø 22,2 Ø 22,2 BDX Ø 20,6 BDX Ø 23,8	
1.6	65	05/93→10/00		→ 04/97; - ABS 05/97→; - ABS 05/97→; →Orga 08575; + ABS; für Linkslenker Orga 08576→; + ABS; für Linkslenker	03.2120-1897.3 010103 24.2120-1704.3 010429 03.2120-4321.3 010525 24.2120-1726.3 010564 03.2122-1351.3 010528 24.2122-1733.3 010668 24.2123-1715.3 010520	ATE Ø 20,6 BDX Ø 20,6 ATE Ø 20,6 BDX Ø 20,6 Ø 22,2 Ø 22,2 BDX Ø 23,8	
1.6	72	10/00→05/01		- ABS + ABS; für Linkslenker	03.2120-4321.3 010525 24.2120-1726.3 010564 24.2123-1715.3 010520	ATE Ø 20,6 BDX Ø 20,6 BDX Ø 23,8	
1.8 1.8 D 1.9 D	74 43 47 - 50	05/93→05/01 05/93→05/01 05/93→05/01		→ 04/97; - ABS; für Linkslenker 05/97→; - ABS; für Linkslenker 05/97→; →Orga 08575; + ABS; für Linkslenker - ABS; für Rechtslenker Orga 08576→; + ABS; für Linkslenker	03.2120-1897.3 010103 24.2120-1704.3 010429 03.2120-4321.3 010525 24.2120-1726.3 010564 03.2122-1351.3 010528 24.2122-1733.3 010668 24.2120-1722.3 010544 24.2123-1715.3 010520	ATE Ø 20,6 BDX Ø 20,6 ATE Ø 20,6 BDX Ø 20,6 Ø 22,2 Ø 22,2 Ø 20,6 BDX Ø 23,8	
1.8 16V 1.9 Td 2.0 16V 2.0 S16	81 52 99 110	03/97→05/01 07/95→08/00 03/97→06/00 06/94→05/01		→ 04/97; - ABS; für Linkslenker 05/97→; →Orga 08575; + ABS; für Linkslenker 05/97→; - ABS; für Linkslenker Orga 08576→; + ABS; für Linkslenker	03.2120-1897.3 010103 24.2120-1704.3 010429 03.2122-1351.3 010528 24.2122-1733.3 010668 03.2122-1356.3 010529 24.2123-1715.3 010520	ATE Ø 20,6 BDX Ø 20,6 Ø 22,2 Ø 22,2 Ø 22,2 BDX Ø 23,8	
1.8 16V	82	03/97→10/03		→ 04/97; - ABS; für Linkslenker 05/97→; →Orga 08575; + ABS; für Linkslenker	03.2120-1897.3 010103 24.2120-1704.3 010429 03.2122-1351.3 010528	ATE Ø 20,6 BDX Ø 20,6 Ø 22,2	

	kw					! #		
PEUGEOT - 306 Schrägheck (7A, 7C, N3, N5) 01/93→10/03								
 Hauptbremszylinder								
1.8 16V	82	03/97→10/03		05/97→; →Orga 08575; + ABS; für Linkslenker			24.2122-1733.3 010668	Ø 22,2
				05/97→ 05/01; - ABS; für Linkslenker			03.2122-1356.3 010529	Ø 22,2
				Orga 08576→; → 05/01; + ABS; für Linkslenker			24.2123-1715.3 010520	BDX Ø 23,8
1.9 D	51	09/98→05/01		- ABS; für Linkslenker			03.2120-4321.3 010525	ATE Ø 20,6
				→Orga 08575; + ABS; für Linkslenker			24.2120-1726.3 010564	BDX Ø 20,6
				→Orga 08575; + ABS; für Linkslenker			03.2122-1351.3 010528	Ø 22,2
				→Orga 08575; + ABS; für Linkslenker			24.2122-1733.3 010668	Ø 22,2
				- ABS; für Rechtslenker			03.2122-1461.3 010610	ATE Ø 22,2
				→Orga 08575; + ABS; für Rechtslenker			03.2122-1461.3 010610	ATE Ø 22,2
1.9 D	52	01/99→08/03		→ 05/01; - ABS; für Rechtslenker			03.2122-1461.3 010610	ATE Ø 22,2
				→Orga 08575; + ABS; für Rechtslenker			03.2122-1461.3 010610	ATE Ø 22,2
1.9 D	55	03/98→05/01		- ABS; für Linkslenker			03.2120-4321.3 010525	ATE Ø 20,6
				→Orga 08575; + ABS; für Linkslenker			24.2120-1726.3 010564	BDX Ø 20,6
				→Orga 08575; + ABS; für Linkslenker			03.2122-1351.3 010528	Ø 22,2
1.9 DT	66	05/93→05/01		10/93→ 04/97; - ABS; für Linkslenker			24.2122-1733.3 010668	Ø 22,2
				10/93→ 04/97; - ABS; für Linkslenker			03.2120-1897.3 010103	ATE Ø 20,6
				10/93→ 04/97; - ABS; für Linkslenker			24.2120-1704.3 010429	BDX Ø 20,6
				Orga 08576→; + ABS; für Linkslenker			03.2122-1351.3 010528	Ø 22,2
2.0 16V	97	03/97→05/01		05/97→; →Orga 08575; + ABS; für Linkslenker			24.2122-1356.3 010668	Ø 22,2
				05/97→; →Orga 08575; + ABS; für Linkslenker			03.2122-1351.3 010528	Ø 22,2
				05/97→; →Orga 08575; + ABS; für Linkslenker			24.2122-1733.3 010668	Ø 22,2
				05/97→; →Orga 08575; + ABS; für Linkslenker			03.2122-1356.3 010529	Ø 22,2
2.0 HDI 90	66	06/99→12/02		→Orga 08575; + ABS; für Linkslenker			03.2122-1351.3 010528	Ø 22,2
				→Orga 08575; + ABS; für Linkslenker			24.2122-1733.3 010668	Ø 22,2
				- ABS; für Linkslenker			03.2122-1356.3 010529	Ø 22,2
2.0 S16	112	05/93→05/01		Orga 08576→; + ABS; für Linkslenker			24.2123-1715.3 010520	BDX Ø 23,8
				07/94→ 04/97; - ABS; für Linkslenker			03.2120-1897.3 010103	ATE Ø 20,6
				07/94→ 04/97; - ABS; für Linkslenker			24.2120-1704.3 010429	BDX Ø 20,6
				05/97→; →Orga 08575; + ABS; für Linkslenker			03.2122-1351.3 010528	Ø 22,2
2.0 S16	120	06/96→05/01		05/97→; →Orga 08575; + ABS; für Linkslenker			24.2122-1733.3 010668	Ø 22,2
				05/97→; →Orga 08575; + ABS; für Linkslenker			03.2122-1356.3 010529	Ø 22,2
				05/97→; →Orga 08575; + ABS; für Linkslenker			03.2122-1356.3 010529	Ø 22,2
				05/97→; →Orga 08575; + ABS; für Linkslenker			24.2123-1715.3 010520	BDX Ø 23,8
2.0 XSi	89	05/93→05/01		- ABS			24.2123-1714.3 010587	BDX Ø 23,8
				+ ABS; für Linkslenker			24.2123-1715.3 010520	BDX Ø 23,8
				03/94→ 04/97; - ABS; für Linkslenker			03.2120-1897.3 010103	ATE Ø 20,6
2.0 XSi	89	05/93→05/01		03/94→ 04/97; - ABS; für Linkslenker			24.2120-1704.3 010429	BDX Ø 20,6
				05/97→; →Orga 08575; + ABS; für Linkslenker			03.2122-1351.3 010528	Ø 22,2
				05/97→; →Orga 08575; + ABS; für Linkslenker			24.2122-1733.3 010668	Ø 22,2
				05/97→; →Orga 08575; + ABS; für Linkslenker			03.2122-1356.3 010529	Ø 22,2
2.0 XSi	89	05/93→05/01		Orga 08576→; + ABS; für Linkslenker			24.2123-1715.3 010520	BDX Ø 23,8
				Orga 08576→; + ABS; für Linkslenker			24.2123-1715.3 010520	BDX Ø 23,8
				Orga 08576→; + ABS; für Linkslenker			24.2123-1715.3 010520	BDX Ø 23,8
PEUGEOT - 307 (3A/C) 08/00→12/12								
 Hauptbremszylinder								
1.4 16V 1.6 Flex 2.0	65 83 105	11/03→07/07 07/06→12/12 08/08→12/11		Orga 11193→; - ESP			24.4123-1730.3 011097	Ø 23,8 ohne Bremsflüssigkeitsbehälter
				Orga 11193→; + ESP			24.4123-1741.3 011151	BOS Ø 23,8 ohne Bremsflüssigkeitsbehälter
				Orga 11193→; - ESP			24.4123-1730.3 011097	Ø 23,8 ohne Bremsflüssigkeitsbehälter
1.6 1.6 16V 1.6 HDi 1.6 HDi 110 2.0 16V 2.0 HDi 135	81 80 66 80 103 - 130 100	07/06→04/12 08/00→11/07 04/05→03/09 02/04→03/09 03/05→11/07 10/03→11/07		Orga 11193→; → 07/07; + ESP			24.4123-1741.3 011151	BOS Ø 23,8 ohne Bremsflüssigkeitsbehälter
				Orga 11193→; → 07/07; + ESP			24.4123-1741.3 011151	BOS Ø 23,8 ohne Bremsflüssigkeitsbehälter
				Orga 11193→; → 07/07; + ESP			24.4123-1741.3 011151	BOS Ø 23,8 ohne Bremsflüssigkeitsbehälter
				Orga 11193→; → 07/07; + ESP			24.4123-1741.3 011151	BOS Ø 23,8 ohne Bremsflüssigkeitsbehälter











	kW					! #		
PEUGEOT - 307 Break (3E) 03/02→12/09								
 Hauptbremszylinder								
1.4 16V 1.6 16V 1.6 BioFlex 1.6 HDi 1.6 HDi 110 2.0 16V 2.0 HDi 135	65 80 80 66 80 103 - 130 100	11/03→07/07 03/02→04/08 09/07→04/08 04/05→04/08 02/04→04/08 03/05→04/08 02/04→04/08		Orga 11193→; - ESP Orga 11193→; + ESP		24.4123-1730.3 24.4123-1741.3	011097 011151	Ø 23,8 ohne Bremsflüssigkeitsbehälter BOS Ø 23,8 ohne Bremsflüssigkeitsbehälter
PEUGEOT - 307 CC (3B) 03/03→06/09								
 Hauptbremszylinder								
1.6 16V 2.0 16V 2.0 HDi 135	80 103 - 132 100	03/03→04/09 10/03→06/09 06/05→04/09		Orga 11193→; - ESP Orga 11193→; → 02/09; + ESP		24.4123-1730.3 24.4123-1741.3	011097 011151	Ø 23,8 ohne Bremsflüssigkeitsbehälter BOS Ø 23,8 ohne Bremsflüssigkeitsbehälter
PEUGEOT - 307 Stufenheck 01/01→12/12								
 Hauptbremszylinder								
1.6 2.0	81 103	08/06→12/12 09/06→12/08		Orga 11193→; - ESP Orga 11193→; + ESP		24.4123-1730.3 24.4123-1741.3	011097 011151	Ø 23,8 ohne Bremsflüssigkeitsbehälter BOS Ø 23,8 ohne Bremsflüssigkeitsbehälter
PEUGEOT - 307 SW (3H) 03/02→12/09								
 Hauptbremszylinder								
1.4 16V 1.6 16V 1.6 BioFlex 1.6 HDi 110 1.6 HDi 90 2.0 16V 2.0 HDi 135	65 80 80 80 66 103 100	11/03→07/07 03/02→04/08 09/07→04/08 11/03→12/07 04/05→04/08 03/05→04/08 02/04→04/08		Orga 11193→; - ESP Orga 11193→; + ESP		24.4123-1730.3 24.4123-1741.3	011097 011151	Ø 23,8 ohne Bremsflüssigkeitsbehälter BOS Ø 23,8 ohne Bremsflüssigkeitsbehälter
PEUGEOT - 307 SW Kasten/Kombi (3E_, 3H_) 04/02→12/09								
 Hauptbremszylinder								
1.6 HDi 2.0 HDi	66 100	04/06→10/08 04/04→11/07		Orga 11193→; - ESP Orga 11193→; + ESP		24.4123-1730.3 24.4123-1741.3	011097 011151	Ø 23,8 ohne Bremsflüssigkeitsbehälter BOS Ø 23,8 ohne Bremsflüssigkeitsbehälter
PEUGEOT - 308 I (4A_, 4C_) 09/07→12/16								
 Hauptbremszylinder								
1.4 16V 1.6 1.6 16V 1.6 BioFlex 1.6 HDi 1.6 THP 16V 2.0 HDi 1.6 2.0 Bioflex 2.0 HDi	70 - 72 120 88 - 128 80 66 - 84 115 100 - 120 85 103 103	09/07→10/14 01/12→12/15 09/07→10/14 04/08→10/14 09/07→10/14 10/09→10/14 09/07→10/14 02/12→12/15 01/08→12/12 07/10→12/12		- ESP → 07/13; + ESP - ESP + ESP		24.4123-1730.3 24.4123-1741.3 24.4123-1730.3 24.4123-1741.3	011097 011151 011097 011151	Ø 23,8 ohne Bremsflüssigkeitsbehälter BOS Ø 23,8 ohne Bremsflüssigkeitsbehälter Ø 23,8 ohne Bremsflüssigkeitsbehälter BOS Ø 23,8 ohne Bremsflüssigkeitsbehälter
PEUGEOT - 308 II (LB_, LP_, LW_, LH_, L3_) 09/13→06/21								
 Hauptbremszylinder								
1.2 THP 110 1.2 THP 130 1.2 VTi 72 1.5 BlueHDi 100 1.5 BlueHDi 130 1.6 BlueHDi 120 1.6 GT 205 1.6 GTi 1.6 GTi PureTech 263 1.6 HDi 1.6 HDi / BlueHDi 115 1.6 HDi 100 1.6 PureTech 225 →	81 96 60 75 96 88 151 184 - 200 193 68 85 73 165	11/13→06/21 11/13→06/21 09/13→06/21 05/18→06/21 06/17→06/21 11/13→06/21 06/14→06/21 06/15→06/21 07/18→06/21 09/13→06/21 09/13→06/21 04/14→06/21 01/18→06/21				24.4155-1311.3	011053	ATE Ø 25,4 ohne Bremsflüssigkeitsbehälter















	kw			 	! #		
PEUGEOT - 308 II (LB_, LP_, LW_, LH_, L3_) 09/13→06/21							
 Hauptbremszylinder							
1.6 THP	112 - 115	09/13→06/21				24.4155-1311.3 011053	ATE Ø 25,4 ohne Bremsflüssigkeitsbehälter
1.6 THP 125	92	09/13→06/21					
1.6 THP 150	110	03/14→06/21					
1.6 THP 163	120	06/14→06/21					
1.6 VTi 115	85	05/15→06/21					
2.0 BlueHDi 150	110	11/13→06/21					
2.0 GT BlueHDi 180	130 - 133	06/14→06/21					
PEUGEOT - 308 CC (4B_) 02/09→12/15							
 Hauptbremszylinder							
1.6 16V	88 - 110	06/09→12/14		- ESP		24.4123-1730.3 011097	Ø 23,8 ohne Bremsflüssigkeitsbehälter
1.6 HDi	82 - 84	06/09→12/14				24.4123-1741.3 011151	BOS Ø 23,8 ohne Bremsflüssigkeitsbehälter
2.0 CVVT	103	07/09→12/14					
2.0 HDi	100 - 120	04/09→12/14					
1.6 16V	115	06/09→12/14		- ESP		24.4123-1730.3 011097	Ø 23,8 ohne Bremsflüssigkeitsbehälter
				09/09→		24.4123-1741.3 011151	BOS Ø 23,8 ohne Bremsflüssigkeitsbehälter
1.6 HDi	82	02/09→05/12		- ESP		24.4123-1730.3 011097	Ø 23,8 ohne Bremsflüssigkeitsbehälter
				03/09→		24.4123-1741.3 011151	BOS Ø 23,8 ohne Bremsflüssigkeitsbehälter
PEUGEOT - 308 Kasten/Schrägheck (LB_) 03/15→							
 Hauptbremszylinder							
1.5 BlueHDi 130	96	06/17→06/21				24.4155-1311.3 011053	ATE Ø 25,4 ohne Bremsflüssigkeitsbehälter
1.6 BlueHDi 120	88	03/15→06/21					
1.6 e-HDi 115	85	03/15→06/21					
PEUGEOT - 308 SW I (4E_, 4H_) 09/07→10/14							
 Hauptbremszylinder							
1.4 16V	70	09/07→10/14		- ESP		24.4123-1730.3 011097	Ø 23,8 ohne Bremsflüssigkeitsbehälter
1.6 16V	88 - 128	09/07→10/14					
1.6 HDi	66 - 80	09/07→10/14		05/08→ 04/14; + ESP		24.4123-1741.3 011151	BOS Ø 23,8 ohne Bremsflüssigkeitsbehälter
1.4 16V	72	12/09→10/14		- ESP		24.4123-1730.3 011097	Ø 23,8 ohne Bremsflüssigkeitsbehälter
1.6 Bioflex	82	03/09→10/14					
1.6 HDi	68 - 84	11/09→10/14		→ 04/14; + ESP		24.4123-1741.3 011151	BOS Ø 23,8 ohne Bremsflüssigkeitsbehälter
1.6 THP 16V	115	10/09→10/14					
2.0 HDi	110 - 120	06/09→10/14					
2.0	103	01/08→12/11		- ESP		24.4123-1730.3 011097	Ø 23,8 ohne Bremsflüssigkeitsbehälter
2.0 Bioflex	103	01/08→12/11					
2.0 HDi	100	09/07→12/12		05/08→; + ESP		24.4123-1741.3 011151	BOS Ø 23,8 ohne Bremsflüssigkeitsbehälter
2.0 HDi	103	09/07→10/14		- ESP		24.4123-1730.3 011097	Ø 23,8 ohne Bremsflüssigkeitsbehälter
				12/08→ 04/14; + ESP		24.4123-1741.3 011151	BOS Ø 23,8 ohne Bremsflüssigkeitsbehälter
PEUGEOT - 308 SW I Kasten/Kombi (4E_) 01/08→12/12							
 Hauptbremszylinder							
1.6 HDi	66 - 80	01/08→12/12		- ESP		24.4123-1730.3 011097	Ø 23,8 ohne Bremsflüssigkeitsbehälter
2.0 HDi	100	01/08→12/11		+ ESP		24.4123-1741.3 011151	BOS Ø 23,8 ohne Bremsflüssigkeitsbehälter
PEUGEOT - 308 SW II (LC_, LJ_, LR_, LX_, L4_) 03/14→06/21							
 Hauptbremszylinder							
1.2 THP 110	81	03/14→06/21		08/14→		24.4155-1311.3 011053	ATE Ø 25,4 ohne Bremsflüssigkeitsbehälter
1.2 THP 130	96	03/14→06/21				24.4155-1311.3 011053	ATE Ø 25,4 ohne Bremsflüssigkeitsbehälter
1.5 BlueHDi 100	75	04/18→06/21					
1.5 BlueHDi 130	96	06/17→06/21					
1.6 BlueHDi 100	73	04/14→06/21					
1.6 BlueHDi 120	88	03/14→06/21					
→							















	kw					! #		
PEUGEOT - 308 SW II (LC_, LJ_, LR_, LX_, L4_) 03/14→06/21								
 Hauptbremszylinder								
1.6 GT 205	151	02/15→06/21					24.4155-1311.3 011053	ATE Ø 25,4 ohne Bremsflüssigkeitsbehälter
1.6 HDi / BlueHDi 115	85	03/14→06/21						
1.6 HDi 92	68	03/14→06/21						
1.6 PureTech 225	165	01/18→06/21						
1.6 THP 125	92	03/14→06/21						
1.6 THP 150	110	03/14→06/21						
1.6 THP 155	115	03/14→06/21						
1.6 VTi	85	03/14→06/21						
2.0 BlueHDi 150	110	03/14→06/21						
2.0 GT BlueHDi 180	130 - 132	06/17→06/21						
2.0 GT HDi 180 / BlueHDi 180	133	06/14→06/21						
PEUGEOT - 308 SW II Kasten/Kombi (LC_) 04/14→								
 Hauptbremszylinder								
1.5 BlueHDi 130	96	06/17→06/21					24.4155-1311.3 011053	ATE Ø 25,4 ohne Bremsflüssigkeitsbehälter
1.6 BlueHDi	73	04/14→06/21						
PEUGEOT - 406 (8B) 08/95→01/05								
 Bremskraftverstärker								
1.6	65	11/95→05/04		Orga 08701→; → 04/04; für Linkslenker		03.7863-2804.4 300324	ATE Ø 10" pneumatisch	
1.8 16V	81	11/95→10/00		Orga 08701→; für Linkslenker		03.7863-2804.4 300324	ATE Ø 10" pneumatisch	
1.8 16V	85	10/00→05/04		für Linkslenker		03.7863-2804.4 300324	ATE Ø 10" pneumatisch	
1.8 BiFuel	85	09/00→05/04						
1.8 Bifuel	81	04/99→05/03		Orga 08701→; → 10/00; für Linkslenker		03.7863-2804.4 300324	ATE Ø 10" pneumatisch	
2.0 16V	97 - 100	11/95→06/04		Orga 08701→; → 04/04; - ESP; für Linkslenker		03.7863-2804.4 300324	ATE Ø 10" pneumatisch	
2.0 HDi 90	66	02/99→05/04		Orga 08701→; → 04/04; + ESP; für Linkslenker		03.7863-2804.4 300324	ATE Ø 10" pneumatisch	
2.0 Turbo	108	04/96→05/04						
2.2	116	07/00→05/04						
2.2 HDi	98	03/00→05/04						
2.0 16V HPi	103	05/01→05/04		→ 04/04; - ESP; für Linkslenker		03.7863-2804.4 300324	ATE Ø 10" pneumatisch	
2.0 HDi 110	79	08/01→05/04		→ 04/04; + ESP; für Linkslenker		03.7863-2804.4 300324	ATE Ø 10" pneumatisch	
2.0 HDi 110	80	06/98→08/01		Orga 08701→; + ESP; für Linkslenker		03.7863-2804.4 300324	ATE Ø 10" pneumatisch	
				Orga 08701→; - ESP; für Linkslenker		03.7863-2804.4 300324	ATE Ø 10" pneumatisch	
 Hauptbremszylinder								
1.6	65	11/95→05/04		Orga 08701→; → 04/04		03.2123-2581.3 010613	ATE Ø 23,8	
1.8	66	05/97→05/04		→ 01/99; - ABS		24.2123-1710.3 010504	Ø 23,8	
1.9 D	55	10/96→05/04		→ 01/99; + ABS		24.2123-1713.3 010505	Ø 23,8	
1.9 TD	66 - 68	01/96→05/04		02/99→; →Orga 08700; + ABS		24.2123-1741.3 010681	Ø 23,8	
3.0 24V	140	10/96→05/04		02/99→; →Orga 08700; - ABS		24.2123-1751.3 010698	Ø 23,8	
1.8 16V	81	11/95→10/00		Orga 08701→		03.2123-2581.3 010613	ATE Ø 23,8	
				→ 01/99; - ABS		24.2123-1710.3 010504	Ø 23,8	
				→ 01/99; + ABS		24.2123-1713.3 010505	Ø 23,8	
				02/99→; →Orga 08700; + ABS		24.2123-1741.3 010681	Ø 23,8	
				02/99→; →Orga 08700; - ABS		24.2123-1751.3 010698	Ø 23,8	
1.8 16V	85	10/00→05/04		- ESP		03.2123-2581.3 010613	ATE Ø 23,8	
1.8 BiFuel	85	09/00→05/04						
1.8 Bifuel	81	04/99→05/03		Orga 08701→; → 10/00		03.2123-2581.3 010613	ATE Ø 23,8	
				→Orga 08700; + ABS		24.2123-1741.3 010681	Ø 23,8	
				→Orga 08700; - ABS		24.2123-1751.3 010698	Ø 23,8	
2.0 16V	97	11/95→05/04		Orga 08701→; → 04/04; - ESP		03.2123-2581.3 010613	ATE Ø 23,8	
				→ 01/99; - ABS		24.2123-1710.3 010504	Ø 23,8	
				→ 01/99; + ABS		24.2123-1713.3 010505	Ø 23,8	
				02/99→; →Orga 08700; + ABS		24.2123-1741.3 010681	Ø 23,8	
				02/99→; →Orga 08700; - ABS		24.2123-1751.3 010698	Ø 23,8	
2.0 16V	99	01/99→08/00		02/99→; + ABS		24.2123-1741.3 010681	Ø 23,8	
				02/99→; - ABS		24.2123-1751.3 010698	Ø 23,8	
2.0 16V	100	08/00→06/04		Orga 08701→; → 04/04; - ESP		03.2123-2581.3 010613	ATE Ø 23,8	
2.0 HDi 90	66	02/99→05/04		→Orga 08700; + ABS		24.2123-1741.3 010681	Ø 23,8	
2.2	116	07/00→05/04		→Orga 08700; - ABS		24.2123-1751.3 010698	Ø 23,8	
2.2 HDi	98	03/00→05/04						
2.0 16V HPi	103	05/01→05/04		→ 04/04; - ESP		03.2123-2581.3 010613	ATE Ø 23,8	
2.0 HDi 110	79	08/01→05/04						
2.0 HDi 110	80	06/98→08/01		Orga 08701→; - ESP		03.2123-2581.3 010613	ATE Ø 23,8	
				02/99→; →Orga 08700; + ABS		24.2123-1741.3 010681	Ø 23,8	
→								









	kw			 	! #		
PEUGEOT - 406 (8B) 08/95→01/05							
 Hauptbremszylinder							
2.0 HDI 110	80	06/98→08/01		02/99→; →Orga 08700; - ABS		24.2123-1751.3 010698	Ø 23,8
2.0 Turbo 2.1 TD 12V	108 80	04/96→05/04 01/96→05/04		→ 01/99; - ABS		24.2123-1710.3 010504	Ø 23,8
				→ 01/99; + ABS		24.2123-1713.3 010505	Ø 23,8
				02/99→; →Orga 08700; + ABS		24.2123-1741.3 010681	Ø 23,8
				02/99→; →Orga 08700; - ABS		24.2123-1751.3 010698	Ø 23,8
3.0 V6	152	03/00→05/04		Orga 08701→; → 04/04		03.2123-2581.3 010613	ATE Ø 23,8
				→Orga 08700; + ABS		24.2123-1741.3 010681	Ø 23,8
				→Orga 08700; - ABS		24.2123-1751.3 010698	Ø 23,8
PEUGEOT - 406 Break (8E/F) 10/96→10/04							
 Bremskraftverstärker							
1.8 1.9 D 1.9 TD	66 55 66	05/97→10/04 10/96→10/04 10/96→10/04		Orga 08701→; → 04/04; für Linkslenker		03.7863-2804.4 300324	ATE Ø 10" pneumatisch
1.8 16V	81	10/96→10/00		Orga 08701→; für Linkslenker		03.7863-2804.4 300324	ATE Ø 10" pneumatisch
1.8 16V	85	10/00→10/04		→ 04/04; für Linkslenker		03.7863-2804.4 300324	ATE Ø 10" pneumatisch
1.8 BiFuel	85	10/00→02/04		für Linkslenker		03.7863-2804.4 300324	ATE Ø 10" pneumatisch
2.0 16V 2.0 HDI 90	97 66	10/96→10/04 02/99→10/04		Orga 08701→; → 04/04; - ESP; für Linkslenker		03.7863-2804.4 300324	ATE Ø 10" pneumatisch
				Orga 08701→; → 04/04; + ESP; für Linkslenker		03.7863-2804.4 300324	ATE Ø 10" pneumatisch
2.2 2.2 HDi	116 98	07/00→10/04 03/00→10/04		Orga 08701→; → 04/04; + ESP; für Linkslenker		03.7863-2804.4 300324	ATE Ø 10" pneumatisch
2.0 16V	99	01/99→10/00		Orga 08701→; - ESP; für Linkslenker		03.7863-2804.4 300324	ATE Ø 10" pneumatisch
				Orga 08701→; + ESP; für Linkslenker		03.7863-2804.4 300324	ATE Ø 10" pneumatisch
2.0 16V 2.0 HDi 110	100 79	10/00→10/04 08/01→10/04		→ 04/04; - ESP; für Linkslenker		03.7863-2804.4 300324	ATE Ø 10" pneumatisch
				→ 04/04; + ESP; für Linkslenker		03.7863-2804.4 300324	ATE Ø 10" pneumatisch
2.0 16V HPi	103	05/01→10/04		→ 04/04; + ESP; für Linkslenker		03.7863-2804.4 300324	ATE Ø 10" pneumatisch
2.0 HDI 110	80	02/99→04/04		Orga 08701→; → 08/01; - ESP; für Linkslenker		03.7863-2804.4 300324	ATE Ø 10" pneumatisch
				Orga 08701→; → 08/01; + ESP; für Linkslenker		03.7863-2804.4 300324	ATE Ø 10" pneumatisch
 Hauptbremszylinder							
1.8 1.9 D 1.9 TD 3.0 24V	66 55 66 140	05/97→10/04 10/96→10/04 10/96→10/04 10/96→10/04		Orga 08701→; → 04/04		03.2123-2581.3 010613	ATE Ø 23,8
				→ 01/99; - ABS		24.2123-1710.3 010504	Ø 23,8
				→ 01/99; + ABS		24.2123-1713.3 010505	Ø 23,8
				02/99→; →Orga 08700; + ABS		24.2123-1741.3 010681	Ø 23,8
				02/99→; →Orga 08700; - ABS		24.2123-1751.3 010698	Ø 23,8
1.8 16V	81	10/96→10/00		Orga 08701→		03.2123-2581.3 010613	ATE Ø 23,8
				→ 01/99; - ABS		24.2123-1710.3 010504	Ø 23,8
				→ 01/99; + ABS		24.2123-1713.3 010505	Ø 23,8
				02/99→; →Orga 08700; + ABS		24.2123-1741.3 010681	Ø 23,8
				02/99→; →Orga 08700; - ABS		24.2123-1751.3 010698	Ø 23,8
1.8 16V 2.0 16V 2.0 16V HPi 2.0 HDi 110	85 100 103 79	10/00→10/04 10/00→10/04 05/01→10/04 08/01→10/04		→ 04/04; - ESP		03.2123-2581.3 010613	ATE Ø 23,8
				Orga 08701→; → 04/04; - ESP		03.2123-2581.3 010613	ATE Ø 23,8
				→ 01/99; - ABS		24.2123-1710.3 010504	Ø 23,8
				→ 01/99; + ABS		24.2123-1713.3 010505	Ø 23,8
2.0 16V	99	01/99→10/00		02/99→; →Orga 08700; + ABS		24.2123-1741.3 010681	Ø 23,8
				02/99→; →Orga 08700; - ABS		24.2123-1751.3 010698	Ø 23,8
				Orga 08701→; - ESP		03.2123-2581.3 010613	ATE Ø 23,8
				→Orga 08700; + ABS		24.2123-1741.3 010681	Ø 23,8
2.0 HDI 110	80	02/99→04/04		→Orga 08700; - ABS		24.2123-1751.3 010698	Ø 23,8
				Orga 08701→; → 08/01; - ESP		03.2123-2581.3 010613	ATE Ø 23,8
				→Orga 08700; + ABS		24.2123-1741.3 010681	Ø 23,8
2.0 HDI 90 2.2 2.2 HDi	66 116 98	02/99→10/04 07/00→10/04 03/00→10/04		→Orga 08700; - ABS		24.2123-1751.3 010698	Ø 23,8
				→Orga 08700; + ABS		24.2123-1741.3 010681	Ø 23,8
				Orga 08701→; → 04/04; - ESP		03.2123-2581.3 010613	ATE Ø 23,8
3.0 V6	152	03/00→10/04		→Orga 08700; - ABS		24.2123-1751.3 010698	Ø 23,8
				Orga 08701→; → 04/04		03.2123-2581.3 010613	ATE Ø 23,8
				→Orga 08700; + ABS		24.2123-1741.3 010681	Ø 23,8
				→Orga 08700; - ABS		24.2123-1751.3 010698	Ø 23,8



























	kw					! #		
PEUGEOT - 406 Coupe (8C) 03/97→02/05								
 Bremskraftverstärker								
2.0 16V	97 - 99	03/97→12/04		Orga 08701→; - ESP; für Linkslenker		03.7863-2804.4	300324	ATE Ø 10" pneumatisch
2.2 HDi	98	03/00→12/04		Orga 08701→; + ESP; für Linkslenker		03.7863-2804.4	300324	ATE Ø 10" pneumatisch
2.0 16V	99	04/99→09/04		Orga 08701→; → 10/00; + ESP; für Linkslenker		03.7863-2804.4	300324	ATE Ø 10" pneumatisch
				Orga 08701→; → 10/00; - ESP; für Linkslenker		03.7863-2804.4	300324	ATE Ø 10" pneumatisch
2.0 16V	100	10/00→12/04		- ESP; für Linkslenker		03.7863-2804.4	300324	ATE Ø 10" pneumatisch
2.2	116	03/02→12/04		+ ESP; für Linkslenker		03.7863-2804.4	300324	ATE Ø 10" pneumatisch
 Hauptbremszylinder								
2.0 16V	97	03/97→12/04		Orga 08701→; - ESP		03.2123-2581.3	010613	ATE Ø 23,8
				→ 01/99; - ABS		24.2123-1710.3	010504	Ø 23,8
				→ 01/99; + ABS		24.2123-1713.3	010505	Ø 23,8
				02/99→; →Orga 08700; + ABS		24.2123-1741.3	010681	Ø 23,8
				02/99→; →Orga 08700; - ABS		24.2123-1751.3	010698	Ø 23,8
2.0 16V	99	01/99→10/00		Orga 08701→; - ESP		03.2123-2581.3	010613	ATE Ø 23,8
2.2 HDi	98	03/00→12/04		→Orga 08700; + ABS		24.2123-1741.3	010681	Ø 23,8
				→Orga 08700; - ABS		24.2123-1751.3	010698	Ø 23,8
2.0 16V	99	04/99→09/04		Orga 08701→; → 10/00; - ESP		03.2123-2581.3	010613	ATE Ø 23,8
				→Orga 08700; + ABS		24.2123-1741.3	010681	Ø 23,8
				→Orga 08700; - ABS		24.2123-1751.3	010698	Ø 23,8
2.0 16V	100	10/00→12/04		- ESP		03.2123-2581.3	010613	ATE Ø 23,8
2.2	116	03/02→12/04						
3.0 V6	152	03/00→12/04		Orga 08701→		03.2123-2581.3	010613	ATE Ø 23,8
				→Orga 08700; + ABS		24.2123-1741.3	010681	Ø 23,8
				→Orga 08700; - ABS		24.2123-1751.3	010698	Ø 23,8
3.0 V6	154	03/99→06/01		Orga 08701→		03.2123-2581.3	010613	ATE Ø 23,8
				03/00→; →Orga 08700; + ABS		24.2123-1741.3	010681	Ø 23,8
				03/00→; →Orga 08700; - ABS		24.2123-1751.3	010698	Ø 23,8
3.0 V6 24V	140	03/97→12/04		Orga 08701→		03.2123-2581.3	010613	ATE Ø 23,8
				→ 01/99; - ABS		24.2123-1710.3	010504	Ø 23,8
				→ 01/99; + ABS		24.2123-1713.3	010505	Ø 23,8
				02/99→; →Orga 08700; + ABS		24.2123-1741.3	010681	Ø 23,8
				02/99→; →Orga 08700; - ABS		24.2123-1751.3	010698	Ø 23,8
PEUGEOT - 407 (6D_) 02/04→12/11								
 Bremskraftverstärker								
1.6 HDi 110	80	05/04→12/10		für Linkslenker; →Orga 11192		03.7860-3402.4	300217	ATE Ø 10" pneumatisch
1.8 16V	92	08/05→12/10						
2.0 16V	103 - 105	09/05→12/10		Orga 12047→; für Linkslenker		03.7860-8002.4	300258	ATE Ø 10" pneumatisch
2.0 Bioflex	103	09/07→02/11						
2.0 Flex	103	10/05→02/11						
2.0 HDi	93	11/04→10/07						
2.0 HDi 135	100	05/04→10/10						
2.2 HDi 170	125	03/06→12/10						
3.0	155	03/04→12/10						
1.8	85	03/04→07/05		für Linkslenker		03.7860-3402.4	300217	ATE Ø 10" pneumatisch
2.0	100	03/04→07/05						
2.0 HDi	120	06/09→12/10		für Linkslenker		03.7860-8002.4	300258	ATE Ø 10" pneumatisch
2.0 HDi	103	06/09→12/10		Orga 12047→; für Linkslenker		03.7860-8002.4	300258	ATE Ø 10" pneumatisch
2.2 HDi	120	03/06→12/10						
2.2	116	03/04→10/06		für Linkslenker; →Orga 11283		03.7860-3402.4	300217	ATE Ø 10" pneumatisch
2.2 16V	120	08/05→12/10						
2.7 HDi	150	10/05→12/10		→Orga 11073; für Linkslenker		03.7860-3402.4	300217	ATE Ø 10" pneumatisch
 Hauptbremszylinder								
1.6 HDi 110	80	05/04→12/10				24.2122-2171.3	011122	ATE Ø 22,2
1.8	85	03/04→07/05						
1.8 16V	92	08/05→12/10						
2.0	100	03/04→07/05						
2.0 16V	103 - 105	09/05→12/10						
2.0 Bioflex	103	09/07→02/11						
2.0 Flex	103	10/05→02/11						
2.0 HDi	103 - 120	06/09→12/10		Orga 12348→		24.2123-3131.3	011123	ATE Ø 23,8
2.2 HDi	120	03/06→12/10						
2.2 HDi 170	125	03/06→12/10						
→								









	kw					! #		
PEUGEOT - 407 (6D_) 02/04→12/11								
 Hauptbremszylinder								
3.0	155	03/04→12/10		Orga 12348→		24.2123-3131.3	011123	ATE Ø 23,8
2.0 HDi	93	11/04→10/07		→Orga 11682		24.2122-2171.3	011122	ATE Ø 22,2
2.0 HDi 135	100	05/04→10/10		Orga 12348→		24.2123-3131.3	011123	ATE Ø 23,8
PEUGEOT - 407 Coupe (6C_) 10/05→								
 Bremskraftverstärker								
2.0 HDi	100	10/05→		07/07→; →Orga 11192; für Linkslenker		03.7860-3402.4	300217	ATE Ø 10" pneumatisch
				Orga 12047→; → 12/11; für Linkslenker		03.7860-8002.4	300258	ATE Ø 10" pneumatisch
2.0 HDi	120	06/09→		→ 12/11; für Linkslenker		03.7860-8002.4	300258	ATE Ø 10" pneumatisch
3.0 HDi	177	06/09→						
2.2 16V	120	10/05→		→Orga 11283; für Linkslenker		03.7860-3402.4	300217	ATE Ø 10" pneumatisch
2.7 HDi	150	10/05→		→Orga 11073; für Linkslenker		03.7860-3402.4	300217	ATE Ø 10" pneumatisch
3.0 V6	155	10/05→		→Orga 11192; für Linkslenker		03.7860-3402.4	300217	ATE Ø 10" pneumatisch
				Orga 12047→; → 12/11; für Linkslenker		03.7860-8002.4	300258	ATE Ø 10" pneumatisch
 Hauptbremszylinder								
2.0 HDi	100 - 120	10/05→		Orga 12348→; → 12/11		24.2123-3131.3	011123	ATE Ø 23,8
2.2 16V	120	10/05→						
3.0 HDi	177	06/09→						
3.0 V6	155	10/05→						
PEUGEOT - 407 SW (6E_, 6D_) 05/04→12/11								
 Bremskraftverstärker								
1.6 HDi 110	80	05/04→12/10		für Linkslenker; →Orga 11192		03.7860-3402.4	300217	ATE Ø 10" pneumatisch
1.8 16V	92	08/05→12/10		Orga 12047→; für Linkslenker		03.7860-8002.4	300258	ATE Ø 10" pneumatisch
2.0 16V	103	08/05→12/10						
2.0 Bioflex	103	01/08→12/10						
2.0 Flex	103	10/05→02/11						
2.0 HDi	93	11/04→10/07						
2.0 HDi 135	100	07/04→12/10						
2.2 HDi 170	125	03/06→12/10						
3.0	155	05/04→12/10						
1.8	85	05/04→07/05		für Linkslenker		03.7860-3402.4	300217	ATE Ø 10" pneumatisch
2.0	100	05/04→07/05						
2.0 HDi	103	08/08→12/10		Orga 12047→; für Linkslenker		03.7860-8002.4	300258	ATE Ø 10" pneumatisch
2.2 HDi	120	06/08→12/10						
2.0 HDi	120	06/09→12/10		für Linkslenker		03.7860-8002.4	300258	ATE Ø 10" pneumatisch
2.2	116	05/04→07/05		für Linkslenker; →Orga 11283		03.7860-3402.4	300217	ATE Ø 10" pneumatisch
2.2 16V	120	08/05→12/10						
2.7 HDi	150	10/05→12/10		→Orga 11073; für Linkslenker		03.7860-3402.4	300217	ATE Ø 10" pneumatisch
 Hauptbremszylinder								
1.6 HDi 110	80	05/04→12/10				24.2122-2171.3	011122	ATE Ø 22,2
1.8	85	05/04→07/05						
1.8 16V	92	08/05→12/10						
2.0	100	05/04→07/05						
2.0 16V	103	08/05→12/10						
2.0 Bioflex	103	01/08→12/10						
2.0 Flex	103	10/05→02/11						
2.0 HDi	93	11/04→10/07		→Orga 11682		24.2122-2171.3	011122	ATE Ø 22,2
2.0 HDi 135	100	07/04→12/10		Orga 12348→		24.2123-3131.3	011123	ATE Ø 23,8
2.0 HDi	103 - 120	08/08→12/10		Orga 12348→		24.2123-3131.3	011123	ATE Ø 23,8
2.2 HDi	120	06/08→12/10						
2.2 HDi 170	125	03/06→12/10						
3.0	155	05/04→12/10						
PEUGEOT - 407 SW Kasten/Kombi (6E_) 08/04→12/10								
 Bremskraftverstärker								
1.6 HDi	80	08/04→12/10		für Linkslenker; →Orga 11192		03.7860-3402.4	300217	ATE Ø 10" pneumatisch
				Orga 12047→; für Linkslenker		03.7860-8002.4	300258	ATE Ø 10" pneumatisch
2.0 HDi	103	06/09→12/10		Orga 12047→; für Linkslenker		03.7860-8002.4	300258	ATE Ø 10" pneumatisch
2.0 HDi	120	06/09→12/10		für Linkslenker		03.7860-8002.4	300258	ATE Ø 10" pneumatisch
 Hauptbremszylinder								
1.6 HDi	80	08/04→12/10				24.2122-2171.3	011122	ATE Ø 22,2
2.0 HDi	103 - 120	06/09→12/10		Orga 12348→		24.2123-3131.3	011123	ATE Ø 23,8

	kW					! #		
PEUGEOT - 508 I (8D_) 11/10→12/18								
 Bremskraftverstärker								
1.6 HDi	82 - 85	11/10→12/18		für Linkslenker; für Fahrzeuge ohne Start-Stopp-Funktion; + DSC		03.7860-7802.4	300280	ATE Ø 10" pneumatisch
1.6 THP 1.6 VTi	115 85 - 88	11/10→12/18 11/10→12/18		für Linkslenker; + DSC		03.7860-7802.4	300280	ATE Ø 10" pneumatisch
2.0 HDi	100 - 120	11/10→12/18						
2.2 HDi	150	11/10→12/18						
 Hauptbremszylinder								
1.6 BlueHDi 120	88	03/14→12/18		- DSC		03.2123-3641.3	010963	ATE Ø 23,8
1.6 HDi	82 - 85	11/10→12/18		+ DSC		24.2123-3131.3	011123	ATE Ø 23,8
1.6 THP	110 - 121	11/10→12/18						
1.6 VTi	85 - 88	11/10→12/18						
2.0 BlueHDi 150	110	04/14→12/18						
2.0 BlueHDi 180	133	04/14→12/18						
2.0 HDi	100 - 120	11/10→12/18						
2.2 HDi	150	11/10→12/18						
2.0 HDi Hybrid4 AWC	147	11/10→12/18		06/12→; - DSC		03.2123-3641.3	010963	ATE Ø 23,8
				06/12→; + DSC		24.2123-3131.3	011123	ATE Ø 23,8
PEUGEOT - 508 SW I (8E_) 11/10→12/18								
 Bremskraftverstärker								
1.6 HDi	82 - 85	11/10→12/18		für Linkslenker; für Fahrzeuge ohne Start-Stopp-Funktion; + DSC		03.7860-7802.4	300280	ATE Ø 10" pneumatisch
1.6 THP 1.6 VTi	115 85 - 88	11/10→12/18 11/10→12/18		für Linkslenker; + DSC		03.7860-7802.4	300280	ATE Ø 10" pneumatisch
2.0 HDi	100 - 120	11/10→12/18						
2.0 HDi RXH Hybrid4	147	11/10→12/18						
2.2 HDi	150	11/10→12/18						
 Hauptbremszylinder								
1.6	121	02/12→12/18		- DSC		03.2123-3641.3	010963	ATE Ø 23,8
1.6 BlueHDi 120	88	03/14→12/18		+ DSC		24.2123-3131.3	011123	ATE Ø 23,8
1.6 HDi	82 - 85	11/10→12/18						
1.6 THP	110 - 115	11/10→12/18						
1.6 VTi	85 - 88	11/10→12/18						
2.0 BlueHDi 150	110	04/14→12/18						
2.0 BlueHDi 180	133	04/14→12/18						
2.0 HDi	100 - 120	11/10→12/18						
2.0 HDi 180 RXH	133	10/14→12/18						
2.0 HDi RXH Hybrid4	147	11/10→12/18						
2.2 HDi	150	11/10→12/18						
PEUGEOT - 508 SW Kasten/Kombi (8E_) 11/11→								
 Bremskraftverstärker								
1.6 HDi	84	03/13→12/18		für Linkslenker; für Fahrzeuge ohne Start-Stopp-Funktion; + DSC		03.7860-7802.4	300280	ATE Ø 10" pneumatisch
2.0 HDi	103 - 120	03/13→12/18		für Linkslenker; + DSC		03.7860-7802.4	300280	ATE Ø 10" pneumatisch
2.2 HDi	150	11/11→						
 Hauptbremszylinder								
1.6 HDi	84	03/13→12/18		- DSC		03.2123-3641.3	010963	ATE Ø 23,8
2.0 HDi	103 - 120	03/13→12/18		+ DSC		24.2123-3131.3	011123	ATE Ø 23,8
2.2 HDi	150	11/11→						
PEUGEOT - 806 (221) 06/94→08/02								
 Hauptbremszylinder								
1.8	73	07/95→08/02		10/96→; →Orga 08206; - ABS		24.2122-1703.3	010422	Ø 22,2
				10/96→; →Orga 08206; + ABS		24.2122-1708.3	010437	Ø 22,2
				Orga 08207→; → 06/02; - ABS		24.2122-1741.3	010695	Ø 22,2
1.9 TD	66 - 68	07/95→08/02		→Orga 08206; - ABS		24.2123-1707.3	010492	Ø 23,8
				Orga 08207→; → 06/02; + ABS		24.2123-1733.3	010657	BOS Ø 23,8
→								











	kw					! #		
PEUGEOT - 806 (221) 06/94 → 08/02								
 Hauptbremszylinder								
2.0 16V	100	09/00 → 08/02		Orga 08207 →; → 06/02; - ABS		24.2123-1738.3	010658	Ø 23,8
2.0	89	06/94 → 08/02		08/94 →; → Orga 08206; - ABS		24.2123-1707.3	010492	Ø 23,8
2.0 Turbo	108	06/94 → 08/02		Orga 08207 →; → 06/02; + ABS		24.2123-1733.3	010657	BOS Ø 23,8
				Orga 08207 →; → 06/02; - ABS		24.2123-1738.3	010658	Ø 23,8
2.0 16V	97	05/98 → 09/00		10/98 →; → Orga 08206; - ABS		24.2123-1707.3	010492	Ø 23,8
				Orga 08207 →; + ABS		24.2123-1733.3	010657	BOS Ø 23,8
				Orga 08207 →; - ABS		24.2123-1738.3	010658	Ø 23,8
2.0 HDi	80	08/99 → 08/02		→ 06/02; + ABS		24.2123-1733.3	010657	BOS Ø 23,8
2.0 HDi 16V	80	08/99 → 08/02		→ 06/02; - ABS		24.2123-1738.3	010658	Ø 23,8
PEUGEOT - 807 (EB_) 06/02 →								
 Bremskraftverstärker								
2.0	100	06/02 →		Orga 10528 →; für Linkslenker; → 06/14		03.7860-2002.4	300216	ATE Ø 10" pneumatisch
2.0 HDi	100	06/06 →						
2.2	116	06/02 →						
2.0 16V	103	09/05 →		10528 → 10919; für Linkslenker		03.7860-2002.4	300216	ATE Ø 10" pneumatisch
2.0 HDi	88	02/06 →		Orga 10920 →; für Linkslenker; → 06/14		03.7860-4432.4	300313	ATE Ø 10" pneumatisch
2.2 HDi	94	06/02 →						
2.0 HDi	79	06/02 → 05/06		10528 → 10919; für Linkslenker		03.7860-2002.4	300216	ATE Ø 10" pneumatisch
2.2 HDi	100	04/04 → 05/06		Orga 10920 →; für Linkslenker		03.7860-4432.4	300313	ATE Ø 10" pneumatisch
2.0 HDi	80	04/04 →		10528 → 10919; für Linkslenker		03.7860-2002.4	300216	ATE Ø 10" pneumatisch
				Orga 10920 →; → 05/06; für Linkslenker		03.7860-4432.4	300313	ATE Ø 10" pneumatisch
 Hauptbremszylinder								
2.0	100	06/02 →		Orga 10528 →; → 06/14		03.2122-2163.3	010800	ATE Ø 22,2
2.0 HDi	88	02/06 →						
2.2	116	06/02 →						
2.2 HDi	94	06/02 →						
2.0 16V	103	09/05 →		→ 06/14		03.2122-2163.3	010800	ATE Ø 22,2
2.0 HDi	100	06/06 →						
2.0 HDi	79	06/02 → 05/06		Orga 10528 →		03.2122-2163.3	010800	ATE Ø 22,2
2.2 HDi	100	04/04 → 05/06						
2.0 HDi	80	04/04 →		Orga 10528 →; → 05/06		03.2122-2163.3	010800	ATE Ø 22,2
2.0 HDi	120	06/09 →		→ 06/14		03.2123-3421.3	010933	ATE Ø 23,8
2.2 HDi	120	06/06 →		10/07 → 06/14		03.2123-3421.3	010933	ATE Ø 23,8
2.2 HDi	125	06/06 → 06/10		10/07 →		03.2123-3421.3	010933	ATE Ø 23,8
PEUGEOT - 807 Van (EB_) 06/02 →								
 Bremskraftverstärker								
2.0 HDi	79 - 80	06/02 → 05/06		10528 → 10919; für Linkslenker		03.7860-2002.4	300216	ATE Ø 10" pneumatisch
Hdi	94	04/04 → 05/06		Orga 10920 →; für Linkslenker		03.7860-4432.4	300313	ATE Ø 10" pneumatisch
 Hauptbremszylinder								
2.0 HDi	120	05/10 →				03.2123-3421.3	010933	ATE Ø 23,8
2.0 HDi	79 - 80	06/02 → 05/06		Orga 10528 →		03.2122-2163.3	010800	ATE Ø 22,2
Hdi	94	04/04 → 05/06						
PEUGEOT - 1007 (KM_) 04/05 →								
 Hauptbremszylinder								
1.4	54	04/05 →		→ Orga 11009; - DSC		24.2122-1764.3	010851	BOS Ø 22,2
1.4 16V	65	10/05 →				24.2122-1766.3	010840	TRW Ø 22,2
1.4 HDi	50	04/05 →		→ Orga 11009; + DSC		24.2122-1767.3	010841	TRW Ø 22,2 ohne Drucksensor
1.6 16V	80	04/05 →		Orga 11010 →; → 02/11; + DSC		24.4122-1703.3	010843	TRW Ø 22,2
				Orga 11010 →; → 02/11; - DSC		24.4122-1704.3	010847	TRW Ø 22,2
1.6 HDi	80	06/07 →		→ 02/11; + DSC		24.4122-1703.3	010843	TRW Ø 22,2
				→ 02/11; - DSC		24.4122-1704.3	010847	TRW Ø 22,2
PEUGEOT - 2008 I (CU_) 03/13 →								
 Hauptbremszylinder								
1.2 PureTech 82	61	01/18 → 12/19		Orga 13384 →		24.4123-1704.3	010828	TRW Ø 23,8
				→ Orga 13383		24.4123-1734.3	011130	Ø 23,8 ohne Bremsflüssigkeitsbehälter
1.2 THP 110 / PureTech 110 →	81	01/15 →				24.4123-1704.3	010828	TRW Ø 23,8











	kw			 	! #		
PEUGEOT - 2008 I (CU_) 03/13→							
 Hauptbremszylinder							
1.2 THP 130 / PureTech 130	96	01/15→11/19				24.4123-1704.3 010828	TRW Ø 23,8
1.4 HDi	50	06/13→					
1.5 BlueHDi 100	75	05/18→					
1.5 BlueHDi 120	88	05/18→					
1.6 BlueHDi	85	07/14→					
1.6 BlueHDi 100	73	01/15→11/19					
1.6 BlueHDi 120	88	07/14→04/18					
1.6 BlueHDi 75	55	01/15→11/19					
1.6 HDi	68 - 84	03/13→					
1.6 THP 165	121	02/16→					
1.6 VTi	85 - 88	03/13→					
1.2 VTi	60	03/13→12/18		Orga 13384→		24.4123-1704.3 010828	TRW Ø 23,8
				Orga 13383→		24.4123-1734.3 011130	Ø 23,8 ohne Bremsflüssigkeitsbehälter
PEUGEOT - 2008 I Van (CU_) 03/13→							
 Hauptbremszylinder							
BlueHDi 100	75	05/18→				24.4123-1704.3 010828	TRW Ø 23,8
BlueHDi 120	88	05/18→					
PureTech 130	96	01/18→11/19					
PEUGEOT - 3008 I Großraumlimousine (0U_) 05/09→12/17							
 Bremskraftverstärker							
1.6 HDi	82	12/09→08/16		Orga 12621→; für Fahrzeuge mit Start-Stopp-Funktion		03.7860-3734.4 300317	ATE Ø 10" pneumatisch
1.6 HDi	84	03/13→08/16		für Fahrzeuge mit Start-Stopp-Funktion		03.7860-3734.4 300317	ATE Ø 10" pneumatisch
1.6 Turbo	121	05/14→08/16				03.7860-3734.4 300317	ATE Ø 10" pneumatisch
2.0 HDi Hybrid4	147	02/11→08/16					
 Hauptbremszylinder							
1.2	96	01/15→08/16				03.4153-0173.3 010815	ATE Ø 23,8
1.6 BlueHDi 120	88	05/14→08/16					
1.6 HDi	80 - 84	06/09→08/16					
1.6 HDi 115 / BlueHDi 115	85	02/13→08/16					
1.6 THP	110 - 120	06/09→08/16					
1.6 Turbo	121	05/14→08/16					
1.6 VTi	88	06/09→08/16					
2.0 HDi	100 - 120	06/09→08/16					
2.0 HDi 150 / BlueHDi 150	110	06/09→08/16					
2.0 HDi Hybrid4	147	02/11→08/16					
PEUGEOT - 3008 Van (0U_) 05/09→12/17							
 Hauptbremszylinder							
HDi	120	06/09→08/16				03.4153-0173.3 010815	ATE Ø 23,8
HDi 110	80	06/09→08/16					
HDi 150	110	06/09→08/16					
PEUGEOT - 5008 (0U_, 0E_) 06/09→03/17							
 Bremskraftverstärker							
1.6 BlueHDi 115	85	11/14→03/17		für Fahrzeuge mit Start-Stopp-Funktion		03.7860-3734.4 300317	ATE Ø 10" pneumatisch
1.6 BlueHDi 120	88	05/14→03/17					
1.6 HDi	84	03/13→03/17					
1.6 HDi	82	08/10→03/17		Orga 12656→; für Fahrzeuge mit Start-Stopp-Funktion		03.7860-3734.4 300317	ATE Ø 10" pneumatisch
 Hauptbremszylinder							
1.2	96	01/15→03/17				03.4153-0173.3 010815	ATE Ø 23,8
1.6 16V	88 - 115	09/09→03/17					
1.6 HDi	80 - 84	09/09→03/17					
2.0 HDi	120	09/09→03/17					
2.0 HDi 136 / BlueHDi 136	100	02/12→03/17					
2.0 HDi 150 / BlueHDi 150	110	06/09→03/17		09/09→		03.4153-0173.3 010815	ATE Ø 23,8









	kw					! #		
PEUGEOT - 5008 I Van (0U_) 06/09→03/17								
 Bremskraftverstärker								
HDi / e-HDi	84	03/13→03/17			für Fahrzeuge mit Start-Stopp-Funktion	03.7860-3734.4	300317	ATE Ø 10" pneumatisch
HDi	82	08/10→03/17			Orga 12656→; für Fahrzeuge mit Start-Stopp-Funktion	03.7860-3734.4	300317	ATE Ø 10" pneumatisch
 Hauptbremszylinder								
HDi / e-HDi	84	03/13→03/17				03.4153-0173.3	010815	ATE Ø 23,8
HDi	82	08/10→03/17						
HDi 136	100	02/12→03/17						
HDi 150	110	06/09→03/17						
HDi 165	120	06/09→03/17						
PEUGEOT - BOXER Bus 09/05→								
 Hauptbremszylinder								
2.0 BlueHdi 110	81	07/15→09/19			Nutzlast ab [kg] 1200 Nutzlast bis [kg] 1600; - DSC; Nutzlast-Code: 12Q / 14Q / 16Q	24.4125-1717.3	011157	BOS Ø 25,4 ohne Bremsflüssigkeitsbehälter
2.0 BlueHdi 130	96	07/15→09/19						
2.0 BlueHdi 160	120	07/15→09/19						
2.2 BlueHdi 120	88	07/19→10/23			Nutzlast ab [kg] 1200 Nutzlast bis [kg] 1600; + DSC; Nutzlast-Code: 12Q / 14Q / 16Q	24.4125-1718.3	011158	BOS Ø 25,4 ohne Bremsflüssigkeitsbehälter
2.2 BlueHdi 140	103	07/19→10/23						
2.2 BlueHdi 165	121	08/19→10/23						
					Nutzlast [kg]: 2000; - DSC; Nutzlast-Code: 20Q	24.4126-1704.3	011159	Ø 27 ohne Bremsflüssigkeitsbehälter
					Nutzlast [kg]: 2000; + DSC; Nutzlast-Code: 20Q	24.4126-1705.3	011160	Ø 27 ohne Bremsflüssigkeitsbehälter
2.2 Hdi 100	74	04/06→			Nutzlast ab [kg] 1200 Nutzlast bis [kg] 1400; + DSC; nicht für Facelift; Nutzlast-Code: 12Q / 14Q	24.4125-1701.3	010867	BOS Ø 25,4 ohne Bremsflüssigkeitsbehälter
2.2 Hdi 110	81	03/11→12/20						
2.2 Hdi 120	88	04/06→12/16						
2.2 Hdi 130	96	03/11→			Nutzlast ab [kg] 1200 Nutzlast bis [kg] 1400; - DSC; nicht für Facelift; Nutzlast-Code: 12Q / 14Q	24.4125-1702.3	010872	BOS Ø 25,4 ohne Bremsflüssigkeitsbehälter
2.2 Hdi 150	110	03/11→						
3.0 Hdi 145	107	04/10→12/13						
3.0 Hdi 160	115	04/06→12/15			Nutzlast ab [kg] 1200 Nutzlast bis [kg] 1600; - DSC; für Facelift; Nutzlast-Code: 12Q / 14Q / 16Q	24.4125-1717.3	011157	BOS Ø 25,4 ohne Bremsflüssigkeitsbehälter
3.0 Hdi 175	130	03/11→						
					Nutzlast ab [kg] 1200 Nutzlast bis [kg] 1600; + DSC; für Facelift; Nutzlast-Code: 12Q / 14Q / 16Q	24.4125-1718.3	011158	BOS Ø 25,4 ohne Bremsflüssigkeitsbehälter
					Nutzlast ab [kg] 1600 Nutzlast bis [kg] 2000; + DSC; nicht für Facelift; Nutzlast-Code: 16Q / 20Q	24.4126-1701.3	010868	BOS Ø 27 ohne Bremsflüssigkeitsbehälter
					Nutzlast ab [kg] 1600 Nutzlast bis [kg] 2000; - DSC; nicht für Facelift; Nutzlast-Code: 16Q / 20Q	24.4126-1702.3	010875	BOS Ø 27 ohne Bremsflüssigkeitsbehälter
					Nutzlast [kg]: 2000; - DSC; für Facelift; Nutzlast-Code: 20Q	24.4126-1704.3	011159	Ø 27 ohne Bremsflüssigkeitsbehälter
					Nutzlast [kg]: 2000; + DSC; für Facelift; Nutzlast-Code: 20Q	24.4126-1705.3	011160	Ø 27 ohne Bremsflüssigkeitsbehälter
PEUGEOT - BOXER Bus (230P) 03/94→12/09								
 Hauptbremszylinder								
1.9 D	51	03/94→04/02			→ S 15064995; Nutzlast [kg]: 1000; für Linkslenker; - ABS	24.2122-1715.3	010481	Ø 22,2
					S 15064996→ S 16206253; Nutzlast [kg]: 1000; + ABS	24.2125-1702.3	010482	Ø 25,4
					S 15064996→ S 16205754; Nutzlast [kg]: 1000; für Linkslenker; - ABS	24.2125-1703.3	010483	Ø 25,4
					S 16206254→; → 03/02; Nutzlast [kg]: 1000; + ABS	24.2125-1726.3	010718	Ø 25,4
1.9 TD	66 - 68	03/94→04/02			→ S 15064995; Nutzlast ab [kg] 1000 Nutzlast bis [kg] 1400; für Linkslenker; - ABS	24.2122-1715.3	010481	Ø 22,2
1.9 TD 4x4	68	07/96→04/02						
					S 15064996→ S 16206253; Nutzlast ab [kg] 1000 Nutzlast bis [kg] 1400; + ABS	24.2125-1702.3	010482	Ø 25,4
					S 15064996→ S 16205754; Nutzlast ab [kg] 1000 Nutzlast bis [kg] 1400; für Linkslenker; - ABS	24.2125-1703.3	010483	Ø 25,4
					S 16206254→; → 03/02; Nutzlast ab [kg] 1000 Nutzlast bis [kg] 1400; + ABS	24.2125-1726.3	010718	Ø 25,4
2.0 i	80	03/94→04/02			→ S 15064995; Nutzlast ab [kg] 1000 Nutzlast bis [kg] 1400; für Linkslenker; - ABS	24.2122-1715.3	010481	Ø 22,2
2.0 i 4x4	80	08/96→04/02						
					S 15064996→ S 16206253; Nutzlast ab [kg] 1000 Nutzlast bis [kg] 1400; + ABS	24.2125-1702.3	010482	Ø 25,4
					→ S 16194399; Nutzlast [kg]: 1800; + ABS	24.2125-1702.3	010482	Ø 25,4
→								













	kw			 	! #		
PEUGEOT - BOXER Bus (230P) 03/94→12/09							
 Hauptbremszylinder							
2.0 i 2.0 i 4x4	80	03/94→04/02		→ S 16205352; Nutzlast [kg]: 1800; für Linkslenker; - ABS		24.2125-1703.3 010483	Ø 25,4
	80	08/96→04/02		S 15064996→ S 16205754; Nutzlast ab [kg] 1000 Nutzlast bis [kg] 1400; für Linkslenker; - ABS		24.2125-1703.3 010483	Ø 25,4
				S 16206254→; → 03/02; Nutzlast ab [kg] 1000 Nutzlast bis [kg] 1400; + ABS		24.2125-1726.3 010718	Ø 25,4
				S 16194400→; → 03/02; Nutzlast [kg]: 1800; + ABS		24.2125-1726.3 010718	Ø 25,4
2.5 D 2.5 D 4x4	63	08/94→04/02		→ S 15064995; Nutzlast [kg]: 1400; für Linkslenker; - ABS		24.2122-1715.3 010481	Ø 22,2
	63	07/96→04/02		→ S 16194399; Nutzlast [kg]: 1800; + ABS		24.2125-1702.3 010482	Ø 25,4
				S 15064996→ S 16206253; Nutzlast [kg]: 1400; + ABS		24.2125-1702.3 010482	Ø 25,4
				→ S 16205352; Nutzlast [kg]: 1800; für Linkslenker; - ABS		24.2125-1703.3 010483	Ø 25,4
				S 15064996→ S 16205754; Nutzlast [kg]: 1400; für Linkslenker; + ABS		24.2125-1703.3 010483	Ø 25,4
				S 16206254→; → 03/02; Nutzlast [kg]: 1400; + ABS		24.2125-1726.3 010718	Ø 25,4
				S 16194400→; → 03/02; Nutzlast [kg]: 1800; + ABS		24.2125-1726.3 010718	Ø 25,4
2.5 DT	62	10/97→11/01		→ S 15064995; Nutzlast [kg]: 1400; für Linkslenker; - ABS		24.2122-1715.3 010481	Ø 22,2
				→ S 16194399; Nutzlast [kg]: 1800; + ABS		24.2125-1702.3 010482	Ø 25,4
				S 15064996→ S 16206253; Nutzlast [kg]: 1400; + ABS		24.2125-1702.3 010482	Ø 25,4
				→ S 16205352; Nutzlast [kg]: 1800; für Linkslenker; - ABS		24.2125-1703.3 010483	Ø 25,4
				S 15064996→ S 16205754; Nutzlast [kg]: 1400; für Linkslenker; + ABS		24.2125-1703.3 010483	Ø 25,4
				S 16206254→; Nutzlast [kg]: 1400; + ABS		24.2125-1726.3 010718	Ø 25,4
				S 16194400→; Nutzlast [kg]: 1800; + ABS		24.2125-1726.3 010718	Ø 25,4
2.5 TD 4x4	76	07/96→04/02		→ S 15064995; Nutzlast [kg]: 1400; für Linkslenker; - ABS		24.2122-1715.3 010481	Ø 22,2
				→ S 16194399; Nutzlast [kg]: 1800; + ABS		24.2125-1702.3 010482	Ø 25,4
				S 15064996→ S 16206253; Nutzlast [kg]: 1400; + ABS		24.2125-1702.3 010482	Ø 25,4
				→ S 16205352; Nutzlast [kg]: 1800; für Linkslenker; - ABS		24.2125-1703.3 010483	Ø 25,4
				S 15064996→ S 16205754; Nutzlast [kg]: 1400; für Linkslenker; - ABS		24.2125-1703.3 010483	Ø 25,4
				S 16206254→; → 03/02; Nutzlast [kg]: 1400; + ABS		24.2125-1726.3 010718	Ø 25,4
2.5 TDI 2.5 TDI 4x4	79	01/97→04/02		→ S 16194399; Nutzlast [kg]: 1800; + ABS		24.2125-1702.3 010482	Ø 25,4
	79	01/97→04/02		→ S 16206253; Nutzlast [kg]: 1400; + ABS		24.2125-1702.3 010482	Ø 25,4
				→ S 16205352; Nutzlast [kg]: 1800; für Linkslenker; - ABS		24.2125-1703.3 010483	Ø 25,4
				S 15064996→ S 16205754; Nutzlast [kg]: 1400; für Linkslenker; - ABS		24.2125-1703.3 010483	Ø 25,4
				S 16194400→; → 03/02; Nutzlast [kg]: 1800; + ABS		24.2125-1726.3 010718	Ø 25,4
				S 16206254→; → 03/02; Nutzlast [kg]: 1400; + ABS		24.2125-1726.3 010718	Ø 25,4
2.8 D	64	01/99→02/02		→ S 15064995; Nutzlast [kg]: 1400; für Linkslenker; - ABS		24.2122-1715.3 010481	Ø 22,2
				→ S 16194399; Nutzlast [kg]: 1800; + ABS		24.2125-1702.3 010482	Ø 25,4
				S 15064995→ S 16206253; Nutzlast [kg]: 1400; + ABS		24.2125-1702.3 010482	Ø 25,4
				→ S 16205352; Nutzlast [kg]: 1800; für Linkslenker; - ABS		24.2125-1703.3 010483	Ø 25,4
				S 15064996→ S 16205754; Nutzlast [kg]: 1400; für Linkslenker; - ABS		24.2125-1703.3 010483	Ø 25,4
				S 16206254→; Nutzlast [kg]: 1400; + ABS		24.2125-1726.3 010718	Ø 25,4









→













	kw			 	! #		
PEUGEOT - BOXER Bus (230P) 03/94→12/09							
 Hauptbremszylinder							
2.8 D	64	01/99→02/02		S 16194400→; Nutzlast [kg]: 1800; + ABS		24.2125-1726.3 010718	Ø 25,4
2.8 HDI	94	11/00→04/02		→ S 16194399; Nutzlast [kg]: 1800; + ABS		24.2125-1702.3 010482	Ø 25,4
				→ S 16206253; Nutzlast [kg]: 1400; + ABS		24.2125-1702.3 010482	Ø 25,4
				→ S 16205352; Nutzlast [kg]: 1800; für Linkslenker; - ABS		24.2125-1703.3 010483	Ø 25,4
				→ S 16205754; Nutzlast [kg]: 1400; für Linkslenker; - ABS		24.2125-1703.3 010483	Ø 25,4
				S 16206254→; → 03/02; Nutzlast [kg]: 1400; + ABS		24.2125-1726.3 010718	Ø 25,4
				S 16194400→; → 03/02; Nutzlast [kg]: 1800; + ABS		24.2125-1726.3 010718	Ø 25,4
2.8 HDi 4x4	94	10/00→04/02		→ S 15064995; Nutzlast ab [kg] 1000 Nutzlast bis [kg] 1400; für Linkslenker; - ABS		24.2122-1715.3 010481	Ø 22,2
				S 15064995→ S 16206253; Nutzlast ab [kg] 1000 Nutzlast bis [kg] 1400; + ABS		24.2125-1702.3 010482	Ø 25,4
				→ S 16194399; Nutzlast [kg]: 1800; + ABS		24.2125-1702.3 010482	Ø 25,4
				→ S 16205352; Nutzlast [kg]: 1800; für Linkslenker; - ABS		24.2125-1703.3 010483	Ø 25,4
				S 15064996→ S 16205754; Nutzlast ab [kg] 1000 Nutzlast bis [kg] 1400; für Linkslenker; - ABS		24.2125-1703.3 010483	Ø 25,4
				S 16206254→; → 03/02; Nutzlast ab [kg] 1000 Nutzlast bis [kg] 1400; + ABS		24.2125-1726.3 010718	Ø 25,4
				S 16194400→; → 03/02; Nutzlast [kg]: 1800; + ABS		24.2125-1726.3 010718	Ø 25,4
2.8 HDi All-wheel Drive	93	10/00→11/01		→ S 15064995; Nutzlast ab [kg] 1000 Nutzlast bis [kg] 1400; für Linkslenker; - ABS		24.2122-1715.3 010481	Ø 22,2
				S 15064995→ S 16206253; Nutzlast ab [kg] 1000 Nutzlast bis [kg] 1400; + ABS		24.2125-1702.3 010482	Ø 25,4
				→ S 16194399; Nutzlast [kg]: 1800; + ABS		24.2125-1702.3 010482	Ø 25,4
				→ S 16205352; Nutzlast [kg]: 1800; für Linkslenker; - ABS		24.2125-1703.3 010483	Ø 25,4
				S 15064996→ S 16205754; Nutzlast ab [kg] 1000 Nutzlast bis [kg] 1400; für Linkslenker; - ABS		24.2125-1703.3 010483	Ø 25,4
				S 16206254→; Nutzlast ab [kg] 1000 Nutzlast bis [kg] 1400; + ABS		24.2125-1726.3 010718	Ø 25,4
	S 16194400→; Nutzlast [kg]: 1800; + ABS		24.2125-1726.3 010718	Ø 25,4			
 Bremskraftregler							
1.9 D	51	03/94→04/02		→ S 16206244; Nutzlast [kg]: 1000; - ABS		24.6512-1701.3 320153	lastabhängig 2x
1.9 TD	66 - 68	03/94→04/02		→ S 16206244; Nutzlast ab [kg] 1000 Nutzlast bis [kg] 1400; - ABS		24.6512-1701.3 320153	lastabhängig 2x
1.9 TD 4x4	68	07/96→04/02					
2.0 i	80	03/94→04/02		→ S 16206244; Nutzlast ab [kg] 1000 Nutzlast bis [kg] 1800; - ABS		24.6512-1701.3 320153	lastabhängig 2x
2.0 i 4x4	80	08/96→04/02					
2.5 TD 4x4	76	07/96→04/02		→ S 16206244; Nutzlast ab [kg] 1400 Nutzlast bis [kg] 1800; - ABS		24.6512-1701.3 320153	lastabhängig 2x
2.5 TDI	79	01/97→04/02					
2.5 TDI 4x4	79	01/97→04/02					
2.8 D	64	01/99→02/02					
2.8 HDI	94	11/00→04/02					
2.8 HDi	93	10/00→11/01		11/00→; → S 16206244; Nutzlast ab [kg] 1400 Nutzlast bis [kg] 1800; - ABS		24.6512-1701.3 320153	lastabhängig 2x
PEUGEOT - BOXER Bus (244, Z_) 12/01→							
 Hauptbremszylinder							
2.0	81	12/01→06/06		→ 03/06; Nutzlast ab [kg] 1000 Nutzlast bis [kg] 1800; + ABS		24.2125-1726.3 010718	Ø 25,4
2.0 HDi	62	12/01→06/06					
2.2 HDi	74	12/01→06/06					
2.8 HDi	94 - 107	12/01→06/06					
2.8 HDi 4x4	94	12/01→06/06					
2.0 BiFuel	81	12/01→06/06		04/02→ 03/06; Nutzlast ab [kg] 1000 Nutzlast bis [kg] 1800; + ABS		24.2125-1726.3 010718	Ø 25,4
2.8 HDi	90	03/02→08/05		Nutzlast ab [kg] 1000 Nutzlast bis [kg] 1800; + ABS		24.2125-1726.3 010718	Ø 25,4
→							











	kW					! #		
PEUGEOT - BOXER Bus (244, Z_) 12/01→								
 Bremskraftregler								
2.8 HDi 4x4	94	12/01→06/06		→ 03/06; Nutzlast ab [kg] 1000 Nutzlast bis [kg] 1800; - ABS			24.6512-1701.3 320153	lastabhängig 2x
PEUGEOT - BOXER Kasten 04/06→								
 Hauptbremszylinder								
2.0 BlueHDi 110	81	03/16→09/19		Nutzlast ab [kg] 1200 Nutzlast bis [kg] 1600; - DSC; Nutzlast-Code: 12Q / 14Q / 16Q			24.4125-1717.3 011157	BOS Ø 25,4 ohne Bremsflüssigkeitsbehälter
2.0 BlueHDi 130	96	03/16→09/19		Nutzlast ab [kg] 1200 Nutzlast bis [kg] 1600; + DSC; Nutzlast-Code: 12Q / 14Q / 16Q			24.4125-1718.3 011158	BOS Ø 25,4 ohne Bremsflüssigkeitsbehälter
2.0 BlueHDi 130 4x4	96	03/16→09/19						
2.0 BlueHDi 160	120	03/16→12/23		Nutzlast [kg]: 2000; - DSC; Nutzlast-Code: 20Q			24.4126-1704.3 011159	Ø 27 ohne Bremsflüssigkeitsbehälter
2.0 BlueHDi 160 4x4	120	03/16→09/19						
2.2 BlueHDi 120	88	07/19→		Nutzlast [kg]: 2000; + DSC; Nutzlast-Code: 20Q			24.4126-1705.3 011160	Ø 27 ohne Bremsflüssigkeitsbehälter
2.2 BlueHDi 140	103	07/19→						
2.2 BlueHDi 165	121	07/19→10/23		Nutzlast ab [kg] 1200 Nutzlast bis [kg] 1400; + DSC; nicht für Facelift; Nutzlast-Code: 12Q / 14Q			24.4125-1701.3 010867	BOS Ø 25,4 ohne Bremsflüssigkeitsbehälter
2.2 BlueHDi 180	132	11/23→						
e-Boxer	100 - 200	07/21→		Nutzlast ab [kg] 1200 Nutzlast bis [kg] 1400; + DSC; nicht für Facelift; Nutzlast-Code: 12Q / 14Q			24.4125-1702.3 010872	BOS Ø 25,4 ohne Bremsflüssigkeitsbehälter
2.2 HDi 100	74	04/06→						
2.2 HDi 110	81	03/11→12/20		Nutzlast ab [kg] 1200 Nutzlast bis [kg] 1600; - DSC; für Facelift; Nutzlast-Code: 12Q / 14Q / 16Q			24.4125-1717.3 011157	BOS Ø 25,4 ohne Bremsflüssigkeitsbehälter
2.2 HDi 120	88	04/06→12/16						
2.2 HDi 130	96	03/11→		Nutzlast ab [kg] 1200 Nutzlast bis [kg] 1600; + DSC; für Facelift; Nutzlast-Code: 12Q / 14Q / 16Q			24.4125-1718.3 011158	BOS Ø 25,4 ohne Bremsflüssigkeitsbehälter
2.2 HDi 130 4x4	96	03/11→						
2.2 HDi 150	110	03/11→		Nutzlast ab [kg] 1600 Nutzlast bis [kg] 2000; + DSC; nicht für Facelift; Nutzlast-Code: 16Q / 20Q			24.4126-1701.3 010868	BOS Ø 27 ohne Bremsflüssigkeitsbehälter
2.2 HDi 150 4x4	110	03/11→						
3.0 HDi 145	107	04/10→12/13		Nutzlast ab [kg] 1600 Nutzlast bis [kg] 2000; - DSC; nicht für Facelift; Nutzlast-Code: 16Q / 20Q			24.4126-1702.3 010875	BOS Ø 27 ohne Bremsflüssigkeitsbehälter
3.0 HDi 155	115	07/06→12/15						
3.0 HDi 160	116	04/06→12/15		Nutzlast [kg]: 2000; - DSC; für Facelift; Nutzlast-Code: 20Q			24.4126-1704.3 011159	Ø 27 ohne Bremsflüssigkeitsbehälter
3.0 HDi 175	130	03/11→						
				Nutzlast [kg]: 2000; + DSC; für Facelift; Nutzlast-Code: 20Q			24.4126-1705.3 011160	Ø 27 ohne Bremsflüssigkeitsbehälter
PEUGEOT - BOXER Kasten (230L) 03/94→08/06								
 Hauptbremszylinder								
1.9 D	50	07/99→04/02		→ S 16206253; Nutzlast [kg]: 1000; + ABS			24.2125-1702.3 010482	Ø 25,4
				→ S 16205754; Nutzlast [kg]: 1000; - ABS; für Linkslenker			24.2125-1703.3 010483	Ø 25,4
				S 16206254→; → 03/02; Nutzlast [kg]: 1000; + ABS			24.2125-1726.3 010718	Ø 25,4
1.9 D	51	03/94→04/02		→ S 15064995; Nutzlast [kg]: 1000; - ABS; für Linkslenker			24.2122-1715.3 010481	Ø 22,2
				S 15064996→ S 16206253; Nutzlast [kg]: 1000; + ABS			24.2125-1702.3 010482	Ø 25,4
				S 15064996→ S 16205754; Nutzlast [kg]: 1000; - ABS; für Linkslenker			24.2125-1703.3 010483	Ø 25,4
				S 16206254→; → 03/02; Nutzlast [kg]: 1000; + ABS			24.2125-1726.3 010718	Ø 25,4
1.9 TD	66	07/99→04/02		→ S 16206253; Nutzlast ab [kg] 1000 Nutzlast bis [kg] 1400; + ABS			24.2125-1702.3 010482	Ø 25,4
				→ S 16205754; Nutzlast ab [kg] 1000 Nutzlast bis [kg] 1400; - ABS; für Linkslenker			24.2125-1703.3 010483	Ø 25,4
				S 16206254→; → 03/02; Nutzlast ab [kg] 1000 Nutzlast bis [kg] 1400; + ABS			24.2125-1726.3 010718	Ø 25,4
1.9 TD	68	03/94→04/02		→ S 15064995; Nutzlast ab [kg] 1000 Nutzlast bis [kg] 1400; - ABS; für Linkslenker			24.2122-1715.3 010481	Ø 22,2
				S 15064996→ S 16206253; Nutzlast ab [kg] 1000 Nutzlast bis [kg] 1400; + ABS			24.2125-1702.3 010482	Ø 25,4
				S 15064996→ S 16205754; Nutzlast ab [kg] 1000 Nutzlast bis [kg] 1400; - ABS; für Linkslenker			24.2125-1703.3 010483	Ø 25,4
				S 16206254→; → 03/02; Nutzlast ab [kg] 1000 Nutzlast bis [kg] 1400; + ABS			24.2125-1726.3 010718	Ø 25,4
2.0 HDI	62	08/01→04/02		→ 03/02; Nutzlast ab [kg] 1000 Nutzlast bis [kg] 1800; + ABS			24.2125-1726.3 010718	Ø 25,4
→								

	kw			 	! #		
PEUGEOT - BOXER Kasten (230L) 03/94→08/06							
 Hauptbremszylinder							
2.0 i	80	06/94→04/02	→ S 15064995; Nutzlast ab [kg] 1000 Nutzlast bis [kg] 1400; - ABS; für Linkslenker	24.2122-1715.3	010481	Ø 22,2	
			S 15064996→ S 16206253; Nutzlast ab [kg] 1000 Nutzlast bis [kg] 1400; + ABS	24.2125-1702.3	010482	Ø 25,4	
			→ S 16194399; Nutzlast [kg]: 1800; + ABS	24.2125-1702.3	010482	Ø 25,4	
			→ S 16205352; Nutzlast [kg]: 1800; - ABS; für Linkslenker	24.2125-1703.3	010483	Ø 25,4	
			S 15064996→ S 16205754; Nutzlast ab [kg] 1000 Nutzlast bis [kg] 1400; - ABS; für Linkslenker	24.2125-1703.3	010483	Ø 25,4	
			S 16206254→; → 03/02; Nutzlast ab [kg] 1000 Nutzlast bis [kg] 1400; + ABS	24.2125-1726.3	010718	Ø 25,4	
			S 16194400→; → 03/02; Nutzlast [kg]: 1800; + ABS	24.2125-1726.3	010718	Ø 25,4	
2.5 D 2.5 D 4x4	63 63	03/94→04/02 07/99→04/02	→ S 15064995; Nutzlast [kg]: 1400; - ABS; für Linkslenker	24.2122-1715.3	010481	Ø 22,2	
			→ S 16194399; Nutzlast [kg]: 1800; + ABS	24.2125-1702.3	010482	Ø 25,4	
			S 15064996→ S 16206253; Nutzlast [kg]: 1400; + ABS	24.2125-1702.3	010482	Ø 25,4	
			→ S 16205352; Nutzlast [kg]: 1800; - ABS; für Linkslenker	24.2125-1703.3	010483	Ø 25,4	
			S 15064996→ S 16205754; Nutzlast [kg]: 1400; - ABS; für Linkslenker	24.2125-1703.3	010483	Ø 25,4	
			S 16194400→; → 03/02; Nutzlast [kg]: 1800; + ABS	24.2125-1726.3	010718	Ø 25,4	
			S 16206254→; → 03/02; Nutzlast [kg]: 1400; + ABS	24.2125-1726.3	010718	Ø 25,4	
2.5 DT 2.5 TD 2.8 D	62 76 64	10/97→11/01 03/94→03/02 01/99→02/02	→ S 15064995; Nutzlast [kg]: 1400; - ABS; für Linkslenker	24.2122-1715.3	010481	Ø 22,2	
			→ S 16194399; Nutzlast [kg]: 1800; + ABS	24.2125-1702.3	010482	Ø 25,4	
			S 15064996→ S 16206253; Nutzlast [kg]: 1400; + ABS	24.2125-1702.3	010482	Ø 25,4	
			→ S 16205352; Nutzlast [kg]: 1800; - ABS; für Linkslenker	24.2125-1703.3	010483	Ø 25,4	
			S 15064996→ S 16205754; Nutzlast [kg]: 1400; - ABS; für Linkslenker	24.2125-1703.3	010483	Ø 25,4	
			S 16194400→; Nutzlast [kg]: 1800; + ABS	24.2125-1726.3	010718	Ø 25,4	
			S 16206254→; Nutzlast [kg]: 1400; + ABS	24.2125-1726.3	010718	Ø 25,4	
2.5 TDI 2.5 TDI 4x4 2.8 HDI	79 79 94	01/97→04/02 07/99→04/02 11/00→04/02	→ S 16206253; Nutzlast [kg]: 1400; + ABS	24.2125-1702.3	010482	Ø 25,4	
			→ S 16194399; Nutzlast [kg]: 1800; + ABS	24.2125-1702.3	010482	Ø 25,4	
			→ S 16205754; Nutzlast [kg]: 1400; - ABS; für Linkslenker	24.2125-1703.3	010483	Ø 25,4	
			→ S 16205352; Nutzlast [kg]: 1800; - ABS; für Linkslenker	24.2125-1703.3	010483	Ø 25,4	
			S 16194400→; → 03/02; Nutzlast [kg]: 1800; + ABS	24.2125-1726.3	010718	Ø 25,4	
			S 16206254→; → 03/02; Nutzlast [kg]: 1400; + ABS	24.2125-1726.3	010718	Ø 25,4	
 Bremskraftregler							
1.9 D	50 - 51	03/94→04/02	→ S 16206244; Nutzlast [kg]: 1000; - ABS	24.6512-1701.3	320153	lastabhängig 2x	
1.9 TD	66 - 68	03/94→04/02	→ S 16206244; Nutzlast ab [kg] 1000 Nutzlast bis [kg] 1400; - ABS	24.6512-1701.3	320153	lastabhängig 2x	
2.0 HDI	62	08/01→04/02	→ S 16206244; Nutzlast ab [kg] 1000 Nutzlast bis [kg] 1800; - ABS	24.6512-1701.3	320153	lastabhängig 2x	
2.0 i	80	06/94→04/02					
2.5 D	63	03/94→04/02	→ S 16206244; Nutzlast ab [kg] 1400 Nutzlast bis [kg] 1800; - ABS	24.6512-1701.3	320153	lastabhängig 2x	
2.5 D 4x4	63	07/99→04/02					
2.5 DT	62	10/97→11/01					
2.5 TD	76	03/94→03/02					
2.5 TDI	79	01/97→04/02					
2.5 TDI 4x4	79	07/99→04/02					
2.8 D	64	01/99→02/02					
2.8 HDI	94	11/00→04/02					
2.8 HDi	93	10/00→11/01	11/00→; → S 16206244; Nutzlast ab [kg] 1400 Nutzlast bis [kg] 1800; - ABS	24.6512-1701.3	320153	lastabhängig 2x	











	kw					! #		
PEUGEOT - BOXER Kasten (244) 12/01→								
 Hauptbremszylinder								
2.0 2.0 HDi 2.2 HDi 2.8 HDi	81 62 74 93 - 107	12/01→06/06 04/02→06/06 12/01→06/06 04/04→09/09		→ 03/06; Nutzlast ab [kg] 1000 Nutzlast bis [kg] 1800; + ABS			24.2125-1726.3 010718	Ø 25,4
2.0 BiFuel	81	12/01→06/06		04/02→ 03/06; Nutzlast ab [kg] 1000 Nutzlast bis [kg] 1800; + ABS			24.2125-1726.3 010718	Ø 25,4
2.3 HDi 2.8 HDi 2.8 HDi 4x4	93 94 94	02/07→ 12/01→06/06 12/01→06/06		Nutzlast ab [kg] 1000 Nutzlast bis [kg] 1800; + ABS			24.2125-1726.3 010718	Ø 25,4
 Bremskraftregler								
2.8 HDi 4x4	94	12/01→06/06		Nutzlast ab [kg] 1000 Nutzlast bis [kg] 1800; - ABS			24.6512-1701.3 320153	lastabhängig 2x
PEUGEOT - BOXER Pritsche/Fahrgestell 04/06→								
 Hauptbremszylinder								
2.0 BlueHDi 110 2.0 BlueHDi 130 2.0 BlueHDi 160 2.2 BlueHDi 120 2.2 BlueHDi 140 2.2 BlueHDi 165 2.2 BlueHDi 180 e-Boxer	81 96 120 88 103 121 132 100 - 200	03/16→09/19 03/16→09/19 03/16→12/23 08/19→ 08/19→ 08/19→10/23 11/23→ 11/21→		Nutzlast ab [kg] 1200 Nutzlast bis [kg] 1600; - DSC; Nutzlast-Code: 12Q / 14Q / 16Q			24.4125-1717.3 011157	BOS Ø 25,4 ohne Bremsflüssigkeitsbehälter
				Nutzlast ab [kg] 1200 Nutzlast bis [kg] 1600; + DSC; Nutzlast-Code: 12Q / 14Q / 16Q			24.4125-1718.3 011158	BOS Ø 25,4 ohne Bremsflüssigkeitsbehälter
				Nutzlast [kg]: 2000; - DSC; Nutzlast-Code: 20Q			24.4126-1704.3 011159	Ø 27 ohne Bremsflüssigkeitsbehälter
				Nutzlast [kg]: 2000; + DSC; Nutzlast-Code: 20Q			24.4126-1705.3 011160	Ø 27 ohne Bremsflüssigkeitsbehälter
2.2 HDi 100 2.2 HDi 110 2.2 HDi 120 2.2 HDi 130 2.2 HDi 150 3.0 HDi 145 3.0 HDi 155 3.0 HDi 160 3.0 HDi 175	74 81 88 96 110 107 115 116 130	04/06→ 03/11→12/20 04/06→12/16 03/11→ 03/11→ 04/10→12/13 04/06→12/15 04/06→12/15 03/11→		Nutzlast ab [kg] 1200 Nutzlast bis [kg] 1400; + DSC; nicht für Facelift; Nutzlast-Code: 12Q / 14Q			24.4125-1701.3 010867	BOS Ø 25,4 ohne Bremsflüssigkeitsbehälter
				Nutzlast ab [kg] 1200 Nutzlast bis [kg] 1400; - DSC; nicht für Facelift; Nutzlast-Code: 12Q / 14Q			24.4125-1702.3 010872	BOS Ø 25,4 ohne Bremsflüssigkeitsbehälter
				Nutzlast ab [kg] 1200 Nutzlast bis [kg] 1600; - DSC; für Facelift; Nutzlast-Code: 12Q / 14Q / 16Q			24.4125-1717.3 011157	BOS Ø 25,4 ohne Bremsflüssigkeitsbehälter
				Nutzlast ab [kg] 1200 Nutzlast bis [kg] 1600; + DSC; für Facelift; Nutzlast-Code: 12Q / 14Q / 16Q			24.4125-1718.3 011158	BOS Ø 25,4 ohne Bremsflüssigkeitsbehälter
				Nutzlast ab [kg] 1600 Nutzlast bis [kg] 2000; + DSC; nicht für Facelift; Nutzlast-Code: 16Q / 20Q			24.4126-1701.3 010868	BOS Ø 27 ohne Bremsflüssigkeitsbehälter
				Nutzlast ab [kg] 1600 Nutzlast bis [kg] 2000; - DSC; nicht für Facelift; Nutzlast-Code: 16Q / 20Q			24.4126-1702.3 010875	BOS Ø 27 ohne Bremsflüssigkeitsbehälter
				Nutzlast [kg]: 2000; - DSC; für Facelift; Nutzlast-Code: 20Q			24.4126-1704.3 011159	Ø 27 ohne Bremsflüssigkeitsbehälter
				Nutzlast [kg]: 2000; + DSC; für Facelift; Nutzlast-Code: 20Q			24.4126-1705.3 011160	Ø 27 ohne Bremsflüssigkeitsbehälter
PEUGEOT - BOXER Pritsche/Fahrgestell (244) 12/01→								
 Hauptbremszylinder								
2.0 BiFuel	81	12/01→06/06		04/02→ 03/06; Nutzlast ab [kg] 1000 Nutzlast bis [kg] 1800; + ABS			24.2125-1726.3 010718	Ø 25,4
2.0 HDi 2.2 HDi 2.8 HDi	62 74 94 - 107	12/01→06/06 12/01→06/06 12/01→06/06		→ 03/06; Nutzlast ab [kg] 1000 Nutzlast bis [kg] 1800; + ABS			24.2125-1726.3 010718	Ø 25,4
2.8 HDi 4x4	94	12/01→06/06		→ 03/06; Nutzlast ab [kg] 1000 Nutzlast bis [kg] 1800; - ABS			24.6512-1701.3 320153	lastabhängig 2x
PEUGEOT - BOXER Pritsche/Fahrgestell (ZCT_) 03/94→04/02								
 Hauptbremszylinder								
1.9 D	51	03/94→04/02		→ S 15064995; Nutzlast ab [kg] 1000 Nutzlast bis [kg] 1400; - ABS; für Linkslenker			24.2122-1715.3 010481	Ø 22,2
				S 15064996→ S 16206253; Nutzlast ab [kg] 1000 Nutzlast bis [kg] 1400; + ABS			24.2125-1702.3 010482	Ø 25,4
				S 15064996→ S 16205754; Nutzlast ab [kg] 1000 Nutzlast bis [kg] 1400; - ABS; für Linkslenker			24.2125-1703.3 010483	Ø 25,4
→								













	kw			 	! #		
PEUGEOT - BOXER Pritsche/Fahrgestell (ZCT_) 03/94 → 04/02							
 Hauptbremszylinder							
1.9 D	51	03/94 → 04/02		S 16206254 →; + ABS; Nutzlast ab [kg] 1000 Nutzlast bis [kg] 1400		24.2125-1726.3 010718	Ø 25,4
1.9 TD	66	06/94 → 04/02		12/98 →; → S 16206253; Nutzlast ab [kg] 1000 Nutzlast bis [kg] 1400; + ABS		24.2125-1702.3 010482	Ø 25,4
				12/98 →; → S 16205754; Nutzlast ab [kg] 1000 Nutzlast bis [kg] 1400; - ABS; für Linkslenker		24.2125-1703.3 010483	Ø 25,4
				S 16206254 →; → 03/02; Nutzlast ab [kg] 1000 Nutzlast bis [kg] 1400; + ABS		24.2125-1726.3 010718	Ø 25,4
1.9 TD	68	07/94 → 04/02		07/96 →; → S 16206253; Nutzlast ab [kg] 1000 Nutzlast bis [kg] 1400; + ABS		24.2125-1702.3 010482	Ø 25,4
				07/96 →; → S 16205754; Nutzlast ab [kg] 1000 Nutzlast bis [kg] 1400; - ABS; für Linkslenker		24.2125-1703.3 010483	Ø 25,4
				S 16206254 →; → 03/02; Nutzlast ab [kg] 1000 Nutzlast bis [kg] 1400; + ABS		24.2125-1726.3 010718	Ø 25,4
2.0 2.0 i	81 80	12/01 → 04/02 06/94 → 04/02		→ S 15064995; Nutzlast ab [kg] 1000 Nutzlast bis [kg] 1400; - ABS; für Linkslenker		24.2122-1715.3 010481	Ø 22,2
				S 15064996 → S 16206253; Nutzlast ab [kg] 1000 Nutzlast bis [kg] 1400; + ABS		24.2125-1702.3 010482	Ø 25,4
				→ S 16194399; Nutzlast [kg]: 1800; + ABS		24.2125-1702.3 010482	Ø 25,4
				→ S 16205352; Nutzlast [kg]: 1800; - ABS; für Linkslenker		24.2125-1703.3 010483	Ø 25,4
				S 15064996 → S 16205754; Nutzlast ab [kg] 1000 Nutzlast bis [kg] 1400; - ABS; für Linkslenker		24.2125-1703.3 010483	Ø 25,4
				S 16206254 →; → 03/02; Nutzlast ab [kg] 1000 Nutzlast bis [kg] 1400; + ABS		24.2125-1726.3 010718	Ø 25,4
				S 16194400 →; → 03/02; Nutzlast [kg]: 1800; + ABS		24.2125-1726.3 010718	Ø 25,4
2.5 D 2.5 D 4x4	63 63	03/94 → 04/02 07/99 → 04/02		→ S 15064995; Nutzlast [kg]: 1400; - ABS; für Linkslenker		24.2122-1715.3 010481	Ø 22,2
				→ S 16194399; Nutzlast [kg]: 1800; + ABS		24.2125-1702.3 010482	Ø 25,4
				S 15064996 → S 16206253; Nutzlast [kg]: 1400; + ABS		24.2125-1702.3 010482	Ø 25,4
				→ S 16205352; Nutzlast [kg]: 1800; - ABS; für Linkslenker		24.2125-1703.3 010483	Ø 25,4
				S 15064996 → S 16205754; Nutzlast [kg]: 1400; - ABS; für Linkslenker		24.2125-1703.3 010483	Ø 25,4
				S 16206254 →; → 03/02; Nutzlast [kg]: 1400; + ABS		24.2125-1726.3 010718	Ø 25,4
				S 16194400 →; → 03/02; Nutzlast [kg]: 1800; + ABS		24.2125-1726.3 010718	Ø 25,4
2.5 TDI 2.5 TDI 4x4 2.8 HDI	79 79 94	01/97 → 04/02 07/99 → 04/02 11/00 → 04/02		→ S 16206253; Nutzlast [kg]: 1400; + ABS		24.2125-1702.3 010482	Ø 25,4
				→ S 16194399; Nutzlast [kg]: 1800; + ABS		24.2125-1702.3 010482	Ø 25,4
				→ S 16205754; Nutzlast [kg]: 1400; - ABS; für Linkslenker		24.2125-1703.3 010483	Ø 25,4
				→ S 16205352; Nutzlast [kg]: 1800; - ABS; für Linkslenker		24.2125-1703.3 010483	Ø 25,4
				S 16206254 →; → 03/02; Nutzlast [kg]: 1400; + ABS		24.2125-1726.3 010718	Ø 25,4
				S 16194400 →; → 03/02; Nutzlast [kg]: 1800; + ABS		24.2125-1726.3 010718	Ø 25,4
2.8 D	64	01/99 → 02/02		→ S 15064995; Nutzlast [kg]: 1400; - ABS; für Linkslenker		24.2122-1715.3 010481	Ø 22,2
				→ S 16194399; Nutzlast [kg]: 1800; + ABS		24.2125-1702.3 010482	Ø 25,4
				S 15064996 → S 16206253; Nutzlast [kg]: 1400; + ABS		24.2125-1702.3 010482	Ø 25,4
				→ S 16205352; Nutzlast [kg]: 1800; - ABS; für Linkslenker		24.2125-1703.3 010483	Ø 25,4
				S 15064996 → S 16205754; Nutzlast [kg]: 1400; - ABS; für Linkslenker		24.2125-1703.3 010483	Ø 25,4
				S 16206254 →; Nutzlast [kg]: 1400; + ABS		24.2125-1726.3 010718	Ø 25,4
				S 16194400 →; Nutzlast [kg]: 1800; + ABS		24.2125-1726.3 010718	Ø 25,4
→							

















	kw					! #		
PEUGEOT - BOXER Pritsche/Fahrgestell (ZCT_) 03/94→04/02								
 Bremskraftregler								
1.9 D	51	03/94→04/02			→ S 16206244; Nutzlast ab [kg] 1000 Nutzlast bis [kg] 1400; - ABS		24.6512-1701.3 320153	lastabhängig 2x
1.9 TD	66	06/94→04/02			12/98→; → S 16206244; Nutzlast ab [kg] 1000 Nutzlast bis [kg] 1400; - ABS		24.6512-1701.3 320153	lastabhängig 2x
1.9 TD	68	07/94→04/02			07/96→; → S 16206244; Nutzlast ab [kg] 1000 Nutzlast bis [kg] 1400; - ABS		24.6512-1701.3 320153	lastabhängig 2x
2.0	81	12/01→04/02			→ S 16206244; Nutzlast ab [kg] 1000		24.6512-1701.3 320153	lastabhängig 2x
2.0 i	80	06/94→04/02			Nutzlast bis [kg] 1800; - ABS			
2.5 D	63	03/94→04/02			→ S 16206244; Nutzlast ab [kg] 1400		24.6512-1701.3 320153	lastabhängig 2x
2.5 D 4x4	63	07/99→04/02			Nutzlast bis [kg] 1800; - ABS			
2.5 TDI	79	01/97→04/02						
2.5 TDI 4x4	79	07/99→04/02						
2.8 D	64	01/99→02/02						
2.8 HDI	94	11/00→04/02						
2.8 HDi	93	10/00→11/01			11/00→; → S 16206244; Nutzlast ab [kg] 1400 Nutzlast bis [kg] 1800; - ABS		24.6512-1701.3 320153	lastabhängig 2x
PEUGEOT - EXPERT (224_) 10/95→12/06								
 Hauptbremszylinder								
1.6	58	02/96→09/00			→Orga 08206; - ABS; Nutzlast [kg]: 800		24.2122-1703.3 010422	Ø 22,2
1.8	74	10/96→09/00			→Orga 08206; + ABS; Nutzlast [kg]: 800		24.2122-1708.3 010437	Ø 22,2
1.9 D	51	12/03→12/06			→Orga 08206; + ABS; Nutzlast [kg]: 800		24.2122-1708.3 010437	Ø 22,2
1.9 TD	66	02/96→09/00			Orga 08207→; - ABS; Nutzlast [kg]: 800		24.2122-1741.3 010695	Ø 22,2
					→Orga 08206; - ABS; Nutzlast [kg]: 900		24.2123-1707.3 010492	Ø 23,8
					Orga 08207→; + ABS; Nutzlast [kg]: 900		24.2123-1733.3 010657	BOS Ø 23,8
					Orga 08207→; - ABS; Nutzlast [kg]: 900		24.2123-1738.3 010658	Ø 23,8
2.0	100	07/00→12/06			+ ABS		24.2123-1733.3 010657	BOS Ø 23,8
2.0 HDi	69	10/00→10/06			- ABS		24.2123-1738.3 010658	Ø 23,8
2.0 HDI	80	07/00→12/06						
2.0 HDI 16V	80	07/00→12/06						
PEUGEOT - EXPERT Kasten (222) 07/95→03/08								
 Hauptbremszylinder								
1.6	58	02/96→09/00			→Orga 08206; - ABS; Nutzlast [kg]: 800		24.2122-1703.3 010422	Ø 22,2
1.8	74	10/96→09/00			→Orga 08206; + ABS; Nutzlast [kg]: 800		24.2122-1708.3 010437	Ø 22,2
1.9 D 70	51	12/98→12/06			→Orga 08206; + ABS; Nutzlast [kg]: 800		24.2122-1708.3 010437	Ø 22,2
1.9 TD	66	02/96→09/00			Orga 08207→; - ABS; Nutzlast [kg]: 800		24.2122-1741.3 010695	Ø 22,2
					→Orga 08206; - ABS; Nutzlast [kg]: 900		24.2123-1707.3 010492	Ø 23,8
					Orga 08207→; + ABS; Nutzlast [kg]: 900		24.2123-1733.3 010657	BOS Ø 23,8
					Orga 08207→; - ABS; Nutzlast [kg]: 900		24.2123-1738.3 010658	Ø 23,8
2.0	100	09/02→12/06			+ ABS		24.2123-1733.3 010657	BOS Ø 23,8
2.0 HDI	69	07/00→12/06			- ABS		24.2123-1738.3 010658	Ø 23,8
	80							
PEUGEOT - EXPERT Kasten (VF3A_, VF3U_, VF3X_) 01/07→								
 Hauptbremszylinder								
1.6 HDi 90 16V	66	01/07→			für Linkslenker; + ESP		03.2125-0671.3 010965	ATE Ø 25,4
1.6 HDi 90 8V	66	01/07→			für Linkslenker; + ESP		03.2125-0671.3 010965	ATE Ø 25,4
2.0 16V	103	01/07→			für Linkslenker; - ESP		03.2125-0676.3 011009	ATE Ø 25,4 ohne Bremsflüssigkeitsbehälter
2.0 HDi 100	72	03/11→			für Linkslenker; - ESP		03.2125-0676.3 011009	ATE Ø 25,4 ohne Bremsflüssigkeitsbehälter
2.0 HDi 120	88	01/07→			für Rechtslenker; - ESP		24.2123-3396.3 011035	ATE Ø 23,8 ohne Bremsflüssigkeitsbehälter
2.0 HDi 120 4x4	88	01/10→			für Rechtslenker; - ESP		24.2123-3396.3 011035	ATE Ø 23,8 ohne Bremsflüssigkeitsbehälter
2.0 HDi 130	94	03/11→			für Rechtslenker; - ESP		24.2123-3396.3 011035	ATE Ø 23,8 ohne Bremsflüssigkeitsbehälter
2.0 HDi 130 4x4	94	01/12→03/16			für Rechtslenker; - ESP		24.2123-3396.3 011035	ATE Ø 23,8 ohne Bremsflüssigkeitsbehälter
2.0 HDi 140	100	01/07→			für Rechtslenker; - ESP		24.2123-3396.3 011035	ATE Ø 23,8 ohne Bremsflüssigkeitsbehälter
2.0 HDi 165	120	09/09→			für Rechtslenker; - ESP		24.2123-3396.3 011035	ATE Ø 23,8 ohne Bremsflüssigkeitsbehälter
PEUGEOT - EXPERT Pritsche/Fahrgestell 01/07→								
 Hauptbremszylinder								
1.6 HDi 90 16V	66	01/07→			für Linkslenker; + ESP		03.2125-0671.3 010965	ATE Ø 25,4
1.6 HDi 90 8V	66	01/07→			für Linkslenker; + ESP		03.2125-0671.3 010965	ATE Ø 25,4
2.0 16V	103	01/07→03/16			für Linkslenker; - ESP		03.2125-0676.3 011009	ATE Ø 25,4 ohne Bremsflüssigkeitsbehälter
2.0 HDi 120	88	01/07→			für Rechtslenker; - ESP		24.2123-3396.3 011035	ATE Ø 23,8 ohne Bremsflüssigkeitsbehälter
2.0 HDi 130	94	03/11→			für Rechtslenker; - ESP		24.2123-3396.3 011035	ATE Ø 23,8 ohne Bremsflüssigkeitsbehälter
2.0 HDi 140	100	01/07→			für Rechtslenker; - ESP		24.2123-3396.3 011035	ATE Ø 23,8 ohne Bremsflüssigkeitsbehälter
2.0 HDi 165	120	09/09→			für Rechtslenker; - ESP		24.2123-3396.3 011035	ATE Ø 23,8 ohne Bremsflüssigkeitsbehälter
PEUGEOT - EXPERT Pritsche/Fahrgestell (223) 12/95→12/06								
 Hauptbremszylinder								
1.6	58	02/96→09/00			→Orga 08206; - ABS; Nutzlast [kg]: 800		24.2122-1703.3 010422	Ø 22,2
1.9 D	51	06/98→09/01			→Orga 08206; + ABS; Nutzlast [kg]: 800		24.2122-1708.3 010437	Ø 22,2
1.9 TD	66	02/96→09/00			Orga 08207→; - ABS; Nutzlast [kg]: 800		24.2122-1741.3 010695	Ø 22,2
→								













	kW					! #		
PEUGEOT - EXPERT Pritsche/Fahrgestell (223) 12/95→12/06								
 Hauptbremszylinder								
1.6	58	02/96→09/00		→Orga 08206; - ABS; Nutzlast [kg]: 900		24.2123-1707.3	010492	Ø 23,8
1.9 D	51	06/98→09/01		Orga 08207→; + ABS; Nutzlast [kg]: 900		24.2123-1733.3	010657	BOS Ø 23,8
1.9 TD	66	02/96→09/00		Orga 08207→; - ABS; Nutzlast [kg]: 900		24.2123-1738.3	010658	Ø 23,8
2.0 HDi	69 - 80	10/00→10/06		- ABS; Nutzlast [kg]: 800		24.2122-1741.3	010695	Ø 22,2
2.0 HDI	80	10/00→10/06		+ ABS; Nutzlast [kg]: 900		24.2123-1733.3	010657	BOS Ø 23,8
	80			- ABS; Nutzlast [kg]: 900		24.2123-1738.3	010658	Ø 23,8
PEUGEOT - EXPERT TEPEE (VF3X_) 01/07→								
 Hauptbremszylinder								
1.6 HDi 90 16V	66	01/07→03/16		für Linkslenker; + ESP		03.2125-0671.3	010965	ATE Ø 25,4
1.6 HDi 90 8V	66	01/07→03/16		für Linkslenker; - ESP		03.2125-0676.3	011009	ATE Ø 25,4 ohne Bremsflüssigkeitsbehälter
2.0 16V	103	01/07→03/16						
2.0 HDi 100	72	03/11→03/16						
2.0 HDi 120	88	01/07→03/16		für Rechtslenker; - ESP		24.2123-3396.3	011035	ATE Ø 23,8 ohne Bremsflüssigkeitsbehälter
2.0 HDi 120 4x4	88	01/07→03/16						
2.0 HDi 130	94	03/11→						
2.0 HDi 130 4x4	94	03/11→03/16						
2.0 HDi 140	100	01/07→						
2.0 HDi 165	120	09/09→						
PEUGEOT - PARTNER Großraumlimousine (5_, G_) 05/96→								
 Hauptbremszylinder								
1.1	44	06/96→10/02		Orga 08610→; - ABS		03.2123-2781.3	010631	ATE Ø 23,8
1.9 D	50	06/96→12/02				24.2123-1714.3	010587	BDX Ø 23,8
				07/96→; →Orga 08609; - ABS		24.2123-1710.3	010504	Ø 23,8
				07/96→; →Orga 08609; + ABS; für Linkslenker		24.2123-1713.3	010505	Ø 23,8
				Orga 08610→; + ABS		24.2123-1715.3	010520	BDX Ø 23,8
1.4	55	06/96→12/15		Orga 08610→; → 03/08; - ABS		03.2123-2781.3	010631	ATE Ø 23,8
				07/96→; →Orga 08609; - ABS		24.2123-1710.3	010504	Ø 23,8
				07/96→; →Orga 08609; + ABS; für Linkslenker		24.2123-1713.3	010505	Ø 23,8
				Orga 08610→; → 03/08; + ABS		24.2123-1715.3	010520	BDX Ø 23,8
1.6 16V	80	07/01→03/08		- ESP / - ABS		03.2123-2781.3	010631	ATE Ø 23,8
1.6 Flexfuel	80	09/00→10/02				24.2123-1714.3	010587	BDX Ø 23,8
2.0 HDi 4x4	66	04/04→08/05		- ESP / + ABS		24.2123-1715.3	010520	BDX Ø 23,8
1.6 HDi 75	55	08/05→07/08		→ 03/08; - ABS		03.2123-2781.3	010631	ATE Ø 23,8
						24.2123-1714.3	010587	BDX Ø 23,8
				→ 03/08; + ABS		24.2123-1715.3	010520	BDX Ø 23,8
1.6 HDi 90	66	08/05→12/15		02/06→ 03/08; - ABS		03.2123-2781.3	010631	ATE Ø 23,8
						24.2123-1714.3	010587	BDX Ø 23,8
				02/06→ 03/08; + ABS		24.2123-1715.3	010520	BDX Ø 23,8
1.6 HDI 92	68	11/09→12/10		- ABS		24.2123-1714.3	010587	BDX Ø 23,8
				+ ABS / - ESP		24.2123-1715.3	010520	BDX Ø 23,8
1.8	66	05/97→12/02		Orga 08610→; - ABS		03.2123-2781.3	010631	ATE Ø 23,8
				→Orga 08609; - ABS		24.2123-1710.3	010504	Ø 23,8
				→Orga 08609; + ABS; für Linkslenker		24.2123-1713.3	010505	Ø 23,8
				Orga 08610→; + ABS		24.2123-1715.3	010520	BDX Ø 23,8
1.9 D	51	01/99→07/08		Orga 08610→; → 03/08; - ABS		03.2123-2781.3	010631	ATE Ø 23,8
				→Orga 08609; - ABS		24.2123-1710.3	010504	Ø 23,8
				→Orga 08609; + ABS; für Linkslenker		24.2123-1713.3	010505	Ø 23,8
				Orga 08610→; → 03/08; + ABS		24.2123-1715.3	010520	BDX Ø 23,8
2.0 HDI	66	02/00→07/08		→ 03/08; - ESP / - ABS		03.2123-2781.3	010631	ATE Ø 23,8
						24.2123-1714.3	010587	BDX Ø 23,8
				→ 03/08; - ESP / + ABS		24.2123-1715.3	010520	BDX Ø 23,8
Electric	28	01/98→12/01		Orga 08610→; - ABS		03.2123-2781.3	010631	ATE Ø 23,8
				→Orga 08609; - ABS		24.2123-1710.3	010504	Ø 23,8
				→Orga 08609; für Linkslenker; - ABS		24.2123-1713.3	010505	Ø 23,8
				Orga 08610→; + ABS		24.2123-1715.3	010520	BDX Ø 23,8















	kw					! #		
PEUGEOT - PARTNER Kasten/Großraumlimousine 04/08→								
 Hauptbremszylinder								
1.2 THP 1.6	81 66 -	02/16→ 04/08→		+ ESP; →Orga 14685			24.4123-1714.3 010979	TRW Ø 23,8
1.6 BlueHDi 100 1.6 BlueHDi 100 4x4 1.6 BlueHDi 120 1.6 HDi 1.6 HDi 16V 1.6 HDi 16V 4x4 1.6 HDi 4x4 1.6 HDi 90	88 73 73 88 55 - 84 66 - 68 66 84 68	04/15→ 04/15→ 04/15→ 04/08→ 04/08→ 04/12→ 07/12→ 04/10→		- ESP; →Orga 14685			24.4123-1742.3 011156	TRW Ø 23,8 ohne Bremsflüssigkeitsbehälter
1.6 HDi / BlueHDi 75	55	07/11→		01/15→; + ESP; →Orga 14685			24.4123-1714.3 010979	TRW Ø 23,8
				01/15→; - ESP; →Orga 14685			24.4123-1742.3 011156	TRW Ø 23,8 ohne Bremsflüssigkeitsbehälter
PEUGEOT - PARTNER Kasten/Großraumlimousine (5_, G_) 06/96→								
 Hauptbremszylinder								
1.1 1.8 D 1.9 D	44 43 51	06/96→09/05 06/96→12/02 06/96→12/02		Orga 08610→; - ABS			03.2123-2781.3 010631 24.2123-1714.3 010587	ATE Ø 23,8 BDX Ø 23,8
				07/96→; →Orga 08609; - ABS			24.2123-1710.3 010504	Ø 23,8
				07/96→; →Orga 08609; + ABS; für Linkslenker			24.2123-1713.3 010505	Ø 23,8
				Orga 08610→; + ABS			24.2123-1715.3 010520	BDX Ø 23,8
1.4 1.4 CNG 1.8 1.9 D 4x4	48 - 54 55 66 51	11/02→12/10 04/03→10/06 03/97→08/00 04/04→07/11		Orga 08610→; - ABS			03.2123-2781.3 010631 24.2123-1714.3 010587	ATE Ø 23,8 BDX Ø 23,8
				→Orga 08609; - ABS			24.2123-1710.3 010504	Ø 23,8
				→Orga 08609; + ABS; für Linkslenker			24.2123-1713.3 010505	Ø 23,8
				Orga 08610→; + ABS			24.2123-1715.3 010520	BDX Ø 23,8
1.4 1.9 D	55 51	06/96→12/15 06/96→12/15		Orga 08610→; → 03/08; - ABS			03.2123-2781.3 010631 24.2123-1714.3 010587	ATE Ø 23,8 BDX Ø 23,8
				07/96→; →Orga 08609; - ABS			24.2123-1710.3 010504	Ø 23,8
				07/96→; →Orga 08609; + ABS; für Linkslenker			24.2123-1713.3 010505	Ø 23,8
				Orga 08610→; → 03/08; + ABS			24.2123-1715.3 010520	BDX Ø 23,8
1.6 1.6 Bioflex	80 80	09/00→10/02 09/00→10/02		- ESP / - ABS			03.2123-2781.3 010631 24.2123-1714.3 010587	ATE Ø 23,8 BDX Ø 23,8
				- ESP / + ABS			24.2123-1715.3 010520	BDX Ø 23,8
1.6 HDi 75 2.0 HDi 4x4	55 66	08/05→07/08 04/04→08/05		- ABS			03.2123-2781.3 010631 24.2123-1714.3 010587	ATE Ø 23,8 BDX Ø 23,8
				+ ABS			24.2123-1715.3 010520	BDX Ø 23,8
1.6 HDi 90 2.0 HDi	66 66	08/05→12/15 04/00→07/08		→ 03/08; - ABS			03.2123-2781.3 010631 24.2123-1714.3 010587	ATE Ø 23,8 BDX Ø 23,8
				→ 03/08; + ABS			24.2123-1715.3 010520	BDX Ø 23,8
1.6 HDi 92	68	11/09→12/10		- ABS			24.2123-1714.3 010587	BDX Ø 23,8
				+ ABS / - ESP			24.2123-1715.3 010520	BDX Ø 23,8
Electric	25	06/96→12/02		01/98→; - ABS			03.2123-2781.3 010631 24.2123-1714.3 010587	ATE Ø 23,8 BDX Ø 23,8
				01/98→; + ABS			24.2123-1715.3 010520	BDX Ø 23,8
PEUGEOT - PARTNER ORIGIN Großraumlimousine (G_) 07/08→12/13								
 Hauptbremszylinder								
1.4 1.6 16V 1.6 HDi 75 1.9 D	55 81 55 51	07/08→12/13 09/11→12/13 08/08→12/13 08/08→12/13		- ABS			24.2123-1714.3 010587	BDX Ø 23,8
				+ ABS			24.2123-1715.3 010520	BDX Ø 23,8
PEUGEOT - PARTNER ORIGIN Kasten/Großraumlimousine (G_) 07/08→12/15								
 Hauptbremszylinder								
1.4 1.6 1.6 HDi 75 1.6 HDi 90 1.9 D Electric	55 81 55 66 51 42	08/08→12/15 09/11→12/15 08/08→12/15 08/08→12/15 08/08→12/15 01/11→12/12		- ABS			24.2123-1714.3 010587	BDX Ø 23,8
				+ ABS			24.2123-1715.3 010520	BDX Ø 23,8

	kw					! #		
PEUGEOT - PARTNER Pritsche/Fahrgestell 01/09→								
 Hauptbremszylinder								
1.6 BlueHdi 100	73	04/15→			+ ESP; →Orga 14685		24.4123-1714.3 010979	TRW Ø 23,8
1.6 HDi	55 - 66	01/09→			- ESP; →Orga 14685		24.4123-1742.3 011156	TRW Ø 23,8 ohne Bremsflüssigkeitsbehälter
1.6 HDi 16V	66	01/09→						
PEUGEOT - PARTNER Pritsche/Fahrgestell (5_, G_) 03/97→07/08								
 Hauptbremszylinder								
1.6 HDi 75	55	02/06→07/08			- ABS		03.2123-2781.3 010631	ATE Ø 23,8
					+ ABS		24.2123-1714.3 010587	BDX Ø 23,8
							24.2123-1715.3 010520	BDX Ø 23,8
1.8	66	03/97→08/00			Orga 08610→; - ABS		03.2123-2781.3 010631	ATE Ø 23,8
					→Orga 08609; - ABS		24.2123-1714.3 010587	BDX Ø 23,8
					→Orga 08609; + ABS; für Linkslenker		24.2123-1710.3 010504	Ø 23,8
					Orga 08610→; + ABS		24.2123-1713.3 010505	Ø 23,8
							24.2123-1715.3 010520	BDX Ø 23,8
1.9 D	51	01/99→07/08			Orga 08610→; → 03/08; - ABS		03.2123-2781.3 010631	ATE Ø 23,8
					→Orga 08609; - ABS		24.2123-1714.3 010587	BDX Ø 23,8
					→Orga 08609; + ABS; für Linkslenker		24.2123-1710.3 010504	Ø 23,8
					Orga 08610→; → 03/08; + ABS		24.2123-1713.3 010505	Ø 23,8
							24.2123-1715.3 010520	BDX Ø 23,8
2.0 HDi	66	11/02→07/08			→ 03/08; - ABS		03.2123-2781.3 010631	ATE Ø 23,8
					→ 03/08; + ABS		24.2123-1714.3 010587	BDX Ø 23,8
							24.2123-1715.3 010520	BDX Ø 23,8
PEUGEOT - PARTNER TEPEE 04/08→								
 Hauptbremszylinder								
1.2 THP	81	02/16→			+ ESP; →Orga 14685		24.4123-1714.3 010979	TRW Ø 23,8
1.6 BlueHdi 100	73	12/14→			- ESP; →Orga 14685		24.4123-1742.3 011156	TRW Ø 23,8 ohne Bremsflüssigkeitsbehälter
1.6 BlueHdi 100 4x4	73	04/15→						
1.6 BlueHdi 120	88	12/14→						
1.6 HDi	66 - 84	04/08→						
1.6 HDi 16V	66	04/08→						
1.6 HDi 4x4	84	07/12→						
1.6 HDi 75	55	06/08→						
1.6 HDi 90	68	04/10→						
1.6 HDi 90 4x4	68	07/12→						
1.6 VTi	66 - 80	04/08→						
1.6 HDi / BlueHdi 75	55	06/08→12/18			+ ESP; →Orga 14685		24.4123-1714.3 010979	TRW Ø 23,8
					01/15→; - ESP; →Orga 14685		24.4123-1742.3 011156	TRW Ø 23,8 ohne Bremsflüssigkeitsbehälter
1.6 VTi	81	09/08→			04/10→; + ESP; →Orga 14685		24.4123-1714.3 010979	TRW Ø 23,8
					04/10→; - ESP; →Orga 14685		24.4123-1742.3 011156	TRW Ø 23,8 ohne Bremsflüssigkeitsbehälter
1.6 VTi	88	09/09→04/16			+ ESP; →Orga 14685		24.4123-1714.3 010979	TRW Ø 23,8
					04/10→; - ESP; →Orga 14685		24.4123-1742.3 011156	TRW Ø 23,8 ohne Bremsflüssigkeitsbehälter
PEUGEOT - RCZ 03/10→12/15								
 Hauptbremszylinder								
1.6 16V	115	03/10→12/15					24.4123-1741.3 011151	BOS Ø 23,8 ohne Bremsflüssigkeitsbehälter
1.6 THP 150	110	03/11→12/15						
2.0 HDi	120	03/10→12/15			Felgenreöße [Zoll]: 18,0		24.4123-1741.3 011151	BOS Ø 23,8 ohne Bremsflüssigkeitsbehälter
PORSCHE - 911 (996) 08/97→09/05								
 Hauptbremszylinder								
3.4 Carrera	221	08/97→07/01					24.2123-1717.3 010521	Ø 23,8
3.6 Carrera	235	10/01→08/04						
3.6 Carrera S	254	02/03→08/05						
3.6 S	331	08/04→08/05						
3.4 Carrera 4	221	08/97→07/01					24.2123-1730.3 010620	Ø 23,8
3.6 Carrera 4	235	10/01→08/04						
3.6 Carrera 4S	254	02/03→07/04						

	kw			 	! #		
PORSCHE - 911 (997) 07/04 → 12/13							
 Hauptbremszylinder							
3.6 Carrera	235 - 239	07/04 → 12/08				24.2123-1766.3 010825	TRW Ø 23,8
PORSCHE - 911 Cabriolet (996) 08/97 → 08/05							
 Hauptbremszylinder							
3.4 Carrera	221	02/98 → 09/01				24.2123-1717.3 010521	Ø 23,8
3.6 Carrera	235	10/01 → 08/05					
3.6 Carrera S	254	06/02 → 08/05					
3.4 Carrera 4	221	02/98 → 09/01				24.2123-1730.3 010620	Ø 23,8
3.6 Carrera 4	235	10/01 → 08/05					
3.6 Carrera 4S	254	06/02 → 08/05					
PORSCHE - 911 Cabriolet (997) 04/05 → 12/13							
 Hauptbremszylinder							
3.6 Carrera	235 - 254	04/05 → 12/11				24.2123-1766.3 010825	TRW Ø 23,8
3.6 Carrera 4	239 - 254	04/05 → 12/12					
3.8 Carrera 4S	283	06/08 → 12/12					
PORSCHE - 911 Targa (996) 12/01 → 08/05							
 Hauptbremszylinder							
3.6	235	12/01 → 08/05				24.2123-1717.3 010521	Ø 23,8
PORSCHE - BOXSTER (986) 09/96 → 12/04							
 Hauptbremszylinder							
2.7	155	06/99 → 12/02	08/99 → 12/00			24.2123-1717.3 010521	Ø 23,8
			12/01 → 06/02			24.2123-1730.3 010620	Ø 23,8
2.7	162	08/99 → 07/02	→ 12/00			24.2123-1717.3 010521	Ø 23,8
S 3.2	185	08/99 → 07/02	12/01 → 06/02			24.2123-1730.3 010620	Ø 23,8
2.7	168	07/02 → 12/04				24.2123-1730.3 010620	Ø 23,8
S 3.2	191 - 196	07/02 → 12/04					
PORSCHE - BOXSTER (987) 06/04 → 12/13							
 Hauptbremszylinder							
2.7	176	11/04 → 12/06	→ 07/06; für Fahrzeuge ohne Keramikbremse			24.2123-1766.3 010825	TRW Ø 23,8
S 3.2	206	11/04 → 12/06					
2.7	180	07/06 → 12/09	für Fahrzeuge ohne Keramikbremse			24.2123-1766.3 010825	TRW Ø 23,8
S 3.4	217	07/06 → 12/09					
2.9	155 - 188	02/09 → 03/12	→ 09/11; für Fahrzeuge ohne Keramikbremse			24.2123-1766.3 010825	TRW Ø 23,8
S 3.4	228 - 235	06/09 → 05/12					
S 3.4	223	08/08 → 12/09	06/09 →; für Fahrzeuge ohne Keramikbremse			24.2123-1766.3 010825	TRW Ø 23,8
PORSCHE - BOXSTER Spyder (987) 09/07 → 12/11							
 Hauptbremszylinder							
3.4	235	02/10 → 12/11	für Fahrzeuge ohne Keramikbremse			24.2123-1766.3 010825	TRW Ø 23,8
3.4 RS 60	223	09/07 → 12/08	08/08 →; für Fahrzeuge ohne Keramikbremse			24.2123-1766.3 010825	TRW Ø 23,8
PORSCHE - CAYENNE (9PA) 09/02 → 12/10							
 Bremskraftverstärker							
3.0 TDI	176	02/09 → 09/10	→ 04/10; für Linkslenker			03.7868-4102.4 300250	ATE Ø 10 / 8" pneumatisch
3.6	213	02/07 → 09/10					
S 4.8	283	02/07 → 09/10					
Pedalwegsensor, Bremspedal							
3.2	177	08/03 → 09/07	10/03 → 12/06			03.0655-0006.2 370006	ATE
3.2	184	10/03 → 09/07	→ 12/06			03.0655-0006.2 370006	ATE
S 4.5	250	09/02 → 09/07					
Turbo 4.5	331	09/02 → 09/07					
 Hauptbremszylinder							
3.0 TDI	176	02/09 → 09/10	→ 04/10; für Linkslenker			03.2126-3014.3 010811	ATE Ø 27
3.6	213	02/07 → 09/10					
GTS 4.8	298	10/07 → 09/10	→ 04/10; für Rechtslenker			24.2126-3032.3 011036	ATE Ø 27 ohne Bremsflüssigkeitsbehälter
S 4.8	283	02/07 → 09/10					

	kw					! #			
PORSCHE - CAYENNE (9PA) 09/02→12/10									
 Hauptbremszylinder									
Turbo S 4.8	368 - 404	02/07→09/10		→ 04/10; für Linkslenker		03.2126-3014.3	010811	ATE Ø 27	
				→ 04/10; für Rechtslenker		24.2126-3032.3	011036	ATE Ø 27 ohne Bremsflüssigkeitsbehälter	
3.2	177	08/03→09/07		10/03→ 12/06; für Linkslenker		03.2126-3014.3	010811	ATE Ø 27	
				10/03→; für Rechtslenker; → 12/06		24.2126-3032.3	011036	ATE Ø 27 ohne Bremsflüssigkeitsbehälter	
3.2 S 4.5 Turbo 4.5	184 250 331	10/03→09/07 09/02→09/07 09/02→09/07		→ 12/06; für Linkslenker		03.2126-3014.3	010811	ATE Ø 27	
				für Rechtslenker; → 12/06		24.2126-3032.3	011036	ATE Ø 27 ohne Bremsflüssigkeitsbehälter	
Turbo 4.8 Turbo S 4.5	373 368 - 383	09/07→12/09 01/04→09/07		für Linkslenker		03.2126-3014.3	010811	ATE Ø 27	
				für Rechtslenker		24.2126-3032.3	011036	ATE Ø 27 ohne Bremsflüssigkeitsbehälter	
PORSCHE - CAYMAN (987) 11/05→12/13									
 Hauptbremszylinder									
2.7 S 3.4	180 217	07/06→12/09 11/05→12/09		für Fahrzeuge ohne Keramikbremse		24.2123-1766.3	010825	TRW Ø 23,8	
2.9 R 3.4 S 3 4 Sport S 3.4	155 - 195 243 223 223 235	02/09→06/13 11/10→12/12 08/08→12/12 08/08→12/12 02/09→06/13		→ 05/12; für Fahrzeuge ohne Keramikbremse		24.2123-1766.3	010825	TRW Ø 23,8	
RENAULT - 19 II Cabriolet (D53_, 853_) 04/92→06/01									
 Hauptbremszylinder									
1.8	86	01/95→06/01		→ 03/95; - ABS		03.2120-2031.3	010106	ATE Ø 20,6	
				→ 03/95; + ABS		24.2120-1725.3	010579	BDX Ø 20,6	
RENAULT - AVANTIME (DE0_) 09/01→05/03									
 Hauptbremszylinder									
2.0 16V Turbo	120	11/01→05/03				03.2123-1486.3	010488	Ø 23,8	
2.2 dCi 3.0 V6	110 152	05/02→05/03 09/01→05/03		- ASR		03.2123-1486.3	010488	Ø 23,8	
				+ ASR		03.2123-2621.3	010701	ATE Ø 23,8	
RENAULT - CAPTUR I (J5_, H5_) 06/13→									
 Hauptbremszylinder									
0.9 TCe 90 1.2 T	66 83 - 85	06/13→ 06/13→		für Linkslenker		24.4123-1723.3	011074	Ø 23,8 ohne Bremsflüssigkeitsbehälter	
1.2 TCe 1.2 TCe 120	97 87 - 88	02/18→ 06/13→		für Rechtslenker		24.4123-1724.3	011075	TRW Ø 23,8 ohne Bremsflüssigkeitsbehälter	
1.3 TCe 130	96	03/18→							
1.3 TCe 150	110	03/18→							
1.5 dCi	63	06/13→							
1.5 dCi 110	81	01/15→							
1.5 dCi 90	66	06/13→							
1.6	84	02/18→							
RENAULT - CLIO II (BB_, CB_) 03/98→12/16									
 Bremskraftverstärker									
1.0 1.2 1.2 LPG 1.4 1.5 dCi 1.6 1.6 16V 1.6 Flex 1.9 D	40 43 43 - 44 55 47 66 - 81 79 81 47 - 48	02/00→05/01 09/98→02/10 09/98→06/09 09/98→05/05 06/05→12/10 09/98→02/09 09/98→04/05 05/00→12/06 09/98→05/05		für Linkslenker; - ABS		03.7750-1332.4	300155	ATE Ø 9" pneumatisch	
1.2 16V	55	06/01→08/16		→ 10/03; für Linkslenker; - ABS		03.7750-1332.4	300155	ATE Ø 9" pneumatisch	
				→ 10/03; + ESP		03.7853-0702.4	300195	ATE Ø 9" pneumatisch	
1.4 16V	70	10/99→09/04		→ 07/00; für Linkslenker; - ABS		03.7750-1332.4	300155	ATE Ø 9" pneumatisch	
				→ 07/00; + ESP		03.7853-0702.4	300195	ATE Ø 9" pneumatisch	
1.4 16V 1.5 dCi	72 42 - 74	02/00→07/08 06/01→12/12		für Linkslenker; - ABS		03.7750-1332.4	300155	ATE Ø 9" pneumatisch	
				+ ESP		03.7853-0702.4	300195	ATE Ø 9" pneumatisch	
→									

	kw					! #		
RENAULT - CLIO II (BB_, CB_) 03/98→12/16								
 Bremskraftverstärker								
1.9 dTi	59	12/99→05/05		02/00→; für Linkslenker; - ABS			03.7750-1332.4 300155	ATE Ø 9" pneumatisch
 Hauptbremszylinder								
1.0	40	02/00→05/01		für Linkslenker; - ABS			03.2120-4381.3 010526	ATE Ø 20,6
1.2	43	09/98→02/10		für Linkslenker; + ABS			03.2120-4461.3 010571	ATE Ø 20,6
1.2 LPG	43 - 44	09/98→06/09		für Linkslenker; + ESP			03.2120-4468.3 010789	ATE Ø 20,6
1.4	55	09/98→05/05						
1.4 16V	72	02/00→07/08						
1.5 dCi	42 - 74	06/01→12/12						
1.6	66 - 81	09/98→02/09						
1.6 16V	79	09/98→04/05						
1.6 Flex	81	05/00→12/06						
1.9 D	47 - 48	09/98→05/05						
1.2 16V	55	06/01→08/16		→ 10/03; für Linkslenker; - ABS			03.2120-4381.3 010526	ATE Ø 20,6
				→ 10/03; für Linkslenker; + ABS			03.2120-4461.3 010571	ATE Ø 20,6
				→ 10/03; für Linkslenker; + ESP			03.2120-4468.3 010789	ATE Ø 20,6
1.4 16V	70	10/99→09/04		→ 07/00; für Linkslenker; - ABS			03.2120-4381.3 010526	ATE Ø 20,6
				→ 07/00; für Linkslenker; + ABS			03.2120-4461.3 010571	ATE Ø 20,6
				→ 07/00; für Linkslenker; + ESP			03.2120-4468.3 010789	ATE Ø 20,6
1.9 dTi	59	12/99→05/05		02/00→; für Linkslenker; - ABS			03.2120-4381.3 010526	ATE Ø 20,6
				02/00→; für Linkslenker; + ABS			03.2120-4461.3 010571	ATE Ø 20,6
				02/00→; für Linkslenker; + ESP			03.2120-4468.3 010789	ATE Ø 20,6
2.0 16V Sport	124 - 132	02/00→06/09		für Linkslenker			03.2122-1926.3 010916	ATE Ø 22,2
RENAULT - CLIO II Kasten/Schrägheck (SB0/1/2_) 09/98→								
 Bremskraftverstärker								
1.2	44	03/99→10/03		- ABS			03.7750-1332.4 300155	ATE Ø 9" pneumatisch
1.9 D	40 - 48	03/99→05/01						
1.9 DTi	59	02/00→05/01						
1.5 dCi	48 - 60	06/01→		für Linkslenker; → 12/12; - ABS			03.7750-1332.4 300155	ATE Ø 9" pneumatisch
				→ 12/12; + ESP			03.7853-0702.4 300195	ATE Ø 9" pneumatisch
1.5 dCi	59	06/01→10/04		für Linkslenker; - ABS			03.7750-1332.4 300155	ATE Ø 9" pneumatisch
				+ ESP			03.7853-0702.4 300195	ATE Ø 9" pneumatisch
1.5 dCi	47	06/05→12/10		für Linkslenker; - ABS			03.7750-1332.4 300155	ATE Ø 9" pneumatisch
1.6	79	11/03→		→ 04/05; + ESP			03.7853-0702.4 300195	ATE Ø 9" pneumatisch
 Hauptbremszylinder								
1.2	44	03/99→10/03		- ABS			03.2120-4381.3 010526	ATE Ø 20,6
1.9 D	40 - 48	03/99→05/01		- ESP			03.2120-4461.3 010571	ATE Ø 20,6
1.9 DTi	59	02/00→05/01		+ ESP			03.2120-4468.3 010789	ATE Ø 20,6
1.5 dCi	48 - 60	06/01→		für Linkslenker; → 12/12; - ABS			03.2120-4381.3 010526	ATE Ø 20,6
				für Linkslenker; → 12/12; - ESP			03.2120-4461.3 010571	ATE Ø 20,6
				für Linkslenker; → 12/12; + ESP			03.2120-4468.3 010789	ATE Ø 20,6
1.5 dCi	59	06/01→10/04		für Linkslenker; - ABS			03.2120-4381.3 010526	ATE Ø 20,6
				für Linkslenker; - ESP			03.2120-4461.3 010571	ATE Ø 20,6
				für Linkslenker; + ESP			03.2120-4468.3 010789	ATE Ø 20,6
1.5 dCi	47	06/05→12/10		für Linkslenker; - ABS			03.2120-4381.3 010526	ATE Ø 20,6
				für Linkslenker; + ABS			03.2120-4461.3 010571	ATE Ø 20,6
				für Linkslenker; + ESP			03.2120-4468.3 010789	ATE Ø 20,6
1.6	79	11/03→		→ 04/05; - ABS			03.2120-4381.3 010526	ATE Ø 20,6
				→ 04/05; - ESP			03.2120-4461.3 010571	ATE Ø 20,6
				→ 04/05; + ESP			03.2120-4468.3 010789	ATE Ø 20,6
RENAULT - CLIO III (BR0/1, CR0/1) 01/05→12/14								
 Bremskraftverstärker								
1.2	57	10/05→12/12		12/07→; für Linkslenker; + ABS			03.7863-1232.4 300314	ATE Ø 10" pneumatisch
1.2 16V	43 - 48	06/05→12/14		→ 11/07; für Linkslenker; + ABS			03.7863-4502.4 300230	ATE Ø 10" pneumatisch
1.4 16V	72	06/05→12/12						
1.5 dCi	50 - 76	06/05→12/12						
1.6	79	09/05→12/10						
→								

RENAULT - CLIO III (BR0/1, CR0/1) 01/05→12/14

 **Bremskraftverstärker**

1.2 16V	55 - 74	06/05→12/14		12/07→; für Linkslenker; → 12/12; + ABS	03.7863-1232.4	300314	ATE Ø 10" pneumatisch
1.5 dCi	78	06/05→12/14		→ 11/07; für Linkslenker; + ABS	03.7863-4502.4	300230	ATE Ø 10" pneumatisch
1.6 16V	82	06/05→12/14					
2.0 16V	102	09/06→12/14					
1.2 16V	76	09/10→12/14		→ 12/12; für Linkslenker; + ABS	03.7863-1232.4	300314	ATE Ø 10" pneumatisch
1.5 dCi	55 - 65	08/10→12/14					
1.6 16V GT	94	06/09→12/14					
1.2 16V Hi-Flex	55	07/08→12/14		für Linkslenker; + ABS	03.7863-1232.4	300314	ATE Ø 10" pneumatisch
1.2 Ethanol	55	07/08→12/12					
1.5 dCi	48	05/05→07/10		→ 10/06; für Linkslenker; + ABS	03.7863-4502.4	300230	ATE Ø 10" pneumatisch
1.5 dCi	60	11/07→12/12		12/07→; für Linkslenker; + ABS	03.7863-1232.4	300314	ATE Ø 10" pneumatisch
1.6 16V	65	06/05→10/07		für Linkslenker; + ABS	03.7863-4502.4	300230	ATE Ø 10" pneumatisch
2.0 16V Sport	148	09/08→12/14		für Linkslenker; → 12/12	03.7860-3702.4	300305	ATE Ø 9" pneumatisch
2.0 16V Sport	145	02/06→12/12		für Linkslenker	03.7860-3702.4	300305	ATE Ø 9" pneumatisch

 **Hauptbremszylinder**

1.2	57	10/05→12/12		- ABS	03.2123-2821.3	010944	ATE Ø 23,8
1.2 16V	43 - 58	06/05→12/14		12/07→; für Linkslenker; + ESP	03.2123-2923.3	010791	ATE Ø 23,8
1.4 16V	72	06/05→12/12		→ 11/07; für Linkslenker; - ESP	03.2123-3241.3	010882	ATE Ø 23,8
1.5 dCi	50 - 76	06/05→12/12		→ 11/07; für Linkslenker; + ESP	03.2123-3493.3	010792	ATE Ø 23,8
1.6	79	09/05→12/10					
1.2 16V	76	09/10→12/14		→ 12/12; - ABS	03.2123-2821.3	010944	ATE Ø 23,8
1.5 dCi	55 - 65	08/10→12/14		für Linkslenker; → 12/12; + ESP	03.2123-2923.3	010791	ATE Ø 23,8
1.6 16V GT	94	06/09→12/14					
1.2 16V	55 - 74	06/05→12/14		→ 12/12; - ABS	03.2123-2821.3	010944	ATE Ø 23,8
1.5 dCi	78	06/05→12/14		12/07→; für Linkslenker; → 12/12; + ESP	03.2123-2923.3	010791	ATE Ø 23,8
1.6 16V	82	06/05→12/14		→ 11/07; für Linkslenker; - ESP	03.2123-3241.3	010882	ATE Ø 23,8
2.0 16V	102	09/06→12/14		→ 11/07; für Linkslenker; + ESP	03.2123-3493.3	010792	ATE Ø 23,8
1.2 16V Hi-Flex	55	07/08→12/14		- ABS	03.2123-2821.3	010944	ATE Ø 23,8
1.2 Ethanol	55	07/08→12/12		für Linkslenker; + ESP	03.2123-2923.3	010791	ATE Ø 23,8
1.5 dCi	48	05/05→07/10		→ 10/06; - ABS	03.2123-2821.3	010944	ATE Ø 23,8
				→ 10/06; für Linkslenker; - ESP	03.2123-3241.3	010882	ATE Ø 23,8
				→ 10/06; für Linkslenker; + ESP	03.2123-3493.3	010792	ATE Ø 23,8
1.5 dCi	60	11/07→12/12		- ABS	03.2123-2821.3	010944	ATE Ø 23,8
				12/07→; für Linkslenker; + ESP	03.2123-2923.3	010791	ATE Ø 23,8
1.6 16V	65	06/05→10/07		- ABS	03.2123-2821.3	010944	ATE Ø 23,8
				für Linkslenker; - ESP	03.2123-3241.3	010882	ATE Ø 23,8
				für Linkslenker; + ESP	03.2123-3493.3	010792	ATE Ø 23,8
2.0 16V Sport	148	09/08→12/14		→ 12/12; - ABS	03.2123-2821.3	010944	ATE Ø 23,8
				für Linkslenker; → 12/12	03.2123-3493.3	010792	ATE Ø 23,8
2.0 16V Sport	145	02/06→12/12		- ABS	03.2123-2821.3	010944	ATE Ø 23,8
				für Linkslenker	03.2123-3493.3	010792	ATE Ø 23,8













RENAULT - CLIO III Grandtour (KR0/1_) 11/07→













 **Bremskraftverstärker**













1.2 16V	55 - 76	11/07→12/14		für Linkslenker	03.7863-4502.4	300230	ATE Ø 10" pneumatisch
1.2 16V Hi-Flex	55 - 58	11/07→12/14					
1.4 16V	72	11/07→12/12					
1.5 dCi	48 - 78	11/07→12/12					
1.6 16V	80 - 94	11/07→12/12					













 **Hauptbremszylinder**













1.2 16V	55 - 76	11/07→12/14		- ABS	03.2123-2821.3	010944	ATE Ø 23,8
1.2 16V Hi-Flex	55 - 58	11/07→12/14		- ESP	03.2123-3241.3	010882	ATE Ø 23,8
				+ ESP	03.2123-3493.3	010792	ATE Ø 23,8
1.5 dCi	48 - 78	11/07→12/12					
1.6 16V	80 - 82	11/07→12/12					
1.4 16V	72	11/07→12/12		- ESP	03.2123-3241.3	010882	ATE Ø 23,8
				+ ESP	03.2123-3493.3	010792	ATE Ø 23,8
→							









	kw					! #		
RENAULT - CLIO III Grandtour (KR0/1_) 11/07→								
 Hauptbremszylinder								
1.6 16V	94	11/07→12/12		+ ESP			03.2123-2923.3 010791	ATE Ø 23,8
RENAULT - CLIO III Kasten/Schrägheck (SB_, SR_) 06/05→								
 Bremskraftverstärker								
1.2	55	11/05→12/14		12/07→; für Linkslenker; → 12/12; + ABS		03.7863-1232.4 300314		ATE Ø 10" pneumatisch
				→ 11/07; für Linkslenker; + ABS		03.7863-4502.4 300230		ATE Ø 10" pneumatisch
1.2	74	11/07→12/11		12/07→; für Linkslenker; + ABS		03.7863-1232.4 300314		ATE Ø 10" pneumatisch
1.5 dCi	50 - 63	06/05→07/10		→ 11/07; für Linkslenker; + ABS		03.7863-4502.4 300230		ATE Ø 10" pneumatisch
1.2 Hi-Flex	58	11/07→12/09		für Linkslenker		03.7863-4502.4 300230		ATE Ø 10" pneumatisch
1.5 dCi	55	08/10→12/14		für Linkslenker; + ABS		03.7863-1232.4 300314		ATE Ø 10" pneumatisch
1.5 dCi	78	10/05→10/07		für Linkslenker; + ABS		03.7863-4502.4 300230		ATE Ø 10" pneumatisch
1.5 dCi	65	08/10→12/14		→ 12/12; für Linkslenker; + ABS		03.7863-1232.4 300314		ATE Ø 10" pneumatisch
 Hauptbremszylinder								
1.2	55	11/05→12/14		→ 12/12; - ABS		03.2123-2821.3 010944		ATE Ø 23,8
				12/07→; für Linkslenker; → 12/12; + ESP		03.2123-2923.3 010791		ATE Ø 23,8
				→ 11/07; für Linkslenker; - ESP		03.2123-3241.3 010882		ATE Ø 23,8
				→ 11/07; für Linkslenker; + ESP		03.2123-3493.3 010792		ATE Ø 23,8
1.2	74	11/07→12/11		- ABS		03.2123-2821.3 010944		ATE Ø 23,8
1.5 dCi	50 - 63	06/05→07/10		12/07→; für Linkslenker; + ESP		03.2123-2923.3 010791		ATE Ø 23,8
				→ 11/07; für Linkslenker; - ESP		03.2123-3241.3 010882		ATE Ø 23,8
				→ 11/07; für Linkslenker; + ESP		03.2123-3493.3 010792		ATE Ø 23,8
1.2 Hi-Flex	58	11/07→12/09		- ABS		03.2123-2821.3 010944		ATE Ø 23,8
				- ESP		03.2123-3241.3 010882		ATE Ø 23,8
				+ ESP		03.2123-3493.3 010792		ATE Ø 23,8
1.5 dCi	55	08/10→12/14		- ABS		03.2123-2821.3 010944		ATE Ø 23,8
				für Linkslenker; + ESP		03.2123-2923.3 010791		ATE Ø 23,8
1.5 dCi	78	10/05→10/07		- ABS		03.2123-2821.3 010944		ATE Ø 23,8
				für Linkslenker; - ESP		03.2123-3241.3 010882		ATE Ø 23,8
				für Linkslenker; + ESP		03.2123-3493.3 010792		ATE Ø 23,8
1.5 dCi	65	08/10→12/14		→ 12/12; - ABS		03.2123-2821.3 010944		ATE Ø 23,8
				für Linkslenker; → 12/12; + ESP		03.2123-2923.3 010791		ATE Ø 23,8
RENAULT - CLIO IV (BH_) 11/12→08/21								
 Hauptbremszylinder								
0.9 TCe 75	56	05/18→08/21		für Linkslenker		24.4120-1771.3 011076		Ø 20,6 ohne Bremsflüssigkeitsbehälter
0.9 TCe 90	66	11/12→08/21						
0.9 TCe 90 LPG	66	06/16→08/21						
1.2 16V	54 - 55	11/12→08/21						
1.2 LPG	53	01/14→08/21						
1.2 LPG 16V	54	11/12→06/15						
1.2 TCe 120	87 - 88	03/13→08/21		für Linkslenker		24.4123-1723.3 011074		Ø 23,8 ohne Bremsflüssigkeitsbehälter
				für Rechtslenker		24.4123-1724.3 011075		TRW Ø 23,8 ohne Bremsflüssigkeitsbehälter
1.5 dCi	62 - 63	11/12→08/21		für Linkslenker; Schaltgetriebe		24.4120-1771.3 011076		Ø 20,6 ohne Bremsflüssigkeitsbehälter
1.5 dCi 110	81	06/16→08/21		für Linkslenker; Automatikgetriebe		24.4123-1723.3 011074		Ø 23,8 ohne Bremsflüssigkeitsbehälter
1.5 dCi 90	66	11/12→08/21		für Rechtslenker; Automatikgetriebe		24.4123-1724.3 011075		TRW Ø 23,8 ohne Bremsflüssigkeitsbehälter
1.5 dCi 75	55	11/12→08/21		für Linkslenker; Schaltgetriebe		24.4120-1771.3 011076		Ø 20,6 ohne Bremsflüssigkeitsbehälter
RENAULT - CLIO IV Grandtour (KH_) 11/12→08/21								
 Hauptbremszylinder								
0.9 TCe 75	56	08/18→08/21		für Linkslenker		24.4123-1723.3 011074		Ø 23,8 ohne Bremsflüssigkeitsbehälter
0.9 TCe 90	66	01/13→08/21						
1.2 16V	54	01/13→08/21						
1.2 TCe 120	87 - 88	03/13→08/21						
1.5 dCi 110	81	06/16→08/21						
1.5 dCi 75	55	01/13→08/21						
1.5 dCi 90	66	11/12→08/21						









	kw					! #		
RENAULT - CLIO IV Kasten/Kombi (KH_) 01/13→08/21								
 Hauptbremszylinder								
0.9 TCe 90 1.5 dCi 75 1.5 dCi 90	66 55 66	01/14→08/21 01/14→08/21 01/14→08/21		für Linkslenker			24.4123-1723.3 011074	Ø 23,8 ohne Bremsflüssigkeitsbehälter
RENAULT - CLIO IV Kasten/Schrägheck (BH_) 01/14→08/21								
 Hauptbremszylinder								
0.9 TCe 90 0.9 TCe 90 LPG 1.2 16V 1.2 16V LPG 1.5 dCi 75	66 66 54 - 55 53	01/14→08/21 08/15→08/21 01/14→08/21 01/14→08/21 01/14→08/21		für Linkslenker			24.4120-1771.3 011076	Ø 20,6 ohne Bremsflüssigkeitsbehälter
1.5 dCi 90	66	01/14→08/21		für Linkslenker; Schaltgetriebe			24.4120-1771.3 011076	Ø 20,6 ohne Bremsflüssigkeitsbehälter
				für Linkslenker; Schaltgetriebe			24.4120-1771.3 011076	Ø 20,6 ohne Bremsflüssigkeitsbehälter
				für Linkslenker; Automatikgetriebe			24.4123-1723.3 011074	Ø 23,8 ohne Bremsflüssigkeitsbehälter
				für Rechtslenker; Automatikgetriebe			24.4123-1724.3 011075	TRW Ø 23,8 ohne Bremsflüssigkeitsbehälter
RENAULT - DOKKER 12/13→								
 Hauptbremszylinder								
1.5 dCi 1.6	66 62	12/13→ 12/13→12/21		- ESP			24.4152-0381.3 011032	ATE Ø 22,2 ohne Bremsflüssigkeitsbehälter
				+ ESP			24.4152-0391.3 011033	ATE Ø 22,2 ohne Bremsflüssigkeitsbehälter
RENAULT - DUSTER (HS_) 01/11→								
 Bremskraftverstärker								
1.5 dCi 1.6 16V	63 76	02/12→ 02/12→		→ 10/13; + ABS			03.7853-4602.4 300302	ATE Ø 9" pneumatisch
1.5 dCi 4x4 1.6 16V 1.6 16V 4x4 2.0 2.0 4x4	66 75 - 84 75 - 84 98 - 105 99 - 105	06/11→ 02/12→ 06/11→ 10/11→ 01/11→		für Linkslenker; + ABS			03.7853-4602.4 300302	ATE Ø 9" pneumatisch
1.5 dCi 4x4	80	09/13→01/18		+ ABS			03.7853-4602.4 300302	ATE Ø 9" pneumatisch
 Hauptbremszylinder								
1.5 dCi 1.6 16V	63 76	02/12→ 02/12→		→ 10/13; - ESP			03.2122-2031.3 010938	ATE Ø 22,2
				→ 10/13; + ESP			03.2122-2261.3 010964	ATE Ø 22,2
				11/13→; + ABS / - ESP			24.4152-0381.3 011032	ATE Ø 22,2 ohne Bremsflüssigkeitsbehälter
				11/13→; + ABS / + ESP			24.4152-0391.3 011033	ATE Ø 22,2 ohne Bremsflüssigkeitsbehälter
1.5 dCi 4x4 1.6 16V 1.6 16V 4x4 2.0 2.0 4x4	66 75 - 84 75 - 84 98 - 105 99 - 105	06/11→ 02/12→ 06/11→ 10/11→ 01/11→		für Linkslenker; + ABS			03.2122-2031.3 010938	ATE Ø 22,2
				für Linkslenker; + ESP			03.2122-2261.3 010964	ATE Ø 22,2
1.5 dCi 4x4	80	09/13→01/18		+ ABS / - ESP			03.2122-2031.3 010938	ATE Ø 22,2
				+ ABS / + ESP			03.2122-2261.3 010964	ATE Ø 22,2
RENAULT - ESPACE III (JE0_) 11/96→10/02								
 Hauptbremszylinder								
1.9 dTi 2.0 2.0 16V	72 84 - 102 103	02/99→10/02 11/96→10/02 10/98→10/02		+ ABS			03.2123-1486.3 010488	Ø 23,8
2.2 12V TD 2.2 D 3.0 V6 24V	83 84 140	11/96→10/00 11/97→01/00 10/98→10/02		+ ABS			03.2123-1486.3 010488	Ø 23,8
				- ABS			03.2123-1741.3 010537	ATE Ø 23,8
2.2 dCi	95	10/00→10/02					03.2123-1486.3 010488	Ø 23,8
2.2 dCi	85	07/00→10/02					03.2123-1741.3 010537	ATE Ø 23,8









	kW			 	! #		
RENAULT - ESPACE IV (JK0/1_) 11/02→							
 Bremskraftverstärker							
1.9 dCi	85	11/02→		für Linkslenker		03.7868-1602.4 300220	ATE Ø 10 / 8" pneumatisch
2.0	88	11/02→					
2.0 dCi	98 - 125	11/02→					
2.0 Turbo	96 - 127	01/06→					
2.2 dCi	120	11/02→					
3.0 dCi	102 - 110	11/02→					
3.5 V6	120 - 133	11/02→					
	177	11/02→					
 Hauptbremszylinder							
1.9 dCi	85 - 88	11/02→		→ 12/04; + ESP		03.4125-0014.3 010794	ATE Ø 25,4
2.0	98 - 100	11/02→12/15		- ESP		03.4125-0021.3 010888	ATE Ø 25,4
2.0 Turbo	120	11/02→		01/05→; + ESP		03.4155-0043.3 010795	ATE Ø 25,4
2.2 dCi	110	11/02→08/06					
3.0 dCi	130	11/02→08/06					
3.5 V6	177	11/02→					
2.0	125	04/05→		- ESP		03.4125-0021.3 010888	ATE Ø 25,4
2.0 dCi	96 - 127	01/06→		+ ESP		03.4155-0043.3 010795	ATE Ø 25,4
2.2 dCi	102	02/06→					
3.0 dCi	120 - 133	09/05→					
RENAULT - GRAND SCÉNIC II (JM0/1_) 04/04→06/09							
 Hauptbremszylinder							
1.5 dCi	74 - 76	04/04→11/08				24.2123-1760.3 010779	TRW Ø 23,8
1.6	77 - 83	04/04→11/08				24.4123-1721.3 011052	BOS Ø 23,8 ohne Bremsflüssigkeitsbehälter
1.9 dCi	81 - 88	04/04→01/09					
2.0 dCi	110	09/05→11/08					
1.5 dCi	78	05/05→01/09		06/06→		24.2123-1760.3 010779	TRW Ø 23,8
						24.4123-1721.3 011052	BOS Ø 23,8 ohne Bremsflüssigkeitsbehälter
1.6 Flex	82	06/06→06/09				24.2123-1760.3 010779	TRW Ø 23,8
				→ 03/09		24.4123-1721.3 011052	BOS Ø 23,8 ohne Bremsflüssigkeitsbehälter
1.9 dCi	96	04/04→02/08				24.2123-1760.3 010779	TRW Ø 23,8
				05/05→		24.4123-1721.3 011052	BOS Ø 23,8 ohne Bremsflüssigkeitsbehälter
2.0	99 - 120	04/04→06/09		→ 03/09		24.2123-1760.3 010779	TRW Ø 23,8
						24.4123-1721.3 011052	BOS Ø 23,8 ohne Bremsflüssigkeitsbehälter
RENAULT - GRAND SCÉNIC III (JZ0/1_) 02/09→09/16							
 Hauptbremszylinder							
1.2 TCe	85 - 96	04/12→09/16				24.4123-1715.3 010980	TRW Ø 23,8
1.4 16V	96	02/09→09/16					
1.5 dCi	63 - 81	02/09→09/16					
1.6 16V	81	02/09→09/16					
1.6 16V Bifuel	79 - 81	02/09→09/16					
1.6 dCi	96	04/11→09/16					
1.6 E85	81	02/09→09/16					
1.9 dCi	96	02/09→09/16					
2.0 16V	103	02/09→09/16					
2.0 dCi	110 - 118	02/09→09/16					
1.2 TCe	97	01/13→09/16		03/13→		24.4123-1715.3 010980	TRW Ø 23,8
RENAULT - KADJAR (HA_, HL_) 06/15→							
 Hauptbremszylinder							
1.2 TCe 130	96	06/15→		für Linkslenker		24.4123-1728.3 011089	Ø 23,8 ohne Bremsflüssigkeitsbehälter
1.3 TCe 140	103	08/18→					
1.3 TCe 160	116 - 117	08/18→					
1.5 BLUE dCi 115	85	08/18→					
→							















	kw			 	! #		
RENAULT - KADJAR (HA_, HL_) 06/15→							
 Hauptbremszylinder							
1.5 dCi 110 1.6 dCi 130 1.6 dCi 130 4x4 1.6 TCe 165 1.7 Blue dCi 150 1.7 Blue dCi 150 4WD	81 96 96 120 110 110	06/15→ 06/15→ 06/15→ 11/16→ 08/18→ 08/18→		für Linkslenker		24.4123-1728.3 011089	Ø 23,8 ohne Bremsflüssigkeitsbehälter
RENAULT - KANGOO / GRAND KANGOO II (KW0/1_) 02/08→							
 Hauptbremszylinder							
1.2 TCe 115 1.5 dCi 1.5 dCi 105 1.5 dCi 110 1.5 dCi 70 1.5 dCi 75 1.5 dCi 85 1.5 dCi 90 1.6 1.6 16V 1.6 16V FLEX 1.6 16V LPG	84 78 76 80 - 81 50 55 63 66 64 78 78 78	07/13→ 02/08→ 02/08→ 09/10→ 02/08→ 11/12→ 02/08→ 06/08→ 02/08→ 02/08→ 02/08→ 02/08→		+ ABS; → 12/14		24.4122-1720.3 011065	ATE Ø 22,2 ohne Bremsflüssigkeitsbehälter
RENAULT - KANGOO (KC0/1_) 08/97→							
 Hauptbremszylinder							
1.0 1.0 RN 1.2 16V 1.5 dCi 1.6 16V 1.6 16V 4x4 1.6 16V bivalent 1.9 dCi 4x4 1.9 dTi 1.9 RXED D 65 1.9	50 43 55 45 - 60 70 70 60 59 - 62 59 48 47	01/02→01/07 01/02→01/07 06/01→ 12/01→ 06/01→ 10/01→ 06/05→ 10/01→ 02/00→ 09/99→06/01 08/97→06/01		für Linkslenker → 12/07; - ABS - ABS 03/98→; - ABS		24.2122-1727.3 010586 24.2122-1727.3 010586 24.2122-1727.3 010586 24.2122-1727.3 010586	BDX Ø 22,2 BDX Ø 22,2 BDX Ø 22,2 BDX Ø 22,2
RENAULT - KANGOO BE BOP (KW0/1_) 02/09→							
 Hauptbremszylinder							
1.5 dCi 1.5 dCi 75 1.6	66 - 80 55 78	02/09→ 09/10→ 02/09→12/12		→ 12/10; + ABS		24.4122-1720.3 011065	ATE Ø 22,2 ohne Bremsflüssigkeitsbehälter
RENAULT - KANGOO Express (FC0/1_) 08/97→							
 Hauptbremszylinder							
1.0 1.0 1.2 1.2 BiFuel 1.6 1.9 D 1.2 16V 1.5 dCi 1.6 16V 1.6 16V 4x4 1.6 16V bivalent 1.9 dCi 1.9 dCi 4x4 1.9 dTi 1.4	43 50 44 43 66 48 55 42 - 62 70 70 60 62 59 - 62 59 55	01/02→01/07 01/02→01/07 07/98→07/01 07/98→07/01 09/99→06/01 09/99→06/03 10/01→ 12/01→ 10/01→ 10/01→ 06/05→ 07/03→ 10/01→ 02/00→ 08/97→06/08		für Linkslenker 07/03→; - ABS - ABS → 12/07; - ABS 03/98→ 12/07; - ABS		24.2122-1727.3 010586 24.2122-1727.3 010586 24.2122-1727.3 010586 24.2122-1727.3 010586 24.2122-1727.3 010586	BDX Ø 22,2 BDX Ø 22,2 BDX Ø 22,2 BDX Ø 22,2 BDX Ø 22,2 BDX Ø 22,2 BDX Ø 22,2
RENAULT - KANGOO Express (FW0/1_) 02/08→							
 Hauptbremszylinder							
1.2 TCe 115 1.5 dCi 105 1.5 dCi 110 1.5 dCi 70 1.5 dCi 75 1.5 dCi 85 →	84 76 80 - 81 50 55 63	07/13→ 02/08→ 09/10→ 02/08→ 09/10→ 02/08→		+ ABS; → 12/14		24.4122-1720.3 011065	ATE Ø 22,2 ohne Bremsflüssigkeitsbehälter















	kw					! #		
RENAULT - KANGOO Express (FW0/1_) 02/08→								
 Hauptbremszylinder								
1.5 dCi 90 1.6	66 64 - 81	06/09→ 02/08→			+ ABS; → 12/14		24.4122-1720.3 011065	ATE Ø 22,2 ohne Bremsflüssigkeitsbehälter
1.6 16V 1.6 16V FLEX 1.6 16V LPG Z.E.	78 78 78 44	02/08→ 02/08→ 02/08→ 10/11→						
RENAULT - KAPTUR (H5_) 03/16→								
 Hauptbremszylinder								
1.6 2.0 4WD	84 105	03/16→ 03/16→					24.4152-0391.3 011033	ATE Ø 22,2 ohne Bremsflüssigkeitsbehälter
RENAULT - KOLEOS II (HC_) 04/16→								
 Hauptbremszylinder								
1.6 dCi 130 1.7 BLUE dCi 150 2.0 BLUE DCI 185 2.0 BLUE DCI 185 4WD 2.0 BLUE dCi 190 4WD 2.0 dCi 175 2.0 dCi 175 4WD 2.0 TCe 2.5 Sce 2.5 Sce 4WD	96 110 135 135 140 130 130 107 126 126	04/16→ 06/19→ 01/20→ 01/20→ 06/19→ 04/16→ 04/16→ 04/16→ 04/16→ 04/16→			für Linkslenker		24.4123-1728.3 011089	Ø 23,8 ohne Bremsflüssigkeitsbehälter
RENAULT - LAGUNA I (B56_, 556_) 11/93→08/02								
 Hauptbremszylinder								
1.6 16V 1.8 16V 1.9 dTi 3.0 24V	79 88 72 140	11/97→03/01 04/98→03/01 10/97→03/01 03/97→03/01			02/99→ 02/01 → 01/99		24.2123-1701.3 010424 24.2123-1725.3 010549	Ø 23,8 Ø 23,8
1.8	69	06/95→02/01			- ABS → 01/97; + ABS 02/97→; + ABS		03.2122-1001.3 010562 10.6123-0312.3 010457 24.2123-1725.3 010549	Ø 22,2 ATE Ø 23,8 Ø 23,8
1.8 2.2 D	66 - 69 61	11/93→03/01 11/93→03/01			→ 02/01; - ABS → 01/97; + ABS 02/97→ 02/01; + ABS		03.2122-1001.3 010562 10.6123-0312.3 010457 24.2123-1725.3 010549	Ø 22,2 ATE Ø 23,8 Ø 23,8
1.8	66	08/95→03/01			02/99→ 02/01; + ABS 02/97→ 02/01; + ABS		24.2123-1701.3 010424 24.2123-1725.3 010549	Ø 23,8 Ø 23,8
1.9 dCi 2.0 2.0 16V 2.0	79 80 103 84	09/99→03/01 03/99→03/01 09/99→03/01 06/95→02/01			→ 02/01 → 01/97; + ABS		24.2123-1701.3 010424 10.6123-0312.3 010457	Ø 23,8 ATE Ø 23,8
2.0	83	11/93→03/01			02/97→ 02/01; + ABS → 02/01; - ABS		24.2123-1725.3 010549 24.2123-1725.3 010549	Ø 23,8 Ø 23,8
2.0 16V	102	06/95→03/01			→ 02/01; + ABS 02/99→ 02/01; + ABS 02/97→ 01/99; + ABS → 02/01; - ABS		10.6123-0312.3 010457 24.2123-1701.3 010424 24.2123-1725.3 010549 24.2123-1725.3 010549	ATE Ø 23,8 Ø 23,8 Ø 23,8 Ø 23,8
2.2 dT	83	03/96→03/01			→ 01/97; + ABS 02/99→ 02/01; + ABS 02/97→ 01/99; + ABS → 02/01; - ABS		10.6123-0312.3 010457 24.2123-1701.3 010424 24.2123-1725.3 010549 24.2123-1725.3 010549	ATE Ø 23,8 Ø 23,8 Ø 23,8 Ø 23,8
3.0	123	11/93→03/01			→ 01/97; + ABS 02/97→ 02/01		10.6123-0312.3 010457 24.2123-1725.3 010549	ATE Ø 23,8 Ø 23,8
RENAULT - LAGUNA I Grandtour (K56_) 09/95→08/02								
 Hauptbremszylinder								
1.6 16V 1.8 16V 1.9 dTi 3.0 24V	79 88 72 140	11/97→03/01 04/98→03/01 10/97→03/01 03/97→03/01			02/99→ 02/01 → 01/99		24.2123-1701.3 010424 24.2123-1725.3 010549	Ø 23,8 Ø 23,8
1.8	66	09/95→03/01			→ 01/97; + ABS 02/99→ 02/01; + ABS 02/97→ 02/01; + ABS 02/97→ 01/99; + ABS → 02/01; - ABS		10.6123-0312.3 010457 24.2123-1701.3 010424 24.2123-1725.3 010549 24.2123-1725.3 010549 24.2123-1725.3 010549	ATE Ø 23,8 Ø 23,8 Ø 23,8 Ø 23,8 Ø 23,8
→								













	kw			 	! #		
RENAULT - LAGUNA I Grandtour (K56_) 09/95→08/02							
 Hauptbremszylinder							
1.8 2.2 D	69 61	09/95→03/01 09/95→03/01		→ 01/97; + ABS 02/97→ 02/01; + ABS → 02/01; - ABS		10.6123-0312.3 010457 24.2123-1725.3 010549 24.2123-1725.3 010549	ATE Ø 23,8 Ø 23,8 Ø 23,8
1.9 dCi	79	09/99→03/01		→ 02/01		24.2123-1701.3 010424	Ø 23,8
2.0	84	10/98→01/01		+ ABS - ABS		10.6123-0312.3 010457 24.2123-1725.3 010549	ATE Ø 23,8 Ø 23,8
2.0	83	09/95→03/01		→ 01/97; + ABS 11/95→ 01/97; + ABS → 02/01; + ABS 02/99→ 02/01; + ABS 11/95→ 02/01; - ABS 02/97→ 02/01; + ABS 02/97→ 01/99; + ABS → 02/01 → 02/01; - ABS		10.6123-0312.3 010457 10.6123-0312.3 010457 10.6123-0312.3 010457 24.2123-1701.3 010424 24.2123-1725.3 010549 24.2123-1725.3 010549 24.2123-1725.3 010549 24.2123-1725.3 010549 24.2123-1725.3 010549	ATE Ø 23,8 ATE Ø 23,8 ATE Ø 23,8 Ø 23,8 Ø 23,8 Ø 23,8 Ø 23,8 Ø 23,8
2.0 16V	102	09/95→03/01		→ 01/97; + ABS → 02/01; + ABS 02/99→ 02/01; + ABS 09/99→ 02/01 02/97→ 01/99 → 02/01; - ABS		10.6123-0312.3 010457 10.6123-0312.3 010457 24.2123-1701.3 010424 24.2123-1701.3 010424 24.2123-1725.3 010549 24.2123-1725.3 010549	ATE Ø 23,8 ATE Ø 23,8 Ø 23,8 Ø 23,8 Ø 23,8 Ø 23,8
2.2 dT	83	03/96→03/01		→ 01/97; + ABS 02/99→ 02/01; + ABS 02/97→ 01/99; + ABS → 02/01; - ABS		10.6123-0312.3 010457 24.2123-1701.3 010424 24.2123-1725.3 010549 24.2123-1725.3 010549	ATE Ø 23,8 Ø 23,8 Ø 23,8 Ø 23,8
3.0	123	02/96→03/01		03/96→ 01/97; + ABS → 02/01; + ABS 02/97→ 02/01		10.6123-0312.3 010457 10.6123-0312.3 010457 24.2123-1725.3 010549	ATE Ø 23,8 ATE Ø 23,8 Ø 23,8
RENAULT - LAGUNA II (BG0/1_) 03/01→12/07							
 Bremskraftverstärker							
1.6 1.6 16V 1.6 LPG 1.8 16V	76 79 79 86 - 89	03/01→05/05 03/01→05/05 03/01→05/05 03/01→05/05		06/01→; für Linkslenker		03.7873-1202.4 300197	ATE Ø 11" pneumatisch
1.6 16V 1.9 dCi 2.0 16V 2.0 dCi 2.2 dCi	82 79 - 96 99 - 150 127 102	02/05→08/07 03/01→12/07 08/02→12/07 01/06→08/07 05/05→08/07		→ 06/07; für Linkslenker		03.7873-1202.4 300197	ATE Ø 11" pneumatisch
1.8 16V 1.9 dCi 2.0 16V IDE 3.0 V6 24V	85 - 88 88 103 152	03/01→12/07 03/01→09/07 04/01→09/07 03/01→08/07		06/01→ 06/07; für Linkslenker		03.7873-1202.4 300197	ATE Ø 11" pneumatisch
1.9 dCi 1.9 dCi 2.0 16V 2.0 16V Turbo 2.0 dCi 2.2 dCi	68 - 74 77 98 120 110 85 - 110	10/01→05/05 06/01→05/05 08/02→12/06 01/03→03/05 08/05→08/06 10/01→08/06		für Linkslenker		03.7873-1202.4 300197	ATE Ø 11" pneumatisch
Pedalwegsensoren, Bremspedal							
1.6 1.6 16V 1.6 LPG 1.8 16V	76 79 79 86 - 89	03/01→05/05 03/01→05/05 03/01→05/05 03/01→05/05		→ 05/01; für Linkslenker für Rechtslenker		03.0655-0007.2 370007 03.0655-0007.2 370007	ATE ATE
1.6 16V 1.9 dCi 2.0 16V 2.0 dCi 2.2 dCi	82 79 - 96 99 - 150 127 102	02/05→08/07 03/01→12/07 08/02→12/07 01/06→08/07 05/05→08/07		→ 06/07; für Rechtslenker		03.0655-0007.2 370007	ATE
→							

	kW			 	! #		
RENAULT - LAGUNA II (BG0/1_) 03/01→12/07							
Pedalwegsensord, Bremspedal							
1.8 16V	85 - 88	03/01→12/07		→ 05/01; für Linkslenker		03.0655-0007.2 370007	ATE
1.9 dCi	88	03/01→09/07		→ 06/07; für Rechtslenker		03.0655-0007.2 370007	ATE
2.0 16V IDE	103	04/01→09/07					
3.0 V6 24V	152	03/01→08/07					
1.9 dCi	68 - 74	10/01→05/05		für Rechtslenker		03.0655-0007.2 370007	ATE
1.9 dCi	77	06/01→05/05					
2.0 16V	98	08/02→12/06					
2.0 16V Turbo	120	01/03→03/05					
2.0 dCi	110	08/05→08/06					
2.2 dCi	85 - 110	10/01→08/06					
2.9 V6 24V	155	03/01→08/07				03.0655-0007.2 370007	ATE
 Hauptbremszylinder							
1.6	76	03/01→05/05		→ 03/05		03.4123-0081.3 010585	ATE Ø 23,8
1.6 16V	79	03/01→05/05					
1.6 LPG	79	03/01→05/05		04/05→		03.4153-0063.3 010773	ATE Ø 23,8
1.8 16V	86 - 89	03/01→05/05					
1.9 dCi	68 - 74	10/01→05/05					
1.9 dCi	77	06/01→05/05					
2.0 16V	98	08/02→12/06					
2.2 dCi	85 - 110	10/01→08/06					
1.6 16V	82	02/05→08/07		→ 06/07		03.4153-0063.3 010773	ATE Ø 23,8
1.9 dCi	85 - 96	05/05→12/07					
2.0 dCi	127	01/06→08/07					
2.2 dCi	102	05/05→08/07					
1.8 16V	85 - 88	03/01→12/07		→ 03/05		03.4123-0081.3 010585	ATE Ø 23,8
1.9 dCi	79 - 88	03/01→09/07		04/05→ 06/07		03.4153-0063.3 010773	ATE Ø 23,8
2.0 16V	99 - 150	08/02→12/07					
2.0 16V IDE	103	04/01→09/07					
3.0 V6 24V	152	03/01→08/07					
2.0 16V Turbo	120	01/03→03/05				03.4153-0063.3 010773	ATE Ø 23,8
2.0 dCi	110	08/05→08/06					
2.9 V6 24V	155	03/01→08/07				03.4123-0081.3 010585	ATE Ø 23,8
Verschlusschraube, Hauptbremszylinder							
1.6	76	03/01→05/05		→ 03/05; - ESP		03.3517-0300.1 390323	
1.6 16V	79	03/01→05/05					
1.6 LPG	79	03/01→05/05					
1.8 16V	85 - 89	03/01→12/07					
1.9 dCi	68 - 88	03/01→09/07					
1.9 dCi	77	06/01→05/05					
2.0 16V	98 - 150	08/02→12/07					
2.0 16V IDE	103	04/01→09/07					
2.2 dCi	85 - 110	10/01→08/06					
3.0 V6 24V	152	03/01→08/07					
2.9 V6 24V	155	03/01→08/07		- ESP		03.3517-0300.1 390323	
RENAULT - LAGUNA II Grandtour (KG0/1_) 03/01→12/07							
 Bremskraftverstärker							
1.6	76	03/01→10/05		06/01→; für Linkslenker		03.7873-1202.4 300197	ATE Ø 11" pneumatisch
1.8 16V	85 - 89	03/01→05/05					
3.0 V6 24V	152	03/01→12/07					
1.6 16V	82	02/05→08/07		→ 06/07; für Linkslenker		03.7873-1202.4 300197	ATE Ø 11" pneumatisch
1.6 Bifuel	79	06/05→12/07					
1.9 dCi	79 - 96	03/01→12/07					
2.0 16V	98 - 150	08/02→12/07					
2.0 dCi	127	01/06→12/07					
2.2 dCi	102	05/05→12/07					
1.6 16V	79	03/01→12/07		06/01→ 06/07; für Linkslenker		03.7873-1202.4 300197	ATE Ø 11" pneumatisch
1.9 dCi	88	03/01→09/07					
2.0 16V IDE	103	04/01→09/07					
1.9 dCi	66	08/03→09/07		03/04→ 06/07; für Linkslenker		03.7873-1202.4 300197	ATE Ø 11" pneumatisch
→							

	kW			 	! #		
RENAULT - LAGUNA II Grandtour (KG0/1_) 03/01→12/07							
 Bremskraftverstärker							
1.9 dCi	68 - 74	10/01→05/05		für Linkslenker		03.7873-1202.4 300197	ATE Ø 11" pneumatisch
1.9 dCi	77	06/01→05/05					
2.0 16V Turbo	120	01/03→08/05					
2.0 dCi	110	08/05→08/06					
2.2 dCi	85 - 110	10/01→08/06					
2.9 V6 24V	155	10/03→12/07					
Pedalwegsensord, Bremspedal							
1.6	76	03/01→10/05		→ 05/01; für Linkslenker		03.0655-0007.2 370007	ATE
1.8 16V	85 - 89	03/01→05/05		für Rechtslenker		03.0655-0007.2 370007	ATE
3.0 V6 24V	152	03/01→12/07					
1.6 16V	82	02/05→08/07		→ 06/07; für Rechtslenker		03.0655-0007.2 370007	ATE
1.6 Bifuel	79	06/05→12/07					
1.9 dCi	79 - 96	03/01→12/07					
2.0 16V	98 - 150	08/02→12/07					
2.0 dCi	127	01/06→12/07					
2.2 dCi	102	05/05→12/07					
1.6 16V	79	03/01→12/07		→ 05/01; für Linkslenker		03.0655-0007.2 370007	ATE
2.0 16V IDE	103	04/01→09/07		→ 06/07; für Rechtslenker		03.0655-0007.2 370007	ATE
1.9 dCi	66	08/03→09/07		03/04→ 06/07; für Rechtslenker		03.0655-0007.2 370007	ATE
1.9 dCi	68 - 74	10/01→05/05		für Rechtslenker		03.0655-0007.2 370007	ATE
1.9 dCi	77	06/01→05/05					
2.0 16V Turbo	120	01/03→08/05					
2.0 dCi	110	08/05→08/06					
2.2 dCi	85 - 110	10/01→08/06					
2.9 V6 24V	155	10/03→12/07					
1.9 dCi	88	03/01→09/07		→ 05/01; für Linkslenker		03.0655-0007.2 370007	ATE
				06/01→ 06/07; für Rechtslenker		03.0655-0007.2 370007	ATE
 Hauptbremszylinder							
1.6	76	03/01→10/05		→ 03/05		03.4123-0081.3 010585	ATE Ø 23,8
1.8 16V	85 - 89	03/01→05/05		04/05→		03.4153-0063.3 010773	ATE Ø 23,8
1.9 dCi	68 - 74	10/01→05/05					
1.9 dCi	77	06/01→05/05					
2.2 dCi	85 - 110	10/01→08/06					
2.9 V6 24V	155	10/03→12/07					
3.0 V6 24V	152	03/01→12/07					
1.6 16V	79 - 82	03/01→12/07		→ 03/05		03.4123-0081.3 010585	ATE Ø 23,8
1.9 dCi	79 - 88	03/01→12/07		04/05→ 06/07		03.4153-0063.3 010773	ATE Ø 23,8
2.0 16V	98 - 99	08/02→12/07					
2.0 16V IDE	103	04/01→09/07					
1.6 Bifuel	79	06/05→12/07		→ 06/07		03.4153-0063.3 010773	ATE Ø 23,8
1.9 dCi	85 - 96	05/05→12/07					
2.0 16V	125 - 150	01/05→09/07					
2.0 dCi	127	01/06→12/07					
2.2 dCi	102	05/05→12/07					
1.9 dCi	66	08/03→09/07		03/04→ 03/05		03.4123-0081.3 010585	ATE Ø 23,8
				04/05→ 06/07		03.4153-0063.3 010773	ATE Ø 23,8
1.9 dCi	81	01/05→12/07		→ 03/05		03.4123-0081.3 010585	ATE Ø 23,8
				→ 06/07		03.4153-0063.3 010773	ATE Ø 23,8
2.0 16V Turbo	120	01/03→08/05				03.4153-0063.3 010773	ATE Ø 23,8
2.0 dCi	110	08/05→08/06					
Verschlusschraube, Hauptbremszylinder							
1.6	76	03/01→10/05		→ 03/05; - ESP		03.3517-0300.1 390323	
1.6 16V	79 - 82	03/01→12/07					
1.8 16V	85 - 89	03/01→05/05					
1.9 dCi	68 - 88	03/01→12/07					
1.9 dCi	77	06/01→05/05					
→							

	kw			 	! #		
RENAULT - LAGUNA II Grandtour (KG0/1_) 03/01→12/07							
Verschlusschraube, Hauptbremszylinder							
2.0 16V	98 - 99	08/02→12/07		→ 03/05; - ESP		03.3517-0300.1 390323	
2.0 16V IDE	103	04/01→09/07					
2.2 dCi	85 - 110	10/01→08/06					
2.9 V6 24V	155	10/03→12/07					
3.0 V6 24V	152	03/01→12/07					
1.9 dCi	66	08/03→09/07		03/04→ 03/05; - ESP		03.3517-0300.1 390323	
RENAULT - LODGY (JS_) 07/13→							
 Hauptbremszylinder							
1.5 dCi	62	01/15→		- ESP		24.4152-0381.3 011032	ATE Ø 22,2 ohne Bremsflüssigkeitsbehälter
1.6	59	07/13→		+ ESP		24.4152-0391.3 011033	ATE Ø 22,2 ohne Bremsflüssigkeitsbehälter
RENAULT - LOGAN/STEPWAY II (L8_) 09/12→							
 Hauptbremszylinder							
1.2	55	11/13→		für Linkslenker; - ABS		24.4120-1714.3 011110	Ø 20,6 ohne Bremsflüssigkeitsbehälter
1.2 16V LPG	53	11/13→					
1.5 dCi	62 - 66	12/13→		für Linkslenker; + ABS		24.4120-1771.3 011076	Ø 20,6 ohne Bremsflüssigkeitsbehälter
1.6	59 - 83	11/13→					
RENAULT - LOGAN I (LS_) 09/04→							
 Bremskraftverstärker							
1.4	55	09/04→		→ 10/09; + ABS		03.7750-8532.4 300264	ATE Ø 9" pneumatisch
1.4 LPG	53	02/08→10/13		11/09→; + ABS		03.7853-4602.4 300302	ATE Ø 9" pneumatisch
1.5 dCi	48	04/06→10/13		→ 04/13; + ABS		03.7853-4602.4 300302	ATE Ø 9" pneumatisch
1.5 dCi	50 - 63	04/07→		→ 10/09; + ABS		03.7750-8532.4 300264	ATE Ø 9" pneumatisch
1.6	64 - 77	09/04→		11/09→ 04/13; + ABS		03.7853-4602.4 300302	ATE Ø 9" pneumatisch
 Hauptbremszylinder							
1.4	55	09/04→		+ ABS		24.2120-1754.3 010949	Ø 20,6
1.4 LPG	53	02/08→10/13		- ABS		24.2120-1762.3 011002	Ø 20,6 ohne Bremsflüssigkeitsbehälter
1.5 dCi	48 - 63	04/06→		→ 04/13; + ABS		24.2120-1754.3 010949	Ø 20,6
1.6	64 - 77	09/04→		- ABS; → 04/13		24.2120-1762.3 011002	Ø 20,6 ohne Bremsflüssigkeitsbehälter
RENAULT - LOGAN I Kombi (KS_) 04/07→							
 Bremskraftverstärker							
1.4	55	10/07→		→ 10/09; + ABS		03.7750-8532.4 300264	ATE Ø 9" pneumatisch
1.5 dCi	50 - 63	04/07→		11/09→ 04/13; + ABS		03.7853-4602.4 300302	ATE Ø 9" pneumatisch
1.6	64 - 77	04/07→					
1.5 dCi	66	06/11→06/15		→ 04/13; + ABS		03.7853-4602.4 300302	ATE Ø 9" pneumatisch
 Hauptbremszylinder							
1.4	55	10/07→		+ ABS; → 04/13		24.2120-1754.3 010949	Ø 20,6
1.5 dCi	50 - 66	04/07→		- ABS; → 04/13		24.2120-1762.3 011002	Ø 20,6 ohne Bremsflüssigkeitsbehälter
1.6	64 - 77	04/07→					
RENAULT - LOGAN II Kombi (K8_) 11/13→							
 Hauptbremszylinder							
1.2 16V	54	12/13→		für Linkslenker; - ABS		24.4120-1714.3 011110	Ø 20,6 ohne Bremsflüssigkeitsbehälter
1.2 16V LPG	53	12/13→					
1.5 dCi	62 - 66	12/13→		für Linkslenker; + ABS		24.4120-1771.3 011076	Ø 20,6 ohne Bremsflüssigkeitsbehälter
1.6	59 - 78	12/13→					
RENAULT - LOGAN EXPRESS (US_) 04/07→							
 Bremskraftverstärker							
1.5 dCi	50	04/07→		→ 04/13; + ABS		03.7750-8532.4 300264	ATE Ø 9" pneumatisch

	kw					! #		
RENAULT - LOGAN EXPRESS (US_) 04/07→								
 Bremskraftverstärker								
1.6	64	04/07→			→ 04/13; + ABS		03.7750-8532.4 300264	ATE Ø 9" pneumatisch
 Hauptbremszylinder								
1.5 dCi	50	04/07→			09/07→ 04/13; + ABS		03.2122-2031.3 010938	ATE Ø 22,2
1.6	64	04/07→						
RENAULT - MASTER II Bus (JD) 12/97→01/10								
 Hauptbremszylinder								
1.9 dCi 80	60	11/01→10/06			→ 10/03; + ABS		24.2025-1706.3 010676	Ø 25,4
2.2 dCi 90	66	12/97→09/06			11/03→ 08/06; - ABS		24.2025-1708.3 010692	Ø 25,4
2.5 dCi 120	84	10/01→12/06			→ 10/03; - ABS		24.2025-1708.3 010692	Ø 25,4
					11/03→ 08/06; + ABS		24.2123-1759.3 010768	BOS Ø 23,8
1.9 dTI	59	12/97→03/02			+ ABS		24.2025-1706.3 010676	Ø 25,4
2.5 D	59	07/98→01/01			- ABS		24.2025-1708.3 010692	Ø 25,4
2.8 dTI	84	07/98→10/01						
2.5 dCi	74 - 107	06/06→01/10			- ABS		24.2025-1708.3 010692	Ø 25,4
2.5 dCi 100	73	10/03→01/10						
3.0 dCi 140	100	10/03→09/06			→ 08/06; - ABS		24.2025-1708.3 010692	Ø 25,4
					→ 08/06; + ABS		24.2123-1759.3 010768	BOS Ø 23,8
RENAULT - MASTER II Kasten (FD) 12/97→12/13								
 Hauptbremszylinder								
1.9 dCi 80	60	11/01→10/06			→ 10/03; + ABS		24.2025-1706.3 010676	Ø 25,4
2.2 dCi 90	66	12/97→10/06			11/03→ 08/06; - ABS		24.2025-1708.3 010692	Ø 25,4
2.5 dCi 120	84	10/01→09/07			→ 10/03; - ABS		24.2025-1708.3 010692	Ø 25,4
					11/03→ 08/06; + ABS		24.2123-1759.3 010768	BOS Ø 23,8
1.9 dTI	59	12/97→03/02			+ ABS		24.2025-1706.3 010676	Ø 25,4
2.5 D	59	07/98→01/01			- ABS		24.2025-1708.3 010692	Ø 25,4
2.8 D	63	01/02→09/04						
2.8 dTI	84	07/98→10/01						
2.5 dCi	74 - 107	08/06→01/10			- ABS		24.2025-1708.3 010692	Ø 25,4
2.5 dCi 100	73	10/03→03/10			→ 08/06; - ABS		24.2025-1708.3 010692	Ø 25,4
3.0 dCi 140	100	10/03→10/06			→ 08/06; + ABS		24.2123-1759.3 010768	BOS Ø 23,8
RENAULT - MASTER II Pritsche/Fahrgestell (ED/HD/UD) 12/97→03/13								
 Hauptbremszylinder								
2.2 dCi 90	66	12/97→09/06			→ 10/03; + ABS		24.2025-1706.3 010676	Ø 25,4
2.5 dCi 120	84	10/01→05/10			11/03→ 08/06; - ABS		24.2025-1708.3 010692	Ø 25,4
					→ 10/03; - ABS		24.2025-1708.3 010692	Ø 25,4
					11/03→ 08/06; + ABS		24.2123-1759.3 010768	BOS Ø 23,8
2.5 D	59	07/98→01/01			+ ABS		24.2025-1706.3 010676	Ø 25,4
2.8 dTI	84	07/98→10/01			- ABS		24.2025-1708.3 010692	Ø 25,4
2.5 dCi	88	08/06→01/11			- ABS; → 12/10		24.2025-1708.3 010692	Ø 25,4
2.5 dCi	74 - 107	08/06→01/10			- ABS		24.2025-1708.3 010692	Ø 25,4
2.5 dCi 100	73	10/02→05/10			→ 08/06; - ABS		24.2025-1708.3 010692	Ø 25,4
3.0 dCi 140	100	10/03→01/10			→ 08/06; + ABS		24.2123-1759.3 010768	BOS Ø 23,8
RENAULT - MASTER III Bus (JV) 02/11→								
 Bremskraftverstärker								
2.3 dCi 100 FWD	74	02/11→					03.7868-5202.4 300309	ATE Ø 10 / 8" pneumatisch
2.3 dCi 110 FWD	81	09/14→						
2.3 dCi 125 FWD	92	02/11→						
2.3 dCi 135 FWD	100	07/14→						
2.3 dCi 145 FWD	107	02/11→						
2.3 dCi 165 FWD	120	07/14→						
2.3 dCi 170 FWD	125	07/15→						
2.3 dCi 180 FWD	132	01/20→						
2.3 dCi 150 FWD	110	10/12→			01/13→		03.7868-5202.4 300309	ATE Ø 10 / 8" pneumatisch
 Hauptbremszylinder								
2.3 dCi 100 FWD	74	02/11→					03.2126-3121.3 010967	ATE Ø 27
2.3 dCi 110 FWD	81	09/14→						
2.3 dCi 125 FWD	92	02/11→						
2.3 dCi 135 FWD	100	07/14→						
2.3 dCi 145 FWD	107	02/11→						
→								

	kw			 	! #		
RENAULT - MASTER III Bus (JV) 02/11→							
 Hauptbremszylinder							
2.3 dCi 165 FWD	120	07/14→				03.2126-3121.3 010967	ATE Ø 27
2.3 dCi 170 FWD	125	07/15→					
2.3 dCi 180 FWD	132	01/20→					
2.3 dCi 150 FWD	110	10/12→		01/13→		03.2126-3121.3 010967	ATE Ø 27
RENAULT - MASTER III Kasten (FV) 02/10→							
 Bremskraftverstärker							
2.3 dCi 100 FWD	74	02/10→				03.7868-5202.4 300309	ATE Ø 10 / 8" pneumatisch
2.3 dCi 100 RWD	74	02/10→					
2.3 dCi 110 FWD	81	09/14→					
2.3 dCi 125 FWD	92	02/10→					
2.3 dCi 125 RWD	92	02/10→					
2.3 dCi 130 FWD	96	06/16→					
2.3 dCi 130 RWD	96	03/12→					
2.3 dCi 135 FWD	100	07/14→					
2.3 dCi 135 RWD	100	07/14→					
2.3 dCi 145 4x4	107	05/16→09/21					
2.3 dCi 145 FWD	107	02/10→					
2.3 dCi 145 RWD	107	02/10→					
2.3 dCi 150 FWD	110	03/13→					
2.3 dCi 150 RWD	110	03/13→					
2.3 dCi 165 4x4	120	05/16→09/21					
2.3 dCi 165 FWD	120	07/14→					
2.3 dCi 165 RWD	120	07/14→					
2.3 dCi 170 FWD	125	07/15→					
2.3 dCi 180 FWD	132	07/19→					
Z.E.	57	03/18→					
 Hauptbremszylinder							
2.3 dCi 100 FWD	74	02/10→				03.2126-3121.3 010967	ATE Ø 27
2.3 dCi 100 RWD	74	02/10→					
2.3 dCi 110 FWD	81	09/14→					
2.3 dCi 125 FWD	92	02/10→					
2.3 dCi 125 RWD	92	02/10→					
2.3 dCi 130 FWD	96	06/16→					
2.3 dCi 130 RWD	96	03/12→					
2.3 dCi 135 FWD	100	07/14→					
2.3 dCi 135 RWD	100	07/14→					
2.3 dCi 145 4x4	107	05/16→09/21					
2.3 dCi 145 FWD	107	02/10→					
2.3 dCi 145 RWD	107	02/10→					
2.3 dCi 150 FWD	110	03/13→					
2.3 dCi 150 RWD	110	03/13→					
2.3 dCi 165 4x4	120	05/16→09/21					
2.3 dCi 165 FWD	120	07/14→					
2.3 dCi 165 RWD	120	07/14→					
2.3 dCi 170 FWD	125	07/15→					
2.3 dCi 180 FWD	132	07/19→					
Z.E.	57	03/18→					
RENAULT - MASTER III Pritsche/Fahrgestell (EV, HV, UV) 02/10→							
 Bremskraftverstärker							
2.3 dCi 100 FWD	74	02/10→				03.7868-5202.4 300309	ATE Ø 10 / 8" pneumatisch
2.3 dCi 100 RWD	74	02/10→					
2.3 dCi 110 FWD	81	09/14→					
2.3 dCi 125 FWD	92	02/10→					
2.3 dCi 125 RWD	92	02/10→					
2.3 dCi 130 FWD	96	03/12→					
2.3 dCi 130 RWD	96	07/16→					
2.3 dCi 135 FWD	100	07/14→					
2.3 dCi 135 RWD	100	07/14→					
2.3 dCi 145 4x4	107	07/14→06/19					
2.3 dCi 145 FWD	107	02/10→					
2.3 dCi 145 RWD	107	02/10→					
2.3 dCi 150 FWD	110	03/13→					
2.3 dCi 150 RWD	110	03/13→					
2.3 dCi 165 4x4	120	07/14→06/19					
2.3 dCi 165 FWD	120	07/14→					
2.3 dCi 165 RWD	120	07/14→					
2.3 dCi 170 FWD	125	06/16→					
2.3 dCi 180 FWD	132	07/19→					
Z.E.	57	03/18→					
 Hauptbremszylinder							
2.3 dCi 100 FWD	74	02/10→				03.2126-3121.3 010967	ATE Ø 27
2.3 dCi 100 RWD	74	02/10→					
2.3 dCi 110 FWD	81	09/14→					
2.3 dCi 125 FWD	92	02/10→					
2.3 dCi 125 RWD	92	02/10→					
2.3 dCi 130 FWD	96	03/12→					
→							

RENAULT - MASTER III Pritsche/Fahrgestell (EV, HV, UV) 02/10→

Hauptbremszylinder

2.3 dCi 130 RWD	96	07/16→			03.2126-3121.3	010967	ATE Ø 27
2.3 dCi 135 FWD	100	07/14→					
2.3 dCi 135 RWD	100	07/14→					
2.3 dCi 145 4x4	107	07/14→06/19					
2.3 dCi 145 FWD	107	02/10→					
2.3 dCi 145 RWD	107	02/10→					
2.3 dCi 150 FWD	110	03/13→					
2.3 dCi 150 RWD	110	03/13→					
2.3 dCi 165 4x4	120	07/14→06/19					
2.3 dCi 165 FWD	120	07/14→					
2.3 dCi 165 RWD	120	07/14→					
2.3 dCi 170 FWD	125	06/16→					
2.3 dCi 180 FWD	132	07/19→					
Z.E.	57	03/18→					

RENAULT - MEGANE I (BA0/1_) 08/95→12/04

Bremskraftverstärker

1.4 16V	70	03/99→08/03		→ 12/02; + ABS; für Linkslenker	03.7760-5502.4	300151	ATE Ø 10" pneumatisch
				→ 12/02; - ABS	03.7863-2002.4	300126	ATE Ø 10" pneumatisch
1.4 e	55	01/96→08/03		03/99→ 12/02; + ABS; für Linkslenker	03.7760-5502.4	300151	ATE Ø 10" pneumatisch
				03/99→ 12/02; - ABS	03.7760-5602.4	300121	ATE Ø 10" pneumatisch
1.6 16V	81	11/01→12/08		→ 12/02; + ABS; für Linkslenker; für Fahrzeuge ohne verstärktes Fahrwerk	03.7760-5102.4	300140	ATE Ø 10" pneumatisch
				→ 12/02; + ABS; für Linkslenker	03.7760-5502.4	300151	ATE Ø 10" pneumatisch
					03.7863-2002.4	300126	ATE Ø 10" pneumatisch
				→ 12/02; + ABS; für Linkslenker; für Fahrzeuge mit verstärktem Fahrwerk	03.7760-5502.4	300151	ATE Ø 10" pneumatisch
				→ 12/02; - ABS; für Fahrzeuge mit verstärktem Fahrwerk	03.7760-5602.4	300121	ATE Ø 10" pneumatisch
1.6 16V 1.6 LPG	79 80	03/99→08/02 10/00→08/02		+ ABS; für Linkslenker; für Fahrzeuge ohne verstärktes Fahrwerk	03.7760-5102.4	300140	ATE Ø 10" pneumatisch
				+ ABS; für Linkslenker	03.7760-5502.4	300151	ATE Ø 10" pneumatisch
					03.7863-2002.4	300126	ATE Ø 10" pneumatisch
				+ ABS; für Linkslenker; für Fahrzeuge mit verstärktem Fahrwerk	03.7760-5502.4	300151	ATE Ø 10" pneumatisch
				- ABS	03.7760-5602.4	300121	ATE Ø 10" pneumatisch
1.8 16V	85	01/01→08/03		→ 12/02; für Linkslenker	03.7863-2002.4	300126	ATE Ø 10" pneumatisch
1.9 dCi	75	02/01→08/03		→ 12/02; + ABS; für Linkslenker	03.7760-5102.4	300140	ATE Ø 10" pneumatisch
					03.7863-2002.4	300126	ATE Ø 10" pneumatisch
1.9 D Eco	47	01/96→08/03		06/98→ 12/02; + ABS; für Linkslenker	03.7760-5502.4	300151	ATE Ø 10" pneumatisch
				06/98→ 12/02; - ABS	03.7760-5602.4	300121	ATE Ø 10" pneumatisch
1.9 dTi	72	03/97→02/01		03/99→; für Linkslenker	03.7760-5102.4	300140	ATE Ø 10" pneumatisch
1.9 dTi	59	02/01→08/03		→ 12/02; + ABS; für Linkslenker	03.7863-2002.4	300126	ATE Ø 10" pneumatisch

Hauptbremszylinder

1.4 16V	70	03/99→08/03		→ 12/02; - ABS	03.2122-1541.3	010511	Ø 22,2
1.4 e	55	01/96→08/03		→ 12/02; - ABS	03.2120-2031.3	010106	ATE Ø 20,6
				06/98→ 02/99; - ABS	03.2120-2031.3	010106	ATE Ø 20,6
				03/99→ 12/02; - ABS	03.2122-1541.3	010511	Ø 22,2
				→ 12/02; + ABS; für Linkslenker	24.2120-1723.3	010545	BDX Ø 20,6
				→ 12/02; + ABS; für Rechtslenker	24.2120-1725.3	010579	BDX Ø 20,6
1.6 16V	81	11/01→12/08		→ 12/02; - ABS	03.2122-1541.3	010511	Ø 22,2
				→ 12/02; - ABS; für Fahrzeuge mit verstärktem Fahrwerk	03.2122-1541.3	010511	Ø 22,2
				→ 12/02; + ABS; für Linkslenker; für Fahrzeuge ohne verstärktes Fahrwerk	03.2123-2146.3	010572	Ø 23,8
1.6 16V 1.6 LPG	79 80	03/99→08/02 10/00→08/02		→ 12/02; + ABS; für Linkslenker	03.2123-2146.3	010572	Ø 23,8
				- ABS	03.2122-1541.3	010511	Ø 22,2
				- ABS; für Fahrzeuge mit verstärktem Fahrwerk	03.2122-1541.3	010511	Ø 22,2
				+ ABS; für Linkslenker; für Fahrzeuge ohne verstärktes Fahrwerk	03.2123-2146.3	010572	Ø 23,8
				+ ABS; für Linkslenker	03.2123-2146.3	010572	Ø 23,8

→

RENAULT - MEGANE I (BA0/1_) 08/95→12/04

Hauptbremszylinder

1.8 16V	85	01/01→08/03		→ 12/02; für Linkslenker	03.2123-2146.3 010572	Ø 23,8
1.9 D	69	04/96→02/01		09/96→; - ABS	03.2120-2031.3 010106	ATE Ø 20,6
				09/96→; + ABS	24.2120-1723.3 010545	BDX Ø 20,6
1.9 DCi	77	03/99→08/03		→ 12/02; + ABS; für Linkslenker	03.2123-2146.3 010572	Ø 23,8
1.9 dTi	59	02/01→08/03				
1.9 dCi	75	02/01→08/03		→ 12/02; - ABS	03.2122-1541.3 010511	Ø 22,2
				→ 12/02; + ABS; für Linkslenker	03.2123-2146.3 010572	Ø 23,8
1.9 D Eco	47	01/96→08/03		→ 12/02; - ABS; für Rechtslenker	03.2120-2031.3 010106	ATE Ø 20,6
				→ 12/02; - ABS	03.2120-2031.3 010106	ATE Ø 20,6
				→ 12/02; - ABS; für Linkslenker; nicht für Fahrschulwagen	03.2120-2031.3 010106	ATE Ø 20,6
				06/98→ 12/02; - ABS	03.2122-1541.3 010511	Ø 22,2
				→ 12/02; + ABS; für Linkslenker	24.2120-1723.3 010545	BDX Ø 20,6
				→ 12/02; + ABS; für Linkslenker; nicht für Fahrschulwagen	24.2120-1723.3 010545	BDX Ø 20,6
				→ 03/99; + ABS; für Rechtslenker	24.2120-1725.3 010579	BDX Ø 20,6
				→ 12/02; + ABS; für Rechtslenker	24.2120-1725.3 010579	BDX Ø 20,6
1.9 dT	66	01/96→08/03		→ 12/02; - ABS	03.2120-2031.3 010106	ATE Ø 20,6
					03.2122-1541.3 010511	Ø 22,2
				03/96→ 12/02; - ABS	03.2120-2031.3 010106	ATE Ø 20,6
				→ 12/02; + ABS; für Linkslenker	24.2120-1723.3 010545	BDX Ø 20,6
				→ 12/02; + ABS	24.2120-1723.3 010545	BDX Ø 20,6
1.9 dTi	72	03/97→02/01		- ABS	03.2120-2031.3 010106	ATE Ø 20,6
					03.2122-1541.3 010511	Ø 22,2
				03/99→; + ABS; für Linkslenker	03.2123-2146.3 010572	Ø 23,8
				03/99→; + ABS	03.2123-2146.3 010572	Ø 23,8
				→ 02/99; + ABS	24.2120-1723.3 010545	BDX Ø 20,6
				+ ABS; für Linkslenker	24.2120-1723.3 010545	BDX Ø 20,6
				→ 02/99; + ABS; für Linkslenker	24.2120-1723.3 010545	BDX Ø 20,6
				+ ABS; für Rechtslenker	24.2120-1725.3 010579	BDX Ø 20,6
1.9 TDI	69	09/96→08/03		→ 12/02; - ABS	03.2120-2031.3 010106	ATE Ø 20,6
				→ 12/02; + ABS	24.2120-1723.3 010545	BDX Ø 20,6
2.0 16V	108	07/96→08/03		→ 12/02	24.2123-1701.3 010424	Ø 23,8
2.0 i	80	03/99→08/03		→ 12/02	03.2120-2031.3 010106	ATE Ø 20,6
2.0 i	84	01/96→08/03		→ 12/02; - ABS	03.2120-2031.3 010106	ATE Ø 20,6
					03.2122-1541.3 010511	Ø 22,2
				→ 12/02; + ABS; für Linkslenker	24.2120-1723.3 010545	BDX Ø 20,6
			→ 12/02; + ABS; für Rechtslenker	24.2120-1725.3 010579	BDX Ø 20,6	









RENAULT - MEGANE I Cabriolet (EA0/1_) 10/96→08/03











Bremskraftverstärker













1.4 16V	70	03/99→08/03		+ ABS; für Linkslenker	03.7760-5502.4 300151	ATE Ø 10" pneumatisch
				- ABS	03.7760-5602.4 300121	ATE Ø 10" pneumatisch
				10/00→; + ABS; für Linkslenker	03.7863-2002.4 300126	ATE Ø 10" pneumatisch
1.6 16V	79	03/99→07/03		+ ABS; für Linkslenker	03.7760-5102.4 300140	ATE Ø 10" pneumatisch
				10/00→; - ABS	03.7760-5602.4 300121	ATE Ø 10" pneumatisch
				10/00→; + ABS; für Linkslenker	03.7863-2002.4 300126	ATE Ø 10" pneumatisch
2.0 16V	102	01/02→08/03		für Linkslenker	03.7760-5102.4 300140	ATE Ø 10" pneumatisch
2.0 16V IDE	103	11/99→08/03		für Linkslenker	03.7760-5102.4 300140	ATE Ø 10" pneumatisch
				10/00→; - ABS	03.7760-5602.4 300121	ATE Ø 10" pneumatisch
				10/00→; + ABS; für Linkslenker	03.7863-2002.4 300126	ATE Ø 10" pneumatisch











Hauptbremszylinder













1.4 16V	70	03/99→08/03		- ABS	03.2122-1541.3 010511	Ø 22,2
				10/00→; + ABS; für Linkslenker	03.2123-2146.3 010572	Ø 23,8
1.6 16V	79	03/99→07/03		10/00→; - ABS	03.2122-1541.3 010511	Ø 22,2
				10/00→; + ABS; für Linkslenker	03.2123-2146.3 010572	Ø 23,8
				+ ABS; für Linkslenker	03.2123-2146.3 010572	Ø 23,8
2.0	84	04/97→08/03		- ABS; für Linkslenker	03.2120-2031.3 010106	ATE Ø 20,6
2.0 i	80	03/99→08/03		+ ABS; für Linkslenker	24.2120-1723.3 010545	BDX Ø 20,6











	kw				! #		
RENAULT - MEGANE I Cabriolet (EA0/1_) 10/96→08/03							
 Hauptbremszylinder							
2.0 2.0 i	84 80	04/97→08/03 03/99→08/03		+ ABS; für Rechtslenker		24.2120-1725.3 010579	BDX Ø 20,6
2.0 16V	102	01/02→08/03		für Linkslenker		03.2123-2146.3 010572	Ø 23,8
2.0 16V IDE	103	11/99→08/03		10/00→; - ABS		03.2122-1541.3 010511	Ø 22,2
				für Linkslenker		03.2123-2146.3 010572	Ø 23,8
				10/00→; + ABS; für Linkslenker		03.2123-2146.3 010572	Ø 23,8
RENAULT - MEGANE I Classic (LA0/1_) 09/96→08/08							
 Bremskraftverstärker							
1.4	55	09/96→08/03		09/98→ 12/02; + ABS		03.7760-5502.4 300151	ATE Ø 10" pneumatisch
				04/98→ 12/02; + ABS		03.7760-5602.4 300121	ATE Ø 10" pneumatisch
1.4 16V	70	03/99→08/03		→ 12/02; + ABS; für Linkslenker		03.7760-5502.4 300151	ATE Ø 10" pneumatisch
				→ 12/02; - ABS		03.7863-2002.4 300126	ATE Ø 10" pneumatisch
1.6	64	02/00→09/00		+ ABS		03.7760-5502.4 300151	ATE Ø 10" pneumatisch
				- ABS		03.7760-5602.4 300121	ATE Ø 10" pneumatisch
1.6 16V	81	09/99→12/01		+ ABS; für Linkslenker; für Fahrzeuge ohne verstärktes Fahrwerk		03.7760-5102.4 300140	ATE Ø 10" pneumatisch
				+ ABS		03.7760-5502.4 300151	ATE Ø 10" pneumatisch
				+ ABS; für Linkslenker; für Fahrzeuge mit verstärktem Fahrwerk		03.7760-5502.4 300151	ATE Ø 10" pneumatisch
				- ABS		03.7760-5602.4 300121	ATE Ø 10" pneumatisch
1.6 16V	79	03/99→07/03		- ABS; für Fahrzeuge mit verstärktem Fahrwerk		03.7760-5602.4 300121	ATE Ø 10" pneumatisch
				→ 12/02; + ABS; für Linkslenker; für Fahrzeuge ohne verstärktes Fahrwerk		03.7760-5102.4 300140	ATE Ø 10" pneumatisch
				09/99→ 12/02; + ABS		03.7760-5502.4 300151	ATE Ø 10" pneumatisch
				→ 12/02; + ABS; für Linkslenker; für Fahrzeuge mit verstärktem Fahrwerk		03.7760-5502.4 300151	ATE Ø 10" pneumatisch
1.6 16V	79	03/99→07/03		→ 12/02; - ABS; für Fahrzeuge mit verstärktem Fahrwerk		03.7760-5602.4 300121	ATE Ø 10" pneumatisch
				09/99→ 12/02; - ABS		03.7760-5602.4 300121	ATE Ø 10" pneumatisch
1.8 16V	85	01/01→08/03		→ 12/02; + ABS; für Linkslenker		03.7863-2002.4 300126	ATE Ø 10" pneumatisch
1.9 D	47	09/96→08/03		09/98→ 12/02; + ABS; für Linkslenker		03.7760-5502.4 300151	ATE Ø 10" pneumatisch
				09/98→ 12/02; - ABS		03.7760-5602.4 300121	ATE Ø 10" pneumatisch
1.9 dCi	75	02/01→08/03		→ 12/02; + ABS; für Linkslenker		03.7760-5102.4 300140	ATE Ø 10" pneumatisch
						03.7863-2002.4 300126	ATE Ø 10" pneumatisch
1.9 dTi	72	03/97→02/01		03/99→; für Linkslenker		03.7760-5102.4 300140	ATE Ø 10" pneumatisch
				03/99→; + ABS; für Linkslenker		03.7760-5502.4 300151	ATE Ø 10" pneumatisch
				- ABS		03.7760-5602.4 300121	ATE Ø 10" pneumatisch
				+ ABS; für Linkslenker		03.7863-2002.4 300126	ATE Ø 10" pneumatisch
1.9 TDI	69	09/96→08/03		→ 12/02; + ABS		03.7760-5502.4 300151	ATE Ø 10" pneumatisch
				→ 12/02; - ABS		03.7760-5602.4 300121	ATE Ø 10" pneumatisch
2.0	85	05/98→05/01		09/98→; + ABS; für Linkslenker		03.7760-5502.4 300151	ATE Ø 10" pneumatisch
				- ABS; für Linkslenker		03.7760-5602.4 300121	ATE Ø 10" pneumatisch
2.0 i	84	09/96→08/03		09/98→ 12/02; + ABS; für Linkslenker		03.7760-5502.4 300151	ATE Ø 10" pneumatisch
				→ 12/02; - ABS; für Linkslenker		03.7760-5602.4 300121	ATE Ø 10" pneumatisch
2.0 RT	103	03/01→08/03		→ 02/03; - ABS		03.7760-5602.4 300121	ATE Ø 10" pneumatisch
				→ 02/03; + ABS; für Linkslenker		03.7863-2002.4 300126	ATE Ø 10" pneumatisch
 Hauptbremszylinder							
1.4	55	09/96→08/03		→ 12/02; - ABS		03.2120-2031.3 010106	ATE Ø 20,6
				04/98→ 12/02; - ABS		03.2122-1541.3 010511	Ø 22,2
				09/98→ 02/99; + ABS		24.2120-1723.3 010545	BDX Ø 20,6
				→ 12/02; + ABS		24.2120-1723.3 010545	BDX Ø 20,6
1.4 16V	70	03/99→08/03		→ 12/02; - ABS		03.2122-1541.3 010511	Ø 22,2
1.9 TDI	69	09/96→08/03					
1.6	64	02/00→09/00		- ABS		03.2122-1541.3 010511	Ø 22,2
1.6 16V	81	09/99→12/01		- ABS		03.2122-1541.3 010511	Ø 22,2
				- ABS; für Fahrzeuge mit verstärktem Fahrwerk		03.2122-1541.3 010511	Ø 22,2
				+ ABS; für Linkslenker; für Fahrzeuge ohne verstärktes Fahrwerk		03.2123-2146.3 010572	Ø 23,8
1.6 16V	79	03/99→07/03		09/99→ 12/02; - ABS		03.2122-1541.3 010511	Ø 22,2
→							













	kw					! #		
RENAULT - MEGANE I Classic (LA0/1_) 09/96→08/08								
 Hauptbremszylinder								
1.6 16V	79	03/99→07/03		→ 12/02; - ABS; für Fahrzeuge mit verstärktem Fahrwerk		03.2122-1541.3	010511	Ø 22,2
				→ 12/02; + ABS; für Linkslenker; für Fahrzeuge ohne verstärktes Fahrwerk		03.2123-2146.3	010572	Ø 23,8
1.8 16V	85	01/01→08/03		→ 12/02; + ABS; für Linkslenker		03.2123-2146.3	010572	Ø 23,8
1.9 D	47	09/96→08/03		→ 12/02; - ABS		03.2120-2031.3	010106	ATE Ø 20,6
				09/98→ 12/02; - ABS		03.2122-1541.3	010511	Ø 22,2
				→ 12/02; + ABS		24.2120-1723.3	010545	BDX Ø 20,6
				→ 12/02; + ABS; für Linkslenker		24.2120-1723.3	010545	BDX Ø 20,6
				→ 12/02; + ABS; für Rechtslenker		24.2120-1725.3	010579	BDX Ø 20,6
1.9 dCi	75	02/01→08/03		→ 12/02; - ABS		03.2122-1541.3	010511	Ø 22,2
				→ 12/02; + ABS; für Linkslenker		03.2123-2146.3	010572	Ø 23,8
1.9 dT	66	09/96→08/03		→ 12/02; - ABS		03.2120-2031.3	010106	ATE Ø 20,6
				→ 12/02; + ABS		24.2120-1723.3	010545	BDX Ø 20,6
				→ 12/02; + ABS; für Linkslenker		24.2120-1723.3	010545	BDX Ø 20,6
				→ 12/02; + ABS; für Rechtslenker		24.2120-1725.3	010579	BDX Ø 20,6
1.9 dTi	72	03/97→02/01		- ABS		03.2120-2031.3	010106	ATE Ø 20,6
				03/99→; - ABS; für Linkslenker		03.2122-1541.3	010511	Ø 22,2
				+ ABS; für Linkslenker; für Fahrzeuge ohne verstärktes Fahrwerk		03.2123-2146.3	010572	Ø 23,8
				+ ABS; für Linkslenker		03.2123-2146.3	010572	Ø 23,8
				+ ABS; für Rechtslenker		24.2120-1725.3	010579	BDX Ø 20,6
				→ 02/99; + ABS; für Rechtslenker		24.2120-1725.3	010579	BDX Ø 20,6
2.0	85	05/98→05/01		- ABS		03.2120-2031.3	010106	ATE Ø 20,6
						03.2120-2031.3	010106	ATE Ø 20,6
				03/99→; - ABS; für Linkslenker		03.2122-1541.3	010511	Ø 22,2
				+ ABS; für Linkslenker		24.2120-1723.3	010545	BDX Ø 20,6
				+ ABS; für Rechtslenker		24.2120-1725.3	010579	BDX Ø 20,6
2.0 i	84	09/96→08/03		→ 12/02; - ABS		03.2120-2031.3	010106	ATE Ø 20,6
				→ 12/02		03.2120-2031.3	010106	ATE Ø 20,6
				03/99→ 12/02; - ABS; für Linkslenker		03.2122-1541.3	010511	Ø 22,2
				→ 12/02; + ABS; für Linkslenker		24.2120-1723.3	010545	BDX Ø 20,6
				→ 12/02; + ABS; für Rechtslenker		24.2120-1725.3	010579	BDX Ø 20,6
2.0 RT	103	03/01→08/03		→ 02/03; - ABS		03.2122-1541.3	010511	Ø 22,2
				→ 02/03; + ABS; für Linkslenker		03.2123-2146.3	010572	Ø 23,8
RENAULT - MEGANE I Coach (DA0/1_) 03/96→08/03								
 Bremskraftverstärker								
1.4 16V	70	03/99→07/03		→ 02/03; + ABS; für Linkslenker		03.7760-5502.4	300151	ATE Ø 10" pneumatisch
				→ 02/03; - ABS		03.7760-5602.4	300121	ATE Ø 10" pneumatisch
				10/00→ 02/03; + ABS; für Linkslenker		03.7863-2002.4	300126	ATE Ø 10" pneumatisch
1.6 16V	79	03/99→07/03		→ 02/03; + ABS; für Linkslenker		03.7760-5102.4	300140	ATE Ø 10" pneumatisch
				10/00→ 02/03; - ABS		03.7760-5602.4	300121	ATE Ø 10" pneumatisch
				10/00→ 02/03; + ABS; für Linkslenker		03.7863-2002.4	300126	ATE Ø 10" pneumatisch
1.9 dCi	75	02/01→08/03		→ 02/03; + ABS; für Linkslenker		03.7760-5102.4	300140	ATE Ø 10" pneumatisch
						03.7863-2002.4	300126	ATE Ø 10" pneumatisch
1.9 dTi	72	03/97→02/01		03/99→; für Linkslenker		03.7760-5102.4	300140	ATE Ø 10" pneumatisch
2.0 16V	102	01/02→08/03		→ 02/03; für Linkslenker		03.7760-5102.4	300140	ATE Ø 10" pneumatisch
				→ 02/03; - ABS		03.7760-5602.4	300121	ATE Ø 10" pneumatisch
				→ 02/03; + ABS; für Linkslenker		03.7863-2002.4	300126	ATE Ø 10" pneumatisch
2.0 16V IDE	103	11/99→08/03		→ 02/03; für Linkslenker		03.7760-5102.4	300140	ATE Ø 10" pneumatisch
				10/00→ 02/03; - ABS		03.7760-5602.4	300121	ATE Ø 10" pneumatisch
				10/00→ 02/03; + ABS; für Linkslenker		03.7863-2002.4	300126	ATE Ø 10" pneumatisch
 Hauptbremszylinder								
1.4 16V	70	03/99→07/03		→ 02/03; - ABS		03.2122-1541.3	010511	Ø 22,2
				10/00→ 02/03; + ABS; für Linkslenker		03.2123-2146.3	010572	Ø 23,8
1.6 16V	79	03/99→07/03		10/00→ 02/03; - ABS		03.2122-1541.3	010511	Ø 22,2
				10/00→ 02/03; + ABS; für Linkslenker		03.2123-2146.3	010572	Ø 23,8
				→ 02/03; + ABS; für Linkslenker		03.2123-2146.3	010572	Ø 23,8
→								













	kw					! #		
RENAULT - MEGANE I Coach (DA0/1_) 03/96→08/03								
 Hauptbremszylinder								
1.9 dCi 2.0 16V	75 102	02/01→08/03 01/02→08/03		→ 02/03; - ABS			03.2122-1541.3 010511	Ø 22,2
				→ 02/03; + ABS; für Linkslenker			03.2123-2146.3 010572	Ø 23,8
1.9 dTi	72	03/97→02/01		05/97→; - ABS			03.2120-2031.3 010106	ATE Ø 20,6
				03/99→; + ABS			03.2123-2146.3 010572	Ø 23,8
				05/97→ 02/99; + ABS			24.2120-1723.3 010545	BDX Ø 20,6
2.0 16V IDE	103	11/99→08/03		10/00→ 02/03; - ABS			03.2122-1541.3 010511	Ø 22,2
				→ 02/03; für Linkslenker			03.2123-2146.3 010572	Ø 23,8
				10/00→ 02/03; + ABS; für Linkslenker			03.2123-2146.3 010572	Ø 23,8
2.0 i	80 - 84	03/96→08/03		→ 02/03; - ABS; für Linkslenker			03.2120-2031.3 010106	ATE Ø 20,6
				→ 02/03; + ABS; für Linkslenker			24.2120-1723.3 010545	BDX Ø 20,6
				→ 02/03; + ABS; für Rechtslenker			24.2120-1725.3 010579	BDX Ø 20,6
RENAULT - MEGANE I Grandtour (KA0/1_) 03/99→08/03								
 Bremskraftverstärker								
1.4 16V	70	03/99→08/03		+ ABS; für Fahrzeuge mit verstärktem Fahrwerk			03.7760-5502.4 300151	ATE Ø 10" pneumatisch
				- ABS			03.7760-5602.4 300121	ATE Ø 10" pneumatisch
				+ ABS; für Linkslenker			03.7863-2002.4 300126	ATE Ø 10" pneumatisch
1.4 e 1.6 e 1.9 D	55 66 47	03/99→08/03 03/99→08/03 04/99→08/03		+ ABS; für Fahrzeuge mit verstärktem Fahrwerk			03.7760-5502.4 300151	ATE Ø 10" pneumatisch
				- ABS			03.7760-5602.4 300121	ATE Ø 10" pneumatisch
1.6 16V	79	03/99→08/03		+ ABS; für Linkslenker; für Fahrzeuge ohne verstärktes Fahrwerk			03.7760-5102.4 300140	ATE Ø 10" pneumatisch
				- ABS			03.7760-5602.4 300121	ATE Ø 10" pneumatisch
				+ ABS; für Linkslenker			03.7863-2002.4 300126	ATE Ø 10" pneumatisch
1.6 Bifuel	80	03/99→09/00		- ABS			03.7760-5602.4 300121	ATE Ø 10" pneumatisch
1.8 16V	85	01/01→08/03		+ ABS; für Linkslenker			03.7863-2002.4 300126	ATE Ø 10" pneumatisch
1.9 dCi	75	02/01→08/03		+ ABS; für Linkslenker; für Fahrzeuge ohne verstärktes Fahrwerk			03.7760-5102.4 300140	ATE Ø 10" pneumatisch
				+ ABS; für Linkslenker			03.7863-2002.4 300126	ATE Ø 10" pneumatisch
1.9 dTi	72	03/99→02/01		+ ABS; für Linkslenker; für Fahrzeuge ohne verstärktes Fahrwerk			03.7760-5102.4 300140	ATE Ø 10" pneumatisch
				- ABS			03.7760-5602.4 300121	ATE Ø 10" pneumatisch
1.9 dTi	59	02/01→08/03		- ABS			03.7760-5602.4 300121	ATE Ø 10" pneumatisch
				+ ABS; für Linkslenker			03.7863-2002.4 300126	ATE Ø 10" pneumatisch
 Hauptbremszylinder								
1.4 16V 1.4 e 1.6 e 1.9 D	70 55 66 47	03/99→08/03 03/99→08/03 03/99→08/03 04/99→08/03		- ABS			03.2122-1541.3 010511	Ø 22,2
1.6 16V 1.6 Bifuel 1.9 dCi 1.9 dTi	79 80 75 72	03/99→08/03 03/99→09/00 02/01→08/03 03/99→02/01		- ABS			03.2123-1551.3 010512	Ø 23,8
				+ ABS			03.2123-2146.3 010572	Ø 23,8
1.8 16V	85	01/01→08/03		+ ABS			03.2123-2146.3 010572	Ø 23,8
							03.2123-2621.3 010701	ATE Ø 23,8
1.9 dTi	59	02/01→08/03		- ABS			03.2123-2146.3 010572	Ø 23,8
				+ ABS			03.2123-2621.3 010701	ATE Ø 23,8
RENAULT - MEGANE I Hatchback Van (SA0/1_) 08/95→07/03								
 Bremskraftverstärker								
1.9	47	08/95→09/00		06/98→; + ABS; für Linkslenker			03.7760-5502.4 300151	ATE Ø 10" pneumatisch
				06/98→; - ABS			03.7760-5602.4 300121	ATE Ø 10" pneumatisch
1.9 dCi	59	10/00→07/03		+ ABS; für Linkslenker			03.7863-2002.4 300126	ATE Ø 10" pneumatisch
 Hauptbremszylinder								
1.9	47	08/95→09/00		- ABS; für Rechtslenker			03.2120-2031.3 010106	ATE Ø 20,6
				- ABS			03.2120-2031.3 010106	ATE Ø 20,6
				- ABS; für Linkslenker; nicht für Fahrschulwagen			03.2120-2031.3 010106	ATE Ø 20,6
				06/98→; - ABS			03.2122-1541.3 010511	Ø 22,2
				+ ABS; für Linkslenker			24.2120-1723.3 010545	BDX Ø 20,6
				+ ABS; für Linkslenker; nicht für Fahrschulwagen			24.2120-1723.3 010545	BDX Ø 20,6
→								











	kw					! #		
RENAULT - MEGANE I Hatchback Van (SA0/1_) 08/95→07/03								
 Hauptbremszylinder								
1.9	47	08/95→09/00		+ ABS; für Rechtslenker		24.2120-1725.3	010579	BDX Ø 20,6
				→ 03/99; + ABS; für Rechtslenker		24.2120-1725.3	010579	BDX Ø 20,6
1.9 dCi	59	10/00→07/03		+ ABS; für Linkslenker		03.2123-2146.3	010572	Ø 23,8
RENAULT - Megane I Kombi van (KA_) 02/00→07/03								
 Bremskraftverstärker								
1.4	70	04/01→07/03		+ ABS; für Fahrzeuge mit verstärktem Fahrwerk		03.7760-5502.4	300151	ATE Ø 10" pneumatisch
				- ABS		03.7760-5602.4	300121	ATE Ø 10" pneumatisch
				+ ABS; für Linkslenker		03.7863-2002.4	300126	ATE Ø 10" pneumatisch
1.6 1.6 BiFuel	79 79 - 80	04/01→07/03 04/01→07/03		+ ABS; für Linkslenker; für Fahrzeuge ohne verstärktes Fahrwerk		03.7760-5102.4	300140	ATE Ø 10" pneumatisch
				- ABS		03.7760-5602.4	300121	ATE Ø 10" pneumatisch
				+ ABS; für Linkslenker		03.7863-2002.4	300126	ATE Ø 10" pneumatisch
1.8	85	04/01→07/03		+ ABS; für Linkslenker		03.7863-2002.4	300126	ATE Ø 10" pneumatisch
1.9 D	47	02/00→09/00		+ ABS; für Fahrzeuge mit verstärktem Fahrwerk		03.7760-5502.4	300151	ATE Ø 10" pneumatisch
				- ABS		03.7760-5602.4	300121	ATE Ø 10" pneumatisch
1.9 dCi	75 - 77	04/01→07/03		+ ABS; für Linkslenker; für Fahrzeuge ohne verstärktes Fahrwerk		03.7760-5102.4	300140	ATE Ø 10" pneumatisch
				+ ABS; für Linkslenker		03.7863-2002.4	300126	ATE Ø 10" pneumatisch
1.9 DTI	59	04/01→07/03		- ABS		03.7760-5602.4	300121	ATE Ø 10" pneumatisch
				+ ABS; für Linkslenker		03.7863-2002.4	300126	ATE Ø 10" pneumatisch
 Hauptbremszylinder								
1.4 1.9 D	70 47	04/01→07/03 02/00→09/00		- ABS		03.2122-1541.3	010511	Ø 22,2
1.6 1.6 BiFuel	79 79 - 80	04/01→07/03 04/01→07/03		- ABS		03.2123-1551.3	010512	Ø 23,8
				+ ABS		03.2123-2146.3	010572	Ø 23,8
1.9 dCi	75 - 77	04/01→07/03						
1.8	85	04/01→07/03		+ ABS		03.2123-2146.3	010572	Ø 23,8
						03.2123-2621.3	010701	ATE Ø 23,8
1.9 DTI	59	04/01→07/03		- ABS		03.2123-2146.3	010572	Ø 23,8
				+ ABS		03.2123-2621.3	010701	ATE Ø 23,8
RENAULT - MEGANE II (BM0/1_, CM0/1_) 07/01→10/12								
 Hauptbremszylinder								
1.4 16V	60 - 72	11/02→02/08				24.2123-1760.3	010779	TRW Ø 23,8
1.5 dCi	63 - 78	10/03→06/08				24.4123-1721.3	011052	BOS Ø 23,8 ohne Bremsflüssigkeitsbehälter
1.6	77 - 79	06/05→01/11						
1.6 16V	82 - 83	11/02→06/08						
1.6 Flex-Fuel	77	01/07→02/08						
1.9 dCi	88	11/02→02/08						
2.0	169	08/06→02/08						
2.0 16V	99	11/02→02/08						
2.0 16V Turbo	120	05/04→02/08						
2.0 dCi	110 - 127	09/05→02/08						
1.5 dCi	60	09/02→02/08		11/02→		24.2123-1760.3	010779	TRW Ø 23,8
						24.4123-1721.3	011052	BOS Ø 23,8 ohne Bremsflüssigkeitsbehälter
1.5 dCi 1.9 dCi 2.0 Renault Sport	76 96 165	01/07→03/09 05/05→12/09 05/04→10/09		→ 11/08		24.2123-1760.3	010779	TRW Ø 23,8
						24.4123-1721.3	011052	BOS Ø 23,8 ohne Bremsflüssigkeitsbehälter
1.6 Bifuel	77	06/05→02/08		01/07→		24.2123-1760.3	010779	TRW Ø 23,8
						24.4123-1721.3	011052	BOS Ø 23,8 ohne Bremsflüssigkeitsbehälter
1.9 dCi	66	11/02→12/05				24.4123-1721.3	011052	BOS Ø 23,8 ohne Bremsflüssigkeitsbehälter
1.9 dCi	68 - 85	11/02→02/08		01/06→		24.2123-1760.3	010779	TRW Ø 23,8
						24.4123-1721.3	011052	BOS Ø 23,8 ohne Bremsflüssigkeitsbehälter

	kw					! #		
RENAULT - MEGANE II Coupé-Cabriolet (EM0/1_) 09/03→03/10								
 Hauptbremszylinder								
1.5 dCi 1.6	76 77 - 83	01/07→06/09 09/03→03/09					24.2123-1760.3 010779 24.4123-1721.3 011052	TRW Ø 23,8 BOS Ø 23,8 ohne Bremsflüssigkeitsbehälter
1.9 dCi	81 - 96	09/03→03/09						
2.0 2.0 16V Turbo 2.0 dCi	102 120 110	09/03→02/07 05/04→03/09 09/05→03/09						
1.5 dCi	78	03/06→01/09		→ 06/08			24.2123-1760.3 010779 24.4123-1721.3 011052	TRW Ø 23,8 BOS Ø 23,8 ohne Bremsflüssigkeitsbehälter
1.6 16V	82	01/06→06/08		01/07→			24.2123-1760.3 010779 24.4123-1721.3 011052	TRW Ø 23,8 BOS Ø 23,8 ohne Bremsflüssigkeitsbehälter
1.9 dCi	85	09/03→03/09		01/06→			24.2123-1760.3 010779 24.4123-1721.3 011052	TRW Ø 23,8 BOS Ø 23,8 ohne Bremsflüssigkeitsbehälter
2.0	99	09/03→12/09		→ 03/07			24.2123-1760.3 010779 24.4123-1721.3 011052	TRW Ø 23,8 BOS Ø 23,8 ohne Bremsflüssigkeitsbehälter
RENAULT - MEGANE II Hatchback Van (KM0/2_) 08/03→07/09								
 Hauptbremszylinder								
1.5 dCi	60 - 78	08/03→03/09					24.2123-1760.3 010779 24.4123-1721.3 011052	TRW Ø 23,8 BOS Ø 23,8 ohne Bremsflüssigkeitsbehälter
RENAULT - MEGANE II Kasten/Kombi (KM_) 08/03→07/09								
 Hauptbremszylinder								
1.5 dCi 1.6 1.9 dCi	60 - 78 82 96	08/03→07/09 10/03→01/08 02/06→10/06					24.2123-1760.3 010779 24.4123-1721.3 011052	TRW Ø 23,8 BOS Ø 23,8 ohne Bremsflüssigkeitsbehälter
RENAULT - MEGANE II Kombi (KM0/1_) 08/03→08/12								
 Hauptbremszylinder								
1.4 1.6 1.9 dCi 2.0	72 83 88 99	08/03→07/09 08/03→07/09 08/03→07/09 08/03→07/09		09/03→ 12/08			24.2123-1760.3 010779 24.4123-1721.3 011052	TRW Ø 23,8 BOS Ø 23,8 ohne Bremsflüssigkeitsbehälter
1.5 dCi 1.6 16V 1.6 LPG 16V 1.9 dCi 2.0	63 - 78 75 - 77 82 66 - 68 102	02/04→07/09 05/05→07/09 01/06→08/09 03/04→02/07 12/06→01/11					24.2123-1760.3 010779 24.4123-1721.3 011052	TRW Ø 23,8 BOS Ø 23,8 ohne Bremsflüssigkeitsbehälter
1.5 dCi	60	08/03→05/06		09/03→			24.2123-1760.3 010779 24.4123-1721.3 011052	TRW Ø 23,8 BOS Ø 23,8 ohne Bremsflüssigkeitsbehälter
1.5 dCi 1.6 16V Hi-Flex 1.9 dCi 2.0 dCi	76 77 81 - 85 110	01/07→07/09 02/08→07/09 05/05→07/09 09/05→07/09		→ 12/08			24.2123-1760.3 010779 24.4123-1721.3 011052	TRW Ø 23,8 BOS Ø 23,8 ohne Bremsflüssigkeitsbehälter
1.6 16V	81	05/06→10/11		→ 07/09			24.2123-1760.3 010779 24.4123-1721.3 011052	TRW Ø 23,8 BOS Ø 23,8 ohne Bremsflüssigkeitsbehälter
1.6 16V	82	01/06→08/09		01/07→ 12/08			24.2123-1760.3 010779 24.4123-1721.3 011052	TRW Ø 23,8 BOS Ø 23,8 ohne Bremsflüssigkeitsbehälter
1.9 dCi	96	05/05→07/09		→ 02/07			24.2123-1760.3 010779 24.4123-1721.3 011052	TRW Ø 23,8 BOS Ø 23,8 ohne Bremsflüssigkeitsbehälter
RENAULT - MEGANE II Stufenheck (LM0/1_) 08/03→								
 Hauptbremszylinder								
1.4	60	09/03→		→ 08/06			24.2123-1760.3 010779 24.4123-1721.3 011052	TRW Ø 23,8 BOS Ø 23,8 ohne Bremsflüssigkeitsbehälter
→								















	kW					! #		
RENAULT - MEGANE II Stufenheck (LM0/1_) 08/03→								
 Hauptbremszylinder								
1.4 1.5 dCi 1.6 1.6 Hi-Flex 1.9 dCi 2.0 dCi	72 78 77 83 85 81 96 110	09/03→ 05/05→12/10 09/03→ 03/06→ 09/03→ 09/05→			→ 12/08		24.2123-1760.3 010779 24.4123-1721.3 011052	TRW Ø 23,8 BOS Ø 23,8 ohne Bremsflüssigkeitsbehälter
1.5 dCi	74	02/04→12/10			→ 03/06; für Fahrzeuge ohne Sportfahrwerk → 03/06; für Fahrzeuge mit Sportfahrwerk → 03/06		24.2123-1760.3 010779 24.2125-1742.3 010978 24.4123-1721.3 011052	TRW Ø 23,8 TRW Ø 25,4 BOS Ø 23,8 ohne Bremsflüssigkeitsbehälter
1.5 dCi	60	08/03→12/10			09/03→ 12/08		24.2123-1760.3 010779 24.4123-1721.3 011052	TRW Ø 23,8 BOS Ø 23,8 ohne Bremsflüssigkeitsbehälter
1.5 dCi	76	10/03→12/10			01/07→; für Fahrzeuge ohne Sportfahrwerk; → 12/08 01/07→; für Fahrzeuge mit Sportfahrwerk; → 12/08 01/07→ 12/08		24.2123-1760.3 010779 24.2125-1742.3 010978 24.4123-1721.3 011052	TRW Ø 23,8 TRW Ø 25,4 BOS Ø 23,8 ohne Bremsflüssigkeitsbehälter
1.5 dCi 1.9 dCi 2.0	63 68 99	05/05→12/10 03/04→ 09/03→			für Fahrzeuge ohne Sportfahrwerk; → 12/08 für Fahrzeuge mit Sportfahrwerk; → 12/08 → 12/08		24.2123-1760.3 010779 24.2125-1742.3 010978 24.4123-1721.3 011052	TRW Ø 23,8 TRW Ø 25,4 BOS Ø 23,8 ohne Bremsflüssigkeitsbehälter
1.6 2.0	81 101	09/03→11/08 04/06→11/10					24.2123-1760.3 010779 24.4123-1721.3 011052	TRW Ø 23,8 BOS Ø 23,8 ohne Bremsflüssigkeitsbehälter
1.6 16V	82	01/06→			01/07→ 12/08		24.2123-1760.3 010779 24.4123-1721.3 011052	TRW Ø 23,8 BOS Ø 23,8 ohne Bremsflüssigkeitsbehälter
1.9 dCi	66	09/03→12/05			für Fahrzeuge ohne Sportfahrwerk für Fahrzeuge mit Sportfahrwerk		24.2123-1760.3 010779 24.2125-1742.3 010978 24.4123-1721.3 011052	TRW Ø 23,8 TRW Ø 25,4 BOS Ø 23,8 ohne Bremsflüssigkeitsbehälter
RENAULT - MEGANE III Combi Van (KZ0/1) 01/09→08/15								
 Hauptbremszylinder								
1.5 dCi	63 - 81	01/09→08/15					24.4123-1715.3 010980	TRW Ø 23,8
RENAULT - MEGANE III Coupe (DZ0/1_) 11/08→09/16								
 Hauptbremszylinder								
1.2 TCe 1.4 TCe 1.5 dCi 1.6 16V 1.6 16V Bifuel 1.6 dCi 1.9 dCi 2.0 CVT 2.0 dCi 2.0 TCe	85 - 97 96 63 - 81 74 - 81 81 96 96 103 110 - 120 132 - 184	03/12→08/15 04/09→08/15 11/08→08/15 11/08→08/15 11/08→08/15 04/11→08/15 11/08→08/15 05/09→08/15 04/09→08/15 11/08→08/15 11/08→08/15					24.4123-1715.3 010980	TRW Ø 23,8
RENAULT - MEGANE III Grandtour (KZ0/1) 11/08→01/16								
 Hauptbremszylinder								
1.2 TCe 1.4 TCe 1.5 dCi 1.6 16V 1.6 BiFuel 1.6 dCi →	85 - 97 96 63 - 81 74 - 81 81 96	03/12→01/16 05/09→08/15 02/09→08/15 05/09→08/15 11/08→08/15 04/11→08/15					24.4123-1715.3 010980	TRW Ø 23,8













	kW					! #		
RENAULT - MEGANE III Grandtour (KZ0/1) 11/08→01/16								
 Hauptbremszylinder								
1.9 dCi	96	05/09→08/15					24.4123-1715.3 010980	TRW Ø 23,8
2.0 CVT	103	05/09→08/15						
2.0 dCi	110 - 120	04/09→08/15						
2.0 TCe	140 - 162	09/12→01/16						
2.0 TCe	132	11/08→08/15		05/09→			24.4123-1715.3 010980	TRW Ø 23,8
RENAULT - MEGANE III Hatchback Van (BZ_) 11/08→08/15								
 Hauptbremszylinder								
1.5 dCi	66 - 81	11/08→08/15					24.4123-1715.3 010980	TRW Ø 23,8
RENAULT - MEGANE III Schrägheck (BZ0/1_, B3_) 11/08→								
 Hauptbremszylinder								
1.2 TCe	85 - 97	03/12→01/16					24.4123-1715.3 010980	TRW Ø 23,8
1.4 TCe	96	04/09→08/15						
1.5 dCi	63 - 81	11/08→01/16						
1.6	86	01/14→01/16						
1.6 16V	74 - 85	11/08→03/17						
1.6 16V BiFuel	81	05/09→08/15						
1.6 16V Hi-Flex	81	11/08→08/15						
1.6 dCi	96	04/11→08/15						
1.9 dCi	96	11/08→01/16						
2.0	105	01/11→08/15						
2.0 CVT	103	02/09→08/15						
2.0 dCi	110 - 120	04/09→08/15						
2.0 TCe	132	11/08→08/15						
RENAULT - MEGANE CC (EZ0/1_) 06/10→08/15								
 Hauptbremszylinder								
1.2 TCe	85	09/12→08/15					24.4123-1715.3 010980	TRW Ø 23,8
1.4 TCe	96	06/10→08/15						
1.5 dCi	78 - 81	06/10→08/15						
1.6 16V	81	06/10→08/15						
1.6 16V Hi-Flex	81	06/10→08/15						
1.6 dCi	96	04/11→08/15						
1.9 dCi	96	06/10→08/15						
2.0 CVT	103	06/10→08/15						
2.0 dCi	118	06/10→08/15						
2.0 TCe	132	06/10→08/15						
1.2 TCe	97	01/13→08/15		04/13→			24.4123-1715.3 010980	TRW Ø 23,8
RENAULT - MODUS / GRAND MODUS (F/JP0_) 09/04→								
 Bremskraftverstärker								
1.2	76	04/11→		→ 06/13			03.7863-1232.4 300314	ATE Ø 10" pneumatisch
1.2 16V Hi-Flex	55	10/08→						
1.5 dCi 75	55	10/10→						
1.5 dCi 90	65	10/10→						
1.2	48 - 58	12/04→		für Linkslenker; → 06/13; + ABS			03.7863-4502.4 300230	ATE Ø 10" pneumatisch
1.2 16V	74	05/07→						
1.2	55	12/04→		für Linkslenker; → 01/05			03.7863-1232.4 300314	ATE Ø 10" pneumatisch
				für Linkslenker; → 06/13; + ABS			03.7863-4502.4 300230	ATE Ø 10" pneumatisch
1.2 GPL	55	05/08→12/12					03.7863-1232.4 300314	ATE Ø 10" pneumatisch
1.4	72	12/04→		für Linkslenker; → 01/05			03.7863-1232.4 300314	ATE Ø 10" pneumatisch
				02/05→; für Linkslenker; → 10/07; + ABS			03.7863-4502.4 300230	ATE Ø 10" pneumatisch
1.5 dCi	50 - 63	09/04→		für Linkslenker; → 01/05			03.7863-1232.4 300314	ATE Ø 10" pneumatisch
1.6	65 - 82	12/04→		02/05→; für Linkslenker; → 06/13; + ABS			03.7863-4502.4 300230	ATE Ø 10" pneumatisch
1.5 dCi	48	12/04→		02/05→; für Linkslenker; → 06/13; + ABS			03.7863-4502.4 300230	ATE Ø 10" pneumatisch
1.5 dCi	76	05/07→		11/07→ 06/13			03.7863-1232.4 300314	ATE Ø 10" pneumatisch
				→ 10/07; für Linkslenker; + ABS			03.7863-4502.4 300230	ATE Ø 10" pneumatisch
 Hauptbremszylinder								
1.2	48 - 76	12/04→		für Linkslenker; → 06/13; - ESP			03.2123-3241.3 010882	ATE Ø 23,8
1.5 dCi 75	55	10/10→		für Linkslenker; → 06/13; + ESP			03.2123-3493.3 010792	ATE Ø 23,8
→								















	kw					! #		
RENAULT - MODUS / GRAND MODUS (F/JP0_) 09/04 →								
 Hauptbremszylinder								
1.5 dCi 90	65	10/10 →		für Linkslenker; → 06/13; - ESP		03.2123-3241.3 010882	ATE Ø 23,8	
				für Linkslenker; → 06/13; + ESP		03.2123-3493.3 010792	ATE Ø 23,8	
1.2 1.4 1.5 dCi	55 72 50 - 63	12/04 → 12/04 → 12/04 →		für Linkslenker; → 06/13; - ABS		03.2123-2821.3 010944	ATE Ø 23,8	
				für Linkslenker; → 01/05; + ESP		03.2123-2923.3 010791	ATE Ø 23,8	
				02/05 →; für Linkslenker; → 06/13; - ESP		03.2123-3241.3 010882	ATE Ø 23,8	
				02/05 →; für Linkslenker; → 06/13; + ESP		03.2123-3493.3 010792	ATE Ø 23,8	
1.2 16V 1.5 dCi	74 76	05/07 → 05/07 →		für Linkslenker; → 06/13; - ABS		03.2123-2821.3 010944	ATE Ø 23,8	
				für Linkslenker; → 06/13; - ESP		03.2123-3241.3 010882	ATE Ø 23,8	
				für Linkslenker; → 06/13; + ESP		03.2123-3493.3 010792	ATE Ø 23,8	
1.2 16V Hi-Flex	55	10/08 →		für Linkslenker; → 06/13; - ABS		03.2123-2821.3 010944	ATE Ø 23,8	
1.2 GPL	55	05/08 → 12/12		für Linkslenker; - ABS		03.2123-2821.3 010944	ATE Ø 23,8	
1.5 dCi	60	09/04 →		09/05 →; für Linkslenker; → 06/13; - ABS		03.2123-2821.3 010944	ATE Ø 23,8	
				für Linkslenker; → 01/05; + ESP		03.2123-2923.3 010791	ATE Ø 23,8	
				02/05 →; für Linkslenker; → 06/13; - ESP		03.2123-3241.3 010882	ATE Ø 23,8	
				02/05 →; für Linkslenker; → 06/13; + ESP		03.2123-3493.3 010792	ATE Ø 23,8	
1.5 dCi	48	12/04 →		02/05 →; für Linkslenker; → 06/13; - ESP		03.2123-3241.3 010882	ATE Ø 23,8	
				02/05 →; für Linkslenker; → 06/13; + ESP		03.2123-3493.3 010792	ATE Ø 23,8	
1.5 dCi	78	05/05 →		05/07 →; für Linkslenker; → 06/13; - ESP		03.2123-3241.3 010882	ATE Ø 23,8	
				05/07 →; für Linkslenker; → 06/13; + ESP		03.2123-3493.3 010792	ATE Ø 23,8	
1.6	65 - 82	12/04 →		für Linkslenker; → 06/13; - ABS		03.2123-2821.3 010944	ATE Ø 23,8	
				für Linkslenker; → 01/05; + ESP		03.2123-2923.3 010791	ATE Ø 23,8	
				für Linkslenker; → 06/13; - ESP		03.2123-3241.3 010882	ATE Ø 23,8	
				für Linkslenker; → 06/13; + ESP		03.2123-3493.3 010792	ATE Ø 23,8	
RENAULT - SAFRANE II (B54_) 07/96 → 12/00								
 Hauptbremszylinder								
2.0 16V	100	07/96 → 12/00		08/96 →; für Rechtslenker		24.2122-1707.3 010438	Ø 22,2	
				08/96 →; für Linkslenker		24.2123-1701.3 010424	Ø 23,8	
2.2 dT 2.5 20V 2.9 24V	83 121 140	07/96 → 12/00 07/96 → 12/00 03/99 → 12/00		08/96 →		24.2123-1701.3 010424	Ø 23,8	
3.0 V6	123	07/96 → 12/00		→ 07/96		24.2123-1701.3 010424	Ø 23,8	
				10/96 →		24.2123-1701.3 010424	Ø 23,8	
RENAULT - SANDERO/STEPWAY I (BS_) 11/07 →								
 Bremskraftverstärker								
1.4 1.4 LPG 1.6 1.6 Flex	55 53 62 - 82 82	02/09 → 02/09 → 12/07 → 08/08 →		+ ABS		03.7853-4602.4 300302	ATE Ø 9" pneumatisch	
 Hauptbremszylinder								
1.4 1.4 LPG 1.6 1.6 Flex	55 53 62 - 82 82	02/09 → 02/09 → 12/07 → 08/08 →		+ ABS		03.2120-4611.3 010937	ATE Ø 20,6	
				- ABS		24.2120-1762.3 011002	Ø 20,6 ohne Bremsflüssigkeitsbehälter	
RENAULT - SANDERO/STEPWAY II (B8_) 11/13 →								
 Hauptbremszylinder								
1.0 SCe 75 1.2 16V	54 54 - 55	12/19 → 12/13 →		für Linkslenker; - ABS		24.4120-1714.3 011110	Ø 20,6 ohne Bremsflüssigkeitsbehälter	
1.2 16V LPG 1.5 dCi 1.6	53 62 59 - 83	12/13 → 12/13 → 11/13 →		für Linkslenker; + ABS		24.4120-1771.3 011076	Ø 20,6 ohne Bremsflüssigkeitsbehälter	
1.6 16V 1.6 Flex TCe 90	75 78 66	04/14 → 03/14 → 07/18 09/15 →						
RENAULT - SCÉNIC I Großraumlimousine (JA0/1_, FA0_) 08/99 → 07/10								
 Bremskraftverstärker								
1.4 16V 1.6 →	70 75 - 79	09/99 → 08/03 09/99 → 09/03		- ABS; → 06/03; für Linkslenker		03.7760-5102.4 300140	ATE Ø 10" pneumatisch	
				→ 06/03; + ABS; für Linkslenker		03.7863-2002.4 300126	ATE Ø 10" pneumatisch	













	kW					! #		
RENAULT - SCÉNIC I Großraumlimousine (JA0/1_, FA0_) 08/99→07/10								
 Bremskraftverstärker								
1.6 BiFuel	75	03/01→08/03		- ABS; → 06/03; für Linkslenker			03.7760-5102.4 300140	ATE Ø 10" pneumatisch
1.8 16V	85	01/01→08/03		→ 06/03; + ABS; für Linkslenker			03.7863-2002.4 300126	ATE Ø 10" pneumatisch
1.9 dCi	75	09/99→08/03						
1.9 dCi RX4	74 - 75	11/00→08/03						
2.0 16V	103	09/99→08/03						
2.0 16V RX4	102	06/00→08/03						
1.6 BiFuel	79	09/99→04/01		- ABS; für Linkslenker			03.7760-5102.4 300140	ATE Ø 10" pneumatisch
1.8 4x4	85	07/00→04/01		+ ABS; für Linkslenker			03.7863-2002.4 300126	ATE Ø 10" pneumatisch
1.9 D	47	09/99→03/01		+ ABS; für Linkslenker			03.7863-2002.4 300126	ATE Ø 10" pneumatisch
1.9 dTi	72	09/99→08/03		- ABS; → 06/03; für Linkslenker			03.7760-5102.4 300140	ATE Ø 10" pneumatisch
2.0 16V	102	07/00→08/03						
1.9 dTi	59	02/01→08/03		→ 06/03; + ABS; für Linkslenker			03.7863-2002.4 300126	ATE Ø 10" pneumatisch
 Hauptbremszylinder								
1.4 16V	70	09/99→08/03		→ 06/03; - ABS; für Linkslenker			03.2123-1551.3 010512	Ø 23,8
1.6	75 - 79	09/99→09/03		→ 06/03; + ABS / - ESP; für Linkslenker			03.2123-2146.3 010572	Ø 23,8
1.6 BiFuel	75	03/01→08/03		→ 06/03; + ABS / + ESP; für Linkslenker			03.2123-2621.3 010701	ATE Ø 23,8
1.8 16V	85	01/01→08/03						
1.9 dCi	75	09/99→08/03						
1.9 dCi RX4	74 - 75	11/00→08/03						
2.0 16V	102 - 103	09/99→08/03						
2.0 16V RX4	102	06/00→08/03						
1.6 BiFuel	79	09/99→04/01		für Linkslenker; - ABS			03.2123-1551.3 010512	Ø 23,8
1.8 4x4	85	07/00→04/01		+ ABS / - ESP; für Linkslenker			03.2123-2146.3 010572	Ø 23,8
				+ ABS / + ESP; für Linkslenker			03.2123-2621.3 010701	ATE Ø 23,8
1.9 D	47	09/99→03/01		+ ABS / - ESP; für Linkslenker			03.2123-2146.3 010572	Ø 23,8
				+ ABS / + ESP; für Linkslenker			03.2123-2621.3 010701	ATE Ø 23,8
1.9 dTi	72	09/99→08/03		→ 06/03; - ABS; für Linkslenker			03.2123-1551.3 010512	Ø 23,8
				→ 06/03; + ABS; für Linkslenker			03.2123-2146.3 010572	Ø 23,8
1.9 dTi	59	02/01→08/03		→ 06/03; + ABS / - ESP; für Linkslenker			03.2123-2146.3 010572	Ø 23,8
				→ 06/03; + ABS / + ESP; für Linkslenker			03.2123-2621.3 010701	ATE Ø 23,8
RENAULT - SCÉNIC II (JM0/1_) 06/03→07/10								
 Hauptbremszylinder								
1.4	72	06/03→11/08					24.2123-1760.3 010779	TRW Ø 23,8
1.5 dCi	60 - 78	06/03→11/08					24.4123-1721.3 011052	BOS Ø 23,8 ohne Bremsflüssigkeitsbehälter
1.6	77 - 83	06/03→11/08						
1.6 BiFuel	83	08/03→05/06						
1.6 Hi-Flex	81	03/05→07/10						
1.9 D	85	06/06→11/08						
1.9 dCi	72 - 96	06/03→11/08						
1.9 dCi 130	97	10/05→12/09						
2.0 16V Turbo	120	05/04→11/08						
2.0 dCi	110	09/05→11/08						
1.6 16V	82	10/05→11/08		01/07→			24.2123-1760.3 010779	TRW Ø 23,8
							24.4123-1721.3 011052	BOS Ø 23,8 ohne Bremsflüssigkeitsbehälter
2.0	99 - 101	06/03→06/09		→ 03/09			24.2123-1760.3 010779	TRW Ø 23,8
							24.4123-1721.3 011052	BOS Ø 23,8 ohne Bremsflüssigkeitsbehälter
RENAULT - SCÉNIC III (JZ0/1_) 12/08→09/16								
 Hauptbremszylinder								
1.2 TCe	85 - 96	04/12→09/16					24.4123-1715.3 010980	TRW Ø 23,8
1.4 16V	96	02/09→09/16						
1.5 dCi	63 - 81	04/09→09/16						
1.6 16V	81	02/09→09/16						
1.6 16V Bifuel	79	04/12→12/13						
1.6 dCi	96	04/11→09/16						
1.9 dCi	96	02/09→09/16						
2.0 16V	101	12/08→09/16						
2.0 dCi	118	04/09→09/16						
1.2 TCe	97	01/13→09/16		03/13→			24.4123-1715.3 010980	TRW Ø 23,8
1.5 dCi	78	02/09→09/16		04/09→			24.4123-1715.3 010980	TRW Ø 23,8
→								















	kw			 	! #		
RENAULT - SCÉNIC III (JZ0/1_) 12/08→09/16							
 Hauptbremszylinder							
2.0 16V 2.0 dCi	103 110	02/09→09/16 02/09→09/16		04/09→		24.4123-1715.3 010980	TRW Ø 23,8
1.6 16V Bifuel 1.6 E85	81 81	02/09→09/16 02/09→09/16		06/09→		24.4123-1715.3 010980	TRW Ø 23,8
RENAULT - SCÉNIC III VAN (JZ0/1_) 12/08→09/16							
 Hauptbremszylinder							
1.4 TCe 1.5 dCi	96 70 - 81	01/13→09/16 04/09→09/16				24.4123-1715.3 010980	TRW Ø 23,8
1.6 dCi 1.6 VVT 1.9 dCi	96 81 96	01/13→09/16 01/13→09/16 01/13→09/16					
RENAULT - THALIA I (LB_) 02/98→							
 Bremskraftverstärker							
1.2 16V 1.4 1.4 16V 1.5 dCi	55 55 72 47 - 62	04/02→ 08/00→ 08/00→ 06/01→				03.7750-1332.4 300155	ATE Ø 9" pneumatisch
1.6 1.6 16V 1.9 D	82 79 48	01/04→12/08 07/00→02/09 02/98→05/01					
 Hauptbremszylinder							
1.2 16V 1.4 1.4 16V 1.5 dCi	55 55 72 47 - 62	04/02→ 08/00→ 08/00→ 06/01→		- ABS + ABS		03.2120-2031.3 010106 03.2120-4461.3 010571	ATE Ø 20,6 ATE Ø 20,6
1.4 1.6	72 82	05/00→02/09 01/04→12/08		- ABS - ABS; 04/08→ + ABS		03.2120-2031.3 010106 03.2120-2031.3 010106 03.2120-4461.3 010571	ATE Ø 20,6 ATE Ø 20,6 ATE Ø 20,6
RENAULT - THALIA II (LU_) 09/08→							
 Hauptbremszylinder							
1.2 16V 1.2 LPG 1.4 1.5 dCi	55 55 55 47 - 66	09/08→06/14 01/10→12/13 09/08→06/14 09/08→		- ABS		03.2120-2031.3 010106	ATE Ø 20,6
1.4 1.6 16V	72 77 - 79	01/09→12/11 09/08→		für Linkslenker; + ABS + ABS		03.2120-4461.3 010571 03.2120-4461.3 010571	ATE Ø 20,6 ATE Ø 20,6
RENAULT - THALIA III (L8_) 12/13→							
 Hauptbremszylinder							
0.9 TCe 1.2 16V 1.2 LPG 1.5 dCi	66 55 55 55 - 70	06/14→ 12/13→ 03/14→ 12/13→		für Linkslenker; - ABS für Linkslenker; + ABS		24.4120-1714.3 011110 24.4120-1771.3 011076	Ø 20,6 ohne Bremsflüssigkeitsbehälter Ø 20,6 ohne Bremsflüssigkeitsbehälter
1.0 SCe	54	01/17→11/19		für Linkslenker		24.4120-1771.3 011076	Ø 20,6 ohne Bremsflüssigkeitsbehälter
RENAULT - TRAFIC II Bus (JL) 03/01→							
 Hauptbremszylinder							
1.9 dCi	59	04/01→07/03		für Linkslenker; - ESP für Rechtslenker; - ESP		24.2120-1738.3 010759 24.2125-1731.3 010826	TRW Ø 20,6 TRW Ø 25,4
1.9 dCi	75	01/12→12/18		für Linkslenker; - ESP für Rechtslenker; - ESP		24.2120-1740.3 010764 24.2125-1731.3 010826	TRW Ø 20,6 TRW Ø 25,4
1.9 dCi 100	74	03/01→10/06		→ 09/03; für Linkslenker; - ESP 10/03→; für Linkslenker; - ESP 10/03→; für Rechtslenker; - ESP		24.2120-1738.3 010759 24.2120-1740.3 010764 24.2125-1731.3 010826	TRW Ø 20,6 TRW Ø 20,6 TRW Ø 25,4
1.9 dCi 80	60	03/01→10/06		→ 09/03; für Linkslenker; - ESP 10/03→; für Linkslenker; - ESP für Rechtslenker; - ESP		24.2120-1738.3 010759 24.2120-1740.3 010764 24.2125-1731.3 010826	TRW Ø 20,6 TRW Ø 20,6 TRW Ø 25,4
2.0 2.0 16V →	88 86	03/01→ 08/06→		→ 08/14; - ESP für Linkslenker; → 08/14; - ESP		24.2125-1731.3 010826 24.2120-1740.3 010764	TRW Ø 25,4 TRW Ø 20,6













	kw					! #		
RENAULT - TRAFIC II Bus (JL) 03/01→								
 Hauptbremszylinder								
2.0 16V	86	08/06→			für Rechtslenker; → 08/14; - ESP		24.2125-1731.3 010826	TRW Ø 25,4
2.0 dCi 115	84	08/06→			10/06→ 08/14; + ABS / - ESP		24.2120-1748.3 010894	TRW Ø 20,6
2.5 dCi 145	107	08/06→			10/06→ 08/14; + ABS / + ESP		24.2120-1753.3 010946	TRW Ø 20,6
2.0 dCi 90	66	08/06→			10/06→ 08/14; - ESP		24.2125-1731.3 010826	TRW Ø 25,4
2.5 dCi 115	84	02/08→			→ 08/14; + ABS / - ESP		24.2120-1748.3 010894	TRW Ø 20,6
					→ 08/14; + ABS / + ESP		24.2120-1753.3 010946	TRW Ø 20,6
2.5 dCi 135	99	05/03→10/06			- ESP		24.2125-1731.3 010826	TRW Ø 25,4
RENAULT - TRAFIC II Kasten (FL) 03/01→								
 Hauptbremszylinder								
1.9 dCi	59	04/01→07/03			für Linkslenker; - ESP		24.2120-1738.3 010759	TRW Ø 20,6
					für Rechtslenker; - ESP		24.2125-1731.3 010826	TRW Ø 25,4
1.9 dCi	75	03/01→			→ 09/03; für Linkslenker; - ESP		24.2120-1738.3 010759	TRW Ø 20,6
					10/03→ 08/14; für Linkslenker; - ESP		24.2120-1740.3 010764	TRW Ø 20,6
					für Rechtslenker; → 08/14; - ESP		24.2125-1731.3 010826	TRW Ø 25,4
1.9 dCi 100	74	03/01→10/06			→ 09/03; für Linkslenker; - ESP		24.2120-1738.3 010759	TRW Ø 20,6
					10/03→; für Linkslenker; - ESP		24.2120-1740.3 010764	TRW Ø 20,6
					10/03→; für Rechtslenker; - ESP		24.2125-1731.3 010826	TRW Ø 25,4
1.9 dCi 80	60	03/01→10/06			→ 09/03; für Linkslenker; - ESP		24.2120-1738.3 010759	TRW Ø 20,6
					10/03→; für Linkslenker; - ESP		24.2120-1740.3 010764	TRW Ø 20,6
					für Rechtslenker; - ESP		24.2125-1731.3 010826	TRW Ø 25,4
2.0	88	03/01→			→ 08/14; - ESP		24.2125-1731.3 010826	TRW Ø 25,4
2.5 dCi	84	08/07→						
2.0 16V	86	08/06→			für Linkslenker; → 08/14; - ESP		24.2120-1740.3 010764	TRW Ø 20,6
					für Rechtslenker; → 08/14; - ESP		24.2125-1731.3 010826	TRW Ø 25,4
2.0 dCi 115	84	08/06→			10/06→ 08/14; + ABS / - ESP		24.2120-1748.3 010894	TRW Ø 20,6
2.5 dCi 145	107	08/06→			10/06→ 08/14; + ABS / + ESP		24.2120-1753.3 010946	TRW Ø 20,6
2.0 dCi 90	66	08/06→			10/06→ 08/14; - ESP		24.2125-1731.3 010826	TRW Ø 25,4
2.5 dCi 135	99	05/03→10/06			- ESP		24.2125-1731.3 010826	TRW Ø 25,4
RENAULT - TRAFIC II Pritsche/Fahrgestell (EL) 03/01→								
 Hauptbremszylinder								
1.9 dCi	59	09/01→07/03			für Linkslenker; - ESP		24.2120-1738.3 010759	TRW Ø 20,6
					für Rechtslenker; - ESP		24.2125-1731.3 010826	TRW Ø 25,4
1.9 dCi 100	74	03/01→10/06			→ 09/03; für Linkslenker; - ESP		24.2120-1738.3 010759	TRW Ø 20,6
					10/03→; für Linkslenker; - ESP		24.2120-1740.3 010764	TRW Ø 20,6
					10/03→; für Rechtslenker; - ESP		24.2125-1731.3 010826	TRW Ø 25,4
1.9 dCi 80	60	03/01→10/06			→ 09/03; für Linkslenker; - ESP		24.2120-1738.3 010759	TRW Ø 20,6
					10/03→; für Linkslenker; - ESP		24.2120-1740.3 010764	TRW Ø 20,6
					für Rechtslenker; - ESP		24.2125-1731.3 010826	TRW Ø 25,4
2.0	88	03/01→10/06			- ESP		24.2125-1731.3 010826	TRW Ø 25,4
2.0 16V	86	08/06→			für Linkslenker; → 08/14; - ESP		24.2120-1740.3 010764	TRW Ø 20,6
					für Rechtslenker; → 08/14; - ESP		24.2125-1731.3 010826	TRW Ø 25,4
2.0 dCi 115	84	08/06→			10/06→ 08/14; + ABS / - ESP		24.2120-1748.3 010894	TRW Ø 20,6
2.5 dCi 145	107	08/06→			10/06→ 08/14; + ABS / + ESP		24.2120-1753.3 010946	TRW Ø 20,6
2.0 dCi 90	66	08/06→			10/06→ 08/14; - ESP		24.2125-1731.3 010826	TRW Ø 25,4
2.5 dCi	84	08/07→			→ 08/14; - ESP		24.2125-1731.3 010826	TRW Ø 25,4
2.5 dCi 135	99	03/01→10/06			05/03→; - ESP		24.2125-1731.3 010826	TRW Ø 25,4
RENAULT - TRAFIC Bus (T_, P_, V_) 03/89→03/01								
 Hauptbremszylinder								
2.5 D	55	05/89→03/01			11/97→; + ABS		24.2025-1706.3 010676	Ø 25,4
2.5 D 4x4	55	08/89→03/01			11/97→; - ABS		24.2025-1708.3 010692	Ø 25,4
RENAULT - TRAFIC Kasten (T_, P_, V_) 03/89→10/02								
 Hauptbremszylinder								
2.5 D	55	05/89→03/01			11/97→; + ABS		24.2025-1706.3 010676	Ø 25,4
2.5 D 4x4	55	05/89→03/01			11/97→; - ABS		24.2025-1708.3 010692	Ø 25,4







	kw			 	! #		
RENAULT - TWINGO I (C06_) 03/93→10/12							
 Hauptbremszylinder							
1.2	40 - 43	05/96→06/07		- ABS		24.2120-1706.3 010262	Ø 20,6
1.2 16V	44 - 55	01/01→06/07		+ ABS		24.2120-1723.3 010545	BDX Ø 20,6
1.2 LPG	43	09/00→06/07					
1.2 LPG	44	10/03→06/07		08/04→; - ABS		24.2120-1706.3 010262	Ø 20,6
				08/04→; + ABS		24.2120-1723.3 010545	BDX Ø 20,6
RENAULT - TWINGO I Kasten/Schrägheck (S06_) 03/93→06/12							
 Hauptbremszylinder							
1.2	43 - 55	05/96→06/12		- ABS		24.2120-1706.3 010262	Ø 20,6
				+ ABS		24.2120-1723.3 010545	BDX Ø 20,6
RENAULT - TWINGO II (CNO_) 03/07→							
 Bremskraftverstärker							
1.2	43	03/07→09/14		für Linkslenker; → 07/14; + ESP		03.7750-7332.4 300298	ATE Ø 9" pneumatisch
1.2 16V	55 - 56	03/07→		für Linkslenker; → 07/14; - ESP		03.7853-3902.4 300270	ATE Ø 9" pneumatisch
1.2 TCe 100	75	02/11→					
1.2 Turbo	74	03/07→09/14					
1.5 dCi	47 - 62	03/07→09/14					
1.5 dCi 75	55	10/10→					
1.5 dCi 90	63	10/10→					
1.6 RS	98	05/08→09/14		für Linkslenker; → 07/14		03.7750-8832.4 300299	ATE Ø 9" pneumatisch
 Hauptbremszylinder							
1.2	43	03/07→09/14		für Linkslenker; → 07/14; - ESP		03.2120-4581.3 010915	ATE Ø 20,6
1.2 16V	55 - 56	03/07→		für Linkslenker; → 07/14; + ESP		03.2120-4641.3 010932	ATE Ø 20,6
1.2 TCe 100	75	02/11→					
1.2 Turbo	74	03/07→09/14					
1.5 dCi	47 - 62	03/07→09/14					
1.5 dCi 75	55	10/10→					
1.5 dCi 90	63	10/10→					
1.6 RS	98	05/08→09/14		für Linkslenker; → 07/14		03.2123-2751.3 011014	ATE Ø 23,8
RENAULT - TWINGO II Kasten/Schrägheck (CNO_) 09/10→09/14							
 Bremskraftverstärker							
1.2	55	09/10→09/14		für Linkslenker; + ESP		03.7750-7332.4 300298	ATE Ø 9" pneumatisch
1.5 dCi	55	10/10→09/14		für Linkslenker; - ESP		03.7853-3902.4 300270	ATE Ø 9" pneumatisch
 Hauptbremszylinder							
1.2	55	09/10→09/14		für Linkslenker; - ESP		03.2120-4581.3 010915	ATE Ø 20,6
1.5 dCi	55	10/10→09/14		für Linkslenker; + ESP		03.2120-4641.3 010932	ATE Ø 20,6
RENAULT - TWINGO III (BCM_, BCA_) 09/14→							
 Hauptbremszylinder							
0.9 TCe 110	80	11/16→				24.4150-1071.3 011046	ATE Ø 20,6 ohne Bremsflüssigkeitsbehälter
0.9 TCe 90	66	09/14→					
0.9 TCe 90 LPG	66	08/18→					
0.9 TCe 95	68	03/19→					
1.0 S Ce 65	48	03/19→					
1.0 S Ce 70	51 - 52	09/14→					
1.0 S Ce 75	54	03/19→					
Z.E:	60	05/20→					
RENAULT - VEL SATIS (BJO_) 06/02→							
 Bremskraftverstärker							
2.0 16 V Turbo	125	04/04→		→ 10/05; für Linkslenker; für Fahrzeuge ohne autom. Distanzregelung		03.7858-2802.4 300303	ATE Ø 9 / 8" pneumatisch
2.0 16V Turbo	120	06/02→08/09					
2.0 Turbo	108	04/05→					
2.2 dCi	83 - 110	06/02→					
3.0 dCi	130	06/02→06/06					
3.5	170	10/04→					
3.5 V6	177	06/02→					
→							















	kW			 	! #		
RENAULT - VEL SATIS (BJ0_) 06/02→							
Pedalwegsensord, Bremspedal							
2.0 16 V Turbo	125	04/04→		→ 10/05; für Fahrzeuge mit autom. Distanzregelung		03.0655-0005.2 370005	ATE
2.0 16V Turbo	120	06/02→08/09					
2.0 Turbo	108	04/05→					
2.2 dCi	83 - 110	06/02→					
3.0 dCi	130	06/02→06/06					
3.5	170	10/04→					
3.5 V6	177	06/02→					
 Hauptbremszylinder							
2.0 16 V Turbo	125	04/04→		→ 03/05		03.4125-0014.3 010794	ATE Ø 25,4
2.2 dCi	83 - 102	04/04→		04/05→ 12/09		03.4155-0043.3 010795	ATE Ø 25,4
3.5 V6	177	06/02→					
2.0 16V Turbo	120	06/02→08/09		→ 03/05		03.4125-0014.3 010794	ATE Ø 25,4
2.2 dCi	110	06/02→08/09		04/05→		03.4155-0043.3 010795	ATE Ø 25,4
3.0 dCi	130	06/02→06/06					
2.0 dCi	110 - 127	08/05→		→ 12/09		03.4155-0043.3 010795	ATE Ø 25,4
2.0 Turbo	108	04/05→					
3.0 dCi	133	06/06→08/09				03.4155-0043.3 010795	ATE Ø 25,4
3.5	170	10/04→		→ 03/05		03.4125-0014.3 010794	ATE Ø 25,4
				→ 12/09		03.4155-0043.3 010795	ATE Ø 25,4
RENAULT - WIND (E4M_) 07/10→							
 Bremskraftverstärker							
1.2	74	07/10→		für Linkslenker; → 09/13		03.7750-8832.4 300299	ATE Ø 9" pneumatisch
1.2 TCe 100	75	02/11→					
1.6	98	07/10→					
 Hauptbremszylinder							
1.2	74	07/10→		für Linkslenker; → 09/13		03.2123-2751.3 011014	ATE Ø 23,8
1.2 TCe 100	75	02/11→					
1.6	98	07/10→					
SAAB - 9-3 (YS3D) 02/98→08/03							
 Bremskraftverstärker							
2.0 i	96	02/98→09/02		01/01→; für Linkslenker		03.7750-2932.4 300175	ATE Ø 9" pneumatisch
2.0 SE Turbo	147	02/98→09/02					
2.0 Turbo	113 - 151	02/98→09/02					
2.2 TiD	92	11/00→09/02					
2.3 i	110	02/98→09/02					
2.0 Turbo	110	03/99→09/02		für Linkslenker		03.7750-2932.4 300175	ATE Ø 9" pneumatisch
 Hauptbremszylinder							
2.0 i	96	02/98→09/02		→ 12/00; für Linkslenker		03.2123-1121.3 010176	Ø 23,8
2.0 SE Turbo	147	02/98→09/02					
2.0 Turbo	113 - 151	02/98→09/02		01/01→		03.2123-1626.3 010727	ATE Ø 23,8
2.2 TiD	92	11/00→09/02					
2.3 i	110	02/98→09/02					
2.0 Turbo	110	03/99→09/02				03.2123-1626.3 010727	ATE Ø 23,8
2.2 TiD	85	02/98→11/00		für Linkslenker		03.2123-1121.3 010176	Ø 23,8
SAAB - 9-3 (YS3F, E79, D79, D75) 09/02→02/15							
 Hauptbremszylinder							
1	110	09/02→02/15		für Linkslenker; → 06/12		24.2125-1732.3 010827	TRW Ø 25,4
8t	110	09/02→02/15					
8t BioPower	110	01/07→02/15					
1.9 TiD	88 - 110	09/04→02/15					
1.9 TTiD	96 - 132	12/07→02/15					
2.0 t	120 - 177	09/02→02/15					
2.0 t BioPower	129 - 154	09/02→02/15					
2.0 t Bio Power	120 - 162	01/07→02/15					
2.0 t BioPower XWD	120 - 162	01/08→02/15					
2.0 Turbo Performance	185	04/04→02/15					
2.0 Turbo XWD	154	01/08→02/15					
2.0 t XWD	120 - 177	01/07→02/15					
→							









	kw					! #		
SAAB - 9-3 (YS3F, E79, D79, D75) 09/02→02/15								
 Hauptbremszylinder								
2.2 TiD	92	09/02→02/15			für Linkslenker; → 06/12		24.2125-1732.3 010827	TRW Ø 25,4
1.8 i	90	01/04→02/15			03/04→; für Linkslenker; → 06/12		24.2125-1732.3 010827	TRW Ø 25,4
2.0 T16	143	06/06→02/15			für Linkslenker		24.2125-1732.3 010827	TRW Ø 25,4
2.8 Turbo V6	184	03/05→02/15			→ 12/05; für Linkslenker		24.2125-1732.3 010827	TRW Ø 25,4
SAAB - 9-3 Cabriolet (YS3D) 02/98→08/03								
 Bremskraftverstärker								
2.0 i	96	02/98→08/03			09/00→ 07/03; für Linkslenker		03.7750-2932.4 300175	ATE Ø 9" pneumatisch
2.0 Turbo	113 - 151	02/98→08/03						
2.3 i	110	02/98→08/03						
2.3 Turbo	165	10/99→08/03						
2.0 SE Turbo	147	02/98→08/03			01/01→ 07/03; für Linkslenker		03.7750-2932.4 300175	ATE Ø 9" pneumatisch
2.0 Turbo	110	01/01→08/03			→ 07/03; für Linkslenker		03.7750-2932.4 300175	ATE Ø 9" pneumatisch
2.3	169	09/99→01/02			09/00→; für Linkslenker		03.7750-2932.4 300175	ATE Ø 9" pneumatisch
 Hauptbremszylinder								
2.0 i	96	02/98→08/03			→ 08/00; für Linkslenker		03.2123-1121.3 010176	Ø 23,8
2.0 Turbo	113 - 151	02/98→08/03			09/00→ 07/03		03.2123-1626.3 010727	ATE Ø 23,8
2.3 i	110	02/98→08/03						
2.3 Turbo	165	10/99→08/03						
2.0 SE Turbo	147	02/98→08/03			→ 08/00; für Linkslenker		03.2123-1121.3 010176	Ø 23,8
					01/01→ 07/03		03.2123-1626.3 010727	ATE Ø 23,8
2.0 Turbo	110	01/01→08/03			→ 07/03		03.2123-1626.3 010727	ATE Ø 23,8
2.3	169	09/99→01/02			10/99→ 08/00; für Linkslenker		03.2123-1121.3 010176	Ø 23,8
					09/00→		03.2123-1626.3 010727	ATE Ø 23,8
SAAB - 9-3 Cabriolet (YS3F) 08/03→02/15								
 Hauptbremszylinder								
1 8t	110	08/03→02/15			→ 06/12; für Linkslenker		24.2125-1732.3 010827	TRW Ø 25,4
8t BioPower	110	08/03→02/15						
1.8 i	90	01/04→02/15						
1.9 TiD	88 - 110	09/04→02/15						
1.9 TTiD	96 - 132	12/07→02/15						
2.0 t	120 - 162	08/03→02/15						
2.0 t BioPower	120 - 162	01/07→02/15						
2.0 Turbo Performance	185	04/04→02/15						
2.0	130 - 143	09/04→09/07			für Linkslenker		24.2125-1732.3 010827	TRW Ø 25,4
2.0 t BioPower	147	06/07→02/15			07/07→ 06/12; für Linkslenker		24.2125-1732.3 010827	TRW Ø 25,4
2.0 T BioPower	145	06/07→02/15						
SAAB - 9-3 Kombi (E50) 03/05→02/15								
 Hauptbremszylinder								
1.8 i	90	03/05→02/15			→ 06/12; für Linkslenker		24.2125-1732.3 010827	TRW Ø 25,4
1.8 t	110	03/05→02/15						
1.8t 2.0	110	03/05→02/15						
1.9 TiD	88 - 110	03/05→02/15						
1.9 TTiD	96 - 132	12/07→02/15						
2.0 t	110 - 177	03/05→02/15						
2.0 T16	143	04/06→02/15						
2.0 t BioPower	110 - 162	01/07→02/15						
2.0 t Bio Power	147	02/09→02/15						
2.0 t BioPower XWD	120 - 162	01/07→02/15						
2.0 t Bio Power XWD	154	06/08→02/15						
2.0 t XWD	120 - 177	01/07→02/15						
2.0 t XWD	154	06/08→02/15			07/08→ 06/12; für Linkslenker		24.2125-1732.3 010827	TRW Ø 25,4
SAAB - 9-3X (YS3) 02/09→02/15								
 Hauptbremszylinder								
1.9 TTiD AWD	132	02/09→12/12			03/09→ 06/12; für Linkslenker		24.2125-1732.3 010827	TRW Ø 25,4











	kw					! #		
SAAB - 9-3X (YS3) 02/09→02/15								
 Hauptbremszylinder								
2.0 t BioPower XWD 2.0 t XWD	154 154	02/09→12/12 02/09→02/15		03/09→06/12; für Linkslenker			24.2125-1732.3 010827	TRW Ø 25,4
2.0 T16 XWD 2.0 t BioPower XWD	162 162	01/11→02/15 01/11→12/12		→ 06/12; für Linkslenker			24.2125-1732.3 010827	TRW Ø 25,4
SAAB - 9-5 (YS3E) 09/97→12/09								
 Bremskraftverstärker								
1.9 TiD 2.0 t BioPower 2.2 TiD 2.3 t BioPower 2.3 Turbo	110 110 88 136 - 152 134 - 191	01/06→12/09 01/05→12/09 03/02→12/09 11/06→12/09 07/03→12/09		für Linkslenker			03.7745-3902.4 300129	ATE Ø 8 / 7" pneumatisch
2.0 t 2.3 t	110 - 136 125 - 136	09/97→12/09 09/97→12/09		→ 12/01; für Linkslenker 01/02→; für Linkslenker			03.7745-3003.4 300157 03.7745-3902.4 300129	ATE Ø 8 / 7" pneumatisch ATE Ø 8 / 7" pneumatisch
2.3 Turbo 3.0 TiD 3.0 V6t	184 130 147	09/01→12/09 07/01→08/05 01/98→08/05						
2.0 t Biopower 2.0 Turbo SE 2.3 Turbo 2.3 Turbo	132 141 169 224	09/05→12/09 10/98→07/00 10/99→09/01 06/03→08/05		06/06→; für Linkslenker für Linkslenker → 03/04; für Linkslenker			03.7745-3902.4 300129 03.7745-3003.4 300157 03.7745-3902.4 300129	ATE Ø 8 / 7" pneumatisch ATE Ø 8 / 7" pneumatisch ATE Ø 8 / 7" pneumatisch
SAAB - 9-5 (YS3G) 01/10→01/12								
 Bremskraftverstärker								
1.6 Turbo 2.0 t BioPower 2.0 t BioPower XWD 2.0 TiD 2.0 TTiD 2.0 TTiD XWD 2.0 Turbo 2.0 Turbo XWD 2.8 Turbo V6 XWD	132 162 162 118 140 140 162 162 221	05/10→01/12 05/10→01/12 05/10→01/12 05/10→01/12 05/10→01/12 05/10→01/12 05/10→01/12 05/10→01/12 05/10→01/12		für Linkslenker			03.7858-0732.4 300272	ATE Ø 9 / 8" pneumatisch
 Hauptbremszylinder								
1.6 Turbo 2.0 t BioPower 2.0 t BioPower XWD 2.0 TiD 2.0 TTiD 2.0 TTiD XWD 2.0 Turbo 2.0 Turbo XWD 2.8 Turbo V6 XWD	132 162 162 118 140 140 162 162 221	05/10→01/12 05/10→01/12 05/10→01/12 05/10→01/12 05/10→01/12 05/10→01/12 05/10→01/12 05/10→01/12 05/10→01/12		für Linkslenker für Rechtslenker			03.2125-0421.3 010934 24.4155-0201.3 011125	ATE Ø 25,4 ATE Ø 25,4 ohne Bremsflüssigkeitsbehälter
SAAB - 9-5 Kombi (YS3E) 10/98→12/09								
 Bremskraftverstärker								
1.9 TiD 2.0 t BioPower 2.2 TiD 2.3 t BioPower 2.3 Turbo	110 - 129 110 88 136 - 152 162 - 224	01/06→12/09 01/06→12/09 03/02→12/09 11/06→12/09 06/03→12/09		für Linkslenker			03.7745-3902.4 300129	ATE Ø 8 / 7" pneumatisch
2.0 t 2.3 t	110 125 - 136	10/98→12/09 10/98→12/09		→ 12/01; für Linkslenker 01/02→; für Linkslenker			03.7745-3003.4 300157 03.7745-3902.4 300129	ATE Ø 8 / 7" pneumatisch ATE Ø 8 / 7" pneumatisch
3.0 TiD 3.0 V6t 2.0 t 2.3 Turbo 2.0 t Biopower 2.3 t BioPower 2.3 Turbo	130 147 136 - 141 169 154 184	07/01→08/05 10/98→08/05 10/98→07/01 10/99→09/01 09/05→12/09 11/06→12/09 09/01→12/09		für Linkslenker 06/06→; für Linkslenker 01/07→; für Linkslenker 01/02→; für Linkslenker			03.7745-3003.4 300157 03.7745-3902.4 300129 03.7745-3902.4 300129 03.7745-3902.4 300129	ATE Ø 8 / 7" pneumatisch ATE Ø 8 / 7" pneumatisch ATE Ø 8 / 7" pneumatisch ATE Ø 8 / 7" pneumatisch
SEAT - ALHAMBRA (7V8, 7V9) 04/96→03/10								
 Bremskraftverstärker								
1.8 T 20V →	110	10/97→03/10		7M-W-507042→; → 05/00; für Linkslenker; + ABS			03.7755-1902.4 300138	ATE Ø 9 / 8" pneumatisch







	kw			 	! #								
SEAT - ALHAMBRA (7V8, 7V9) 04/96→03/10													
Bremskraftverstärker													
1.8 T 20V	110	10/97→03/10		06/00→; → 7M-3-515799; für Linkslenker; - ESP	03.7755-6302.4	300221	ATE Ø 9 / 8" pneumatisch						
				06/00→; für Rechtslenker; - ESP	03.7755-6302.4	300221	ATE Ø 9 / 8" pneumatisch						
				7M-3-515800→; für Linkslenker; - ESP	03.7755-6302.4	300221	ATE Ø 9 / 8" pneumatisch						
				05/98→; → 7M-W-507041; für Linkslenker; + ABS	03.7760-3002.4	300120	ATE Ø 10" pneumatisch						
				05/98→ 05/00; für Rechtslenker; + ABS	03.7760-3002.4	300120	ATE Ø 10" pneumatisch						
				06/00→; → 7M-3-515799; für Linkslenker; + ESP	03.7858-3302.4	300122	ATE Ø 9 / 8" pneumatisch						
				7M-3-515800→; für Linkslenker; + ESP	03.7858-9502.4	300205	ATE Ø 9 / 8" pneumatisch						
1.9 TDI 2.0 i	66 85	04/96→03/10 04/96→03/10		7M-W-507042→; → 05/00; für Linkslenker; + ABS	03.7755-1902.4	300138	ATE Ø 9 / 8" pneumatisch						
				06/00→; → 7M-3-515799; für Linkslenker; - ESP	03.7755-6302.4	300221	ATE Ø 9 / 8" pneumatisch						
				06/00→; für Rechtslenker; - ESP	03.7755-6302.4	300221	ATE Ø 9 / 8" pneumatisch						
				7M-3-515800→; für Linkslenker; - ESP	03.7755-6302.4	300221	ATE Ø 9 / 8" pneumatisch						
				→ 05/00; für Rechtslenker; + ABS	03.7760-3002.4	300120	ATE Ø 10" pneumatisch						
				→ 7M-W-507041; für Linkslenker; + ABS	03.7760-3002.4	300120	ATE Ø 10" pneumatisch						
				06/00→; → 7M-3-515799; für Linkslenker; + ESP	03.7858-3302.4	300122	ATE Ø 9 / 8" pneumatisch						
1.9 TDI	81	08/96→06/00		7M-W-507042→; → 05/00; für Linkslenker; + ABS	03.7755-1902.4	300138	ATE Ø 9 / 8" pneumatisch						
				10/97→ 05/00; für Rechtslenker; + ABS	03.7760-3002.4	300120	ATE Ø 10" pneumatisch						
1.9 TDI 2.8 V6	85 - 96 150	06/00→03/10 06/00→03/10		7M-3-515800→; für Linkslenker; - ESP	03.7755-6302.4	300221	ATE Ø 9 / 8" pneumatisch						
				für Rechtslenker; - ESP	03.7755-6302.4	300221	ATE Ø 9 / 8" pneumatisch						
				→ 7M-3-515799; für Linkslenker; - ESP	03.7755-6302.4	300221	ATE Ø 9 / 8" pneumatisch						
				→ 7M-3-515799; für Linkslenker; + ESP	03.7858-3302.4	300122	ATE Ø 9 / 8" pneumatisch						
				7M-3-515800→; für Linkslenker; + ESP	03.7858-9502.4	300205	ATE Ø 9 / 8" pneumatisch						
1.9 TDI 2.0 TDI	110 103	05/05→05/07 11/05→03/10		- ESP	03.7755-6302.4	300221	ATE Ø 9 / 8" pneumatisch						
				für Linkslenker; + ESP	03.7858-9502.4	300205	ATE Ø 9 / 8" pneumatisch						
1.9 TDI 4motion 2.8 V6 4motion	85 150	06/00→03/10 06/00→03/10		02/01→; → 7M-3-515799; für Linkslenker; - ESP	03.7755-6302.4	300221	ATE Ø 9 / 8" pneumatisch						
				02/01→; für Rechtslenker; - ESP	03.7755-6302.4	300221	ATE Ø 9 / 8" pneumatisch						
				7M-3-515800→; für Linkslenker; - ESP	03.7755-6302.4	300221	ATE Ø 9 / 8" pneumatisch						
				02/01→; → 7M-3-515799; für Linkslenker; + ESP	03.7858-3302.4	300122	ATE Ø 9 / 8" pneumatisch						
				7M-3-515800→; für Linkslenker; + ESP	03.7858-9502.4	300205	ATE Ø 9 / 8" pneumatisch						
Pedalwegsensoren, Bremspedal													
1.8 T 20V 1.9 TDI 1.9 TDI 4motion 2.0 i 2.8 V6 2.8 V6 4motion	110 66 - 96 85 85 150 150	10/97→03/10 04/96→03/10 06/00→03/10 04/96→03/10 06/00→03/10 06/00→03/10		7M-3-515800→; für Linkslenker; + ESP	03.0655-0006.2	370006	ATE						
			1.9 TDI 2.0 TDI	110 103	05/05→05/07 11/05→03/10		für Linkslenker; + ESP	03.0655-0006.2	370006	ATE			
						Hauptbremszylinder							
						1.8 T 20V	110	10/97→03/10		05/98→; → 7M-W-507041; + ABS	03.2123-1526.3	010477	Ø 23,8
										05/98→; → 7M-W-507041; - ABS	03.2123-1548.3	010478	Ø 23,8
										06/00→; → 7M-3-515799; - ESP	03.2125-0332.3	010952	Ø 25,4
	7M-W-507042→; → 05/00; + ABS	03.2125-0332.3	010952	Ø 25,4									
	7M-3-515800→; - ESP	03.2125-0332.3	010952	Ø 25,4									
	7M-W-507042→; → 05/00; - ABS	03.2125-8404.3	010583	ATE Ø 25,4									
	06/00→; → 7M-3-515799; + ESP	03.2125-9604.3	010581	Ø 25,4									
1.9 TDI 2.0 i	66 85	04/96→03/10 04/96→03/10		→ 7M-W-507041; + ABS	03.2123-1526.3	010477	Ø 23,8						
				→ 7M-W-507041; - ABS	03.2123-1548.3	010478	Ø 23,8						
				06/00→; → 7M-3-515799; - ESP	03.2125-0332.3	010952	Ø 25,4						
				7M-W-507042→; → 05/00; + ABS	03.2125-0332.3	010952	Ø 25,4						
				7M-3-515800→; - ESP	03.2125-0332.3	010952	Ø 25,4						
				7M-W-507042→; → 05/00; - ABS	03.2125-8404.3	010583	ATE Ø 25,4						
			06/00→; → 7M-3-515799; + ESP	03.2125-9604.3	010581	Ø 25,4							
→													

	kw					! #		
SEAT - ALHAMBRA (7V8, 7V9) 04/96→03/10								
 Hauptbremszylinder								
1.9 TDI	81	08/96→06/00		10/97→; → 7M-W-507041; + ABS		03.2123-1526.3	010477	Ø 23,8
				10/97→; → 7M-W-507041; - ABS		03.2123-1548.3	010478	Ø 23,8
				7M-W-507042→; → 05/00; + ABS		03.2125-0332.3	010952	Ø 25,4
				7M-W-507042→; → 05/00; - ABS		03.2125-8404.3	010583	ATE Ø 25,4
1.9 TDI	85 - 96	06/00→03/10		→ 7M-3-515799; - ESP		03.2125-0332.3	010952	Ø 25,4
2.8 V6	150	06/00→03/10		7M-3-515800→; - ESP		03.2125-0332.3	010952	Ø 25,4
				→ 7M-3-515799; + ESP		03.2125-9604.3	010581	Ø 25,4
1.9 TDI	110	05/05→05/07		- ESP		03.2125-0332.3	010952	Ø 25,4
2.0 TDI	103	11/05→03/10						
1.9 TDI 4motion	85	06/00→03/10		02/01→; → 7M-3-515799; - ESP		03.2125-0332.3	010952	Ø 25,4
2.8 V6 4motion	150	06/00→03/10		7M-3-515800→; - ESP		03.2125-0332.3	010952	Ø 25,4
				02/01→; → 7M-3-515799; + ESP		03.2125-9604.3	010581	Ø 25,4
Verschlusschraube, Hauptbremszylinder								
1.8 T 20V	110	10/97→03/10		05/98→; → 7M-W-507041; - ABS		03.3517-5100.1	390326	
1.9 TDI	66	04/96→03/10		→ 7M-W-507041; - ABS		03.3517-5100.1	390326	
2.0 i	85	04/96→03/10						
1.9 TDI	81	08/96→06/00		10/97→; → 7M-W-507041; - ABS		03.3517-5100.1	390326	
SEAT - ALHAMBRA (710, 711) 06/10→12/22								
 Bremskraftverstärker								
1.4 TSI	110	06/10→04/15		für Linkslenker		03.7873-4502.4	300284	ATE Ø 11" pneumatisch
1.8 TSI	118	11/12→04/15						
2.0 TDI	85 - 130	06/10→12/22						
2.0 TDI 4Drive	103	05/11→04/15						
2.0 TSI	147	11/10→05/12						
 Hauptbremszylinder								
1.4 TSI	110	06/10→12/22		für Linkslenker		03.4153-0186.3	010816	ATE Ø 23,8
1.8 TSI	118	11/12→04/15		für Rechtslenker		24.4153-0222.3	011047	ATE Ø 23,8 ohne Bremsflüssigkeitsbehälter
2.0 TDI	85 - 135	06/10→12/22						
2.0 TDi 4Drive	130	11/18→12/22						
2.0 TDI 4Drive	103 - 135	05/11→12/22						
2.0 TSI	147 - 162	11/10→12/22						
SEAT - ALHAMBRA VAN (7V8, 7V9) 03/96→03/10								
 Bremskraftverstärker								
1.9 TDI	96	11/02→11/08		7M-3-515800→; für Linkslenker; - ESP		03.7755-6302.4	300221	ATE Ø 9 / 8" pneumatisch
1.9 TDI 4motion	85	06/02→05/08		für Rechtslenker; - ESP		03.7755-6302.4	300221	ATE Ø 9 / 8" pneumatisch
				→ 7M-3-515799; für Linkslenker; - ESP		03.7755-6302.4	300221	ATE Ø 9 / 8" pneumatisch
				→ 7M-3-515799; für Linkslenker; + ESP		03.7858-3302.4	300122	ATE Ø 9 / 8" pneumatisch
				7M-3-515800→; für Linkslenker; + ESP		03.7858-9502.4	300205	ATE Ø 9 / 8" pneumatisch
Pedalwegsensor, Bremspedal								
1.9 TDI	96	11/02→11/08		7M-3-515800→; für Linkslenker; + ESP		03.0655-0006.2	370006	ATE
1.9 TDI 4motion	85	06/02→05/08						
 Hauptbremszylinder								
1.9 TDI	96	11/02→11/08		→ 7M-3-515799; - ESP		03.2125-0332.3	010952	Ø 25,4
1.9 TDI 4motion	85	06/02→05/08		7M-3-515800→; - ESP		03.2125-0332.3	010952	Ø 25,4
				→ 7M-3-515799; + ESP		03.2125-9604.3	010581	Ø 25,4
SEAT - ALHAMBRA VAN (711) 06/10→06/23								
 Hauptbremszylinder								
TDI	85 - 135	10/14→12/22		für Linkslenker		03.4153-0186.3	010816	ATE Ø 23,8
TDI 4Drive	110	05/15→12/22		für Rechtslenker		24.4153-0222.3	011047	ATE Ø 23,8 ohne Bremsflüssigkeitsbehälter
TSi	110	05/15→12/22						
SEAT - ALTEA (5P1) 03/04→12/15								
 Bremskraftverstärker								
1.2 TSI	77	04/10→07/15		05/10→; für Rechtslenker		03.7848-9802.4	300344	ATE Ø 7 / 8" pneumatisch
1.4 16V	63	05/06→05/11						
1.4 TSI	92	11/07→07/15		05/10→; für Linkslenker		03.7863-3232.4	300307	ATE Ø 10" pneumatisch
1.6 LPG	75	09/09→06/13				03.7863-3332.4	300308	ATE Ø 10" pneumatisch
→								









	kw			 	! #		
SEAT - ALTEA (5P1) 03/04→12/15							
Bremskraftverstärker							
1.6 TDI 1.8 TFSI 1.9 TDI	77 118 66	10/09→07/15 01/07→07/15 04/04→12/10		→ 04/10; für Linkslenker; +PR 1AC / 1AT		03.7863-3232.4 300307	ATE Ø 10" pneumatisch
2.0 TDI 2.0 TDI 16V	77 103 - 125 103	11/05→11/10 03/04→07/15					
1.6 2.0 FSI 2.0 TDI 2.0 TFSI	75 110 100 147	03/04→03/10 05/04→03/09 03/04→05/09 04/06→05/09		+PR 1AC / 1AT; für Linkslenker		03.7863-3232.4 300307	ATE Ø 10" pneumatisch
1.6 Multifuel 1.6 TDI	75 66	11/10→05/11 11/10→07/15		für Rechtslenker für Linkslenker		03.7848-9802.4 300344 03.7863-3232.4 300307 03.7863-3332.4 300308	ATE Ø 7 / 8" pneumatisch ATE Ø 10" pneumatisch ATE Ø 10" pneumatisch
Hauptbremszylinder							
1.2 TSI 1.4 TSI 1.6 LPG 1.6 TDI 1.8 TFSI 1.9 TDI	77 92 75 77 118 66	04/10→07/15 11/07→07/15 09/09→06/13 10/09→07/15 01/07→07/15 04/04→12/10		→ 04/10; für Linkslenker		03.2122-2129.3 010799 24.2122-1788.3 011145	ATE Ø 22,2 FTE Ø 22,2 ohne Bremsflüssigkeitsbehälter
2.0 TDI 2.0 TDI 16V	77 103 - 125 103	11/05→11/10 03/04→07/15		05/10→; +PR 1AC / 1AT / 1AS; für Linkslenker 05/10→; +PR 1AC / 1AT / 1LJ; für Linkslenker → 04/10; für Rechtslenker		03.2122-2129.3 010799 03.2123-3449.3 010808 24.2122-1981.3 011024 24.4152-0132.3 011025	ATE Ø 22,2 ATE Ø 23,8 ATE Ø 22,2 ohne Bremsflüssigkeitsbehälter ATE Ø 22,2 ohne Bremsflüssigkeitsbehälter
1.4 16V	63	05/06→05/11		05/10→; +PR 1AC / 1AT / 1AS / 1ZD / 1LJ / 1LV; für Rechtslenker 05/10→; für Rechtslenker		24.4152-0132.3 011025 24.4153-0202.3 011027	ATE Ø 22,2 ohne Bremsflüssigkeitsbehälter ATE Ø 23,8 ohne Bremsflüssigkeitsbehälter
1.6	75	03/04→03/10		→ 04/10; für Linkslenker 05/10→; +PR 1AC / 1AT / 1AS; für Linkslenker 05/10→; +PR 1AC / 1AT / 1LJ; für Linkslenker → 04/10; für Rechtslenker 05/10→; +PR 1LJ / 1LV / 1AC / 1AT / 1AS / 1ZD; für Rechtslenker 05/10→; für Rechtslenker		03.2122-2129.3 010799 24.2122-1788.3 011145 03.2123-3449.3 010808 24.2122-1981.3 011024 24.4152-0132.3 011025 24.4153-0202.3 011027 24.4152-0132.3 011025	ATE Ø 22,2 FTE Ø 22,2 ohne Bremsflüssigkeitsbehälter ATE Ø 23,8 ATE Ø 22,2 ohne Bremsflüssigkeitsbehälter ATE Ø 22,2 ohne Bremsflüssigkeitsbehälter ATE Ø 23,8 ohne Bremsflüssigkeitsbehälter
1.6 Multifuel 1.6 TDI	75 66	11/10→05/11 11/10→07/15		für Linkslenker; +PR 1AC / 1AT / 1AS für Linkslenker; +PR 1AC / 1AT / 1LJ für Rechtslenker; +PR 1AC / 1AT / 1AS / 1ZD / 1LJ / 1LV für Rechtslenker		03.2122-2129.3 010799 03.2123-3449.3 010808 24.4152-0132.3 011025 24.4153-0202.3 011027	ATE Ø 22,2 ATE Ø 23,8 ATE Ø 22,2 ohne Bremsflüssigkeitsbehälter ATE Ø 23,8 ohne Bremsflüssigkeitsbehälter
2.0 FSI	110	05/04→03/09		für Linkslenker für Rechtslenker		03.2122-2129.3 010799 24.2122-1788.3 011145 24.2122-1981.3 011024 24.4152-0132.3 011025	ATE Ø 22,2 FTE Ø 22,2 ohne Bremsflüssigkeitsbehälter ATE Ø 22,2 ohne Bremsflüssigkeitsbehälter ATE Ø 22,2 ohne Bremsflüssigkeitsbehälter
→							

	kw			 	! #		
SEAT - ALTEA (5P1) 03/04→12/15							
 Hauptbremszylinder							
2.0 TDI 2.0 TFSI	100 147	03/04→05/09 04/06→05/09		für Linkslenker	03.2122-2129.3 010799 24.2122-1788.3 011145	ATE Ø 22,2 FTE Ø 22,2 ohne Bremsflüssigkeitsbehälter	
				für Rechtslenker	24.2122-1981.3 011024 24.4153-0202.3 011027	ATE Ø 22,2 ohne Bremsflüssigkeitsbehälter ATE Ø 23,8 ohne Bremsflüssigkeitsbehälter	
				für Rechtslenker; +PR 1AC / 1AT / 1AS / 1ZD / 1LJ / 1LV	24.4152-0132.3 011025	ATE Ø 22,2 ohne Bremsflüssigkeitsbehälter	
Drucksensor, Bremskraftverstärker							
1.2 TSI 1.4 16V 1.4 TSI 1.6 LPG 1.6 TDI 1.8 TFSI 1.9 TDI 2.0 TDI 2.0 TDI 16V	77 63 92 75 77 118 66 - 77 103 - 125 103	04/10→07/15 05/06→05/11 11/07→07/15 09/09→06/13 10/09→07/15 01/07→07/15 04/04→12/10 11/05→11/10 03/04→07/15		→ 04/10; +PR 1AS; für Linkslenker	03.0655-0101.2 370008	ATE	
1.6 2.0 FSI 2.0 TDI 2.0 TFSI	75 110 100 147	03/04→03/10 05/04→03/09 03/04→05/09 04/06→05/09		+PR 1AS; für Linkslenker	03.0655-0101.2 370008	ATE	
SEAT - ALTEA XL (5P5, 5P8) 10/06→12/15							
 Bremskraftverstärker							
1.2 TSI 1.4 TSI 1.6 1.6 LPG 1.6 Multifuel 1.6 TDI 1.8 TFSI 1.9 TDI 1.9 TDI 4x4 2.0 TDI 2.0 TDI 16V 2.0 TDI 4x4	77 92 75 75 75 77 118 66 - 77 77 103 103 103	04/10→07/15 11/07→07/15 10/06→11/10 09/09→06/13 10/06→11/10 10/09→07/15 01/07→07/15 10/06→12/10 06/09→12/10 10/06→11/10 10/06→07/15 06/07→11/10		05/10→; für Rechtslenker 05/10→; für Linkslenker → 04/10; +PR 1AC / 1AT; für Linkslenker	03.7848-9802.4 300344 03.7863-3232.4 300307 03.7863-3332.4 300308 03.7863-3232.4 300307	ATE Ø 7 / 8" pneumatisch ATE Ø 10" pneumatisch ATE Ø 10" pneumatisch ATE Ø 10" pneumatisch	
1.4 16V	63	10/06→06/13		05/10→; für Rechtslenker 05/10→; für Linkslenker 05/08→; +PR 1AC / 1AT; → 04/10; für Linkslenker	03.7848-9802.4 300344 03.7863-3232.4 300307 03.7863-3332.4 300308 03.7863-3232.4 300307	ATE Ø 7 / 8" pneumatisch ATE Ø 10" pneumatisch ATE Ø 10" pneumatisch ATE Ø 10" pneumatisch	
1.6 TDI 2.0 TDI 16V 4x4	66 103	11/10→07/15 10/10→07/15		für Rechtslenker für Linkslenker	03.7848-9802.4 300344 03.7863-3232.4 300307 03.7863-3332.4 300308	ATE Ø 7 / 8" pneumatisch ATE Ø 10" pneumatisch ATE Ø 10" pneumatisch	
2.0 FSI 2.0 TDI 2.0 TFSI 2.0 TFSI 4x4	110 100 147 147	10/06→03/09 11/06→03/09 10/06→05/09 06/07→05/09		+PR 1AC / 1AT; für Linkslenker	03.7863-3232.4 300307	ATE Ø 10" pneumatisch	
2.0 TDI 2.0 TDI 4x4	125 125	06/07→12/13 06/07→06/13		05/10→; für Rechtslenker +PR 1AC / 1AT; für Linkslenker	03.7848-9802.4 300344 03.7863-3232.4 300307	ATE Ø 7 / 8" pneumatisch ATE Ø 10" pneumatisch	
2.0 TFSI 2.0 TFSI 4x4	155 155	05/09→07/15 05/09→07/15		05/10→; für Rechtslenker für Linkslenker	03.7848-9802.4 300344 03.7863-3232.4 300307 03.7863-3332.4 300308	ATE Ø 7 / 8" pneumatisch ATE Ø 10" pneumatisch ATE Ø 10" pneumatisch	
 Hauptbremszylinder							
1.2 TSI 1.4 TSI 1.6 1.6 LPG 1.6 Multifuel 1.6 TDI 1.8 TFSI 1.9 TDI 2.0 TDI 2.0 TDI 16V 2.0 TDI 4x4 2.0 TFSI 2.0 TFSI 4x4 →	77 92 75 75 75 77 118 66 - 77 103 103 103 155 155	04/10→07/15 11/07→07/15 10/06→11/10 09/09→06/13 10/06→11/10 10/09→07/15 01/07→07/15 10/06→12/10 10/06→11/10 10/06→07/15 06/07→11/10 05/09→07/15 05/09→07/15		→ 04/10; für Linkslenker 05/10→; für Linkslenker; +PR 1AC / 1AT / 1AS 05/10→; +PR 1AC / 1AT / 1LJ; für Linkslenker → 04/10; für Rechtslenker	03.2122-2129.3 010799 24.2122-1788.3 011145 03.2122-2129.3 010799 03.2123-3449.3 010808 24.2122-1981.3 011024 24.4152-0132.3 011025	ATE Ø 22,2 FTE Ø 22,2 ohne Bremsflüssigkeitsbehälter ATE Ø 22,2 ATE Ø 23,8 ATE Ø 22,2 ohne Bremsflüssigkeitsbehälter ATE Ø 22,2 ohne Bremsflüssigkeitsbehälter	

	kw			 	! #			
SEAT - ALTEA XL (5P5, 5P8) 10/06→12/15								
Hauptbremszylinder								
1.2 TSI	77	04/10→07/15		05/10→; für Rechtslenker; +PR 1AC / 1AT / 1AS / 1ZD / 1LJ / 1LV		24.4152-0132.3	011025	ATE Ø 22,2 ohne Bremsflüssigkeitsbehälter
1.4 TSI	92	11/07→07/15						
1.6	75	10/06→11/10						
1.6 LPG	75	09/09→06/13		05/10→; für Rechtslenker		24.4153-0202.3	011027	ATE Ø 23,8 ohne Bremsflüssigkeitsbehälter
1.6 Multifuel	75	10/06→11/10						
1.6 TDI	77	10/09→07/15						
1.8 TFSI	118	01/07→07/15						
1.9 TDI	66 - 77	10/06→12/10						
2.0 TDI	103	10/06→11/10						
2.0 TDI 16V	103	10/06→07/15						
2.0 TDI 4x4	103	06/07→11/10						
2.0 TFSI	155	05/09→07/15						
2.0 TFSI 4x4	155	05/09→07/15						
1.4 16V	63	10/06→06/13		05/10→; für Linkslenker; +PR 1AC / 1AT / 1AS		03.2122-2129.3	010799	ATE Ø 22,2
				05/08→ 04/10; für Linkslenker		03.2122-2129.3	010799	ATE Ø 22,2
						24.2122-1788.3	011145	FTE Ø 22,2 ohne Bremsflüssigkeitsbehälter
				05/10→; +PR 1AC / 1AT / 1LJ; für Linkslenker		03.2123-3449.3	010808	ATE Ø 23,8
				05/08→ 04/10; für Rechtslenker		24.2122-1981.3	011024	ATE Ø 22,2 ohne Bremsflüssigkeitsbehälter
						24.4152-0132.3	011025	ATE Ø 22,2 ohne Bremsflüssigkeitsbehälter
				05/10→; für Rechtslenker; +PR 1AC / 1AT / 1AS / 1ZD / 1LJ / 1LV		24.4152-0132.3	011025	ATE Ø 22,2 ohne Bremsflüssigkeitsbehälter
				05/10→; für Rechtslenker		24.4153-0202.3	011027	ATE Ø 23,8 ohne Bremsflüssigkeitsbehälter
1.6 TDI	66	11/10→07/15		für Linkslenker; +PR 1AC / 1AT / 1AS		03.2122-2129.3	010799	ATE Ø 22,2
2.0 TDI 16V 4x4	103	10/10→07/15		für Linkslenker; +PR 1AC / 1AT / 1LJ		03.2123-3449.3	010808	ATE Ø 23,8
				+PR 1AC / 1AT / 1AS / 1ZD / 1LJ / 1LV; für Rechtslenker		24.4152-0132.3	011025	ATE Ø 22,2 ohne Bremsflüssigkeitsbehälter
				für Rechtslenker		24.4153-0202.3	011027	ATE Ø 23,8 ohne Bremsflüssigkeitsbehälter
1.9 TDI 4x4	77	06/09→12/10		→ 04/10; für Linkslenker		03.2122-2129.3	010799	ATE Ø 22,2
						24.2122-1788.3	011145	FTE Ø 22,2 ohne Bremsflüssigkeitsbehälter
				05/10→; für Linkslenker; +PR 1AC / 1AT / 1AS		03.2122-2129.3	010799	ATE Ø 22,2
				→ 04/10; für Rechtslenker		24.2122-1981.3	011024	ATE Ø 22,2 ohne Bremsflüssigkeitsbehälter
						24.4152-0132.3	011025	ATE Ø 22,2 ohne Bremsflüssigkeitsbehälter
				05/10→; für Rechtslenker; +PR 1AC / 1AT / 1AS / 1ZD / 1LJ / 1LV		24.4152-0132.3	011025	ATE Ø 22,2 ohne Bremsflüssigkeitsbehälter
				05/10→; für Rechtslenker		24.4153-0202.3	011027	ATE Ø 23,8 ohne Bremsflüssigkeitsbehälter
2.0 FSI	110	10/06→03/09		für Linkslenker		03.2122-2129.3	010799	ATE Ø 22,2
2.0 TDI	100	11/06→03/09				24.2122-1788.3	011145	FTE Ø 22,2 ohne Bremsflüssigkeitsbehälter
2.0 TFSI 4x4	147	06/07→05/09						
				für Rechtslenker		24.2122-1981.3	011024	ATE Ø 22,2 ohne Bremsflüssigkeitsbehälter
						24.4153-0202.3	011027	ATE Ø 23,8 ohne Bremsflüssigkeitsbehälter
				+PR 1AC / 1AT / 1AS / 1ZD / 1LJ / 1LV; für Rechtslenker		24.4152-0132.3	011025	ATE Ø 22,2 ohne Bremsflüssigkeitsbehälter
2.0 TDI	125	06/07→12/13		für Linkslenker		03.2122-2129.3	010799	ATE Ø 22,2
2.0 TDI 4x4	125	06/07→06/13				24.2122-1788.3	011145	FTE Ø 22,2 ohne Bremsflüssigkeitsbehälter
				für Rechtslenker		24.2122-1981.3	011024	ATE Ø 22,2 ohne Bremsflüssigkeitsbehälter
						24.4152-0132.3	011025	ATE Ø 22,2 ohne Bremsflüssigkeitsbehälter
2.0 TFSI	147	10/06→05/09		für Linkslenker		03.2122-2129.3	010799	ATE Ø 22,2
						24.2122-1788.3	011145	FTE Ø 22,2 ohne Bremsflüssigkeitsbehälter
				für Rechtslenker		24.2122-1981.3	011024	ATE Ø 22,2 ohne Bremsflüssigkeitsbehälter
						24.4152-0132.3	011025	ATE Ø 22,2 ohne Bremsflüssigkeitsbehälter
				+PR 1AC / 1AT / 1AS / 1ZD / 1LJ / 1LV; für Rechtslenker		24.4152-0132.3	011025	ATE Ø 22,2 ohne Bremsflüssigkeitsbehälter



	kw					! #		
SEAT - ALTEA XL (5P5, 5P8) 10/06→12/15								
Drucksensor, Bremskraftverstärker								
1.2 TSI	77	04/10→07/15		→ 04/10; für Linkslenker; +PR 1AS		03.0655-0101.2	370008	ATE
1.4 TSI	92	11/07→07/15						
1.6	75	10/06→11/10						
1.6 LPG	75	09/09→06/13						
1.6 Multifuel	75	10/06→11/10						
1.6 TDI	77	10/09→07/15						
1.8 TFSI	118	01/07→07/15						
1.9 TDI	66 - 77	10/06→12/10						
1.9 TDI 4x4	77	06/09→12/10						
2.0 TDI	103	10/06→11/10						
2.0 TDI 16V	103	10/06→07/15						
2.0 TDI 4x4	103	06/07→11/10						
1.4 16V	63	10/06→06/13		05/08→; +PR 1AS; → 04/10; für Linkslenker		03.0655-0101.2	370008	ATE
2.0 FSI	110	10/06→03/09		+PR 1AS; für Linkslenker		03.0655-0101.2	370008	ATE
2.0 TDI	100 - 125	11/06→12/13						
2.0 TDI 4x4	125	06/07→06/13						
2.0 TFSI	147 - 155	10/06→07/15						
2.0 TFSI 4x4	147 - 155	06/07→07/15						
SEAT - ARONA (KJ7, KJP) 07/17→								
Hauptbremszylinder								
1.0 TGi	66	11/18→		für Linkslenker		24.2123-1782.3	011146	TRW Ø 23,8 ohne Bremsflüssigkeitsbehälter
1.0 TSI	70 - 85	07/17→						
1.5 TSI	110	07/17→						
1.6 SRE	81	07/17→						
1.6 TDI	70 - 85	07/17→						
SEAT - AROSA (6H1) 05/97→06/04								
Hauptbremszylinder								
1.0	37	05/97→06/04		für Linkslenker; - ABS		03.2120-3943.3	010532	ATE Ø 20,6
1.4	44	05/97→06/04						
1.4 16V	74	01/00→06/04		für Linkslenker; + ABS		03.2122-1344.3	010593	ATE Ø 22,2
1.4 TDI	55	01/00→06/04						
1.7 SDI	44	08/97→06/04		11/97→; für Linkslenker; - ABS		03.2120-3943.3	010532	ATE Ø 20,6
				11/97→; für Linkslenker; + ABS		03.2122-1344.3	010593	ATE Ø 22,2
SEAT - ATECA (KH7, KHP) 04/16→								
Hauptbremszylinder								
1.4 TSI 4Drive	110	06/16→		für Linkslenker		24.4123-1719.3	011017	TRW Ø 23,8 ohne Bremsflüssigkeitsbehälter
1.5 TSI 4Drive	110	07/18→						
2.0 TDI 4Drive	140	06/16→				24.4153-1522.3	011048	ATE Ø 23,8 ohne Bremsflüssigkeitsbehälter
2.0 TSI 4Drive	140	05/17→						
2.0 TDI 4Drive	110	04/16→		06/16→; für Linkslenker		24.4123-1719.3	011017	TRW Ø 23,8 ohne Bremsflüssigkeitsbehälter
				für Linkslenker		24.4153-1522.3	011048	ATE Ø 23,8 ohne Bremsflüssigkeitsbehälter
SEAT - CORDOBA (6K1, 6K2) 02/93→12/02								
Bremskraftverstärker								
1.0	51	06/01→08/02		für Linkslenker; - ABS		03.7750-6302.4	300161	ATE Ø 9" pneumatisch
				+ ABS; für Linkslenker; +PR 1KB		10.6350-3902.4	300213	ATE Ø 9" pneumatisch
				+ ABS; für Linkslenker; +PR 1KK / 1KM / 1KQ		10.6350-4002.4	300285	ATE Ø 9" pneumatisch
1.0 i	37	09/96→10/02		06/99→ 09/02; für Linkslenker; - ABS		03.7750-6302.4	300161	ATE Ø 9" pneumatisch
1.4 i	44	06/94→10/02						
1.4 i 16V	74	09/96→10/02		06/99→ 09/02; + ABS; für Linkslenker; +PR 1KB		10.6350-3902.4	300213	ATE Ø 9" pneumatisch
1.6 i	55 - 74	02/93→10/02						
1.9 TDI	66 - 81	08/96→10/02		06/99→ 09/02; + ABS; für Linkslenker; +PR 1KK / 1KM / 1KQ		10.6350-4002.4	300285	ATE Ø 9" pneumatisch
1.4 16V	55	05/00→10/02		→ 09/02; für Linkslenker; - ABS		03.7750-6302.4	300161	ATE Ø 9" pneumatisch
1.8 T 20V Cupra	115	07/00→10/02						
1.9 SDI	50	06/99→10/02		→ 09/02; für Linkslenker; + ABS; +PR 1KB		10.6350-3902.4	300213	ATE Ø 9" pneumatisch
→				→ 09/02; für Linkslenker; + ABS; +PR 1KK / 1KM / 1KQ		10.6350-4002.4	300285	ATE Ø 9" pneumatisch

SEAT - CORDOBA (6K1, 6K2) 02/93→12/02

Hauptbremszylinder

1.0	51	06/01→08/02		für Linkslenker; - ABS	03.2122-1042.3	010137	Ø 22,2
				für Linkslenker; + ABS	03.2123-1424.3	010637	ATE Ø 23,8
1.0 i	37	09/96→10/02		06/99→ 09/02; für Linkslenker; - ABS	03.2122-1042.3	010137	Ø 22,2
				06/99→ 09/02; für Linkslenker; + ABS	03.2123-1424.3	010637	ATE Ø 23,8
1.4 16V 1.8 T 20V Cupra 1.9 SDI	55	05/00→10/02		→ 09/02; für Linkslenker; - ABS	03.2122-1042.3	010137	Ø 22,2
	115	07/00→10/02		→ 09/02; für Linkslenker; + ABS	03.2123-1424.3	010637	ATE Ø 23,8
	50	06/99→10/02					
1.4 i 1.4 i 16V 1.6 i	44	06/94→10/02		→ 05/99; - ABS	03.2120-3943.3	010532	ATE Ø 20,6
	74	09/96→10/02		06/99→ 09/02; für Linkslenker; - ABS	03.2122-1042.3	010137	Ø 22,2
	74	07/96→10/02		06/99→ 09/02; für Linkslenker; + ABS	03.2123-1424.3	010637	ATE Ø 23,8
1.6 i	55	02/93→10/02		11/93→ 05/99; - ABS	03.2120-3943.3	010532	ATE Ø 20,6
				06/99→ 09/02; für Linkslenker; - ABS	03.2122-1042.3	010137	Ø 22,2
				06/99→ 09/02; für Linkslenker; + ABS	03.2123-1424.3	010637	ATE Ø 23,8
1.8 i	66	02/93→09/02		11/93→ 05/99; - ABS	03.2120-3943.3	010532	ATE Ø 20,6
1.9 TDI	66 - 81	08/96→10/02		06/99→ 09/02; für Linkslenker; - ABS	03.2122-1042.3	010137	Ø 22,2
				→ 05/99; - ABS	03.2122-1042.3	010137	Ø 22,2
				06/99→ 09/02; für Linkslenker; + ABS	03.2123-1424.3	010637	ATE Ø 23,8

Verschlusschraube, Hauptbremszylinder

1.4 i 1.4 i 16V 1.6 i 1.9 TDI	44	06/94→10/02		→ 05/99; - ABS	03.3517-0101.2	390322	
	74	09/96→10/02					
	74	07/96→10/02					
	66 - 81	08/96→10/02					
1.6 i 1.8 i	55	02/93→10/02		11/93→ 05/99; - ABS	03.3517-0101.2	390322	
	66	02/93→09/02					

SEAT - CORDOBA (6L2) 09/02→11/09

Bremskraftverstärker















1.2 1.4 TDI	47	10/02→06/06		für Linkslenker	03.7750-6302.4	300161	ATE Ø 9" pneumatisch	
	55	10/02→12/05						
1.2 12V 1.4 16V	51	05/06→11/09		→ 06/09; für Linkslenker	03.7750-6302.4	300161	ATE Ø 9" pneumatisch	
	63 - 74	10/02→11/09						
	1.4 TDI	51 - 59	05/05→11/09					
		74	04/03→11/09					
1.6 1.6 16V	77	11/06→11/09						
	96	10/02→11/09						
1.9 TDI	96	10/02→11/09						
1.4 16V	55	09/02→12/07		10/02→; für Linkslenker	03.7750-6302.4	300161	ATE Ø 9" pneumatisch	
1.9 SDI 1.9 TDI	47	09/02→11/09		10/02→ 06/09; für Linkslenker	03.7750-6302.4	300161	ATE Ø 9" pneumatisch	
	74	09/02→11/09						
2.0	85	09/02→11/09						













Hauptbremszylinder











1.2 1.4 TDI	47	10/02→06/06		+ ABS	24.2120-1734.3	010702	Ø 20,6	
	55	10/02→12/05		- ABS	24.2120-1736.3	010732	Ø 20,6	
1.2 12V 1.4 16V	51	05/06→11/09		→ 06/09; + ABS	24.2120-1734.3	010702	Ø 20,6	
	63 - 74	10/02→11/09		→ 06/09; - ABS	24.2120-1736.3	010732	Ø 20,6	
1.4 TDI	51 - 59	05/05→11/09						
			74	04/03→11/09				
	1.6 1.6 16V	77	11/06→11/09					
		96	10/02→11/09					
1.4 16V	55	09/02→12/07		10/02→; + ABS	24.2120-1734.3	010702	Ø 20,6	
				10/02→; - ABS	24.2120-1736.3	010732	Ø 20,6	
1.9 SDI	47	09/02→11/09		10/02→ 06/09; + ABS	24.2120-1734.3	010702	Ø 20,6	
1.9 TDI 2.0	74	09/02→11/09		10/02→ 06/09; - ABS	24.2120-1736.3	010732	Ø 20,6	
	85	09/02→11/09						













Bremskraftregler









1.2 1.4 TDI	47	10/02→06/06		- ABS	03.6583-0216.3	320247	ATE lastabhängig 8/3 4x
	55	10/02→12/05					
1.2 12V 1.4 16V	51	05/06→11/09		→ 06/09; - ABS	03.6583-0216.3	320247	ATE lastabhängig 8/3 4x
	63 - 74	10/02→11/09					
1.4 TDI	51 - 59	05/05→11/09					
			74	04/03→11/09			
1.6 1.6 16V	77	11/06→11/09					
	96	10/02→11/09					
1.9 TDI	96	10/02→11/09					
→							







	kw			 	! #		
SEAT - CORDOBA (6L2) 09/02→11/09							
 Bremskraftregler							
1.4 16V	55	09/02→12/07		10/02→; - ABS		03.6583-0216.3 320247	ATE lastabhängig 8/3 4x
1.9 SDI	47	09/02→11/09		10/02→ 06/09; - ABS		03.6583-0216.3 320247	ATE lastabhängig 8/3 4x
1.9 TDI	74	09/02→11/09					
2.0	85	09/02→11/09					
SEAT - CORDOBA Vario (6K5) 07/96→12/02							
 Bremskraftverstärker							
1.4	74	02/00→07/00		für Linkslenker; - ABS		03.7750-6302.4 300161	ATE Ø 9" pneumatisch
				für Linkslenker; + ABS; +PR 1KB		10.6350-3902.4 300213	ATE Ø 9" pneumatisch
				für Linkslenker; + ABS; +PR 1KK / 1KM / 1KQ		10.6350-4002.4 300285	ATE Ø 9" pneumatisch
1.4 16V	55	06/99→12/02		→ 09/02; für Linkslenker; - ABS		03.7750-6302.4 300161	ATE Ø 9" pneumatisch
1.9 SDI	50	06/99→12/02		→ 09/02; für Linkslenker; + ABS; +PR 1KB		10.6350-3902.4 300213	ATE Ø 9" pneumatisch
				→ 09/02; für Linkslenker; + ABS; +PR 1KK / 1KM / 1KQ		10.6350-4002.4 300285	ATE Ø 9" pneumatisch
1.4 i	44	09/96→12/02		06/99→ 09/02; für Linkslenker; - ABS		03.7750-6302.4 300161	ATE Ø 9" pneumatisch
1.6 i	55 - 74	09/96→12/02		06/99→ 09/02; für Linkslenker; + ABS; +PR 1KB		10.6350-3902.4 300213	ATE Ø 9" pneumatisch
1.9 TDI	66 - 81	08/96→12/02		06/99→ 09/02; für Linkslenker; + ABS; +PR 1KK / 1KM / 1KQ		10.6350-4002.4 300285	ATE Ø 9" pneumatisch
 Hauptbremszylinder							
1.4	74	02/00→07/00		- ABS		03.2120-3943.3 010532	ATE Ø 20,6
				für Linkslenker; - ABS		03.2122-1042.3 010137	Ø 22,2
				für Linkslenker; + ABS		03.2123-1424.3 010637	ATE Ø 23,8
1.4 16V	55	06/99→12/02		→ 09/02; für Linkslenker; - ABS		03.2122-1042.3 010137	Ø 22,2
1.9 SDI	50	06/99→12/02		→ 09/02; für Linkslenker; + ABS		03.2123-1424.3 010637	ATE Ø 23,8
1.4 i	44	09/96→12/02		→ 05/99; - ABS		03.2120-3943.3 010532	ATE Ø 20,6
1.6 i	55 - 74	09/96→12/02		06/99→ 09/02; für Linkslenker; - ABS		03.2122-1042.3 010137	Ø 22,2
				06/99→ 09/02; für Linkslenker; + ABS		03.2123-1424.3 010637	ATE Ø 23,8
1.9 TDI	66 - 81	08/96→12/02		06/99→ 09/02; für Linkslenker; - ABS		03.2122-1042.3 010137	Ø 22,2
				→ 05/99; - ABS		03.2122-1042.3 010137	Ø 22,2
				06/99→ 09/02; für Linkslenker; + ABS		03.2123-1424.3 010637	ATE Ø 23,8
Verschlusschraube, Hauptbremszylinder							
1.4	74	02/00→07/00		- ABS		03.3517-0101.2 390322	
1.4 i	44	09/96→12/02		→ 05/99; - ABS		03.3517-0101.2 390322	
1.6 i	55 - 74	09/96→12/02					
1.9 TDI	66 - 81	08/96→12/02					
SEAT - CORDOBA VARIO Kasten/Kombi (6K5) 08/00→12/02							
 Bremskraftverstärker							
1.9 TDI	81	08/00→12/02		→ 09/02; für Linkslenker; - ABS		03.7750-6302.4 300161	ATE Ø 9" pneumatisch
				→ 09/02; für Linkslenker; + ABS; +PR 1KB		10.6350-3902.4 300213	ATE Ø 9" pneumatisch
				→ 09/02; für Linkslenker; + ABS; +PR 1KK / 1KM / 1KQ		10.6350-4002.4 300285	ATE Ø 9" pneumatisch
 Hauptbremszylinder							
1.9 TDI	81	08/00→12/02		→ 09/02; für Linkslenker; - ABS		03.2122-1042.3 010137	Ø 22,2
				→ 09/02; für Linkslenker; + ABS		03.2123-1424.3 010637	ATE Ø 23,8
SEAT - EXEO (3R2) 12/08→05/13							
 Bremskraftverstärker							
1.6	75	03/09→09/10		04/09→		03.7858-4502.4 300202	ATE Ø 9 / 8" pneumatisch
1.8 T	110	12/08→05/10					
2.0 TDI	88 - 125	12/08→05/13					
2.0 TFSI	147	03/09→05/13					
1.8 TSI	88 - 118	05/10→05/13				03.7858-4502.4 300202	ATE Ø 9 / 8" pneumatisch
2.0 TFSI	155	05/10→05/13					
 Hauptbremszylinder							
1.6	75	03/09→09/10		04/09→		03.2125-0373.3 010810	ATE Ø 25,4
1.8 T	110	12/08→05/10					
→							







	kw					! #		
SEAT - EXEO (3R2) 12/08→05/13								
 Hauptbremszylinder								
2.0 TDI	88 - 125	12/08→05/13		04/09→			24.2125-1720.3 010688	TRW Ø 25,4
2.0 TFSI	147	03/09→05/13						
1.8 TSI	88 - 118	05/10→05/13					03.2125-0373.3 010810	ATE Ø 25,4
2.0 TFSI	155	05/10→05/13					24.2125-1720.3 010688	TRW Ø 25,4
SEAT - EXEO ST (3R5) 05/09→05/13								
 Bremskraftverstärker								
1.6	75	06/09→09/10					03.7858-4502.4 300202	ATE Ø 9 / 8" pneumatisch
1.8 T	110	06/09→05/10						
1.8 TSI	88 - 118	05/10→05/13						
2.0 TDI	88 - 125	05/09→05/13						
2.0 TFSI	147 - 155	06/09→05/13						
 Hauptbremszylinder								
1.6	75	06/09→09/10					03.2125-0373.3 010810	ATE Ø 25,4
1.8 T	110	06/09→05/10						
1.8 TSI	88 - 118	05/10→05/13					24.2125-1720.3 010688	TRW Ø 25,4
2.0 TDI	88 - 125	05/09→05/13						
2.0 TFSI	147 - 155	06/09→05/13						
SEAT - IBIZA II (6K1) 03/93→05/02								
 Bremskraftverstärker								
1.0 16V	51	10/99→05/02		→ 01/02; für Linkslenker; - ABS			03.7750-6302.4 300161	ATE Ø 9" pneumatisch
1.4 16V	55	05/00→02/02		→ 01/02; für Linkslenker; +PR 0G1 / 0G3 / 1KB; Schaltgetriebe			10.6350-3902.4 300213	ATE Ø 9" pneumatisch
1.8 T 20V Cupra	115	07/00→02/02						
1.8 T 20V Cupra R	132	07/00→02/02		→ 01/02; für Linkslenker; +PR 0G4; Schaltgetriebe			10.6350-4002.4 300285	ATE Ø 9" pneumatisch
1.9 SDI	50	08/99→02/02		→ 01/02; für Linkslenker; +PR 1KM / 1KK / 1KQ / 1ZK / 1KB; Automatikgetriebe			10.6350-4002.4 300285	ATE Ø 9" pneumatisch
1.0 i	37	09/96→02/02		08/99→ 01/02; für Linkslenker; - ABS			03.7750-6302.4 300161	ATE Ø 9" pneumatisch
1.4 i	44	09/93→02/02		08/99→ 01/02; für Linkslenker; +PR 0G1 / 0G3 / 1KB; Schaltgetriebe			10.6350-3902.4 300213	ATE Ø 9" pneumatisch
1.4 i 16V	74	06/97→02/02						
1.9 TDI	66 - 81	08/96→02/02		6K-TR069487→; → 07/99; für Linkslenker			10.6350-3902.4 300213	ATE Ø 9" pneumatisch
				08/99→ 01/02; für Linkslenker; +PR 0G4; Schaltgetriebe			10.6350-4002.4 300285	ATE Ø 9" pneumatisch
				08/99→ 01/02; für Linkslenker; +PR 1KM / 1KK / 1KQ / 1ZK / 1KB; Automatikgetriebe			10.6350-4002.4 300285	ATE Ø 9" pneumatisch
				6K-TR069487→; → 07/99; für Linkslenker; + ABS			10.6350-4002.4 300285	ATE Ø 9" pneumatisch
1.6 i	55 - 74	03/93→02/02		08/99→ 01/02; für Linkslenker; - ABS			03.7750-6302.4 300161	ATE Ø 9" pneumatisch
				→ 07/99; für Linkslenker; - ABS			03.7750-6302.4 300161	ATE Ø 9" pneumatisch
				08/99→ 01/02; für Linkslenker; +PR 0G1 / 0G3 / 1KB; Schaltgetriebe			10.6350-3902.4 300213	ATE Ø 9" pneumatisch
				6K-TR069487→; → 07/99; für Linkslenker			10.6350-3902.4 300213	ATE Ø 9" pneumatisch
				08/99→ 01/02; für Linkslenker; +PR 0G4; Schaltgetriebe			10.6350-4002.4 300285	ATE Ø 9" pneumatisch
				08/99→ 01/02; für Linkslenker; +PR 1KM / 1KK / 1KQ / 1ZK / 1KB; Automatikgetriebe			10.6350-4002.4 300285	ATE Ø 9" pneumatisch
				6K-TR069487→; → 07/99; für Linkslenker; + ABS			10.6350-4002.4 300285	ATE Ø 9" pneumatisch
 Hauptbremszylinder								
1.0 16V	51	10/99→05/02		→ 01/02; für Linkslenker; - ABS			03.2122-1042.3 010137	Ø 22,2
1.4 16V	55	05/00→02/02		→ 01/02; für Linkslenker; + ABS			03.2123-1424.3 010637	ATE Ø 23,8
1.8 T 20V Cupra	115	07/00→02/02						
1.8 T 20V Cupra R	132	07/00→02/02						
1.9 SDI	50	08/99→02/02						
1.0 i	37	09/96→02/02		→ 07/99; - ABS			03.2120-3943.3 010532	ATE Ø 20,6
1.4 i	44	09/93→02/02		08/99→ 01/02; für Linkslenker; - ABS			03.2122-1042.3 010137	Ø 22,2
1.6 i	55 - 74	03/93→02/02		08/99→ 01/02; für Linkslenker; + ABS			03.2123-1424.3 010637	ATE Ø 23,8
1.4 i 16V	74	06/97→02/02		08/99→ 01/02; für Linkslenker; - ABS			03.2122-1042.3 010137	Ø 22,2
→								

	kW			 	! #		
SEAT - IBIZA II (6K1) 03/93→05/02							
 Hauptbremszylinder							
1.4 i 16V	74	06/97→02/02		08/99→ 01/02; für Linkslenker; + ABS		03.2123-1424.3 010637	ATE Ø 23,8
1.9 TDI	66	08/96→02/02		08/99→ 01/02; für Linkslenker; - ABS		03.2122-1042.3 010137	Ø 22,2
				→ 07/99; - ABS		03.2122-1042.3 010137	Ø 22,2
				08/99→ 01/02; für Linkslenker; + ABS		03.2123-1424.3 010637	ATE Ø 23,8
1.9 TDI	81	02/97→02/02		03/97→ 07/99; - ABS		03.2122-1042.3 010137	Ø 22,2
				08/99→ 01/02; für Linkslenker; - ABS		03.2122-1042.3 010137	Ø 22,2
				08/99→ 01/02; für Linkslenker; + ABS		03.2123-1424.3 010637	ATE Ø 23,8
Verschlusschraube, Hauptbremszylinder							
1.0 i	37	09/96→02/02		→ 07/99; - ABS		03.3517-0101.2 390322	
1.4 i	44	09/93→02/02					
1.6 i	55 -	03/93→02/02					
	74						
1.9 TDI	66	08/96→02/02					
1.9 TDI	81	02/97→02/02		03/97→ 07/99; - ABS		03.3517-0101.2 390322	
SEAT - IBIZA III (6L1) 02/02→11/09							
 Hauptbremszylinder							
1.2	44 -	02/02→05/08		+ ABS		24.2120-1734.3 010702	Ø 20,6
	47			- ABS		24.2120-1736.3 010732	Ø 20,6
1.2 12V	51	05/06→11/09					
1.4 16V	55 -	02/02→11/09					
	74						
1.4 TDI	51 -	05/02→11/09					
	59						
1.6	74	02/03→11/09					
1.6 16V	77	11/06→11/09					
1.8 T Cupra R	132	01/04→02/08					
1.8 T FR	110	12/03→05/08					
1.9 SDI	47	02/02→12/05					
1.9 TDI	74 -	02/02→11/09					
	96						
1.9 TDI Cupra R	118	03/04→02/08					
1.9 TDI Joya Racer	112	07/03→06/04					
2.0	85	04/02→11/09					
 Bremskraftregler							
1.2	44 -	02/02→05/08		- ABS		03.6583-0216.3 320247	ATE lastabhängig 8/3 4x
	47						
1.2 12V	51	05/06→11/09					
1.4 16V	55 -	02/02→11/09					
	74						
1.4 TDI	51 -	05/02→11/09					
	59						
1.6	74	02/03→11/09					
1.6 16V	77	11/06→11/09					
1.8 T Cupra R	132	01/04→02/08					
1.8 T FR	110	12/03→05/08					
1.9 SDI	47	02/02→12/05					
1.9 TDI	74 -	02/02→11/09					
	96						
1.9 TDI Cupra R	118	03/04→02/08					
1.9 TDI Joya Racer	112	07/03→06/04					
2.0	85	04/02→11/09					
SEAT - IBIZA IV (6J5, 6P1) 03/08→12/17							
 Bremskraftregler							
1.0	55	05/15→06/17		- ABS		03.6583-0216.3 320247	ATE lastabhängig 8/3 4x
1.0 TSI	70 -	05/15→06/17					
	81						
1.2	44	07/09→05/11					
1.2 TDI	55	06/10→05/15					
1.2 TSI	63 -	09/10→06/17					
	81						
1.4 TDI	55 -	07/08→06/17					
	77						
1.6	81	07/15→06/17					
1.6 LPG	60	05/11→05/15					
1.9 TDI	66	07/08→06/10					
1.2	51	03/08→05/15		07/08→; - ABS		03.6583-0216.3 320247	ATE lastabhängig 8/3 4x
1.2 LPG	51	03/08→05/11					
1.4	63	03/08→05/15					
1.4 LPG	63	03/08→05/11					
1.6	77	05/08→03/12					
1.9 TDI	77	03/08→06/10					









	kW					! #		
SEAT - IBIZA IV Kasten/Schrägheck (6J1) 04/08→05/15								
 Bremskraftregler								
1.2 1.2 TDI	51 55	04/08→05/15 05/10→05/15		- ABS		03.6583-0216.3	320247	ATE lastabhängig 8/3 4x
SEAT - IBIZA IV SC (6J1, 6P5) 06/08→12/18								
 Bremskraftregler								
1.0 1.0 TSI	55 70 - 81	05/15→12/16 05/15→12/16		- ABS		03.6583-0216.3	320247	ATE lastabhängig 8/3 4x
1.2	44 - 51	07/08→05/15						
1.2 TDI	55	05/10→05/15						
1.2 TSI	63 - 81	09/10→12/16						
1.4	63	07/08→05/15						
1.4 LPG	63	07/08→05/11						
1.4 TDI	55 - 77	07/08→12/16						
1.6	77 - 81	07/08→12/16						
1.6 LPG	60	05/11→05/15						
1.9 TDI	66 - 77	06/08→06/10						
SEAT - IBIZA IV ST (6J8, 6P8) 03/10→07/16								
 Bremskraftregler								
1.0 1.0 TSI	55 70 - 81	05/15→07/16 05/15→07/16		- ABS		03.6583-0216.3	320247	ATE lastabhängig 8/3 4x
1.2	44 - 51	05/10→05/15						
1.2 TDI	55	04/10→05/15						
1.2 TSI	63 - 81	09/10→07/16						
1.4	63	03/10→05/15						
1.4 TDI	55 - 77	05/15→07/16						
1.6	77	02/12→05/15						
SEAT - IBIZA V (KJ1, KJG) 01/17→								
 Hauptbremszylinder								
1.0	48 - 55	01/17→		für Linkslenker; +PR 1ZE / 1ZQ		24.2123-1782.3	011146	TRW Ø 23,8 ohne Bremsflüssigkeitsbehälter
1.0 MPi	59	07/18→				24.4123-1719.3	011017	TRW Ø 23,8 ohne Bremsflüssigkeitsbehälter
1.0 TGI	66	11/17→						
1.0 TSI	70 - 85	01/17→						
1.5 TSI	110	07/17→						
1.6	81	05/17→						
1.6 TDI	59 - 85	09/17→						
SEAT - INCA (6K9) 11/95→11/03								
 Bremskraftverstärker								
1.4 16V	55	04/00→06/03		für Linkslenker; - ABS		03.7750-6302.4	300161	ATE Ø 9" pneumatisch
1.4 i	44	11/95→06/03						
1.6 i	55	06/97→09/00		für Linkslenker; + ABS		10.6350-4002.4	300285	ATE Ø 9" pneumatisch
1.7 D	42	09/96→06/03						
1.9 D	47	11/95→06/03						
1.9 SDI	47	11/95→06/03						
1.9 TDI	66	09/96→06/03						
 Hauptbremszylinder								
1.4 16V	55	04/00→06/03		- ABS		03.2122-1042.3	010137	Ø 22,2
				+ ABS		03.2123-1424.3	010637	ATE Ø 23,8
						03.2123-1484.3	010595	ATE Ø 23,8
1.4 i	44	11/95→06/03		für Linkslenker; - ABS		03.2122-1042.3	010137	Ø 22,2
1.6 i	55	06/97→09/00						
1.7 D	42	09/96→06/03		→ 9K-X-006000; für Rechtslenker; - ABS		03.2122-1042.3	010137	Ø 22,2
1.9 D	47	11/95→06/03		für Linkslenker; + ABS		03.2123-1424.3	010637	ATE Ø 23,8
1.9 SDI	47	11/95→06/03						
1.9 TDI	66	09/96→06/03		für Rechtslenker; + ABS		03.2123-1484.3	010595	ATE Ø 23,8
Verschlussschraube, Hauptbremszylinder								
1.4 16V	55	04/00→06/03		- ABS		03.3517-0101.2	390322	
1.4 i	44	11/95→06/03		für Linkslenker; - ABS		03.3517-0101.2	390322	
1.6 i	55	06/97→09/00		→ 9K-X-006000; für Rechtslenker; - ABS		03.3517-0101.2	390322	

	kw			 	! #		
SEAT - INCA (6K9) 11/95→11/03							
Verschlusschraube, Hauptbremszylinder							
1.7 D	42	09/96→06/03		für Linkslenker; - ABS		03.3517-0101.2	390322
1.9 D	47	11/95→06/03					
1.9 SDI	47	11/95→06/03		→ 9K-X-006000; für Rechtslenker; - ABS		03.3517-0101.2	390322
1.9 TDI	66	09/96→06/03					
SEAT - LEON (1M1) 11/99→06/06							
 Bremskraftverstärker							
1.4 16V	55	11/99→06/06		1M-1R023639→; → 07/05; für Linkslenker; + ESP		03.7860-0602.4	300141 ATE Ø 10" pneumatisch
1.6	74	11/99→06/06					
1.6 16 V	77	09/00→06/06		1M-1B018342→; → 07/05; für Linkslenker; + ESP		03.7860-0602.4	300141 ATE Ø 10" pneumatisch
1.8 20V	92	11/99→06/06					
1.8 20V T	132	11/99→06/06		→ 1M-1R023638; für Linkslenker; + ESP		03.7863-0402.4	300124 ATE Ø 10" pneumatisch
1.8 20V T 4	132	11/99→06/06					
1.8 T Cupra R	165	07/03→06/06		→ 1M-1B018341; für Linkslenker; + ESP		03.7863-0402.4	300124 ATE Ø 10" pneumatisch
1.9 SDI	50	11/99→06/06					
1.9 TDI	66	11/99→06/06					
	96						
1.9 TDI Syncro	110	05/02→06/06					
2.8 Cupra 4	150	02/01→06/06					
1.6	75	10/05→06/06		→ 1M-1B018341; für Linkslenker; + ESP		03.7863-0402.4	300124 ATE Ø 10" pneumatisch
				→ 1M-1R023638; für Linkslenker; + ESP		03.7863-0402.4	300124 ATE Ø 10" pneumatisch
1.8 T Cupra R	154	02/02→06/06		1M-1B018342→; → 07/05; für Linkslenker; + ESP		03.7860-0602.4	300141 ATE Ø 10" pneumatisch
				1M-1R023639→; → 07/05; für Linkslenker; + ESP		03.7860-0602.4	300141 ATE Ø 10" pneumatisch
				05/02→; → 1M-1B018341; + ESP; für Linkslenker		03.7863-0402.4	300124 ATE Ø 10" pneumatisch
				05/02→; → 1M-1R023638; + ESP; für Linkslenker		03.7863-0402.4	300124 ATE Ø 10" pneumatisch
1.9 TDI	74	10/05→06/06		1M-1B018342→; für Linkslenker; + ESP		03.7860-0602.4	300141 ATE Ø 10" pneumatisch
2.8	150	05/02→06/04		1M-1R023639→; für Linkslenker; + ESP		03.7860-0602.4	300141 ATE Ø 10" pneumatisch
				→ 1M-1B018341; für Linkslenker; + ESP		03.7863-0402.4	300124 ATE Ø 10" pneumatisch
				→ 1M-1R023638; für Linkslenker; + ESP		03.7863-0402.4	300124 ATE Ø 10" pneumatisch
1.9 TDI	110	09/00→06/06		1M-1B018342→; → 07/05; für Linkslenker; + ESP		03.7860-0602.4	300141 ATE Ø 10" pneumatisch
				1M-1R023639→; → 07/05; für Linkslenker; + ESP		03.7860-0602.4	300141 ATE Ø 10" pneumatisch
				02/01→; → 1M-1B018341; für Linkslenker; + ESP		03.7863-0402.4	300124 ATE Ø 10" pneumatisch
				02/01→; → 1M-1R023638; für Linkslenker; + ESP		03.7863-0402.4	300124 ATE Ø 10" pneumatisch
 Hauptbremszylinder							
1.4 16V	55	11/99→06/06		→ 08/00; für Linkslenker; + ESP		03.2123-2024.3	010597 ATE Ø 23,8
1.6	74	11/99→06/06		09/00→ 07/05; für Linkslenker; + ESP		03.2123-2715.3	010802 ATE Ø 23,8
1.8 20V	92	11/99→06/06		09/00→ 07/05; für Rechtslenker; + ESP		03.2123-2774.3	010803 ATE Ø 23,8
1.8 20V T	132	11/99→06/06					
1.9 SDI	50	11/99→06/06		→ 07/05; für Linkslenker; - ESP		24.2123-1709.3	010503 Ø 23,8
1.9 TDI	66	11/99→06/06					
1.6 16 V	77	09/00→06/06		→ 07/05; für Linkslenker; + ESP		03.2123-2715.3	010802 ATE Ø 23,8
1.8 T Cupra R	165	07/03→06/06		→ 07/05; + ESP; für Rechtslenker		03.2123-2774.3	010803 ATE Ø 23,8
1.9 TDI	96	05/03→06/06					
1.9 TDI Syncro	110	05/02→06/06		→ 07/05; für Linkslenker; - ESP		24.2123-1709.3	010503 Ø 23,8
2.8 Cupra 4	150	02/01→06/06					
1.8 20V T 4	132	11/99→06/06		→ 08/00; für Linkslenker; + ESP		03.2123-2024.3	010597 ATE Ø 23,8
				→ 07/05; für Linkslenker; + ESP		03.2123-2715.3	010802 ATE Ø 23,8
				→ 07/05; + ESP; für Rechtslenker		03.2123-2774.3	010803 ATE Ø 23,8
				→ 07/05; für Linkslenker; - ESP		24.2123-1709.3	010503 Ø 23,8
1.8 T Cupra R	154	02/02→06/06		05/02→ 07/05; für Linkslenker; + ESP		03.2123-2715.3	010802 ATE Ø 23,8
				05/02→ 07/05; + ESP; für Rechtslenker		03.2123-2774.3	010803 ATE Ø 23,8
				05/02→ 07/05; für Linkslenker; - ESP		24.2123-1709.3	010503 Ø 23,8
1.9 TDI	74	10/05→06/06		für Linkslenker; + ESP		03.2123-2715.3	010802 ATE Ø 23,8
2.8	150	05/02→06/04		für Rechtslenker; + ESP		03.2123-2774.3	010803 ATE Ø 23,8
				für Linkslenker; - ESP		24.2123-1709.3	010503 Ø 23,8
1.9 TDI	81	11/99→06/06		→ 08/00; für Linkslenker; + ESP		03.2123-2024.3	010597 ATE Ø 23,8
				→ 07/05; für Linkslenker; + ESP		03.2123-2715.3	010802 ATE Ø 23,8
				09/00→ 07/05; für Rechtslenker; + ESP		03.2123-2774.3	010803 ATE Ø 23,8
				→ 07/05; für Linkslenker; - ESP		24.2123-1709.3	010503 Ø 23,8
1.9 TDI	110	09/00→06/06		02/01→ 07/05; + ESP; für Linkslenker		03.2123-2715.3	010802 ATE Ø 23,8
				02/01→ 07/05; für Rechtslenker; + ESP		03.2123-2774.3	010803 ATE Ø 23,8
				02/01→ 07/05; für Linkslenker; - ESP		24.2123-1709.3	010503 Ø 23,8









	kw			 	! #		
SEAT - LEON (1P1) 05/05→12/13							
Bremskraftverstärker							
1.2 TSI 1.4 16V 1.4 TSI 1.6 LPG 1.6 TDI 1.8 TSI 2.0 Cupra R 2.0 TDI 2.0 TFSI	77 63 92 75 77 118 195 125 155	02/10→12/12 06/06→12/12 11/07→12/12 12/09→12/12 02/10→12/12 06/07→12/12 09/09→12/12 05/06→12/12 06/09→12/12	+PR 1AC / 1AT; → 10/12; für Rechtslenker → 05/10; +PR 1AC / 1AT; für Linkslenker; für Kolbendurchmesser [mm]: 22,2 06/10→; +PR 1AC / 1AT; → 10/12; für Linkslenker; für Kolbendurchmesser [mm]: 22,2 → 05/10; +PR 1AC / 1AT; für Linkslenker; für Kolbendurchmesser [mm]: 23,81 06/10→; +PR 1AC / 1AT; → 10/12; für Linkslenker; für Kolbendurchmesser [mm]: 23,81		03.7848-9802.4 03.7863-3232.4 03.7863-3232.4 03.7863-3332.4 03.7863-3332.4	300344 300307 300307 300308 300308	ATE Ø 7 / 8" pneumatisch ATE Ø 10" pneumatisch ATE Ø 10" pneumatisch ATE Ø 10" pneumatisch ATE Ø 10" pneumatisch
1.6 2.0 TDI 16V	75 103	07/05→12/12 07/05→12/12	08/05→; +PR 1AC / 1AT; → 10/12; für Rechtslenker 06/10→; +PR 1AC / 1AT; → 10/12; für Linkslenker; für Kolbendurchmesser [mm]: 22,2 08/05→ 05/10; +PR 1AC / 1AT; für Linkslenker; für Kolbendurchmesser [mm]: 22,2 06/10→; +PR 1AC / 1AT; → 10/12; für Linkslenker; für Kolbendurchmesser [mm]: 23,81 08/05→ 05/10; +PR 1AC / 1AT; für Linkslenker; für Kolbendurchmesser [mm]: 23,81		03.7848-9802.4 03.7863-3232.4 03.7863-3232.4 03.7863-3332.4 03.7863-3332.4	300344 300307 300307 300308 300308	ATE Ø 7 / 8" pneumatisch ATE Ø 10" pneumatisch ATE Ø 10" pneumatisch ATE Ø 10" pneumatisch ATE Ø 10" pneumatisch
1.6 MultiFuel	75	07/05→08/13	12/09→; für Rechtslenker; → 10/12; +PR 1AC / 1AT für Linkslenker; → 10/12; +PR 1AC / 1AT; für Kolbendurchmesser [mm]: 22,2 für Linkslenker; → 10/12; +PR 1AC / 1AT; für Kolbendurchmesser [mm]: 23,81		03.7848-9802.4 03.7863-3232.4 03.7863-3332.4	300344 300307 300308	ATE Ø 7 / 8" pneumatisch ATE Ø 10" pneumatisch ATE Ø 10" pneumatisch
1.6 TDI	66	11/10→12/12	+PR 1AC / 1AT; → 10/12; für Rechtslenker für Linkslenker; → 10/12; +PR 1AC / 1AT; für Kolbendurchmesser [mm]: 22,2 für Linkslenker; → 10/12; +PR 1AC / 1AT; für Kolbendurchmesser [mm]: 23,81		03.7848-9802.4 03.7863-3232.4 03.7863-3332.4	300344 300307 300308	ATE Ø 7 / 8" pneumatisch ATE Ø 10" pneumatisch ATE Ø 10" pneumatisch
1.9 TDI 2.0 TDI 2.0 TFSI	66 103 177	06/07→12/10 10/05→10/10 11/06→05/11	+PR 1AC / 1AT; für Rechtslenker → 05/10; +PR 1AC / 1AT; für Linkslenker; für Kolbendurchmesser [mm]: 22,2 06/10→; +PR 1AC / 1AT; für Linkslenker; für Kolbendurchmesser [mm]: 22,2 → 05/10; +PR 1AC / 1AT; für Linkslenker; für Kolbendurchmesser [mm]: 23,81 06/10→; +PR 1AC / 1AT; für Linkslenker; für Kolbendurchmesser [mm]: 23,81		03.7848-9802.4 03.7863-3232.4 03.7863-3232.4 03.7863-3332.4 03.7863-3332.4	300344 300307 300307 300308 300308	ATE Ø 7 / 8" pneumatisch ATE Ø 10" pneumatisch ATE Ø 10" pneumatisch ATE Ø 10" pneumatisch ATE Ø 10" pneumatisch
1.9 TDI	77	07/05→12/10	08/05→; +PR 1AC / 1AT; für Rechtslenker 06/10→; +PR 1AC / 1AT; für Linkslenker; für Kolbendurchmesser [mm]: 22,2 08/05→ 05/10; +PR 1AC / 1AT; für Linkslenker; für Kolbendurchmesser [mm]: 22,2 06/10→; +PR 1AC / 1AT; für Linkslenker; für Kolbendurchmesser [mm]: 23,81 08/05→ 05/10; +PR 1AC / 1AT; für Linkslenker; für Kolbendurchmesser [mm]: 23,81		03.7848-9802.4 03.7863-3232.4 03.7863-3232.4 03.7863-3332.4 03.7863-3332.4	300344 300307 300307 300308 300308	ATE Ø 7 / 8" pneumatisch ATE Ø 10" pneumatisch ATE Ø 10" pneumatisch ATE Ø 10" pneumatisch ATE Ø 10" pneumatisch
2.0 FSI 2.0 TDI 2.0 TFSI	110 100 147	07/05→05/10 07/05→05/10 05/05→03/09	08/05→; +PR 1AC / 1AT; für Rechtslenker 08/05→; +PR 1AC / 1AT; für Linkslenker; für Kolbendurchmesser [mm]: 22,2 08/05→; +PR 1AC / 1AT; für Linkslenker; für Kolbendurchmesser [mm]: 23,81		03.7848-9802.4 03.7863-3232.4 03.7863-3332.4	300344 300307 300308	ATE Ø 7 / 8" pneumatisch ATE Ø 10" pneumatisch ATE Ø 10" pneumatisch
2.0 TFSI	136	09/05→05/06	+PR 1AC / 1AT; für Rechtslenker +PR 1AC / 1AT; für Linkslenker; für Kolbendurchmesser [mm]: 22,2 +PR 1AC / 1AT; für Linkslenker; für Kolbendurchmesser [mm]: 23,81		03.7848-9802.4 03.7863-3232.4 03.7863-3332.4	300344 300307 300308	ATE Ø 7 / 8" pneumatisch ATE Ø 10" pneumatisch ATE Ø 10" pneumatisch
→							









	kw			 	! #			
SEAT - LEON (1P1) 05/05→12/13								
Hauptbremszylinder								
1.2 TSI 1.4 16V 1.4 TSI 1.6 LPG 1.6 TDI 1.8 TSI 2.0 Cupra R 2.0 TDI 2.0 TFSI	77	02/10→12/12		06/10→; +PR 1ZE / 1ZF; → 10/12; für Linkslenker		03.2122-2129.3	010799	ATE Ø 22,2
	63	06/06→12/12						
	92	11/07→12/12		F1P-6-027023→; → 05/10; für Linkslenker; +PR 1AC / 1AT / 1AS		03.2122-2129.3	010799	ATE Ø 22,2
	75	12/09→12/12						
	77	02/10→12/12		06/10→; +PR 1LB / 1ZA / 1ZB; → 10/12; für Linkslenker		03.2123-3449.3	010808	ATE Ø 23,8
	118	06/07→12/12						
	195	09/09→12/12		F1P-6-027023→; → 05/10; für Linkslenker; +PR 1AC / 1AT / 1LJ / 1ZA		03.2123-3449.3	010808	ATE Ø 23,8
	125	05/06→12/12						
	155	06/09→12/12		F1P-6-027023→; → 05/10; für Linkslenker; +PR 1AC / 1AT		24.2122-1788.3	011145	FTE Ø 22,2 ohne Bremsflüssigkeitsbehälter
				→ 05/10; für Rechtslenker		24.2122-1981.3	011024	ATE Ø 22,2 ohne Bremsflüssigkeitsbehälter
					24.4152-0132.3	011025	ATE Ø 22,2 ohne Bremsflüssigkeitsbehälter	
					24.4153-0202.3	011027	ATE Ø 23,8 ohne Bremsflüssigkeitsbehälter	
			06/10→; +PR 1ZE / 1ZF; → 10/12; für Rechtslenker		24.4152-0132.3	011025	ATE Ø 22,2 ohne Bremsflüssigkeitsbehälter	
			F1P-6-027023→; → 05/10; für Rechtslenker; +PR 1AC / 1AT / 1AS		24.4152-0132.3	011025	ATE Ø 22,2 ohne Bremsflüssigkeitsbehälter	
			06/10→; +PR 1LB / 1ZA / 1ZB; → 10/12; für Rechtslenker		24.4153-0202.3	011027	ATE Ø 23,8 ohne Bremsflüssigkeitsbehälter	
			F1P-6-027023→; → 05/10; für Rechtslenker; +PR 1AC / 1AT / 1LJ / 1ZA		24.4153-0202.3	011027	ATE Ø 23,8 ohne Bremsflüssigkeitsbehälter	
1.6 2.0 TDI 16V	75	07/05→12/12		F1P-6-027023→; → 05/10; für Linkslenker; +PR 1AC / 1AT / 1AS		03.2122-2129.3	010799	ATE Ø 22,2
	103	07/05→12/12						
				06/10→; +PR 1ZE / 1ZF; → 10/12; für Linkslenker		03.2122-2129.3	010799	ATE Ø 22,2
				06/10→; +PR 1LB / 1ZA / 1ZB; → 10/12; für Linkslenker		03.2123-3449.3	010808	ATE Ø 23,8
				F1P-6-027023→; → 05/10; für Linkslenker; +PR 1AC / 1AT / 1LJ / 1ZA		03.2123-3449.3	010808	ATE Ø 23,8
				F1P-6-027023→; → 05/10; für Linkslenker; +PR 1AC / 1AT		24.2122-1788.3	011145	FTE Ø 22,2 ohne Bremsflüssigkeitsbehälter
				08/05→ 05/10; für Rechtslenker		24.2122-1981.3	011024	ATE Ø 22,2 ohne Bremsflüssigkeitsbehälter
						24.4152-0132.3	011025	ATE Ø 22,2 ohne Bremsflüssigkeitsbehälter
						24.4153-0202.3	011027	ATE Ø 23,8 ohne Bremsflüssigkeitsbehälter
				06/10→; +PR 1ZE / 1ZF; → 10/12; für Rechtslenker		24.4152-0132.3	011025	ATE Ø 22,2 ohne Bremsflüssigkeitsbehälter
			F1P-6-027023→; → 05/10; für Rechtslenker; +PR 1AC / 1AT / 1AS		24.4152-0132.3	011025	ATE Ø 22,2 ohne Bremsflüssigkeitsbehälter	
			06/10→; +PR 1LB / 1ZA / 1ZB; → 10/12; für Rechtslenker		24.4153-0202.3	011027	ATE Ø 23,8 ohne Bremsflüssigkeitsbehälter	
			F1P-6-027023→; → 05/10; für Rechtslenker; +PR 1AC / 1AT / 1LJ / 1ZA		24.4153-0202.3	011027	ATE Ø 23,8 ohne Bremsflüssigkeitsbehälter	
1.6 MultiFuel	75	07/05→08/13		für Linkslenker; → 10/12; +PR 1ZE / 1ZF		03.2122-2129.3	010799	ATE Ø 22,2
				für Linkslenker; → 10/12; +PR 1LB / 1ZA / 1ZB		03.2123-3449.3	010808	ATE Ø 23,8
				F1P-6-027023→; → 05/10; für Linkslenker; +PR 1AC / 1AT		24.2122-1788.3	011145	FTE Ø 22,2 ohne Bremsflüssigkeitsbehälter
				für Rechtslenker; +PR 1AC / 1AT / 1AS		24.4152-0132.3	011025	ATE Ø 22,2 ohne Bremsflüssigkeitsbehälter
				+PR 1ZE / 1ZF; für Rechtslenker		24.4152-0132.3	011025	ATE Ø 22,2 ohne Bremsflüssigkeitsbehälter
				+PR 1LB / 1ZA / 1ZB; für Rechtslenker		24.4153-0202.3	011027	ATE Ø 23,8 ohne Bremsflüssigkeitsbehälter
			für Rechtslenker; +PR 1AC / 1AT / 1LJ / 1ZA		24.4153-0202.3	011027	ATE Ø 23,8 ohne Bremsflüssigkeitsbehälter	
1.6 TDI	66	11/10→12/12		für Linkslenker; → 10/12; +PR 1ZE / 1ZF		03.2122-2129.3	010799	ATE Ø 22,2
				für Linkslenker; → 10/12; +PR 1LB / 1ZA / 1ZB		03.2123-3449.3	010808	ATE Ø 23,8
				für Rechtslenker; → 10/12; +PR 1ZE / 1ZF		24.4152-0132.3	011025	ATE Ø 22,2 ohne Bremsflüssigkeitsbehälter
				für Rechtslenker; → 10/12; +PR 1LB / 1ZA / 1ZB		24.4153-0202.3	011027	ATE Ø 23,8 ohne Bremsflüssigkeitsbehälter
1.9 TDI 2.0 TDI 2.0 TFSI →	66	06/07→12/10		06/10→; +PR 1ZE / 1ZF; für Linkslenker		03.2122-2129.3	010799	ATE Ø 22,2
	103	10/05→10/10						
	177	11/06→05/11		F1P-6-027023→; → 05/10; für Linkslenker; +PR 1AC / 1AT / 1AS		03.2122-2129.3	010799	ATE Ø 22,2



	kw			 	! #			
SEAT - LEON (1P1) 05/05→12/13								
 Hauptbremszylinder								
1.9 TDI 2.0 TDI 2.0 TFSI	66	06/07→12/10		06/10→; +PR 1LB / 1ZA / 1ZB; für Linkslenker	03.2123-3449.3	010808	ATE Ø 23,8	
	103	10/05→10/10		F1P-6-027023→; → 05/10; für Linkslenker; +PR 1AC / 1AT / 1LJ / 1ZA	03.2123-3449.3	010808	ATE Ø 23,8	
	177	11/06→05/11		F1P-6-027023→; → 05/10; für Linkslenker; +PR 1AC / 1AT	24.2122-1788.3	011145	FTE Ø 22,2 ohne Bremsflüssigkeitsbehälter	
				→ 05/10; für Rechtslenker	24.2122-1981.3	011024	ATE Ø 22,2 ohne Bremsflüssigkeitsbehälter	
					24.4152-0132.3	011025	ATE Ø 22,2 ohne Bremsflüssigkeitsbehälter	
					24.4153-0202.3	011027	ATE Ø 23,8 ohne Bremsflüssigkeitsbehälter	
					24.4152-0132.3	011025	ATE Ø 22,2 ohne Bremsflüssigkeitsbehälter	
					24.4152-0132.3	011025	ATE Ø 22,2 ohne Bremsflüssigkeitsbehälter	
		06/10→; +PR 1ZE / 1ZF; für Rechtslenker	24.4153-0202.3	011027	ATE Ø 23,8 ohne Bremsflüssigkeitsbehälter			
		F1P-6-027023→; → 05/10; für Rechtslenker; +PR 1AC / 1AT / 1AS	24.4152-0132.3	011025	ATE Ø 22,2 ohne Bremsflüssigkeitsbehälter			
1.9 TDI	77	07/05→12/10		F1P-6-027023→; → 05/10; für Linkslenker; +PR 1AC / 1AT / 1AS	03.2122-2129.3	010799	ATE Ø 22,2	
				06/10→; +PR 1ZE / 1ZF; für Linkslenker	03.2122-2129.3	010799	ATE Ø 22,2	
				06/10→; +PR 1LB / 1ZA / 1ZB; für Linkslenker	03.2123-3449.3	010808	ATE Ø 23,8	
				F1P-6-027023→; → 05/10; für Linkslenker; +PR 1AC / 1AT / 1LJ / 1ZA	03.2123-3449.3	010808	ATE Ø 23,8	
				F1P-6-027023→; → 05/10; für Linkslenker; +PR 1AC / 1AT	24.2122-1788.3	011145	FTE Ø 22,2 ohne Bremsflüssigkeitsbehälter	
				08/05→ 05/10; für Rechtslenker	24.2122-1981.3	011024	ATE Ø 22,2 ohne Bremsflüssigkeitsbehälter	
					24.4152-0132.3	011025	ATE Ø 22,2 ohne Bremsflüssigkeitsbehälter	
					24.4153-0202.3	011027	ATE Ø 23,8 ohne Bremsflüssigkeitsbehälter	
					06/10→; +PR 1ZE / 1ZF; für Rechtslenker	24.4152-0132.3	011025	ATE Ø 22,2 ohne Bremsflüssigkeitsbehälter
					F1P-6-027023→; → 05/10; für Rechtslenker; +PR 1AC / 1AT / 1AS	24.4152-0132.3	011025	ATE Ø 22,2 ohne Bremsflüssigkeitsbehälter
					06/10→; +PR 1LB / 1ZA / 1ZB; für Rechtslenker	24.4153-0202.3	011027	ATE Ø 23,8 ohne Bremsflüssigkeitsbehälter
		F1P-6-027023→; → 05/10; für Rechtslenker; +PR 1AC / 1AT / 1LJ / 1ZA	24.4153-0202.3	011027	ATE Ø 23,8 ohne Bremsflüssigkeitsbehälter			
2.0 FSI 2.0 TDI 2.0 TFSI	110	07/05→05/10		F1P-6-027023→; für Linkslenker; +PR 1AC / 1AT / 1AS	03.2122-2129.3	010799	ATE Ø 22,2	
	100	07/05→05/10		F1P-6-027023→; für Linkslenker; +PR 1AC / 1AT / 1LJ / 1ZA	03.2123-3449.3	010808	ATE Ø 23,8	
	147	05/05→03/09		F1P-6-027023→; für Linkslenker; +PR 1AC / 1AT	24.2122-1788.3	011145	FTE Ø 22,2 ohne Bremsflüssigkeitsbehälter	
				08/05→; für Rechtslenker	24.2122-1981.3	011024	ATE Ø 22,2 ohne Bremsflüssigkeitsbehälter	
				F1P-6-027023→; für Rechtslenker; +PR 1AC / 1AT / 1AS	24.4152-0132.3	011025	ATE Ø 22,2 ohne Bremsflüssigkeitsbehälter	
				+PR 1ZE / 1ZF; für Rechtslenker	24.4152-0132.3	011025	ATE Ø 22,2 ohne Bremsflüssigkeitsbehälter	
				F1P-6-027023→; für Rechtslenker; +PR 1AC / 1AT / 1LJ / 1ZA	24.4153-0202.3	011027	ATE Ø 23,8 ohne Bremsflüssigkeitsbehälter	
				+PR 1LB / 1ZA / 1ZB; für Rechtslenker	24.4153-0202.3	011027	ATE Ø 23,8 ohne Bremsflüssigkeitsbehälter	
2.0 TFSI	136	09/05→05/06		F1P-6-027023→; für Linkslenker; +PR 1AC / 1AT / 1AS	03.2122-2129.3	010799	ATE Ø 22,2	
				F1P-6-027023→; für Linkslenker; +PR 1AC / 1AT / 1LJ / 1ZA	03.2123-3449.3	010808	ATE Ø 23,8	
				F1P-6-027023→; für Linkslenker; +PR 1AC / 1AT	24.2122-1788.3	011145	FTE Ø 22,2 ohne Bremsflüssigkeitsbehälter	
				für Rechtslenker	24.2122-1981.3	011024	ATE Ø 22,2 ohne Bremsflüssigkeitsbehälter	
				F1P-6-027023→; für Rechtslenker; +PR 1AC / 1AT / 1AS	24.4152-0132.3	011025	ATE Ø 22,2 ohne Bremsflüssigkeitsbehälter	
				+PR 1ZE / 1ZF; für Rechtslenker	24.4152-0132.3	011025	ATE Ø 22,2 ohne Bremsflüssigkeitsbehälter	

→

	kw			 	! #		
SEAT - LEON (1P1) 05/05→12/13							
 Hauptbremszylinder							
2.0 TFSI	136	09/05→05/06		F1P-6-027023→; für Rechtslenker; +PR 1AC / 1AT / 1LJ / 1ZA	24.4153-0202.3	011027	ATE Ø 23,8 ohne Bremsflüssigkeitsbehälter
				+PR 1LB / 1ZA / 1ZB; für Rechtslenker	24.4153-0202.3	011027	ATE Ø 23,8 ohne Bremsflüssigkeitsbehälter
Drucksensor, Bremskraftverstärker							
1.2 TSI	77	02/10→12/12		+PR 1AS; → 10/12	03.0655-0101.2	370008	ATE
1.4 16V	63	06/06→12/12					
1.4 TSI	92	11/07→12/12					
1.6 LPG	75	12/09→12/12					
1.6 MultiFuel	75	07/05→08/13					
1.6 TDI	66 - 77	02/10→12/12					
1.8 TSI	118	06/07→12/12					
2.0 Cupra R	195	09/09→12/12					
2.0 TDI	125	05/06→12/12					
2.0 TFSI	155	06/09→12/12					
1.6	75	07/05→12/12		08/05→; +PR 1AS; → 10/12	03.0655-0101.2	370008	ATE
2.0 TDI 16V	103	07/05→12/12					
1.9 TDI	66	06/07→12/10		+PR 1AS	03.0655-0101.2	370008	ATE
2.0 TDI	103	10/05→10/10					
2.0 TFSI	136 - 177	09/05→05/11					
1.9 TDI	77	07/05→12/10		08/05→; +PR 1AS	03.0655-0101.2	370008	ATE
2.0 FSI	110	07/05→05/10					
2.0 TDI	100	07/05→05/10					
2.0 TFSI	147	05/05→03/09					
SEAT - LEON (5F1) 09/12→05/21							
 Hauptbremszylinder							
1.0 Tsi	63	09/18→08/20		für Linkslenker	03.4153-5403.3	010994	ATE Ø 23,8
1.5 TGi	96	10/18→08/20			24.4123-1719.3	011017	TRW Ø 23,8 ohne Bremsflüssigkeitsbehälter
1.5 TSI	96 - 110	09/18→08/20					
2.0 TSI	140	09/18→08/20			24.4153-1522.3	011048	ATE Ø 23,8 ohne Bremsflüssigkeitsbehälter
				für Linkslenker; +PR 1ZA / 1ZE	24.4123-1719.3	011017	TRW Ø 23,8 ohne Bremsflüssigkeitsbehälter
					24.4153-1522.3	011048	ATE Ø 23,8 ohne Bremsflüssigkeitsbehälter
1.0 TSI	85	05/15→08/20		für Linkslenker	03.4153-5403.3	010994	ATE Ø 23,8
1.2 TSI	81	04/14→08/20			24.4123-1719.3	011017	TRW Ø 23,8 ohne Bremsflüssigkeitsbehälter
1.4 TSI	92 - 110	05/14→08/20					
2.0 Cupra	213	10/15→08/20			24.4153-1522.3	011048	ATE Ø 23,8 ohne Bremsflüssigkeitsbehälter
				11/16→; für Linkslenker; +PR 1ZA / 1ZE	24.4123-1719.3	011017	TRW Ø 23,8 ohne Bremsflüssigkeitsbehälter
				für Linkslenker; +PR 1ZA / 1ZE	24.4153-1522.3	011048	ATE Ø 23,8 ohne Bremsflüssigkeitsbehälter
1.2 TSI	63 - 77	12/12→08/20		für Linkslenker	03.4153-5403.3	010994	ATE Ø 23,8
1.4 TSI	103	09/12→08/20			24.4123-1719.3	011017	TRW Ø 23,8 ohne Bremsflüssigkeitsbehälter
1.6 TDI	66 - 81	09/12→08/20					
1.8 TSI	132	02/13→08/18		11/16→; für Linkslenker; +PR 1ZA / 1ZE	24.4123-1719.3	011017	TRW Ø 23,8 ohne Bremsflüssigkeitsbehälter
2.0 Cupra	195 - 206	10/13→08/20		02/14→; für Linkslenker	24.4153-1522.3	011048	ATE Ø 23,8 ohne Bremsflüssigkeitsbehälter
2.0 TDI	81 - 135	09/12→08/20		02/14→; für Linkslenker; +PR 1ZA / 1ZE	24.4153-1522.3	011048	ATE Ø 23,8 ohne Bremsflüssigkeitsbehälter
1.4 TGI	81	02/13→08/18		10/13→; für Linkslenker	03.4153-5403.3	010994	ATE Ø 23,8
					24.4123-1719.3	011017	TRW Ø 23,8 ohne Bremsflüssigkeitsbehälter
				11/16→; für Linkslenker; +PR 1ZA / 1ZE	24.4123-1719.3	011017	TRW Ø 23,8 ohne Bremsflüssigkeitsbehälter
				02/14→; für Linkslenker	24.4153-1522.3	011048	ATE Ø 23,8 ohne Bremsflüssigkeitsbehälter
				02/14→; für Linkslenker; +PR 1ZA / 1ZE	24.4153-1522.3	011048	ATE Ø 23,8 ohne Bremsflüssigkeitsbehälter
1.4 TSI	90	11/12→10/16		für Linkslenker	03.4153-5403.3	010994	ATE Ø 23,8
					24.4123-1719.3	011017	TRW Ø 23,8 ohne Bremsflüssigkeitsbehälter
				für Linkslenker; +PR 1ZA / 1ZE	24.4123-1719.3	011017	TRW Ø 23,8 ohne Bremsflüssigkeitsbehälter
→							

	kw			 	! #		
SEAT - LEON (5F1) 09/12→05/21							
 Hauptbremszylinder							
1.4 TSI	90	11/12→10/16		02/14→; für Linkslenker	24.4153-1522.3	011048	ATE Ø 23,8 ohne Bremsflüssigkeitsbehälter
				02/14→; für Linkslenker; +PR 1ZA / 1ZE	24.4153-1522.3	011048	ATE Ø 23,8 ohne Bremsflüssigkeitsbehälter
1.6 TDI	85	11/16→08/20		01/17→; für Linkslenker	03.4153-5403.3	010994	ATE Ø 23,8
				01/17→; für Linkslenker; +PR 1ZA / 1ZE	24.4123-1719.3	011017	TRW Ø 23,8 ohne Bremsflüssigkeitsbehälter
				für Linkslenker; +PR 1ZA / 1ZE	24.4153-1522.3	011048	ATE Ø 23,8 ohne Bremsflüssigkeitsbehälter
				für Linkslenker	24.4153-1522.3	011048	ATE Ø 23,8 ohne Bremsflüssigkeitsbehälter
2.0 Cupra 2.0 Cupra R	221 228	01/17→08/18 11/17→08/18		für Linkslenker; +PR 1ZA / 1ZE	24.4123-1719.3	011017	TRW Ø 23,8 ohne Bremsflüssigkeitsbehälter
					24.4153-1522.3	011048	ATE Ø 23,8 ohne Bremsflüssigkeitsbehälter
SEAT - LEON Kasten/Schrägheck (5F1) 09/12→08/20							
 Hauptbremszylinder							
1.0 TSI 1.2 TSI 1.4 TSI	85 81 110	05/15→08/20 04/14→08/18 05/14→08/20		für Linkslenker	03.4153-5403.3	010994	ATE Ø 23,8
					24.4123-1719.3	011017	TRW Ø 23,8 ohne Bremsflüssigkeitsbehälter
					24.4153-1522.3	011048	ATE Ø 23,8 ohne Bremsflüssigkeitsbehälter
				11/16→; für Linkslenker; +PR 1ZA / 1ZE	24.4123-1719.3	011017	TRW Ø 23,8 ohne Bremsflüssigkeitsbehälter
				für Linkslenker; +PR 1ZA / 1ZE	24.4153-1522.3	011048	ATE Ø 23,8 ohne Bremsflüssigkeitsbehälter
1.2 TSI 1.8 TFSI 2.0 TDI	63 132 110 - 135	01/13→08/18 02/13→08/18 10/12→08/18		für Linkslenker	03.4153-5403.3	010994	ATE Ø 23,8
				11/16→; für Linkslenker; +PR 1ZA / 1ZE	24.4123-1719.3	011017	TRW Ø 23,8 ohne Bremsflüssigkeitsbehälter
				02/14→; für Linkslenker	24.4153-1522.3	011048	ATE Ø 23,8 ohne Bremsflüssigkeitsbehälter
				02/14→; für Linkslenker; +PR 1ZA / 1ZE	24.4153-1522.3	011048	ATE Ø 23,8 ohne Bremsflüssigkeitsbehälter
1.4 TSI 1.6 TDI	90 - 103 66 - 81	09/12→10/16 09/12→10/16		für Linkslenker	03.4153-5403.3	010994	ATE Ø 23,8
				für Linkslenker; +PR 1ZA / 1ZE	24.4123-1719.3	011017	TRW Ø 23,8 ohne Bremsflüssigkeitsbehälter
				02/14→; für Linkslenker	24.4153-1522.3	011048	ATE Ø 23,8 ohne Bremsflüssigkeitsbehälter
				02/14→; für Linkslenker; +PR 1ZA / 1ZE	24.4153-1522.3	011048	ATE Ø 23,8 ohne Bremsflüssigkeitsbehälter
1.6 TDI	85	11/16→08/20		01/17→; für Linkslenker	03.4153-5403.3	010994	ATE Ø 23,8
				01/17→; für Linkslenker; +PR 1ZA / 1ZE	24.4123-1719.3	011017	TRW Ø 23,8 ohne Bremsflüssigkeitsbehälter
				für Linkslenker; +PR 1ZA / 1ZE	24.4153-1522.3	011048	ATE Ø 23,8 ohne Bremsflüssigkeitsbehälter
				für Linkslenker	24.4153-1522.3	011048	ATE Ø 23,8 ohne Bremsflüssigkeitsbehälter
2.0 Cupra	213	09/15→10/16		für Linkslenker	03.4153-5403.3	010994	ATE Ø 23,8
				für Linkslenker; +PR 1ZA / 1ZE	24.4123-1719.3	011017	TRW Ø 23,8 ohne Bremsflüssigkeitsbehälter
					24.4153-1522.3	011048	ATE Ø 23,8 ohne Bremsflüssigkeitsbehälter
2.0 Cupra	221	01/17→08/18		für Linkslenker	03.4153-5403.3	010994	ATE Ø 23,8
					24.4123-1719.3	011017	TRW Ø 23,8 ohne Bremsflüssigkeitsbehälter
					24.4153-1522.3	011048	ATE Ø 23,8 ohne Bremsflüssigkeitsbehälter
				für Linkslenker; +PR 1ZA / 1ZE	24.4123-1719.3	011017	TRW Ø 23,8 ohne Bremsflüssigkeitsbehälter
					24.4153-1522.3	011048	ATE Ø 23,8 ohne Bremsflüssigkeitsbehälter

SEAT - LEON SC (5F5) 01/13→12/18

Hauptbremszylinder









1.0 TSI 1.2 TSI 1.4 TSI 2.0 Cupra	85	05/15→08/18	für Linkslenker		03.4153-5403.3	010994	ATE Ø 23,8		
	81	05/14→08/18					24.4123-1719.3	011017	TRW Ø 23,8 ohne Bremsflüssigkeitsbehälter
	92 - 110	05/14→08/18					24.4153-1522.3	011048	ATE Ø 23,8 ohne Bremsflüssigkeitsbehälter
2.0 Cupra	213	10/15→11/16	11/16→; für Linkslenker; +PR 1ZA / 1ZE		24.4123-1719.3	011017	TRW Ø 23,8 ohne Bremsflüssigkeitsbehälter		
							24.4153-1522.3	011048	ATE Ø 23,8 ohne Bremsflüssigkeitsbehälter
1.2 TSI 1.4 TSI 1.6 TDI 1.8 TSI 2.0 Cupra 2.0 TDI	63	01/13→08/18	für Linkslenker		03.4153-5403.3	010994	ATE Ø 23,8		
	103	02/13→11/16					24.4123-1719.3	011017	TRW Ø 23,8 ohne Bremsflüssigkeitsbehälter
	66 - 81	02/13→08/18					24.4123-1719.3	011017	TRW Ø 23,8 ohne Bremsflüssigkeitsbehälter
	132	02/13→08/18					24.4123-1719.3	011017	TRW Ø 23,8 ohne Bremsflüssigkeitsbehälter
2.0 Cupra	195 - 206	10/13→11/16	02/14→; für Linkslenker		24.4153-1522.3	011048	ATE Ø 23,8 ohne Bremsflüssigkeitsbehälter		
	81 - 135	02/13→08/18					24.4153-1522.3	011048	ATE Ø 23,8 ohne Bremsflüssigkeitsbehälter
1.2 TSI 1.4 TSI	77	02/13→04/14	für Linkslenker		03.4153-5403.3	010994	ATE Ø 23,8		
	90	02/13→06/15					24.4123-1719.3	011017	TRW Ø 23,8 ohne Bremsflüssigkeitsbehälter
							24.4153-1522.3	011048	ATE Ø 23,8 ohne Bremsflüssigkeitsbehälter
1.6 TDI	85	11/16→08/18	01/17→; für Linkslenker		03.4153-5403.3	010994	ATE Ø 23,8		
			01/17→; für Linkslenker; +PR 1ZA / 1ZE		24.4123-1719.3	011017	TRW Ø 23,8 ohne Bremsflüssigkeitsbehälter		
			für Linkslenker; +PR 1ZA / 1ZE		24.4153-1522.3	011048	ATE Ø 23,8 ohne Bremsflüssigkeitsbehälter		
			für Linkslenker		24.4153-1522.3	011048	ATE Ø 23,8 ohne Bremsflüssigkeitsbehälter		
2.0 Cupra	221	01/17→08/18	für Linkslenker; +PR 1ZA / 1ZE		24.4123-1719.3	011017	TRW Ø 23,8 ohne Bremsflüssigkeitsbehälter		
					24.4153-1522.3	011048	ATE Ø 23,8 ohne Bremsflüssigkeitsbehälter		

SEAT - LEON ST (5F8) 09/12→08/20

Hauptbremszylinder













1.0 TSi 1.5 TGi 1.5 TSI 2.0 Cupra 2.0 Cupra 4Drive	63	09/18→08/20	für Linkslenker		03.4153-5403.3	010994	ATE Ø 23,8		
	96	10/18→08/20					24.4123-1719.3	011017	TRW Ø 23,8 ohne Bremsflüssigkeitsbehälter
	96 - 110	09/18→08/20					24.4153-1522.3	011048	ATE Ø 23,8 ohne Bremsflüssigkeitsbehälter
2.0 Cupra	213 - 221	10/15→08/20	für Linkslenker; +PR 1ZA / 1ZE		24.4123-1719.3	011017	TRW Ø 23,8 ohne Bremsflüssigkeitsbehälter		
	221	11/16→08/20					24.4153-1522.3	011048	ATE Ø 23,8 ohne Bremsflüssigkeitsbehälter
1.0 TSI 1.2 TSI 1.4 TSI 1.6 TDI 4Drive 1.8 TSI 4Drive 2.0 TDI 4Drive	85	05/15→08/20	für Linkslenker		03.4153-5403.3	010994	ATE Ø 23,8		
	81	05/14→08/20					24.4123-1719.3	011017	TRW Ø 23,8 ohne Bremsflüssigkeitsbehälter
	92 - 110	05/14→08/20					24.4153-1522.3	011048	ATE Ø 23,8 ohne Bremsflüssigkeitsbehälter
	77 - 81	04/14→08/20					24.4153-1522.3	011048	ATE Ø 23,8 ohne Bremsflüssigkeitsbehälter
1.8 TSI 4Drive 2.0 TDI 4Drive	132	11/14→08/18	11/16→; für Linkslenker; +PR 1ZA / 1ZE		24.4123-1719.3	011017	TRW Ø 23,8 ohne Bremsflüssigkeitsbehälter		
	110 - 135	04/14→08/20					24.4153-1522.3	011048	ATE Ø 23,8 ohne Bremsflüssigkeitsbehälter
1.2 TSI 1.4 TGI 1.4 TSI 1.6 TDI 1.8 TSI 2.0 Cupra 2.0 TDI	63 - 77	08/13→08/20	für Linkslenker		03.4153-5403.3	010994	ATE Ø 23,8		
	81	10/13→08/18					24.4123-1719.3	011017	TRW Ø 23,8 ohne Bremsflüssigkeitsbehälter
	103	10/13→08/20					24.4123-1719.3	011017	TRW Ø 23,8 ohne Bremsflüssigkeitsbehälter
	66 - 81	09/13→08/20					24.4123-1719.3	011017	TRW Ø 23,8 ohne Bremsflüssigkeitsbehälter
	132	10/13→08/18					24.4123-1719.3	011017	TRW Ø 23,8 ohne Bremsflüssigkeitsbehälter
2.0 Cupra	195 - 206	10/13→08/20	02/14→; für Linkslenker		24.4153-1522.3	011048	ATE Ø 23,8 ohne Bremsflüssigkeitsbehälter		
	81 - 135	02/13→08/20					24.4153-1522.3	011048	ATE Ø 23,8 ohne Bremsflüssigkeitsbehälter
1.4 TSI	90	09/12→06/15	für Linkslenker		03.4153-5403.3	010994	ATE Ø 23,8		

























	kw			 	! #			
SEAT - LEON ST (5F8) 09/12→08/20								
 Hauptbremszylinder								
1.4 TSI	90	09/12→06/15		für Linkslenker		24.4123-1719.3	011017	TRW Ø 23,8 ohne Bremsflüssigkeitsbehälter
				für Linkslenker; +PR 1ZA / 1ZE		24.4123-1719.3	011017	TRW Ø 23,8 ohne Bremsflüssigkeitsbehälter
				02/14→; für Linkslenker		24.4153-1522.3	011048	ATE Ø 23,8 ohne Bremsflüssigkeitsbehälter
				02/14→; für Linkslenker; +PR 1ZA / 1ZE		24.4153-1522.3	011048	ATE Ø 23,8 ohne Bremsflüssigkeitsbehälter
1.6 TDI	85	11/16→08/20		01/17→; für Linkslenker		03.4153-5403.3	010994	ATE Ø 23,8
				01/17→; für Linkslenker; +PR 1ZA / 1ZE		24.4123-1719.3	011017	TRW Ø 23,8 ohne Bremsflüssigkeitsbehälter
				für Linkslenker; +PR 1ZA / 1ZE		24.4153-1522.3	011048	ATE Ø 23,8 ohne Bremsflüssigkeitsbehälter
				für Linkslenker		24.4153-1522.3	011048	ATE Ø 23,8 ohne Bremsflüssigkeitsbehälter
1.6 TDI 4Drive 2.0 TSI 2.0 TSI 4Drive	85	07/18→08/20		für Linkslenker		03.4153-5403.3	010994	ATE Ø 23,8
	140	07/18→08/20		für Linkslenker; +PR 1ZA / 1ZE		24.4123-1719.3	011017	TRW Ø 23,8 ohne Bremsflüssigkeitsbehälter
	140	09/18→08/20				24.4153-1522.3	011048	ATE Ø 23,8 ohne Bremsflüssigkeitsbehälter
SEAT - LEON ST Kasten/Kombi (5F8) 01/13→08/20								
 Hauptbremszylinder								
1.0 TSI 1.2 TSI 1.4 TSI 2.0 TDI 4Drive	85	05/15→08/20		für Linkslenker		03.4153-5403.3	010994	ATE Ø 23,8
	81	05/14→08/18				24.4123-1719.3	011017	TRW Ø 23,8 ohne Bremsflüssigkeitsbehälter
	110	05/14→08/20				24.4153-1522.3	011048	ATE Ø 23,8 ohne Bremsflüssigkeitsbehälter
2.0 TDI 4Drive	110 - 135	09/14→08/18				24.4153-1522.3	011048	ATE Ø 23,8 ohne Bremsflüssigkeitsbehälter
				11/16→; für Linkslenker; +PR 1ZA / 1ZE		24.4123-1719.3	011017	TRW Ø 23,8 ohne Bremsflüssigkeitsbehälter
				für Linkslenker; +PR 1ZA / 1ZE		24.4153-1522.3	011048	ATE Ø 23,8 ohne Bremsflüssigkeitsbehälter
1.2 TSI 1.6 TDI 1.8 TFSI 2.0 Cupra 2.0 TDI	63	01/13→08/18		für Linkslenker		03.4153-5403.3	010994	ATE Ø 23,8
	81	09/13→08/20				24.4123-1719.3	011017	TRW Ø 23,8 ohne Bremsflüssigkeitsbehälter
	132	10/13→08/18				24.4123-1719.3	011017	TRW Ø 23,8 ohne Bremsflüssigkeitsbehälter
	206	10/13→08/20				24.4123-1719.3	011017	TRW Ø 23,8 ohne Bremsflüssigkeitsbehälter
2.0 TDI	110 - 135	04/13→08/18		11/16→; für Linkslenker; +PR 1ZA / 1ZE		24.4123-1719.3	011017	TRW Ø 23,8 ohne Bremsflüssigkeitsbehälter
				02/14→; für Linkslenker		24.4153-1522.3	011048	ATE Ø 23,8 ohne Bremsflüssigkeitsbehälter
				02/14→; für Linkslenker; +PR 1ZA / 1ZE		24.4153-1522.3	011048	ATE Ø 23,8 ohne Bremsflüssigkeitsbehälter
1.6 TDI	85	11/16→08/20		01/17→; für Linkslenker		03.4153-5403.3	010994	ATE Ø 23,8
				01/17→; für Linkslenker; +PR 1ZA / 1ZE		24.4123-1719.3	011017	TRW Ø 23,8 ohne Bremsflüssigkeitsbehälter
				für Linkslenker; +PR 1ZA / 1ZE		24.4153-1522.3	011048	ATE Ø 23,8 ohne Bremsflüssigkeitsbehälter
				für Linkslenker		24.4153-1522.3	011048	ATE Ø 23,8 ohne Bremsflüssigkeitsbehälter
2.0 Cupra	221	11/16→08/18		für Linkslenker; +PR 1ZA / 1ZE		24.4123-1719.3	011017	TRW Ø 23,8 ohne Bremsflüssigkeitsbehälter
						24.4153-1522.3	011048	ATE Ø 23,8 ohne Bremsflüssigkeitsbehälter
2.0 Cupra 4Drive	221	11/16→08/18		für Linkslenker		03.4153-5403.3	010994	ATE Ø 23,8
						24.4123-1719.3	011017	TRW Ø 23,8 ohne Bremsflüssigkeitsbehälter
						24.4153-1522.3	011048	ATE Ø 23,8 ohne Bremsflüssigkeitsbehälter
				für Linkslenker; +PR 1ZA / 1ZE		24.4123-1719.3	011017	TRW Ø 23,8 ohne Bremsflüssigkeitsbehälter
						24.4153-1522.3	011048	ATE Ø 23,8 ohne Bremsflüssigkeitsbehälter











	kw				! #		
SEAT - Mii (KF1, KE1) 10/11→							
 Hauptbremszylinder							
1.0	44 - 55	10/11→07/19		05/12→		24.4120-1703.3 011015	TRW Ø 20,6 ohne Bremsflüssigkeitsbehälter
1.0 EcoFuel	50	10/12→07/19				24.4120-1703.3 011015	TRW Ø 20,6 ohne Bremsflüssigkeitsbehälter
SEAT - TOLEDO II (1M2) 10/98→05/06							
 Bremskraftverstärker							
1.4 16V	55	01/00→05/02		1M-1R023639→; für Linkslenker; + ESP		03.7860-0602.4 300141	ATE Ø 10" pneumatisch
1.6	74	10/98→07/04		1M-1B018342→; für Linkslenker; + ESP		03.7860-0602.4 300141	ATE Ø 10" pneumatisch
1.8 20V	92	10/98→07/04					
1.9 TDI	66 - 110	10/98→05/06		→ 1M-1B018341; + ESP; für Linkslenker		03.7863-0402.4 300124	ATE Ø 10" pneumatisch
2.3 V5	110	10/98→11/00		→ 1M-1R023638; + ESP; für Linkslenker		03.7863-0402.4 300124	ATE Ø 10" pneumatisch
2.3 V5 20V	125	09/00→11/03					
1.6 16V	77	06/00→05/06		1M-1R023639→; → 09/04; für Linkslenker; + ESP		03.7860-0602.4 300141	ATE Ø 10" pneumatisch
1.9 TDI	96	05/03→05/06		1M-1B018342→; → 09/04; für Linkslenker; + ESP		03.7860-0602.4 300141	ATE Ø 10" pneumatisch
				→ 1M-1B018341; + ESP; für Linkslenker		03.7863-0402.4 300124	ATE Ø 10" pneumatisch
				→ 1M-1R023638; + ESP; für Linkslenker		03.7863-0402.4 300124	ATE Ø 10" pneumatisch
1.8 20VT	132	09/00→07/04		1M-1B018342→; für Linkslenker; + ESP		03.7860-0602.4 300141	ATE Ø 10" pneumatisch
				1M-1R023639→; für Linkslenker; + ESP		03.7860-0602.4 300141	ATE Ø 10" pneumatisch
				05/01→; → 1M-1B018341; für Linkslenker; + ESP		03.7863-0402.4 300124	ATE Ø 10" pneumatisch
				05/01→; → 1M-1R023638; für Linkslenker; + ESP		03.7863-0402.4 300124	ATE Ø 10" pneumatisch
 Hauptbremszylinder							
1.4 16V	55	01/00→05/02		→ 08/00; für Linkslenker; + ESP		03.2123-2024.3 010597	ATE Ø 23,8
1.6	74	10/98→07/04		09/00→; für Linkslenker; + ESP		03.2123-2715.3 010802	ATE Ø 23,8
1.8 20V	92	10/98→07/04					
1.9 TDI	66 - 81	10/98→07/04		09/00→; + ESP; für Rechtslenker		03.2123-2774.3 010803	ATE Ø 23,8
2.3 V5	110	10/98→11/00		für Linkslenker; - ESP		24.2123-1709.3 010503	Ø 23,8
1.6 16V	77	06/00→05/06		→ 08/00; für Linkslenker; + ESP		03.2123-2024.3 010597	ATE Ø 23,8
				09/00→ 09/04; für Linkslenker; + ESP		03.2123-2715.3 010802	ATE Ø 23,8
				09/00→ 09/04; für Rechtslenker; + ESP		03.2123-2774.3 010803	ATE Ø 23,8
				→ 09/04; - ESP; für Linkslenker		24.2123-1709.3 010503	Ø 23,8
1.8 20VT	132	09/00→07/04		05/01→; + ESP; für Linkslenker		03.2123-2715.3 010802	ATE Ø 23,8
				05/01→; für Rechtslenker; + ESP		03.2123-2774.3 010803	ATE Ø 23,8
1.9 TDI	74 - 110	10/00→05/06		für Linkslenker; + ESP		03.2123-2715.3 010802	ATE Ø 23,8
2.3 V5 20V	125	09/00→11/03		+ ESP; für Rechtslenker		03.2123-2774.3 010803	ATE Ø 23,8
				für Linkslenker; - ESP		24.2123-1709.3 010503	Ø 23,8
1.9 TDI	96	05/03→05/06		→ 09/04; für Linkslenker; + ESP		03.2123-2715.3 010802	ATE Ø 23,8
				→ 09/04; + ESP; für Rechtslenker		03.2123-2774.3 010803	ATE Ø 23,8
				→ 09/04; - ESP; für Linkslenker		24.2123-1709.3 010503	Ø 23,8
SEAT - TOLEDO III (5P2) 04/04→05/09							
 Bremskraftverstärker							
1.4 16V	63	05/06→05/09		→ 03/09; für Linkslenker; +PR 1AC / 1AT		03.7863-3232.4 300307	ATE Ø 10" pneumatisch
1.4 TSI	92	11/07→05/09					
1.6	75	10/04→05/09					
1.8 TFSI	118	01/07→05/09					
1.9 TDI	77	10/04→05/09					
2.0 FSI	110	10/04→05/09					
2.0 TDI	103 - 125	11/05→05/09					
2.0 TFSI	147	11/05→05/09					
2.0 TDI	100	09/04→05/09		10/04→ 03/09; für Linkslenker; +PR 1AC / 1AT		03.7863-3232.4 300307	ATE Ø 10" pneumatisch
2.0 TDI 16V	103	04/04→05/09					
 Hauptbremszylinder							
1.4 16V	63	05/06→05/09		→ 03/09; für Linkslenker		03.2122-2129.3 010799	ATE Ø 22,2
1.4 TSI	92	11/07→05/09					
1.6	75	10/04→05/09					
1.8 TFSI	118	01/07→05/09					
1.9 TDI	77	10/04→05/09		→ 03/09; für Rechtslenker		24.2122-1981.3 011024	ATE Ø 22,2 ohne Bremsflüssigkeitsbehälter
2.0 FSI	110	10/04→05/09					
2.0 TDI	103 - 125	11/05→05/09					
2.0 TFSI	147	11/05→05/09					
→							



























	kw			 	! #		
SEAT - TOLEDO III (5P2) 04/04→05/09							
 Hauptbremszylinder							
2.0 TDI 2.0 TDI 16V	100 103	09/04→05/09 04/04→05/09		10/04→ 03/09; für Linkslenker	03.2122-2129.3 010799 24.2122-1788.3 011145	ATE Ø 22,2 FTE Ø 22,2 ohne Bremsflüssigkeitsbehälter	
				10/04→ 03/09; für Rechtslenker	24.2122-1981.3 011024	ATE Ø 22,2 ohne Bremsflüssigkeitsbehälter	
Drucksensor, Bremskraftverstärker							
1.4 16V 1.4 TSI 1.6 1.8 TFSI 1.9 TDI 2.0 FSI 2.0 TDI 2.0 TFSI 2.0 TDI 2.0 TDI 16V	63 92 75 118 77 110 103 - 125 147 100 103	05/06→05/09 11/07→05/09 10/04→05/09 01/07→05/09 10/04→05/09 10/04→05/09 11/05→05/09 11/05→05/09 09/04→05/09 04/04→05/09		→ 03/09; für Linkslenker; +PR 1AS 10/04→ 03/09; für Linkslenker; +PR 1AS	03.0655-0101.2 370008 03.0655-0101.2 370008	ATE ATE	
SKODA - CITIGO (NF1) 10/11→08/19							
 Hauptbremszylinder							
1.0 1.0 CNG	44 - 55 50	10/11→08/19 11/12→08/19		05/12→	24.4120-1703.3 011015 24.4120-1703.3 011015	TRW Ø 20,6 ohne Bremsflüssigkeitsbehälter TRW Ø 20,6 ohne Bremsflüssigkeitsbehälter	
SKODA - FABIA I (6Y2) 08/99→03/08							
 Hauptbremszylinder							
1.0 1.4 1.2 1.2 1.4 16V 1.4 TDI 1.9 SDI 2.0 1.4 1.9 TDI 1.9 TDI RS	37 50 40 47 55 - 74 51 - 59 47 85 44 - 59 74 96	12/99→08/02 08/99→05/03 07/01→04/07 01/03→03/08 12/99→03/08 04/03→03/08 12/99→03/08 12/99→03/08 08/00→10/06 01/00→03/08 06/03→03/08		02/00→; + ABS 02/00→; - ABS 08/02→; + ABS 08/02→; - ABS → 12/07; + ABS → 12/07; - ABS + ABS - ABS 02/00→ 12/07; + ABS 02/00→ 12/07; - ABS 09/03→ 12/07; + ABS 09/03→ 12/07; - ABS	24.2120-1734.3 010702 24.2120-1736.3 010732 24.2120-1734.3 010702 24.2120-1736.3 010732 24.2120-1734.3 010702 24.2120-1736.3 010732 24.2120-1734.3 010702 24.2120-1736.3 010732 24.2120-1734.3 010702 24.2120-1736.3 010732 24.2120-1734.3 010702 24.2120-1736.3 010732	Ø 20,6 Ø 20,6 Ø 20,6 Ø 20,6 Ø 20,6 Ø 20,6 Ø 20,6 Ø 20,6 Ø 20,6 Ø 20,6 Ø 20,6	
 Bremskraftregler							
1.4 1.4 1.4 16V 1.4 TDI 1.9 SDI 2.0 1.9 TDI 1.9 TDI RS	44 - 59 50 55 - 74 51 - 59 47 85 74 96	08/00→10/06 08/99→05/03 12/99→03/08 04/03→03/08 12/99→03/08 12/99→03/08 01/00→03/08 06/03→03/08		+PR 1AL; - ABS; Schrägheck 02/00→; +PR 1AL; - ABS; Schrägheck → 12/07; +PR 1AL; - ABS; Schrägheck 02/00→ 12/07; +PR 1AL; - ABS; Schrägheck 09/03→ 12/07; +PR 1AL; - ABS; Schrägheck	03.6583-0216.3 320247 03.6583-0216.3 320247 03.6583-0216.3 320247 03.6583-0216.3 320247 03.6583-0216.3 320247 03.6583-0216.3 320247 03.6583-0216.3 320247 03.6583-0216.3 320247	ATE lastabhängig 8/3 4x ATE lastabhängig 8/3 4x ATE lastabhängig 8/3 4x ATE lastabhängig 8/3 4x ATE lastabhängig 8/3 4x	
SKODA - FABIA I Combi (6Y5) 04/00→12/07							
 Hauptbremszylinder							
1.2 1.2 1.4 1.4 16V →	40 47 44 - 50 55 - 74	07/01→12/07 01/03→12/07 04/00→05/03 04/00→12/07		08/02→; + ABS 08/02→; - ABS + ABS - ABS	24.2120-1734.3 010702 24.2120-1736.3 010732 24.2120-1734.3 010702 24.2120-1736.3 010732	Ø 20,6 Ø 20,6 Ø 20,6 Ø 20,6	













	kw			i 	! #		
SKODA - FABIA I Combi (6Y5) 04/00→12/07							
 Hauptbremszylinder							
1.4 TDI	51 - 59	04/03→12/07		+ ABS		24.2120-1734.3 010702	Ø 20,6
1.9 SDI	47	04/00→12/07		- ABS		24.2120-1736.3 010732	Ø 20,6
1.9 TDI	74	04/00→12/07					
2.0	85	04/00→12/07					
 Bremskraftregler							
1.4	44 - 50	04/00→05/03		+PR 1AL; - ABS; Schrägheck		03.6583-0216.3 320247	ATE lastabhängig 8/3 4x
1.4 16V	55 - 74	04/00→12/07					
1.4 TDI	51 - 59	04/03→12/07					
1.9 SDI	47	04/00→12/07					
1.9 TDI	74	04/00→12/07					
2.0	85	04/00→12/07					
SKODA - FABIA I Praktik (6Y5) 01/00→12/07							
 Hauptbremszylinder							
1.2	40	07/01→12/07		08/02→; + ABS		24.2120-1734.3 010702	Ø 20,6
				08/02→; - ABS		24.2120-1736.3 010732	Ø 20,6
1.2	47	01/03→12/07		+ ABS		24.2120-1734.3 010702	Ø 20,6
1.4	44 - 55	04/00→12/07		- ABS		24.2120-1736.3 010732	Ø 20,6
1.4 TDI	51 - 55	08/04→12/07					
1.9 SDI	47	07/01→12/07					
1.9 TDI	74	01/00→12/07		02/00→; + ABS		24.2120-1734.3 010702	Ø 20,6
				02/00→; - ABS		24.2120-1736.3 010732	Ø 20,6
 Bremskraftregler							
1.4	44 - 55	04/00→12/07		+PR 1AL; - ABS; Schrägheck		03.6583-0216.3 320247	ATE lastabhängig 8/3 4x
1.4 TDI	51 - 55	08/04→12/07					
1.9 SDI	47	07/01→12/07					
1.9 TDI	74	01/00→12/07		02/00→; +PR 1AL; - ABS; Schrägheck		03.6583-0216.3 320247	ATE lastabhängig 8/3 4x
SKODA - FABIA I Stufenheck (6Y3) 10/99→12/07							
 Hauptbremszylinder							
1.2	40	07/01→12/07		08/02→; + ABS		24.2120-1734.3 010702	Ø 20,6
				08/02→; - ABS		24.2120-1736.3 010732	Ø 20,6
1.2	47	01/03→12/07		+ ABS		24.2120-1734.3 010702	Ø 20,6
1.4	44 - 50	04/00→05/03		- ABS		24.2120-1736.3 010732	Ø 20,6
1.4 16V	55 - 74	10/99→12/07					
1.4 TDI	51 - 59	04/03→12/07					
2.0	85	12/99→12/07					
1.9 SDI	47	11/99→12/07		12/99→; + ABS		24.2120-1734.3 010702	Ø 20,6
				12/99→; - ABS		24.2120-1736.3 010732	Ø 20,6
1.9 TDI	74	01/00→12/07		02/00→; + ABS		24.2120-1734.3 010702	Ø 20,6
				02/00→; - ABS		24.2120-1736.3 010732	Ø 20,6
 Bremskraftregler							
1.4	44 - 50	04/00→05/03		+PR 1AL; - ABS; Schrägheck		03.6583-0216.3 320247	ATE lastabhängig 8/3 4x
1.4 16V	55 - 74	10/99→12/07					
1.4 TDI	51 - 59	04/03→12/07					
2.0	85	12/99→12/07					
1.9 SDI	47	11/99→12/07		12/99→; +PR 1AL; - ABS; Schrägheck		03.6583-0216.3 320247	ATE lastabhängig 8/3 4x
1.9 TDI	74	01/00→12/07		02/00→; +PR 1AL; - ABS; Schrägheck		03.6583-0216.3 320247	ATE lastabhängig 8/3 4x
SKODA - FABIA II (542) 12/06→12/14							
 Hauptbremszylinder							
1.2	44	12/06→12/14		03/07→ 06/14; +PR 1AL / 1LB / 1LM; für Linksklenker; - ABS		24.2119-1716.3 011120	FTE Ø 19 ohne Bremsflüssigkeitsbehälter
→				03/07→ 06/14; +PR 1LN / 1LQ / 1LR; für Linksklenker; + ABS		24.2120-1734.3 010702	Ø 20,6











	kw			 	! #		
SKODA - FABIA II (542) 12/06→12/14							
 Hauptbremszylinder							
1.2	44	12/06→12/14		03/07→06/14; +PR 1AL / 1LQ / 1LN / 1LR; für Linkslenker; - ABS		24.2120-1736.3 010732	Ø 20,6
1.2	51	01/07→12/14		03/07→06/14; +PR 1AL / 1LB / 1LM; für Linkslenker; - ABS		24.2119-1716.3 011120	FTE Ø 19 ohne Bremsflüssigkeitsbehälter
1.4	63	01/07→12/14					
1.4 LPG	63	01/07→11/14		03/07→06/14; +PR 1AC / 1AR / 1AT / 1LN / 1LQ / 1LR; für Linkslenker; + ABS		24.2120-1734.3 010702	Ø 20,6
				03/07→06/14; +PR 1AL / 1LQ / 1LN / 1LR; für Linkslenker; - ABS		24.2120-1736.3 010732	Ø 20,6
1.2 12V	44	11/11→12/14		→ 06/14; +PR 1AL / 1LB / 1LM; für Linkslenker; - ABS		24.2119-1716.3 011120	FTE Ø 19 ohne Bremsflüssigkeitsbehälter
				→ 06/14; +PR 1LN / 1LQ / 1LR; für Linkslenker; + ABS		24.2120-1734.3 010702	Ø 20,6
				→ 06/14; +PR 1AL / 1LQ / 1LN / 1LR; für Linkslenker; - ABS		24.2120-1736.3 010732	Ø 20,6
1.2 12V	55	10/10→12/14		+PR 1AL / 1LB / 1LM; für Linkslenker; - ABS		24.2119-1716.3 011120	FTE Ø 19 ohne Bremsflüssigkeitsbehälter
1.2 LPG	44	03/09→11/11		für Linkslenker; +PR 1AC / 1AR / 1AT / 1LN / 1LQ / 1LR; + ABS		24.2120-1734.3 010702	Ø 20,6
				+PR 1AL / 1LQ / 1LN / 1LR; für Linkslenker; - ABS		24.2120-1736.3 010732	Ø 20,6
1.2 LPG	51	07/07→11/14		→ 06/14; +PR 1AL / 1LB / 1LM; für Linkslenker; - ABS		24.2119-1716.3 011120	FTE Ø 19 ohne Bremsflüssigkeitsbehälter
1.2 TSI	63 - 77	03/10→12/14					
1.4 TSI RS	132	05/10→12/14		→ 06/14; +PR 1AC / 1AR / 1AT / 1LN / 1LQ / 1LR; für Linkslenker; + ABS		24.2120-1734.3 010702	Ø 20,6
1.6	77	04/07→12/14		→ 06/14; +PR 1AL / 1LQ / 1LN / 1LR; für Linkslenker; - ABS		24.2120-1736.3 010732	Ø 20,6
1.2 TDI	55	05/10→12/14		→ 06/14; +PR 1AL / 1LB / 1LM; für Linkslenker; - ABS		24.2119-1716.3 011120	FTE Ø 19 ohne Bremsflüssigkeitsbehälter
1.6 TDI	55 - 77	03/10→12/14		→ 06/14; +PR 1AC / 1AR / 1AT / 1LN / 1LQ / 1LR; für Linkslenker; + ABS		24.2120-1734.3 010702	Ø 20,6
				→ 06/14; +PR 1AL / 1LQ / 1LN / 1LR; für Linkslenker; - ABS		24.2120-1736.3 010732	Ø 20,6
				→ 06/14; +PR 1AC / 1AR / 1AT / 1LN / 1LQ / 1LR; für Rechtslenker; + ABS; für Fahrzeuge mit Rußpartikelfilter		24.2120-1768.3 011041	Ø 20,6 ohne Bremsflüssigkeitsbehälter
1.4 TDI	51 - 59	01/07→03/10		03/07→; +PR 1AL / 1LB / 1LM; für Linkslenker; - ABS		24.2119-1716.3 011120	FTE Ø 19 ohne Bremsflüssigkeitsbehälter
				03/07→; +PR 1AC / 1AR / 1AT / 1LN / 1LQ / 1LR; für Linkslenker; + ABS		24.2120-1734.3 010702	Ø 20,6
				03/07→; +PR 1AL / 1LQ / 1LN / 1LR; für Linkslenker; - ABS		24.2120-1736.3 010732	Ø 20,6
				03/07→; +PR 1AC / 1AR / 1AT / 1LN / 1LQ / 1LR; für Rechtslenker; + ABS; für Fahrzeuge mit Rußpartikelfilter		24.2120-1768.3 011041	Ø 20,6 ohne Bremsflüssigkeitsbehälter
1.9 TDI	77	04/07→03/10		+PR 1AL / 1LB / 1LM; für Linkslenker; - ABS		24.2119-1716.3 011120	FTE Ø 19 ohne Bremsflüssigkeitsbehälter
				für Linkslenker; +PR 1AC / 1AR / 1AT / 1LN / 1LQ / 1LR; + ABS		24.2120-1734.3 010702	Ø 20,6
				+PR 1AL / 1LQ / 1LN / 1LR; für Linkslenker; - ABS		24.2120-1736.3 010732	Ø 20,6
				für Rechtslenker; +PR 1AC / 1AR / 1AT / 1LN / 1LQ / 1LR; + ABS; für Fahrzeuge mit Rußpartikelfilter		24.2120-1768.3 011041	Ø 20,6 ohne Bremsflüssigkeitsbehälter
 Bremskraftregler							
1.2	44 - 51	12/06→12/14		03/07→06/14; - ABS		03.6583-0216.3 320247	ATE lastabhängig 8/3 4x
1.4	63	01/07→12/14					
1.4 LPG	63	01/07→11/14					
1.2 12V	44	11/11→12/14		→ 06/14; - ABS		03.6583-0216.3 320247	ATE lastabhängig 8/3 4x
1.2 LPG	51	07/07→11/14					
1.2 TDI	55	05/10→12/14					
1.2 TSI	63 - 77	03/10→12/14					
1.6	77	04/07→12/14					
1.6 TDI	55 - 77	03/10→12/14					
1.2 12V	55	10/10→12/14		- ABS		03.6583-0216.3 320247	ATE lastabhängig 8/3 4x
1.2 LPG	44	03/09→11/11					
1.9 TDI	77	04/07→03/10					
1.4 TDI	51 - 59	01/07→03/10		03/07→; - ABS		03.6583-0216.3 320247	ATE lastabhängig 8/3 4x









	kw			 	! #			
SKODA - FABIA II Combi (545) 10/07→12/14								
 Hauptbremszylinder								
1.2 1.2 12V	44 44	10/07→11/14 11/11→12/14		→ 06/14; +PR 1AL / 1LB / 1LM; für Linkslenker; - ABS	24.2119-1716.3	011120	FTE Ø 19 ohne Bremsflüssigkeitsbehälter	
				→ 06/14; +PR 1LN / 1LQ / 1LR; für Linkslenker; + ABS	24.2120-1734.3	010702	Ø 20,6	
				→ 06/14; +PR 1AL / 1LQ / 1LN / 1LR; für Linkslenker; - ABS	24.2120-1736.3	010732	Ø 20,6	
1.2 1.2 LPG 1.2 TSI	51 51 63 - 77	10/07→12/14 10/07→11/14 03/10→12/14		→ 06/14; +PR 1AL / 1LB / 1LM; für Linkslenker; - ABS	24.2119-1716.3	011120	FTE Ø 19 ohne Bremsflüssigkeitsbehälter	
				→ 06/14; +PR 1AC / 1AR / 1AT / 1LN / 1LQ / 1LR; für Linkslenker; + ABS	24.2120-1734.3	010702	Ø 20,6	
1.4 1.4 LPG 1.4 TSI RS 1.6	63 63 132 77	10/07→12/14 10/07→11/14 05/10→12/14 10/07→12/14		→ 06/14; +PR 1AL / 1LQ / 1LN / 1LR; für Linkslenker; - ABS	24.2120-1736.3	010732	Ø 20,6	
1.2 LPG	44	03/09→11/11		+PR 1AL / 1LB / 1LM; für Linkslenker; - ABS	24.2119-1716.3	011120	FTE Ø 19 ohne Bremsflüssigkeitsbehälter	
				für Linkslenker; +PR 1AC / 1AR / 1AT / 1LN / 1LQ / 1LR; + ABS	24.2120-1734.3	010702	Ø 20,6	
				+PR 1AL / 1LQ / 1LN / 1LR; für Linkslenker; - ABS	24.2120-1736.3	010732	Ø 20,6	
1.2 TDI 1.6 TDI	55 55 - 77	05/10→12/14 03/10→12/14		→ 06/14; +PR 1AL / 1LB / 1LM; für Linkslenker; - ABS	24.2119-1716.3	011120	FTE Ø 19 ohne Bremsflüssigkeitsbehälter	
				→ 06/14; +PR 1AC / 1AR / 1AT / 1LN / 1LQ / 1LR; für Linkslenker; + ABS	24.2120-1734.3	010702	Ø 20,6	
				→ 06/14; +PR 1AL / 1LQ / 1LN / 1LR; für Linkslenker; - ABS	24.2120-1736.3	010732	Ø 20,6	
				→ 06/14; +PR 1AC / 1AR / 1AT / 1LN / 1LQ / 1LR; für Rechtslenker; + ABS; für Fahrzeuge mit Rußpartikelfilter	24.2120-1768.3	011041	Ø 20,6 ohne Bremsflüssigkeitsbehälter	
1.4 TDI 1.9 TDI	51 - 59 77	10/07→03/10 10/07→03/10		+PR 1AL / 1LB / 1LM; für Linkslenker; - ABS	24.2119-1716.3	011120	FTE Ø 19 ohne Bremsflüssigkeitsbehälter	
				für Linkslenker; +PR 1AC / 1AR / 1AT / 1LN / 1LQ / 1LR; + ABS	24.2120-1734.3	010702	Ø 20,6	
				+PR 1AL / 1LQ / 1LN / 1LR; für Linkslenker; - ABS	24.2120-1736.3	010732	Ø 20,6	
				für Rechtslenker; +PR 1AC / 1AR / 1AT / 1LN / 1LQ / 1LR; + ABS; für Fahrzeuge mit Rußpartikelfilter	24.2120-1768.3	011041	Ø 20,6 ohne Bremsflüssigkeitsbehälter	
 Bremskraftregler								
1.2 1.2 12V 1.2 LPG 1.2 TDI 1.2 TSI 1.4 1.4 LPG 1.6 1.6 TDI	44 - 51 44 51 55 63 - 77 63 63 77 55 - 77	10/07→12/14 11/11→12/14 10/07→11/14 05/10→12/14 03/10→12/14 10/07→12/14 10/07→11/14 10/07→12/14 03/10→12/14		→ 06/14; - ABS	03.6583-0216.3	320247	ATE lastabhängig 8/3 4x	
1.2 LPG 1.4 TDI 1.9 TDI	44 51 - 59 77	03/09→11/11 10/07→03/10 10/07→03/10		- ABS	03.6583-0216.3	320247	ATE lastabhängig 8/3 4x	
SKODA - FABIA II Praktik (545) 12/06→12/14								
 Hauptbremszylinder								
TDI	55	10/13→11/14		→ 06/14; +PR 1AL / 1LB / 1LM; für Linkslenker; - ABS	24.2119-1716.3	011120	FTE Ø 19 ohne Bremsflüssigkeitsbehälter	
				→ 06/14; +PR 1AC / 1AR / 1AT / 1LN / 1LQ / 1LR; für Linkslenker; + ABS	24.2120-1734.3	010702	Ø 20,6	
				→ 06/14; +PR 1AL / 1LQ / 1LN / 1LR; für Linkslenker; - ABS	24.2120-1736.3	010732	Ø 20,6	
				→ 06/14; +PR 1AC / 1AR / 1AT / 1LN / 1LQ / 1LR; für Rechtslenker; + ABS; für Fahrzeuge mit Rußpartikelfilter	24.2120-1768.3	011041	Ø 20,6 ohne Bremsflüssigkeitsbehälter	
 Bremskraftregler								
TDI	55	10/13→11/14		→ 06/14; - ABS	03.6583-0216.3	320247	ATE lastabhängig 8/3 4x	

	kw			 	! #		
SKODA - FELICIA I Pick-up (6UF, 6U7) 10/95→04/02							
 Hauptbremszylinder							
1.3	40	06/97→04/02		→ 12/00; - ABS		24.2122-1731.3 010656	Ø 22,2
1.3	43	10/95→04/02		06/97→ 12/00; - ABS		24.2122-1731.3 010656	Ø 22,2
1.3	50	06/97→04/02		→ 12/00		24.2122-1731.3 010656	Ø 22,2
1.9 D	47	06/97→04/02					
1.6	55	06/97→04/02		→ 12/99		24.2122-1731.3 010656	Ø 22,2
 Bremskraftregler							
1.3	40 - 50	06/97→04/02		→ 12/00		03.6584-0107.3 320110	ATE lastabhängig 8/4 4x
1.3	43	10/95→04/02		06/97→ 12/00		03.6584-0107.3 320110	ATE lastabhängig 8/4 4x
1.6	55	06/97→04/02		→ 12/99		03.6584-0107.3 320110	ATE lastabhängig 8/4 4x
SKODA - KAMIQ (NW4) 07/19→							
 Hauptbremszylinder							
1.0 TGI CNG	66	11/19→		für Linkslenker; +PR 1ZA / 1ZE / 1ZS		24.2123-1782.3 011146	TRW Ø 23,8 ohne Bremsflüssigkeitsbehälter
1.0 TSI	70 - 85	07/19→					
1.5 TSI	110	07/19→					
1.6 SRE	81	07/19→					
1.6 TDI	70 - 85	07/19→					
SKODA - KAROQ (NU7, ND7) 07/17→							
 Hauptbremszylinder							
1.0 TSI	81 - 85	07/17→		für Linkslenker		24.4123-1719.3 011017	TRW Ø 23,8 ohne Bremsflüssigkeitsbehälter
1.4 TSI	110	07/17→					
1.4 TSI 4x4	110	09/19→				24.4153-1522.3 011048	ATE Ø 23,8 ohne Bremsflüssigkeitsbehälter
1.5 TSI	110	07/17→					
1.5 TSI 4x4	110	07/17→					
1.6 SRE	81	07/17→					
1.6 TDI	85	07/17→					
2.0 TDI	85 - 110	07/17→					
2.0 TDI 4x4	110 - 140	07/17→					
2.0 TSI 4x4	140	04/19→					
SKODA - KODIAQ I (NS6, NS7, NV7) 10/16→							
 Hauptbremszylinder							
1.4 TSI	92 - 110	10/16→		für Linkslenker; +PR 1ZA		24.4123-1719.3 011017	TRW Ø 23,8 ohne Bremsflüssigkeitsbehälter
1.4 TSI 4x4	110	10/16→					
1.5 TSI	110	07/18→					
1.5 TSI 4x4	110	07/18→					
2.0 RS 4x4	180	06/21→					
2.0 RS Bi-TDI 4x4	176	11/18→					
2.0 TDI	85 - 110	10/16→					
2.0 TDI 4x4	110 - 147	10/16→					
2.0 TSI 4x4	132 - 140	10/16→					
SKODA - OCTAVIA I (1U2) 09/96→12/10							
 Bremskraftverstärker							
1.4	44	04/99→03/01		→ 07/00; für Linkslenker; + ESP		03.7863-0402.4 300124	ATE Ø 10" pneumatisch
1.4 16V	55	09/00→12/10		05/01→ 06/10; +PR 1AC / 1AH / 1AJ / 1AT; für Linkslenker		03.7863-3502.4 300128	ATE Ø 10" pneumatisch
1.6	75	11/00→12/10					
1.6	55	09/96→09/04		10/96→ 07/00; für Linkslenker; + ESP		03.7863-0402.4 300124	ATE Ø 10" pneumatisch
1.9 TDI	66	09/96→03/10		05/01→; +PR 1AC / 1AH / 1AJ / 1AT; für Linkslenker		03.7863-3502.4 300128	ATE Ø 10" pneumatisch
1.6	74	02/97→12/07		→ 07/00; für Linkslenker; + ESP		03.7863-0402.4 300124	ATE Ø 10" pneumatisch
1.9 SDI	50	06/97→12/03					
1.9 TDI	81	08/97→01/06		05/01→; +PR 1AC / 1AH / 1AJ / 1AT; für Linkslenker		03.7863-3502.4 300128	ATE Ø 10" pneumatisch
2.0	85	04/99→05/07					
1.8	92	09/96→07/00		10/96→; für Linkslenker; + ESP		03.7863-0402.4 300124	ATE Ø 10" pneumatisch
1.8 T	110	08/97→12/10		03/98→ 07/00; für Linkslenker; + ESP		03.7863-0402.4 300124	ATE Ø 10" pneumatisch
				05/01→ 06/10; +PR 1AC / 1AH / 1AJ / 1AT; für Linkslenker		03.7863-3502.4 300128	ATE Ø 10" pneumatisch
1.8 T 4x4	110	05/01→05/06		+PR 1AC / 1AH / 1AJ / 1AT; für Linkslenker		03.7863-3502.4 300128	ATE Ø 10" pneumatisch
RS 1.8 T	132	05/01→01/06					
→							

	kw			 	! #		
SKODA - OCTAVIA I (1U2) 09/96→12/10							
 Bremskraftverstärker							
1.9 TDI	74	10/05→12/10		→ 06/10; +PR 1AC / 1AH / 1AJ / 1AT; für Linkslenker		03.7863-3502.4 300128	ATE Ø 10" pneumatisch
1.9 TDI	96	09/02→09/04		01/03→; +PR 1AC / 1AH / 1AJ / 1AT; für Linkslenker		03.7863-3502.4 300128	ATE Ø 10" pneumatisch
 Hauptbremszylinder							
1.4	44	04/99→03/01		→ 07/00; für Linkslenker; + ESP		03.2123-2024.3 010597	ATE Ø 23,8
1.6	74	02/97→12/07		08/00→; für Linkslenker; +PR 1AT		03.2123-2715.3 010802	ATE Ø 23,8
1.9 SDI	50	06/97→12/03		08/00→; für Rechtslenker; +PR 1AT		03.2123-2774.3 010803	ATE Ø 23,8
1.9 TDI	81	08/97→01/06		08/00→; für Rechtslenker; +PR 1AT		03.2123-2774.3 010803	ATE Ø 23,8
2.0	85	04/99→05/07		08/00→; für Linkslenker; +PR 1AC / 1AH / 1AJ		03.2123-2973.3 010951	ATE Ø 23,8
				08/00→; für Linkslenker; +PR 1AM		24.2123-1709.3 010503	Ø 23,8
				→ 07/00; für Linkslenker; - ESP		24.2123-1709.3 010503	Ø 23,8
1.4 16V	55	09/00→12/10		für Linkslenker; → 06/10; +PR 1AT		03.2123-2715.3 010802	ATE Ø 23,8
1.6	75	11/00→12/10		für Rechtslenker; → 06/10; +PR 1AT		03.2123-2774.3 010803	ATE Ø 23,8
1.9 TDI	74	10/05→12/10		für Rechtslenker; → 06/10; +PR 1AT		03.2123-2774.3 010803	ATE Ø 23,8
				für Linkslenker; → 06/10; +PR 1AC / 1AH / 1AJ		03.2123-2973.3 010951	ATE Ø 23,8
				für Linkslenker; → 06/10; +PR 1AM		24.2123-1709.3 010503	Ø 23,8
1.6	55	09/96→09/04		10/96→ 07/00; für Linkslenker; + ESP		03.2123-2024.3 010597	ATE Ø 23,8
1.9 TDI	66	09/96→03/10		08/00→; für Linkslenker; +PR 1AT		03.2123-2715.3 010802	ATE Ø 23,8
				08/00→; für Rechtslenker; +PR 1AT		03.2123-2774.3 010803	ATE Ø 23,8
				08/00→; für Linkslenker; +PR 1AC / 1AH / 1AJ		03.2123-2973.3 010951	ATE Ø 23,8
				08/00→; für Linkslenker; +PR 1AM		24.2123-1709.3 010503	Ø 23,8
				10/96→ 07/00; für Linkslenker; - ESP		24.2123-1709.3 010503	Ø 23,8
1.8	92	09/96→07/00		10/96→; für Linkslenker; + ESP		03.2123-2024.3 010597	ATE Ø 23,8
				10/96→; für Linkslenker; - ESP		24.2123-1709.3 010503	Ø 23,8
1.8 T	110	08/97→12/10		03/98→ 07/00; für Linkslenker; + ESP		03.2123-2024.3 010597	ATE Ø 23,8
				08/00→ 06/10; für Linkslenker; +PR 1AT		03.2123-2715.3 010802	ATE Ø 23,8
				08/00→ 06/10; für Rechtslenker; +PR 1AT		03.2123-2774.3 010803	ATE Ø 23,8
				08/00→ 06/10; für Linkslenker; +PR 1AC / 1AH / 1AJ		03.2123-2973.3 010951	ATE Ø 23,8
				08/00→ 06/10; für Linkslenker; +PR 1AM		24.2123-1709.3 010503	Ø 23,8
				03/98→ 07/00; für Linkslenker; - ESP		24.2123-1709.3 010503	Ø 23,8
1.8 T 4x4	110	05/01→05/06		für Linkslenker; +PR 1AT		03.2123-2715.3 010802	ATE Ø 23,8
RS 1.8 T	132	05/01→01/06		für Rechtslenker; +PR 1AT		03.2123-2774.3 010803	ATE Ø 23,8
				für Linkslenker; +PR 1AC / 1AH / 1AJ		03.2123-2973.3 010951	ATE Ø 23,8
				für Linkslenker; +PR 1AM		24.2123-1709.3 010503	Ø 23,8
1.9 TDI	96	09/02→09/04		01/03→; für Linkslenker; +PR 1AT		03.2123-2715.3 010802	ATE Ø 23,8
				01/03→; für Rechtslenker; +PR 1AT		03.2123-2774.3 010803	ATE Ø 23,8
				01/03→; für Linkslenker; +PR 1AC / 1AH / 1AJ		03.2123-2973.3 010951	ATE Ø 23,8
				01/03→; für Linkslenker; +PR 1AM		24.2123-1709.3 010503	Ø 23,8
 Bremskraftregler							
1.4	44	04/99→03/01		Trommelbremse		03.6584-0107.3 320110	ATE lastabhängig 8/4 4x
1.6	74	02/97→12/07					
1.9 SDI	50	06/97→12/03					
1.4 16V	55	09/00→12/10		→ 06/10; Trommelbremse		03.6584-0107.3 320110	ATE lastabhängig 8/4 4x
1.6	75	11/00→12/10					
1.6	55	09/96→09/04		10/96→; Trommelbremse		03.6584-0107.3 320110	ATE lastabhängig 8/4 4x
1.9 TDI	66	09/96→03/10					
SKODA - OCTAVIA I Combi (1U5) 07/98→12/10							
 Bremskraftverstärker							
1.4 16V	55	08/00→12/10		05/01→ 06/10; +PR 1AC / 1AH / 1AJ / 1AT; für Linkslenker		03.7863-3502.4 300128	ATE Ø 10" pneumatisch
1.6	75	09/00→12/10					
1.9 TDI	74	08/00→12/10					
1.6	55 - 74	07/98→12/07		→ 07/00; für Linkslenker; + ESP		03.7863-0402.4 300124	ATE Ø 10" pneumatisch
1.9 SDI	50	07/98→12/03		05/01→; +PR 1AC / 1AH / 1AJ / 1AT; für Linkslenker		03.7863-3502.4 300128	ATE Ø 10" pneumatisch
1.9 TDI	66 - 81	07/98→03/10					
1.9 TDI 4x4	66	11/99→02/06					
2.0	85	04/99→05/07					
1.8 20V	92	07/98→07/00		für Linkslenker; + ESP		03.7863-0402.4 300124	ATE Ø 10" pneumatisch
1.8 T	110	07/98→12/10		→ 07/00; für Linkslenker; + ESP		03.7863-0402.4 300124	ATE Ø 10" pneumatisch
→							

	kw					! #		
SKODA - OCTAVIA I Combi (1U5) 07/98→12/10								
 Bremskraftverstärker								
1.8 T	110	07/98→12/10		05/01→06/10; +PR 1AC / 1AH / 1AJ / 1AT; für Linkslenker		03.7863-3502.4	300128	ATE Ø 10" pneumatisch
1.8 T 4x4 RS 1.8 T	110 132	05/01→05/06 08/02→01/06		+PR 1AC / 1AH / 1AJ / 1AT; für Linkslenker		03.7863-3502.4	300128	ATE Ø 10" pneumatisch
1.9 TDI	96	09/02→09/04		01/03→; +PR 1AC / 1AH / 1AJ / 1AT; für Linkslenker		03.7863-3502.4	300128	ATE Ø 10" pneumatisch
1.9 TDI 4x4 2.0 4x4	74 85	09/00→01/06 08/00→09/04		05/01→; +PR 1AC / 1AH / 1AJ / 1AT; für Linkslenker		03.7863-3502.4	300128	ATE Ø 10" pneumatisch
 Hauptbremszylinder								
1.4 16V 1.6 1.9 TDI	55 75 74	08/00→12/10 09/00→12/10 08/00→12/10		für Linkslenker; → 06/10; +PR 1AT		03.2123-2715.3	010802	ATE Ø 23,8
				für Rechtslenker; → 06/10; +PR 1AT		03.2123-2774.3	010803	ATE Ø 23,8
				für Linkslenker; → 06/10; +PR 1AC / 1AH / 1AJ		03.2123-2973.3	010951	ATE Ø 23,8
				für Linkslenker; → 06/10; +PR 1AM		24.2123-1709.3	010503	Ø 23,8
1.6 1.9 SDI 1.9 TDI	55 - 74 50	07/98→12/07 07/98→12/03 07/98→03/10		→ 07/00; für Linkslenker; + ESP		03.2123-2024.3	010597	ATE Ø 23,8
				08/00→; für Linkslenker; +PR 1AT		03.2123-2715.3	010802	ATE Ø 23,8
				08/00→; für Rechtslenker; +PR 1AT		03.2123-2774.3	010803	ATE Ø 23,8
1.9 TDI 4x4 2.0	66 - 81 66 85	07/98→03/10 11/99→02/06 04/99→05/07		08/00→; für Linkslenker; +PR 1AC / 1AH / 1AJ		03.2123-2973.3	010951	ATE Ø 23,8
				08/00→; für Linkslenker; +PR 1AM		24.2123-1709.3	010503	Ø 23,8
				→ 07/00; für Linkslenker; - ESP		24.2123-1709.3	010503	Ø 23,8
1.8 20V	92	07/98→07/00		für Linkslenker; + ESP		03.2123-2024.3	010597	ATE Ø 23,8
				für Linkslenker; - ESP		24.2123-1709.3	010503	Ø 23,8
1.8 T	110	07/98→12/10		→ 07/00; für Linkslenker; + ESP		03.2123-2024.3	010597	ATE Ø 23,8
				08/00→06/10; für Linkslenker; +PR 1AT		03.2123-2715.3	010802	ATE Ø 23,8
				08/00→06/10; für Rechtslenker; +PR 1AT		03.2123-2774.3	010803	ATE Ø 23,8
				08/00→06/10; für Linkslenker; +PR 1AC / 1AH / 1AJ		03.2123-2973.3	010951	ATE Ø 23,8
				08/00→06/10; für Linkslenker; +PR 1AM		24.2123-1709.3	010503	Ø 23,8
				→ 07/00; für Linkslenker; - ESP		24.2123-1709.3	010503	Ø 23,8
1.8 T 4x4 1.9 TDI 4x4 RS 1.8 T	110 74 132	05/01→05/06 09/00→01/06 08/02→01/06		für Linkslenker; +PR 1AT		03.2123-2715.3	010802	ATE Ø 23,8
				für Rechtslenker; +PR 1AT		03.2123-2774.3	010803	ATE Ø 23,8
				für Linkslenker; +PR 1AC / 1AH / 1AJ		03.2123-2973.3	010951	ATE Ø 23,8
				für Linkslenker; +PR 1AM		24.2123-1709.3	010503	Ø 23,8
1.9 TDI	96	09/02→09/04		01/03→; für Linkslenker; +PR 1AT		03.2123-2715.3	010802	ATE Ø 23,8
				01/03→; für Rechtslenker; +PR 1AT		03.2123-2774.3	010803	ATE Ø 23,8
				01/03→; für Linkslenker; +PR 1AC / 1AH / 1AJ		03.2123-2973.3	010951	ATE Ø 23,8
				01/03→; für Linkslenker; +PR 1AM		24.2123-1709.3	010503	Ø 23,8
2.0 4x4	85	08/00→09/04		05/01→; für Linkslenker; +PR 1AT		03.2123-2715.3	010802	ATE Ø 23,8
				05/01→; für Rechtslenker; +PR 1AT		03.2123-2774.3	010803	ATE Ø 23,8
				05/01→; für Linkslenker; +PR 1AC / 1AH / 1AJ		03.2123-2973.3	010951	ATE Ø 23,8
				05/01→; für Linkslenker; +PR 1AM		24.2123-1709.3	010503	Ø 23,8
 Bremskraftregler								
1.4 16V 1.6	55 75	08/00→12/10 09/00→12/10		→ 06/10; Trommelbremse		03.6584-0107.3	320110	ATE lastabhängig 8/4 4x
1.6 1.9 SDI 1.9 TDI	55 - 74 50 66	07/98→12/07 07/98→12/03 07/98→03/10		Trommelbremse		03.6584-0107.3	320110	ATE lastabhängig 8/4 4x
SKODA - OCTAVIA I Kasten/Kombi (1U5) 08/00→03/10								
 Bremskraftverstärker								
1.9 D 1.9 TDI	50 66	08/00→12/03 08/00→03/10		für Linkslenker; + ESP		03.7863-0402.4	300124	ATE Ø 10" pneumatisch
				05/01→; +PR 1AC / 1AH / 1AJ / 1AT; für Linkslenker		03.7863-3502.4	300128	ATE Ø 10" pneumatisch
 Hauptbremszylinder								
1.9 D 1.9 TDI	50 66	08/00→12/03 08/00→03/10		für Linkslenker; + ESP		03.2123-2024.3	010597	ATE Ø 23,8
				für Linkslenker; +PR 1AT		03.2123-2715.3	010802	ATE Ø 23,8
				für Rechtslenker; +PR 1AT		03.2123-2774.3	010803	ATE Ø 23,8
				für Linkslenker; +PR 1AC / 1AH / 1AJ		03.2123-2973.3	010951	ATE Ø 23,8
				für Linkslenker; - ESP		24.2123-1709.3	010503	Ø 23,8

	kw					! #		
SKODA - OCTAVIA I Kasten/Kombi (1U5) 08/00→03/10								
 Hauptbremszylinder								
1.9 D 1.9 TDI	50 66	08/00→12/03 08/00→03/10		für Linkslenker; +PR 1AM		24.2123-1709.3	010503	Ø 23,8
 Bremskraftregler								
1.9 D 1.9 TDI	50 66	08/00→12/03 08/00→03/10		Trommelbremse		03.6584-0107.3	320110	ATE lastabhängig 8/4 4x
SKODA - OCTAVIA II (1Z3) 02/04→06/13								
 Bremskraftverstärker								
1.2 TSI 1.4 1.4 TSI 1.6 1.6 TDI 1.8 TSI 2.0 TDI 2.0 TFSI	77 59 90 75 77 112 - 118 81 147	02/10→06/13 06/04→04/13 11/08→06/13 06/04→06/13 06/09→04/13 06/07→06/13 03/10→06/13 10/05→02/13		→ 01/13; für Linkslenker; +PR 1AC / 1AT		03.7863-3232.4	300307	ATE Ø 10" pneumatisch
1.4 1.6 FSI 2.0 TDI	55 85 100	05/04→05/06 02/04→10/08 02/04→05/10		06/04→; für Linkslenker; +PR 1AC / 1AT		03.7863-3232.4	300307	ATE Ø 10" pneumatisch
1.6 LPG 1.6 MultiFuel	75 75	08/09→11/12 01/08→06/13		09/09→; für Linkslenker; +PR 1AC / 1AT		03.7863-3232.4	300307	ATE Ø 10" pneumatisch
1.9 TDI 2.0 FSI 2.0 TDI 2.0 TDI RS 2.0 TDI 16V	77 110 103 125 103	06/04→12/10 11/04→10/08 11/05→05/10 04/06→02/13 02/04→04/13		für Linkslenker; +PR 1AC / 1AT		03.7863-3232.4	300307	ATE Ø 10" pneumatisch
 Hauptbremszylinder								
1.2 TSI 1.4 1.4 TSI 1.6 1.6 TDI 1.8 TSI 2.0 TDI 2.0 TFSI	77 59 90 75 77 112 - 118 81 147	02/10→06/13 06/04→04/13 11/08→06/13 06/04→06/13 06/09→04/13 06/07→06/13 03/10→06/13 10/05→02/13		→ 01/13; für Linkslenker		03.2122-2129.3	010799	ATE Ø 22,2
1.4 1.6 FSI 2.0 TDI	55 85 100	05/04→05/06 02/04→10/08 02/04→05/10		06/04→; für Linkslenker		24.2122-1788.3	011145	FTE Ø 22,2 ohne Bremsflüssigkeitsbehälter
1.6 LPG 1.6 MultiFuel	75 75	08/09→11/12 01/08→06/13		06/04→; für Rechtslenker		24.2122-1981.3	011024	ATE Ø 22,2 ohne Bremsflüssigkeitsbehälter
1.9 TDI 2.0 FSI 2.0 TDI 2.0 TDI RS 2.0 TDI 16V	77 110 103 125 103	06/04→12/10 11/04→10/08 11/05→05/10 04/06→02/13 02/04→04/13		für Linkslenker		03.2122-2129.3	010799	ATE Ø 22,2
				für Rechtslenker		24.2122-1788.3	011145	FTE Ø 22,2 ohne Bremsflüssigkeitsbehälter
				06/04→; für Linkslenker		24.2122-1981.3	011024	ATE Ø 22,2 ohne Bremsflüssigkeitsbehälter
				06/04→; für Rechtslenker		03.2122-2129.3	010799	ATE Ø 22,2
						24.2122-1788.3	011145	FTE Ø 22,2 ohne Bremsflüssigkeitsbehälter
						24.2122-1981.3	011024	ATE Ø 22,2 ohne Bremsflüssigkeitsbehälter
						03.2122-2129.3	010799	ATE Ø 22,2
						24.2122-1788.3	011145	FTE Ø 22,2 ohne Bremsflüssigkeitsbehälter
						24.2122-1981.3	011024	ATE Ø 22,2 ohne Bremsflüssigkeitsbehälter
						03.2122-2129.3	010799	ATE Ø 22,2
						24.2122-1788.3	011145	FTE Ø 22,2 ohne Bremsflüssigkeitsbehälter
						24.2122-1981.3	011024	ATE Ø 22,2 ohne Bremsflüssigkeitsbehälter
						03.2122-2129.3	010799	ATE Ø 22,2
						24.2122-1788.3	011145	FTE Ø 22,2 ohne Bremsflüssigkeitsbehälter
						24.2122-1981.3	011024	ATE Ø 22,2 ohne Bremsflüssigkeitsbehälter
Drucksensor, Bremskraftverstärker								
1.2 TSI 1.4 1.4 TSI 1.6 1.6 TDI →	77 59 90 75 77	02/10→06/13 06/04→04/13 11/08→06/13 06/04→06/13 06/09→04/13		→ 01/13; für Linkslenker; +PR 1AS		03.0655-0101.2	370008	ATE

	kw			 	! #		
SKODA - OCTAVIA II (1Z3) 02/04→06/13							
Drucksensor, Bremskraftverstärker							
1.8 TSI	112 - 118	06/07→06/13		→ 01/13; für Linkslenker; +PR 1AS		03.0655-0101.2 370008	ATE
2.0 TDI	81	03/10→06/13					
2.0 TFSI	147	10/05→02/13					
1.4	55	05/04→05/06		06/04→; für Linkslenker; +PR 1AS		03.0655-0101.2 370008	ATE
1.6 FSI	85	02/04→10/08					
2.0 TDI	100	02/04→05/10					
1.6 LPG	75	08/09→11/12		09/09→; für Linkslenker; +PR 1AS		03.0655-0101.2 370008	ATE
1.6 MultiFuel	75	01/08→06/13		09/09→ 01/13; für Linkslenker; +PR 1AS		03.0655-0101.2 370008	ATE
1.9 TDI	77	06/04→12/10		für Linkslenker; +PR 1AS		03.0655-0101.2 370008	ATE
2.0 FSI	110	11/04→10/08					
2.0 TDI	103	11/05→05/10					
2.0 TDI RS	125	04/06→02/13					
2.0 TDI 16V	103	02/04→04/13		06/04→ 01/13; für Linkslenker; +PR 1AS		03.0655-0101.2 370008	ATE
SKODA - OCTAVIA II Combi (1Z5) 02/04→06/13							
	Bremskraftverstärker						
1.2 TSI	77	02/10→04/13		→ 01/13; für Linkslenker; +PR 1AC / 1AT		03.7863-3232.4 300307	ATE Ø 10" pneumatisch
1.4	59	05/06→06/13					
1.4 TSI	90	11/08→06/13					
1.6	75	09/04→06/13					
1.6 TDI	77	06/09→04/13					
1.6 TDI 4x4	77	06/09→02/13					
1.8 TSI	112 - 118	06/07→06/13					
1.8 TSI 4x4	112 - 118	11/08→02/13					
2.0 TDI	81	03/10→06/13					
2.0 TDI 16V 4x4	103	05/10→02/13					
2.0 TDI 4x4	81	05/11→02/13					
2.0 TFSI	147	10/05→02/13					
1.4	55	05/04→05/06		06/04→; für Linkslenker; +PR 1AC / 1AT		03.7863-3232.4 300307	ATE Ø 10" pneumatisch
1.6 FSI	85	02/04→10/08					
2.0 TDI 16V	100	02/04→05/10					
1.6 LPG	75	08/09→11/12		09/09→; für Linkslenker; +PR 1AC / 1AT		03.7863-3232.4 300307	ATE Ø 10" pneumatisch
1.6 MultiFuel	75	01/08→06/13		09/09→ 01/13; für Linkslenker; +PR 1AC / 1AT		03.7863-3232.4 300307	ATE Ø 10" pneumatisch
1.9 TDI	77	09/04→12/10		für Linkslenker; +PR 1AC / 1AT		03.7863-3232.4 300307	ATE Ø 10" pneumatisch
1.9 TDI 4x4	77	11/04→12/10					
2.0 FSI	110	11/04→10/08					
2.0 FSI 4x4	110	11/04→04/09					
2.0 TDI	103	11/05→05/10					
2.0 TDI 4x4	103	07/06→05/10					
2.0 TDI RS	125	04/06→02/13					
2.0 TDI 16V	103	02/04→05/13		06/04→ 01/13; für Linkslenker; +PR 1AC / 1AT		03.7863-3232.4 300307	ATE Ø 10" pneumatisch
	Hauptbremszylinder						
1.2 TSI	77	02/10→04/13		→ 01/13; für Linkslenker		03.2122-2129.3 010799	ATE Ø 22,2
1.4	59	05/06→06/13					
1.4 TSI	90	11/08→06/13				24.2122-1788.3 011145	FTE Ø 22,2 ohne Bremsflüssigkeitsbehälter
1.6	75	09/04→06/13					
1.6 TDI	77	06/09→04/13		→ 01/13; für Rechtslenker		24.2122-1981.3 011024	ATE Ø 22,2 ohne Bremsflüssigkeitsbehälter
1.6 TDI 4x4	77	06/09→02/13					
1.8 TSI	112 - 118	06/07→06/13					
1.8 TSI 4x4	112 - 118	11/08→02/13					
2.0 TDI	81	03/10→06/13					
2.0 TDI 16V 4x4	103	05/10→02/13					
2.0 TDI 4x4	81	05/11→02/13					
2.0 TFSI	147	10/05→02/13					
1.4	55	05/04→05/06		06/04→; für Linkslenker		03.2122-2129.3 010799	ATE Ø 22,2
1.6 FSI	85	02/04→10/08				24.2122-1788.3 011145	FTE Ø 22,2 ohne Bremsflüssigkeitsbehälter
2.0 TDI 16V	100	02/04→05/10		06/04→; für Rechtslenker		24.2122-1981.3 011024	ATE Ø 22,2 ohne Bremsflüssigkeitsbehälter
1.6 LPG	75	08/09→11/12		09/09→; für Linkslenker		03.2122-2129.3 010799	ATE Ø 22,2
						24.2122-1788.3 011145	FTE Ø 22,2 ohne Bremsflüssigkeitsbehälter
				09/09→; für Rechtslenker		24.2122-1981.3 011024	ATE Ø 22,2 ohne Bremsflüssigkeitsbehälter
1.6 MultiFuel	75	01/08→06/13		09/09→ 01/13; für Linkslenker		03.2122-2129.3 010799	ATE Ø 22,2
						24.2122-1788.3 011145	FTE Ø 22,2 ohne Bremsflüssigkeitsbehälter
→							

SKODA - OCTAVIA II Combi (1Z5) 02/04→06/13

 **Hauptbremszylinder**

1.6 MultiFuel	75	01/08→06/13		09/09→ 01/13; für Rechtslenker	24.2122-1981.3	011024	ATE Ø 22,2 ohne Bremsflüssigkeitsbehälter
1.9 TDI	77	09/04→12/10		für Linkslenker	03.2122-2129.3	010799	ATE Ø 22,2
1.9 TDI 4x4	77	11/04→12/10			24.2122-1788.3	011145	FTE Ø 22,2 ohne Bremsflüssigkeitsbehälter
2.0 FSI	110	11/04→10/08					
2.0 FSI 4x4	110	11/04→04/09					
2.0 TDI	103	11/05→05/10		für Rechtslenker	24.2122-1981.3	011024	ATE Ø 22,2 ohne Bremsflüssigkeitsbehälter
2.0 TDI 4x4	103	07/06→05/10					
2.0 TDI RS	125	04/06→02/13					
2.0 TDI 16V	103	02/04→05/13		06/04→ 01/13; für Linkslenker	03.2122-2129.3	010799	ATE Ø 22,2
					24.2122-1788.3	011145	FTE Ø 22,2 ohne Bremsflüssigkeitsbehälter
				06/04→ 01/13; für Rechtslenker	24.2122-1981.3	011024	ATE Ø 22,2 ohne Bremsflüssigkeitsbehälter











Drucksensor, Bremskraftverstärker













1.2 TSI	77	02/10→04/13		→ 01/13; für Linkslenker; +PR 1AS	03.0655-0101.2	370008	ATE
1.4	59	05/06→06/13					
1.4 TSI	90	11/08→06/13					
1.6	75	09/04→06/13					
1.6 TDI	77	06/09→04/13					
1.6 TDI 4x4	77	06/09→02/13					
1.8 TSI	112 - 118	06/07→06/13					
1.8 TSI 4x4	112 - 118	11/08→02/13					
2.0 TDI	81	03/10→06/13					
2.0 TDI 16V 4x4	103	05/10→02/13					
2.0 TDI 4x4	81	05/11→02/13					
2.0 TFSI	147	10/05→02/13					
1.4	55	05/04→05/06		06/04→; für Linkslenker; +PR 1AS	03.0655-0101.2	370008	ATE
1.6 FSI	85	02/04→10/08					
2.0 TDI 16V	100	02/04→05/10					
1.6 LPG	75	08/09→11/12		09/09→; für Linkslenker; +PR 1AS	03.0655-0101.2	370008	ATE
1.6 MultiFuel	75	01/08→06/13		09/09→ 01/13; für Linkslenker; +PR 1AS	03.0655-0101.2	370008	ATE
1.9 TDI	77	09/04→12/10		für Linkslenker; +PR 1AS	03.0655-0101.2	370008	ATE
1.9 TDI 4x4	77	11/04→12/10					
2.0 FSI	110	11/04→10/08					
2.0 FSI 4x4	110	11/04→04/09					
2.0 TDI	103	11/05→05/10					
2.0 TDI 4x4	103	07/06→05/10					
2.0 TDI RS	125	04/06→02/13					
2.0 TDI 16V	103	02/04→05/13		06/04→ 01/13; für Linkslenker; +PR 1AS	03.0655-0101.2	370008	ATE

SKODA - OCTAVIA III (5E3, NL3, NR3) 11/12→03/21





 **Hauptbremszylinder**













1.0 TSI	85	05/16→10/20		für Linkslenker; +PR 1ZA / 1ZB / 1ZE / 1ZF	03.4153-5403.3	010994	ATE Ø 23,8
1.2 TSI	81	05/15→02/17			24.4123-1719.3	011017	TRW Ø 23,8 ohne Bremsflüssigkeitsbehälter
1.5 TSI	110	02/17→10/20					
1.6	81	01/14→10/20			24.4153-1522.3	011048	ATE Ø 23,8 ohne Bremsflüssigkeitsbehälter
1.6 TDI	85	02/17→10/20					
1.6 TDI 4x4	77 - 85	05/13→10/20					
1.8 TSI 4x4	132	05/14→10/20					
2.0 TDI 4x4	110	05/13→10/20					
2.0 TSI	140	02/17→10/20					
2.0 TSI 4x4	140	02/19→10/20					
2.0 TSI RS	169 - 180	05/15→10/20					
1.2 TSI	63 - 77	11/12→02/17		02/13→; für Linkslenker; +PR 1ZA / 1ZB / 1ZE / 1ZF	03.4153-5403.3	010994	ATE Ø 23,8
1.6 TDI	66 - 77	11/12→10/20			24.4123-1719.3	011017	TRW Ø 23,8 ohne Bremsflüssigkeitsbehälter
2.0 TDI	110	11/12→10/20		01/14→; für Linkslenker; +PR 1ZA / 1ZB / 1ZE / 1ZF	24.4153-1522.3	011048	ATE Ø 23,8 ohne Bremsflüssigkeitsbehälter
1.4 TSI	103	11/12→02/17		für Linkslenker; +PR 1ZA / 1ZB / 1ZE / 1ZF	03.4153-5403.3	010994	ATE Ø 23,8
1.4 TSI G-TEC	81	11/13→02/17			24.4123-1719.3	011017	TRW Ø 23,8 ohne Bremsflüssigkeitsbehälter
1.6 TDI	81	05/13→02/17					
1.8 TSI	132	11/12→10/20			24.4153-1522.3	011048	ATE Ø 23,8 ohne Bremsflüssigkeitsbehälter
2.0 TDI	105	11/12→02/17		01/14→; für Linkslenker; +PR 1ZA / 1ZB / 1ZE / 1ZF	24.4153-1522.3	011048	ATE Ø 23,8 ohne Bremsflüssigkeitsbehälter
2.0 TDI RS	135	05/13→10/20					
2.0 TSI RS	162	05/13→02/17					
1.4 TSI	110	08/14→10/20		05/15→; für Linkslenker; +PR 1ZA / 1ZB / 1ZE / 1ZF	03.4153-5403.3	010994	ATE Ø 23,8
				+PR 1ZA / 1ZB / 1ZE / 1ZF; für Linkslenker	24.4153-1522.3	011048	ATE Ø 23,8 ohne Bremsflüssigkeitsbehälter
→							















	kw					! #		
SKODA - OCTAVIA III (5E3, NL3, NR3) 11/12→03/21								
 Hauptbremszylinder								
2.0 TDI / TDI RS 4x4	135	05/13→10/20		für Linkslenker; +PR 1ZA / 1ZB / 1ZE / 1ZF		03.4153-5403.3 010994 24.4123-1719.3 011017	ATE Ø 23,8 TRW Ø 23,8 ohne Bremsflüssigkeitsbehälter	
				09/14→; +PR 1ZA / 1ZB / 1ZE / 1ZF; für Linkslenker		24.4153-1522.3 011048	ATE Ø 23,8 ohne Bremsflüssigkeitsbehälter	
SKODA - OCTAVIA III Combi (5E5, 5E6) 11/12→10/20								
 Hauptbremszylinder								
1.0 TSI	85	05/16→10/20		für Linkslenker; +PR 1ZA / 1ZB / 1ZE / 1ZF		03.4153-5403.3 010994 24.4123-1719.3 011017	ATE Ø 23,8 TRW Ø 23,8 ohne Bremsflüssigkeitsbehälter	
1.2 TSI	81	05/15→02/17						
1.5 TSI	110	02/17→10/20						
1.5 TSI G-TEC	96	01/19→10/20						
1.6 SRE	81	01/14→02/17				24.4153-1522.3 011048	ATE Ø 23,8 ohne Bremsflüssigkeitsbehälter	
1.6 TDI	85	02/17→10/20						
1.6 TDI 4x4	81 - 85	05/15→10/20						
2.0 TDI / TDI RS 4x4	135	05/13→10/20						
2.0 TSI	140	02/17→10/20						
2.0 TSI 4x4	140	02/19→10/20						
2.0 TSI RS	169 - 180	05/15→10/20						
1.2 TSI	63 - 77	11/12→02/17		02/13→; für Linkslenker; +PR 1ZA / 1ZB / 1ZE / 1ZF		03.4153-5403.3 010994 24.4123-1719.3 011017	ATE Ø 23,8 TRW Ø 23,8 ohne Bremsflüssigkeitsbehälter	
1.6 TDI	66 - 77	11/12→10/20						
2.0 TDI	110	11/12→10/20		01/14→; für Linkslenker; +PR 1ZA / 1ZB / 1ZE / 1ZF		24.4153-1522.3 011048	ATE Ø 23,8 ohne Bremsflüssigkeitsbehälter	
1.4 TSI	103	11/12→02/17		für Linkslenker; +PR 1ZA / 1ZB / 1ZE / 1ZF		03.4153-5403.3 010994 24.4123-1719.3 011017	ATE Ø 23,8 TRW Ø 23,8 ohne Bremsflüssigkeitsbehälter	
1.4 TSI G-TEC	81	11/12→02/17						
1.6 TDI	81	05/13→02/17						
1.6 TDI 4x4	77	11/12→05/15						
1.8 TSI	132	11/12→10/20		01/14→; für Linkslenker; +PR 1ZA / 1ZB / 1ZE / 1ZF		24.4153-1522.3 011048	ATE Ø 23,8 ohne Bremsflüssigkeitsbehälter	
1.8 TSI 4x4	132	11/12→02/17						
2.0 TDI	105	11/12→02/17						
2.0 TDI 4x4	110	11/12→10/20						
2.0 TDI RS	135	05/13→10/20						
1.4 TSI	110	08/14→10/20		05/15→; für Linkslenker; +PR 1ZA / 1ZB / 1ZE / 1ZF		03.4153-5403.3 010994 24.4123-1719.3 011017	ATE Ø 23,8 TRW Ø 23,8 ohne Bremsflüssigkeitsbehälter	
				+PR 1ZA / 1ZB / 1ZE / 1ZF; für Linkslenker		24.4153-1522.3 011048	ATE Ø 23,8 ohne Bremsflüssigkeitsbehälter	
2.0 TSI RS	162	11/12→02/17		05/13→; +PR 1ZA / 1ZB / 1ZE / 1ZF; für Linkslenker		03.4153-5403.3 010994 24.4123-1719.3 011017	ATE Ø 23,8 TRW Ø 23,8 ohne Bremsflüssigkeitsbehälter	
				01/14→; für Linkslenker; +PR 1ZA / 1ZB / 1ZE / 1ZF		24.4153-1522.3 011048	ATE Ø 23,8 ohne Bremsflüssigkeitsbehälter	
SKODA - ROOMSTER (5J7) 03/06→05/15								
 Hauptbremszylinder								
1.2	47	05/06→01/07		07/06→; für Linkslenker; + ABS		24.2120-1734.3 010702	Ø 20,6	
				07/06→; für Linkslenker; - ABS		24.2120-1736.3 010732	Ø 20,6	
				07/06→; für Rechtslenker		24.2120-1768.3 011041	Ø 20,6 ohne Bremsflüssigkeitsbehälter	
1.2	51	01/07→05/15		→ 12/10; für Linkslenker; + ABS		24.2120-1734.3 010702	Ø 20,6	
1.2 LPG	51	03/09→05/15						
1.2 TDI	55	03/10→05/15		→ 12/10; für Linkslenker; - ABS		24.2120-1736.3 010732	Ø 20,6	
1.2 TSI	63 - 77	03/10→05/15		→ 12/10; für Rechtslenker		24.2120-1768.3 011041	Ø 20,6 ohne Bremsflüssigkeitsbehälter	
1.4	63	09/06→05/15						
1.4 LPG	63	03/10→05/15						
1.6	77	09/06→05/15						
1.6 TDI	66 - 77	03/10→05/15						
1.4 TDI	51 - 59	07/06→03/10		für Linkslenker; + ABS		24.2120-1734.3 010702	Ø 20,6	
1.6 LPG	77	06/06→07/10		für Linkslenker; - ABS		24.2120-1736.3 010732	Ø 20,6	
1.9 TDI	77	09/06→03/10		für Rechtslenker		24.2120-1768.3 011041	Ø 20,6 ohne Bremsflüssigkeitsbehälter	
 Bremskraftregler								
1.2	47	05/06→01/07		07/06→; - ABS		03.6584-0107.3 320110	ATE lastabhängig 8/4 4x	
1.2	51	01/07→05/15		→ 04/15; - ABS		03.6584-0107.3 320110	ATE lastabhängig 8/4 4x	
1.2 LPG	51	03/09→05/15						
1.2 TDI	55	03/10→05/15						
→								















	kw					! #		
SKODA - ROOMSTER (5J7) 03/06→05/15								
 Bremskraftregler								
1.2 TSI	63 - 77	03/10→05/15		→ 04/15; - ABS			03.6584-0107.3 320110	ATE lastabhängig 8/4 4x
1.4	63	09/06→05/15						
1.4 LPG	63	03/10→05/15						
1.6	77	09/06→05/15						
1.6 TDI	66 - 77	03/10→05/15						
1.4 TDI	51 - 59	07/06→03/10		- ABS			03.6584-0107.3 320110	ATE lastabhängig 8/4 4x
1.6 LPG	77	06/06→07/10						
1.9 TDI	77	09/06→03/10						
SKODA - ROOMSTER Praktik (5J) 03/07→05/15								
 Hauptbremszylinder								
1.2	51	03/07→05/15		→ 12/10; für Linkslenker; + ABS			24.2120-1734.3 010702	Ø 20,6
1.2 TDI	55	03/10→05/15						
1.2 TSI	63	03/10→05/15		→ 12/10; für Linkslenker; - ABS			24.2120-1736.3 010732	Ø 20,6
1.4	63	03/07→05/15		für Rechtslenker; → 12/10			24.2120-1768.3 011041	Ø 20,6 ohne Bremsflüssigkeitsbehälter
1.6 TDI	66	03/10→05/15						
1.4 TDI	51 - 59	03/07→03/10		für Linkslenker; + ABS			24.2120-1734.3 010702	Ø 20,6
				für Linkslenker; - ABS			24.2120-1736.3 010732	Ø 20,6
				für Rechtslenker			24.2120-1768.3 011041	Ø 20,6 ohne Bremsflüssigkeitsbehälter
 Bremskraftregler								
1.2	51	03/07→05/15		→ 04/15; - ABS			03.6584-0107.3 320110	ATE lastabhängig 8/4 4x
1.2 TDI	55	03/10→05/15						
1.2 TSI	63	03/10→05/15						
1.4	63	03/07→05/15						
1.6 TDI	66	03/10→05/15						
1.4 TDI	51 - 59	03/07→03/10		- ABS			03.6584-0107.3 320110	ATE lastabhängig 8/4 4x
SKODA - SCALA (NW1) 02/19→								
 Hauptbremszylinder								
1.0 TGI CNG	66	11/19→		für Linkslenker; +PR 1ZS / 1ZE			24.2123-1782.3 011146	TRW Ø 23,8 ohne Bremsflüssigkeitsbehälter
1.0 TSI	70 - 85	02/19→						
1.5 TSI	110	02/19→						
1.6 SRE	81	02/19→						
1.6 TDI	70 - 85	02/19→						
SKODA - SUPERB I (3U4) 12/01→03/08								
 Hauptbremszylinder								
1.8 T	110	12/01→03/08		→ 02/08			03.2125-0373.3 010810	ATE Ø 25,4
2.0	85	12/01→03/08					24.2125-1720.3 010688	TRW Ø 25,4
1.9 TDI	74 - 77	08/02→05/07					03.2125-0373.3 010810	ATE Ø 25,4
2.0 TDI	91	02/06→03/08					24.2125-1720.3 010688	TRW Ø 25,4
2.5 TDI	114	12/01→08/03						
1.9 TDI	85 - 96	12/01→03/08		→ 12/07			03.2125-0373.3 010810	ATE Ø 25,4
2.0 TDI	103	10/05→03/08					24.2125-1720.3 010688	TRW Ø 25,4
2.5 TDI	120	06/03→03/08						
2.8 V6	140 - 142	12/01→03/08						
SKODA - SUPERB II (3T4) 03/08→05/15								
 Bremskraftverstärker								
1.4 TSI	92	07/08→05/15		08/08→ 02/15; für Rechtslenker			03.7848-9802.4 300344	ATE Ø 7 / 8" pneumatisch
1.8 TSI	118	03/08→05/15						
2.0 TDI	125	07/08→05/15		08/08→ 02/15; für Linkslenker			03.7863-3332.4 300308	ATE Ø 10" pneumatisch
1.6 TDI	77	09/10→05/15		→ 02/15; für Rechtslenker			03.7848-9802.4 300344	ATE Ø 7 / 8" pneumatisch
1.8 TSI	112	03/09→05/15						
1.8 TSI 4x4	112 - 118	11/08→05/15		→ 02/15; für Linkslenker			03.7863-3332.4 300308	ATE Ø 10" pneumatisch
2.0 TDI 16V	103	01/09→05/15						
2.0 TDI 16V 4x4	103	11/10→05/15						
2.0 TFSI	147	05/10→05/15						
3.6 FSI 4x4	191	11/08→05/15						
1.9 TDI	77	03/08→11/10		08/08→; für Rechtslenker			03.7848-9802.4 300344	ATE Ø 7 / 8" pneumatisch
2.0 TDI	103	03/08→05/10		08/08→; für Linkslenker			03.7863-3332.4 300308	ATE Ø 10" pneumatisch
2.0 TDI 4x4	125	09/08→05/15		10/08→ 02/15; für Rechtslenker			03.7848-9802.4 300344	ATE Ø 7 / 8" pneumatisch
→								





























	kw			 	! #		
SKODA - SUPERB II (3T4) 03/08→05/15							
 Bremskraftverstärker							
2.0 TDI 4x4	125	09/08→05/15		10/08→02/15; für Linkslenker		03.7863-3332.4 300308	ATE Ø 10" pneumatisch
 Hauptbremszylinder							
1.4 TSI	92	07/08→05/15		08/08→02/15; für Linkslenker		03.2123-3449.3 010808	ATE Ø 23,8
1.8 TSI	118	03/08→05/15					
2.0 TDI	125	07/08→05/15		08/08→02/15; für Rechtslenker		24.4153-0202.3 011027	ATE Ø 23,8 ohne Bremsflüssigkeitsbehälter
1.6 TDI	77	09/10→05/15		→02/15; für Linkslenker		03.2123-3449.3 010808	ATE Ø 23,8
1.8 TSI	112	03/09→05/15					
1.8 TSI 4x4	112 - 118	11/08→05/15		→02/15; für Rechtslenker		24.4153-0202.3 011027	ATE Ø 23,8 ohne Bremsflüssigkeitsbehälter
2.0 TDI 16V	103	01/09→05/15					
2.0 TDI 16V 4x4	103	11/10→05/15					
2.0 TFSI	147	05/10→05/15					
3.6 FSI 4x4	191	11/08→05/15					
1.9 TDI	77	03/08→11/10		08/08→; für Linkslenker		03.2123-3449.3 010808	ATE Ø 23,8
2.0 TDI	103	03/08→05/10		08/08→; für Rechtslenker		24.4153-0202.3 011027	ATE Ø 23,8 ohne Bremsflüssigkeitsbehälter
2.0 TDI 4x4	125	09/08→05/15		10/08→02/15; für Linkslenker		03.2123-3449.3 010808	ATE Ø 23,8
				10/08→02/15; für Rechtslenker		24.4153-0202.3 011027	ATE Ø 23,8 ohne Bremsflüssigkeitsbehälter
SKODA - SUPERB II Kombi (3T5) 10/09→05/15							
 Bremskraftverstärker							
1.4 TSI	92	10/09→05/15		11/09→02/15; für Rechtslenker		03.7848-9802.4 300344	ATE Ø 7 / 8" pneumatisch
1.8 TSI	112 - 118	10/09→05/15		11/09→02/15; für Linkslenker		03.7863-3332.4 300308	ATE Ø 10" pneumatisch
1.8 TSI 4x4	112 - 118	10/09→05/15					
2.0 TDI	125	10/09→05/15					
2.0 TDI 16V	103	10/09→05/15					
2.0 TDI 4x4	125	10/09→05/15					
3.6 V6 4x4	191	10/09→05/15					
1.6 TDI	77	09/10→05/15		→02/15; für Rechtslenker		03.7848-9802.4 300344	ATE Ø 7 / 8" pneumatisch
2.0 TDI 16V 4x4	103	11/10→05/15		→02/15; für Linkslenker		03.7863-3332.4 300308	ATE Ø 10" pneumatisch
2.0 TFSI	147	05/10→05/15					
1.9 TDI	77	10/09→11/10		für Rechtslenker		03.7848-9802.4 300344	ATE Ø 7 / 8" pneumatisch
				für Linkslenker		03.7863-3332.4 300308	ATE Ø 10" pneumatisch
2.0 TDI	103	10/09→03/10		11/09→; für Rechtslenker		03.7848-9802.4 300344	ATE Ø 7 / 8" pneumatisch
				11/09→; für Linkslenker		03.7863-3332.4 300308	ATE Ø 10" pneumatisch
 Hauptbremszylinder							
1.4 TSI	92	10/09→05/15		11/09→02/15; für Linkslenker		03.2123-3449.3 010808	ATE Ø 23,8
1.8 TSI	112 - 118	10/09→05/15		11/09→02/15; für Rechtslenker		24.4153-0202.3 011027	ATE Ø 23,8 ohne Bremsflüssigkeitsbehälter
1.8 TSI 4x4	112 - 118	10/09→05/15					
2.0 TDI	125	10/09→05/15					
2.0 TDI 16V	103	10/09→05/15					
2.0 TDI 4x4	125	10/09→05/15					
3.6 V6 4x4	191	10/09→05/15					
1.6 TDI	77	09/10→05/15		→02/15; für Linkslenker		03.2123-3449.3 010808	ATE Ø 23,8
2.0 TDI 16V 4x4	103	11/10→05/15		→02/15; für Rechtslenker		24.4153-0202.3 011027	ATE Ø 23,8 ohne Bremsflüssigkeitsbehälter
2.0 TFSI	147	05/10→05/15					
1.9 TDI	77	10/09→11/10		für Linkslenker		03.2123-3449.3 010808	ATE Ø 23,8
				für Rechtslenker		24.4153-0202.3 011027	ATE Ø 23,8 ohne Bremsflüssigkeitsbehälter
2.0 TDI	103	10/09→03/10		11/09→; für Linkslenker		03.2123-3449.3 010808	ATE Ø 23,8
				11/09→; für Rechtslenker		24.4153-0202.3 011027	ATE Ø 23,8 ohne Bremsflüssigkeitsbehälter
SKODA - SUPERB III (3V3) 03/15→							
 Hauptbremszylinder							
1.4 TSI	92 - 110	03/15→		für Linkslenker		24.4123-1719.3 011017	TRW Ø 23,8 ohne Bremsflüssigkeitsbehälter
1.4 TSI 4x4	110	03/15→				24.4153-1522.3 011048	ATE Ø 23,8 ohne Bremsflüssigkeitsbehälter
1.5 TSI	110	02/17→					
1.6 TDI	88	03/15→					
1.8 TSI	132	03/15→					
2.0 TDI	110 - 147	03/15→					
2.0 TDI 4x4	110 - 147	03/15→					
2.0 TSI	162	03/15→					
→							





	kw					! #		
SKODA - SUPERB III (3V3) 03/15→								
 Hauptbremszylinder								
2.0 TSI 4x4	200 - 206	03/15→			für Linkslenker		24.4123-1719.3 011017 24.4153-1522.3 011048	TRW Ø 23,8 ohne Bremsflüssigkeitsbehälter ATE Ø 23,8 ohne Bremsflüssigkeitsbehälter
2.0 TDI 2.0 TSI	90 140	07/20→ 07/19→			für Linkslenker		24.4153-1522.3 011048	ATE Ø 23,8 ohne Bremsflüssigkeitsbehälter
SKODA - SUPERB III Kombi (3V5) 03/15→								
 Hauptbremszylinder								
1.4 TSI 1.4 TSI 4x4 1.5 TSi 1.6 TDI 1.8 TSI 2.0 TDI 2.0 TDI 4x4 2.0 TSI 2.0 TSI 4x4	92 - 110 110 110 88 132 110 - 147 110 - 147 162 200 - 206	03/15→ 03/15→ 02/17→ 03/15→ 03/15→ 03/15→ 03/15→ 03/15→ 03/15→			für Linkslenker		24.4123-1719.3 011017 24.4153-1522.3 011048	TRW Ø 23,8 ohne Bremsflüssigkeitsbehälter ATE Ø 23,8 ohne Bremsflüssigkeitsbehälter
2.0 TDI 2.0 TSI	90 140	07/20→ 07/19→			für Linkslenker		24.4153-1522.3 011048	ATE Ø 23,8 ohne Bremsflüssigkeitsbehälter
SKODA - YETI (5L) 05/09→12/17								
 Bremskraftverstärker								
1.2 TSI 1.4 TSI 1.4 TSI 4x4 1.6 1.6 TDI 1.8 TSI 4x4 2.0 TDI 2.0 TDI 4x4	77 - 81 90 - 92 110 81 77 112 - 118 81 - 110 81 - 125	09/09→12/17 06/10→12/17 05/15→12/17 04/14→12/17 11/10→05/15 05/09→12/17 11/09→12/17 05/09→12/17			für Rechtslenker; +PR 1AT / 1ZA / 1ZE / 1LK für Linkslenker; +PR 1AC / 1AS / 1AT / 1ZE / 1ZF für Linkslenker; +PR 1AT / 1ZA / 1ZE / 1LK		03.7848-9802.4 300344 03.7863-3232.4 300307 03.7863-3332.4 300308	ATE Ø 7 / 8" pneumatisch ATE Ø 10" pneumatisch ATE Ø 10" pneumatisch
 Hauptbremszylinder								
1.2 TSI 1.4 TSI 1.4 TSI 4x4 1.6 1.6 TDI 1.8 TSI 4x4 2.0 TDI 2.0 TDI 4x4	77 - 81 90 - 92 110 81 77 112 - 118 81 - 110 81 - 125	09/09→12/17 06/10→12/17 05/15→12/17 04/14→12/17 11/10→05/15 05/09→12/17 11/09→12/17 05/09→12/17			für Linkslenker; +PR 1ZE / 1ZF für Linkslenker; +PR 1ZA für Rechtslenker; +PR 1ZE / 1ZF für Rechtslenker; +PR 1ZA		03.2122-2129.3 010799 03.2123-3449.3 010808 24.4152-0132.3 011025 24.4153-0202.3 011027	ATE Ø 22,2 ATE Ø 23,8 ATE Ø 22,2 ohne Bremsflüssigkeitsbehälter ATE Ø 23,8 ohne Bremsflüssigkeitsbehälter
SMART - CITY-COUPÉ (450) 07/98→01/04								
 Hauptbremszylinder								
0.6 0.8 CDI	33 - 52 30	07/98→01/04 11/99→01/04			01/03→; für Linkslenker → 12/02; für Linkslenker; zusätzlich benötigter Artikel (Artikel-Nummer): Q0014462V001000000		24.2119-1711.3 010911 24.2119-1711.3 010911	Ø 19 ohne Bremsflüssigkeitsbehälter Ø 19 ohne Bremsflüssigkeitsbehälter
0.7	37 - 55	01/03→01/04			für Linkslenker		24.2119-1711.3 010911	Ø 19 ohne Bremsflüssigkeitsbehälter
SMART - CROSSBLADE (450) 06/02→12/03								
 Hauptbremszylinder								
0.6	52	06/02→12/03			01/03→; für Linkslenker → 12/02; für Linkslenker; zusätzlich benötigter Artikel (Artikel-Nummer): Q0014462V001000000		24.2119-1711.3 010911 24.2119-1711.3 010911	Ø 19 ohne Bremsflüssigkeitsbehälter Ø 19 ohne Bremsflüssigkeitsbehälter















	kw					! #		
SMART - FORFOUR (454) 01/04→06/06								
 Hauptbremszylinder								
1.1 1.3 1.5	55 70 80	01/04→06/06 01/04→06/06 01/04→06/06		03/04→; für Linkslenker			24.2122-1770.3 010898	TRW Ø 22,2
1.1 1.5 BRABUS 1.5 CDI	47 130 50 - 70	02/05→06/06 05/05→06/06 09/04→06/06		für Linkslenker			24.2122-1770.3 010898	TRW Ø 22,2
1.5	90	01/04→06/06		11/04→; für Linkslenker			24.2122-1770.3 010898	TRW Ø 22,2
SMART - FORFOUR Schrägheck (453) 07/14→								
 Hauptbremszylinder								
0.9	66	11/14→		Schaltgetriebe			24.4150-1071.3 011046	ATE Ø 20,6 ohne Bremsflüssigkeitsbehälter
0.9 Brabus electric drive / EQ electric drive	80 41 60	07/16→ 05/17→ 05/17→					24.4150-1071.3 011046	ATE Ø 20,6 ohne Bremsflüssigkeitsbehälter
1.0	45	11/14→		01/15→; Schaltgetriebe			24.4150-1071.3 011046	ATE Ø 20,6 ohne Bremsflüssigkeitsbehälter
1.0	52	07/14→		11/14→; Schaltgetriebe			24.4150-1071.3 011046	ATE Ø 20,6 ohne Bremsflüssigkeitsbehälter
SMART - FORTWO Cabrio (450) 01/04→01/07								
 Hauptbremszylinder								
0.6 0.6 Brabus 0.7 0.8 CDI	45 55 45 - 55 30	01/04→12/06 01/04→12/06 01/04→01/07 01/04→01/07 01/04→01/07		für Linkslenker			24.2119-1711.3 010911	Ø 19 ohne Bremsflüssigkeitsbehälter
SMART - FORTWO Cabrio (451) 01/07→								
 Hauptbremszylinder								
1.0	52	01/07→		K014181→; für Linkslenker			24.2123-1780.3 011081	Ø 23,8 ohne Bremsflüssigkeitsbehälter
SMART - FORTWO Cabriolet (453) 09/15→								
 Hauptbremszylinder								
0.9 0.9 Brabus 1.0 electric drive / EQ electric drive	66 80 52 41 60	09/15→ 07/16→ 09/15→ 05/17→ 05/17→					24.4150-1071.3 011046	ATE Ø 20,6 ohne Bremsflüssigkeitsbehälter
SMART - FORTWO Coupe (450) 01/04→02/07								
 Hauptbremszylinder								
0.6 0.7 0.8 CDI 0.8 D	45 45 30 33	01/04→02/07 01/04→01/07 01/04→01/07 09/04→12/06		→ J182805; für Linkslenker			24.2119-1711.3 010911	Ø 19 ohne Bremsflüssigkeitsbehälter
0.7	34 - 55	01/04→02/07		für Linkslenker			24.2119-1711.3 010911	Ø 19 ohne Bremsflüssigkeitsbehälter
0.7	40	01/04→01/07		→ J182808; für Linkslenker			24.2119-1711.3 010911	Ø 19 ohne Bremsflüssigkeitsbehälter
SMART - FORTWO Coupe (451) 01/07→								
 Hauptbremszylinder								
1.0	45 - 52	01/07→		K014181→; für Linkslenker			24.2123-1780.3 011081	Ø 23,8 ohne Bremsflüssigkeitsbehälter
SMART - FORTWO Coupe (453) 07/14→								
 Hauptbremszylinder								
0.9 1.0	66 52	09/14→ 07/14→		11/14→			24.4150-1071.3 011046	ATE Ø 20,6 ohne Bremsflüssigkeitsbehälter
0.9 Brabus electric drive / EQ electric drive	80 41 60	07/16→ 05/17→ 05/17→					24.4150-1071.3 011046	ATE Ø 20,6 ohne Bremsflüssigkeitsbehälter
1.0	45	11/14→		01/15→			24.4150-1071.3 011046	ATE Ø 20,6 ohne Bremsflüssigkeitsbehälter















	kw					! #		
SUBARU - JUSTY III (G3X) 09/03→								
 Hauptbremszylinder								
1.3 AWD	69	09/03→			→ 08/07		24.2120-1730.3 010678	Ø 20,6
1.5 AWD	73	09/03→						
1.3 CDTi	51	12/03→08/07			für Linkslenker		24.2120-1730.3 010678	Ø 20,6
SUZUKI - IGNIS II (MH) 08/03→								
 Hauptbremszylinder								
1.3	69	09/03→			→ 12/12; + ABS		24.2120-1730.3 010678	Ø 20,6
1.3 4x4	69	09/03→						
1.3 DDiS	51	09/03→						
1.5	73	09/03→						
1.5 4x4	73	09/03→						
SUZUKI - JIMNY Geländewagen geschlossen (SN) 07/98→								
 Hauptbremszylinder								
1.3	63	08/04→			- ABS		24.2122-1776.3 011001	Ø 22,2 ohne Bremsflüssigkeitsbehälter
1.3 16V	60	02/01→						
1.3 16V 4WD	60	02/01→						
1.3 16V 4x4	63	08/05→						
1.3 4WD	62	05/14→						
1.3 4x4	63	09/98→08/00						
1.5 DDiS 4WD	48	12/03→						
1.5 DDiS 4x4	63	08/05→						
SUZUKI - JIMNY Geländewagen offen (SN) 01/98→								
 Hauptbremszylinder								
1.3	63	08/04→			- ABS		24.2122-1776.3 011001	Ø 22,2 ohne Bremsflüssigkeitsbehälter
1.3 4WD	63	03/13→						
SUZUKI - SPLASH (EX) 01/08→								
 Hauptbremszylinder								
1.0	48 - 50	01/08→			für Linkslenker; - ESP		24.4122-1718.3 011019	BOS Ø 22,2 ohne Bremsflüssigkeitsbehälter
1.2	63	01/08→			für Linkslenker; + ESP		24.4122-1719.3 011020	Ø 22,2 ohne Bremsflüssigkeitsbehälter
1.2 LPG	63	04/08→12/14						
1.2 VVT	66 - 69	09/10→						
1.3 CDTI	55	01/08→						
SUZUKI - SWIFT III (MZ, EZ) 02/05→								
 Hauptbremszylinder								
1.2	66	04/08→12/10			für Linkslenker; - ESP		24.4122-1718.3 011019	BOS Ø 22,2 ohne Bremsflüssigkeitsbehälter
1.3	67	02/05→06/15						
1.3 4x4	66 - 68	02/05→			für Linkslenker; + ESP		24.4122-1719.3 011020	Ø 22,2 ohne Bremsflüssigkeitsbehälter
1.3 DDiS	51 - 55	08/05→						
1.5	75	02/05→						
1.5 4x4	74	02/05→						
1.6	92	05/06→						
1.3	68	02/05→			→ 09/10; für Linkslenker; - ESP		24.4122-1718.3 011019	BOS Ø 22,2 ohne Bremsflüssigkeitsbehälter
					→ 09/10; für Linkslenker; + ESP		24.4122-1719.3 011020	Ø 22,2 ohne Bremsflüssigkeitsbehälter
1.3 LPG	68	09/08→12/10			- ESP		24.4122-1718.3 011019	BOS Ø 22,2 ohne Bremsflüssigkeitsbehälter
					+ ESP		24.4122-1719.3 011020	Ø 22,2 ohne Bremsflüssigkeitsbehälter
SUZUKI - SX4 (EY, GY) 06/06→								
 Hauptbremszylinder								
1.5	73	06/06→07/10			- ESP; Fahrzeugproduktionsland Ungarn		24.4122-1712.3 010899	BOS Ø 22,2 ohne Bremsflüssigkeitsbehälter
1.5 VVT	82	07/10→						
1.5 VVTi	81	07/07→12/15			+ ESP; Fahrzeugproduktionsland Ungarn		24.4122-1713.3 010900	BOS Ø 22,2 ohne Bremsflüssigkeitsbehälter
1.6 LPG	79	06/06→12/12						
1.6 VVT	79 - 88	06/06→						
1.6 VVT 4x4	79 - 88	06/06→						
1.5 VVT 4x4	82	07/10→			- ESP		24.4122-1712.3 010899	BOS Ø 22,2 ohne Bremsflüssigkeitsbehälter
1.6 DDiS	66	04/07→						
1.9 DDiS	88	06/06→			+ ESP		24.4122-1713.3 010900	BOS Ø 22,2 ohne Bremsflüssigkeitsbehälter
1.9 DDiS 4x4	88	06/06→						
2.0 16V 4x4	112	01/10→						
2.0 DDiS	99	07/09→						
2.0 DDiS 4x4	99	07/09→						















	kw					! #		
SUZUKI - SX4 Stufenheck (GY, RW) 10/07→								
 Hauptbremszylinder								
1.6	79 - 88	10/07→		- ESP; Fahrzeugproduktionsland Ungarn		24.4122-1712.3	010899	BOS Ø 22,2 ohne Bremsflüssigkeitsbehälter
				+ ESP; Fahrzeugproduktionsland Ungarn		24.4122-1713.3	010900	BOS Ø 22,2 ohne Bremsflüssigkeitsbehälter
SUZUKI - WAGON R Schrägheck (MH21, MH22) 03/02→12/12								
 Hauptbremszylinder								
1.0	39 - 44	07/03→08/05				24.2120-1730.3	010678	Ø 20,6
1.2	59	06/04→08/05						
1.3	65	09/03→12/10		+ ABS		24.2120-1730.3	010678	Ø 20,6
SUZUKI - WAGON R+ (MA) 05/99→								
 Hauptbremszylinder								
1.0	74	08/00→07/01				24.2120-1730.3	010678	Ø 20,6
1.2	59	01/05→12/08						
1.3	56 - 69	05/00→08/06		+ ABS		24.2120-1730.3	010678	Ø 20,6
1.3 4WD	56	10/01→		→ 12/04; + ABS		24.2120-1730.3	010678	Ø 20,6
1.3 4WD	69	09/03→		→ 04/08; + ABS		24.2120-1730.3	010678	Ø 20,6
1.3 DDiS	51	09/03→						
TOYOTA - AURIS (E15) 10/06→09/12								
 Hauptbremszylinder								
1.33 Dual-VVTi	73 - 74	05/09→09/12		für Fahrzeuge mit Start-Stopp-Funktion; Fahrzeugproduktionsland Japan		24.4122-1728.3	011103	Ø 22,2 ohne Bremsflüssigkeitsbehälter
1.4	71	03/07→09/12		+ ESP; Fahrzeugproduktionsland Japan		24.4122-1728.3	011103	Ø 22,2 ohne Bremsflüssigkeitsbehälter
1.6	91 - 97	03/07→09/12						
1.8	100 - 108	10/06→09/12						
1.8 4WD	100	10/06→10/09		02/09→; + ESP; Fahrzeugproduktionsland Japan		24.4122-1728.3	011103	Ø 22,2 ohne Bremsflüssigkeitsbehälter
TOYOTA - AVENSIS (T25) 03/03→11/08								
 Hauptbremszylinder								
1.6 VVT-i	81	04/03→11/08		+ ESP		24.2123-1771.3	010857	BOS Ø 23,8 ohne Bremsflüssigkeitsbehälter
1.8 VVT-i	95	03/03→10/08						
2.0 D-4D	85 - 93	04/03→11/08						
2.0 VVT-i	108	03/03→11/08						
2.0 VVTi	114	03/03→10/08						
2.2 D-4D	110	10/05→11/08						
2.2 D-CAT	130	07/05→11/08						
2.4 VVT-i	120 - 125	09/03→11/08						
TOYOTA - AVENSIS Kombi (T25) 04/03→11/08								
 Hauptbremszylinder								
1.6 VVT-i	81	04/03→11/08		+ ESP		24.2123-1771.3	010857	BOS Ø 23,8 ohne Bremsflüssigkeitsbehälter
2.0 D-4D	85 - 93	04/03→11/08						
2.0 VVT-i	108 - 114	04/03→11/08						
2.2 D-4D	110	10/05→11/08						
2.2 D-CAT	130	07/05→11/08						
2.4 VVT-i	120 - 125	09/03→11/08						
1.8 VVT-i	95	04/03→11/08		+ ESP; 02/04→		24.2123-1771.3	010857	BOS Ø 23,8 ohne Bremsflüssigkeitsbehälter
TOYOTA - AVENSIS Kombi (T27) 11/08→10/18								
 Hauptbremszylinder								
1.6 D4-D	82	04/15→10/18		für Linkslenker		24.4123-1732.3	011101	Ø 23,8 ohne Bremsflüssigkeitsbehälter
1.8 VVT-i	108	11/08→10/18						
2.0 D-4D	91 - 105	11/08→10/18						
2.0 VVT-i	112	11/08→10/18						
2.2 D-4D	110 - 130	11/08→10/18						
1.6 VVT-i	97	11/08→10/18		+ ESP; für Linkslenker		24.4123-1732.3	011101	Ø 23,8 ohne Bremsflüssigkeitsbehälter











	kw					! #		
TOYOTA - AVENSIS Stufenheck (_T25_) 01/03→11/08								
 Hauptbremszylinder								
1.6 VVT-i 2.0 D-4D	81 85 - 93	04/03→11/08 04/03→11/08		+ ESP			24.2123-1771.3 010857	BOS Ø 23,8 ohne Bremsflüssigkeitsbehälter
2.0 VVT-i 2.0 VVTi 2.2 D-4D 2.2 D-CAT 2.4 VVT-i	108 114 110 130 120 - 125	04/03→11/08 01/03→11/08 10/05→11/08 07/05→11/08 09/03→11/08						
1.8 VVT-i	95	04/03→11/08		+ ESP; 02/04→			24.2123-1771.3 010857	BOS Ø 23,8 ohne Bremsflüssigkeitsbehälter
TOYOTA - AVENSIS Stufenheck (_T27_) 11/08→10/18								
 Hauptbremszylinder								
1.6 D4-D 1.8 VVT-i 2.0 D-4D	82 108 91 - 105	04/15→10/18 11/08→10/18 11/08→10/18		für Linkslenker			24.4123-1732.3 011101	Ø 23,8 ohne Bremsflüssigkeitsbehälter
2.0 VVT-i 2.2 D-4D	112 110 - 130	11/08→10/18 11/08→10/18						
1.6 VVT-i 2.0 VVT-i	97 100	11/08→10/18 11/08→04/11		+ ESP; für Linkslenker			24.4123-1732.3 011101	Ø 23,8 ohne Bremsflüssigkeitsbehälter
TOYOTA - AYGO (_B1_) 02/05→05/14								
 Hauptbremszylinder								
1.0 1.0 GPL 1.4 D-4D	50 50 40	07/05→05/14 07/05→05/14 07/05→08/10		- ESP; für Linkslenker			24.4120-1701.3 010846	BOS Ø 20,6
				+ ESP; für Linkslenker			24.4120-1704.3 011042	Ø 20,6 ohne Bremsflüssigkeitsbehälter
				+ ESP; für Rechtslenker			24.4120-1705.3 011051	Ø 20,6 ohne Bremsflüssigkeitsbehälter
TOYOTA - AYGO (_B4_) 05/14→								
 Hauptbremszylinder								
1.0	51	05/14→		+ ESP			24.4120-1708.3 011084	Ø 20,6 ohne Bremsflüssigkeitsbehälter
				- ESP			24.4120-1712.3 011092	Ø 20,6 ohne Bremsflüssigkeitsbehälter
1.0 VVTi	53	03/18→		für Linkslenker; + ESP			24.4120-1708.3 011084	Ø 20,6 ohne Bremsflüssigkeitsbehälter
				für Linkslenker; - ESP			24.4120-1712.3 011092	Ø 20,6 ohne Bremsflüssigkeitsbehälter
1.2	60	05/14→		für Linkslenker			24.4120-1708.3 011084	Ø 20,6 ohne Bremsflüssigkeitsbehälter
TOYOTA - AYGO Kasten/Schrägheck (_B1_) 07/05→05/14								
 Hauptbremszylinder								
1.0 VVTi	50	07/05→05/14		- ESP; für Linkslenker			24.4120-1701.3 010846	BOS Ø 20,6
				+ ESP; für Linkslenker			24.4120-1704.3 011042	Ø 20,6 ohne Bremsflüssigkeitsbehälter
				+ ESP; für Rechtslenker			24.4120-1705.3 011051	Ø 20,6 ohne Bremsflüssigkeitsbehälter
TOYOTA - COROLLA (_E12_) 01/01→04/08								
 Hauptbremszylinder								
1.4 D	66	07/04→02/07		→ 10/06; - ESP			24.2120-1749.3 010903	TRW Ø 20,6
				→ 10/06; + ESP			24.2120-1760.3 011018	Ø 20,6 ohne Bremsflüssigkeitsbehälter
1.4 VVT-i 1.6 VVT-i 2.0 D-4D	71 81 85	11/01→02/07 01/02→12/06 05/03→02/07		06/04→ 10/06; - ESP			24.2120-1749.3 010903	TRW Ø 20,6
				→ 05/04; - ESP			24.2120-1749.3 010903	TRW Ø 20,6
				06/04→ 10/06; + ESP			24.2120-1760.3 011018	Ø 20,6 ohne Bremsflüssigkeitsbehälter
				→ 05/04; + ESP			24.2120-1760.3 011018	Ø 20,6 ohne Bremsflüssigkeitsbehälter
1.8 VVTL-i TS	160 - 165	02/05→02/07		→ 10/06; + ESP			24.2120-1760.3 011018	Ø 20,6 ohne Bremsflüssigkeitsbehälter
1.8 VVTL-i TS	141	11/01→02/07		→ 05/04; + ESP			24.2120-1760.3 011018	Ø 20,6 ohne Bremsflüssigkeitsbehälter
2.0 D-4D	66 - 81	01/02→12/06		→ 05/04; - ESP			24.2120-1749.3 010903	TRW Ø 20,6
→								











	kw					! #		
TOYOTA - COROLLA (_E12_) 01/01→04/08								
 Hauptbremszylinder								
2.0 D-4D	66 - 81	01/02→12/06			→ 05/04; + ESP		24.2120-1760.3 011018	Ø 20,6 ohne Bremsflüssigkeitsbehälter
TOYOTA - COROLLA Kombi (_E12_) 03/01→12/08								
 Hauptbremszylinder								
1.3 1.4 VVT-i 1.5	65	09/02→08/07			06/04→; - ESP		24.2120-1749.3 010903	TRW Ø 20,6
	71	01/02→02/07			→ 05/04; - ESP		24.2120-1749.3 010903	TRW Ø 20,6
	81	03/01→09/06			06/04→; + ESP		24.2120-1760.3 011018	Ø 20,6 ohne Bremsflüssigkeitsbehälter
					→ 05/04; + ESP		24.2120-1760.3 011018	Ø 20,6 ohne Bremsflüssigkeitsbehälter
1.4 D4-D	66	06/04→10/07			→ 10/06; - ESP		24.2120-1749.3 010903	TRW Ø 20,6
					→ 10/06; + ESP		24.2120-1760.3 011018	Ø 20,6 ohne Bremsflüssigkeitsbehälter
1.6 VVT-i 2.0 D-4D	81	01/02→08/07			06/04→ 10/06; - ESP		24.2120-1749.3 010903	TRW Ø 20,6
			85	04/04→02/07			→ 05/04; - ESP	
					06/04→ 10/06; + ESP		24.2120-1760.3 011018	Ø 20,6 ohne Bremsflüssigkeitsbehälter
					→ 05/04; + ESP		24.2120-1760.3 011018	Ø 20,6 ohne Bremsflüssigkeitsbehälter
1.8	100	12/01→12/07			→ 10/06; + ESP		24.2120-1760.3 011018	Ø 20,6 ohne Bremsflüssigkeitsbehälter
2.0 D-4D	66	01/02→02/07			→ 05/04; - ESP		24.2120-1749.3 010903	TRW Ø 20,6
					→ 05/04; + ESP		24.2120-1760.3 011018	Ø 20,6 ohne Bremsflüssigkeitsbehälter
TOYOTA - COROLLA Stufenheck (_E12_) 08/00→12/08								
 Hauptbremszylinder								
1.3 1.4 D-4D 1.8	65	08/00→05/04			- ESP		24.2120-1749.3 010903	TRW Ø 20,6
	66	06/04→10/06			+ ESP		24.2120-1760.3 011018	Ø 20,6 ohne Bremsflüssigkeitsbehälter
	92 - 100	11/01→10/06						
1.4 VVT-i 1.5	71 80	10/01→10/06 11/01→07/07			06/04→; - ESP		24.2120-1749.3 010903	TRW Ø 20,6
					→ 05/04; - ESP		24.2120-1749.3 010903	TRW Ø 20,6
					06/04→; + ESP		24.2120-1760.3 011018	Ø 20,6 ohne Bremsflüssigkeitsbehälter
				→ 05/04; + ESP		24.2120-1760.3 011018	Ø 20,6 ohne Bremsflüssigkeitsbehälter	
1.6 VVT-i	81	10/01→03/08			01/02→ 05/04; - ESP		24.2120-1749.3 010903	TRW Ø 20,6
					06/04→ 10/06; - ESP		24.2120-1749.3 010903	TRW Ø 20,6
					06/04→ 10/06; + ESP		24.2120-1760.3 011018	Ø 20,6 ohne Bremsflüssigkeitsbehälter
					01/02→ 05/04; + ESP		24.2120-1760.3 011018	Ø 20,6 ohne Bremsflüssigkeitsbehälter
1.8	96	03/01→07/05			01/02→ 05/04; - ESP		24.2120-1749.3 010903	TRW Ø 20,6
					01/02→ 05/04; + ESP		24.2120-1760.3 011018	Ø 20,6 ohne Bremsflüssigkeitsbehälter
2.0 D-4D	66	01/02→12/06			05/03→ 05/04; - ESP		24.2120-1749.3 010903	TRW Ø 20,6
					→ 05/04; - ESP		24.2120-1749.3 010903	TRW Ø 20,6
					05/03→ 05/04; + ESP		24.2120-1760.3 011018	Ø 20,6 ohne Bremsflüssigkeitsbehälter
					→ 05/04; + ESP		24.2120-1760.3 011018	Ø 20,6 ohne Bremsflüssigkeitsbehälter
2.0 D-4D	85	06/04→07/07			→ 10/06; - ESP		24.2120-1749.3 010903	TRW Ø 20,6
					→ 10/06; + ESP		24.2120-1760.3 011018	Ø 20,6 ohne Bremsflüssigkeitsbehälter
TOYOTA - COROLLA Stufenheck (_E15_) 10/06→12/18								
 Hauptbremszylinder								
1.3	74	12/08→07/14			→ 05/13; + ESP		24.4122-1728.3 011103	Ø 22,2 ohne Bremsflüssigkeitsbehälter
1.4 VVT-i 1.6 Dual VVTi 1.6 VVTi	71	11/06→11/13			→ 12/08; + ESP		24.4122-1728.3 011103	Ø 22,2 ohne Bremsflüssigkeitsbehälter
	91	01/07→07/14						
	81	08/07→06/13						
1.6	97	11/06→11/13			01/09→ 05/13; + ESP		24.4122-1728.3 011103	Ø 22,2 ohne Bremsflüssigkeitsbehälter
→								

	kw					! #		
TOYOTA - COROLLA Stufenheck (_E15_) 10/06→12/18								
 Hauptbremszylinder								
1.6 VVTi	90 - 100	03/07→05/14		+ ESP		24.4122-1728.3	011103	Ø 22,2 ohne Bremsflüssigkeitsbehälter
1.8	97 - 99	12/07→07/14						
1.8 VVTi	97	01/08→07/14						
1.8	100	10/06→07/14		11/06→12/08; + ESP		24.4122-1728.3	011103	Ø 22,2 ohne Bremsflüssigkeitsbehälter
TOYOTA - COROLLA Stufenheck (_E18_, ZRE1_) 06/13→02/21								
 Hauptbremszylinder								
1.6	89 - 97	06/13→12/18		- ESP		24.4122-1728.3	011103	Ø 22,2 ohne Bremsflüssigkeitsbehälter
1.6 CNG	92	11/17→12/18						
1.6 VVTi	92	11/17→12/18						
1.8 VVTi	103	06/13→08/19						
TOYOTA - COROLLA Verso (_E12_) 07/01→05/07								
 Hauptbremszylinder								
1.6 VVT-i	81	08/01→05/04				24.2120-1749.3	010903	TRW Ø 20,6
2.0 D-4D	66	01/02→05/04						
TOYOTA - COROLLA Verso (ZER_, ZZE12_, R1_) 03/04→10/09								
 Hauptbremszylinder								
1.6	81	04/04→03/09		09/05→; + ESP		24.2123-1771.3	010857	BOS Ø 23,8 ohne Bremsflüssigkeitsbehälter
1.8	95	04/04→03/09						
2.0 D-4D	85	04/04→03/09		05/04→08/05; + ESP		24.2123-1771.3	010857	BOS Ø 23,8 ohne Bremsflüssigkeitsbehälter
2.2 D-4D	100 - 130	10/05→03/09		+ ESP		24.2123-1771.3	010857	BOS Ø 23,8 ohne Bremsflüssigkeitsbehälter
TOYOTA - RAV 4 II (_A2_) 05/00→11/05								
 Hauptbremszylinder								
1.8	92	08/00→11/05		02/01→07/03; Schaltgetriebe		24.2120-1757.3	010976	Ø 20,6 ohne Bremsflüssigkeitsbehälter
				02/01→07/03; Automatikgetriebe		24.2120-1757.3	010976	Ø 20,6 ohne Bremsflüssigkeitsbehälter
2.0	110	09/00→12/03		→07/03; Schaltgetriebe		24.2120-1757.3	010976	Ø 20,6 ohne Bremsflüssigkeitsbehälter
2.0 4WD	110	05/00→11/05		→07/03; Automatikgetriebe		24.2120-1757.3	010976	Ø 20,6 ohne Bremsflüssigkeitsbehälter
2.0 D 4WD	85	05/01→11/05		09/01→07/03; Schaltgetriebe		24.2120-1757.3	010976	Ø 20,6 ohne Bremsflüssigkeitsbehälter
				09/01→07/03; Automatikgetriebe		24.2120-1757.3	010976	Ø 20,6 ohne Bremsflüssigkeitsbehälter
TOYOTA - RAV 4 III (_A3_) 06/05→08/14								
 Hauptbremszylinder								
2.0 4WD	109 - 116	02/06→06/13		Automatikgetriebe; + ESP; für Linkslenker		24.4122-1730.3	011105	Ø 22,2 ohne Bremsflüssigkeitsbehälter
2.2 D 4WD	110	12/08→06/13		Automatikgetriebe; für Linkslenker		24.4122-1730.3	011105	Ø 22,2 ohne Bremsflüssigkeitsbehälter
2.4	125	11/05→12/13		Automatikgetriebe; + ESP		24.4122-1730.3	011105	Ø 22,2 ohne Bremsflüssigkeitsbehälter
2.4 4WD	125	11/05→06/13						
2.5	132	11/08→06/13		→06/09		24.4122-1730.3	011105	Ø 22,2 ohne Bremsflüssigkeitsbehälter
2.5 4WD	132	11/08→06/13		+ ESP		24.4122-1730.3	011105	Ø 22,2 ohne Bremsflüssigkeitsbehälter
TOYOTA - RAV 4 IV (_A4_) 12/12→09/19								
 Hauptbremszylinder								
2.0	107	12/12→09/19		für Linkslenker; Automatikgetriebe		24.4122-1730.3	011105	Ø 22,2 ohne Bremsflüssigkeitsbehälter
2.0 4WD	111	12/12→10/18						
2.5	131	01/13→12/18						
2.5 4WD	131	12/12→12/18						
2.0 4WD	112	04/15→10/18		+ ESP		24.4122-1730.3	011105	Ø 22,2 ohne Bremsflüssigkeitsbehälter
2.0 4WD	107	12/12→09/19		für Linkslenker		24.4122-1730.3	011105	Ø 22,2 ohne Bremsflüssigkeitsbehälter
2.2 D 4WD	110	12/12→09/19		Automatikgetriebe		24.4122-1730.3	011105	Ø 22,2 ohne Bremsflüssigkeitsbehälter
→								

	kw					! #		
TOYOTA - RAV 4 IV (_A4_) 12/12→09/19								
 Hauptbremszylinder								
2.5	132	12/12→11/18				24.4122-1730.3	011105	Ø 22,2 ohne Bremsflüssigkeitsbehälter
2.5 4WD	132	12/12→10/18						
TOYOTA - RAV 4 IV VAN (_A4_) 12/12→								
 Hauptbremszylinder								
2.0 VVTi 4WD	111	12/12→11/18			für Linkslenker; Automatikgetriebe	24.4122-1730.3	011105	Ø 22,2 ohne Bremsflüssigkeitsbehälter
2.0 VVTi 4WD	112	12/12→11/18			04/15→; für Linkslenker; Automatikgetriebe	24.4122-1730.3	011105	Ø 22,2 ohne Bremsflüssigkeitsbehälter
2.2 D4d 4WD	110	12/12→11/18			Automatikgetriebe	24.4122-1730.3	011105	Ø 22,2 ohne Bremsflüssigkeitsbehälter
TOYOTA - YARIS / VIOS Stufenheck (_P9_) 08/05→12/13								
 Bremskraftverstärker								
1.5	80	01/06→12/13			für Linkslenker; + ESP	03.7750-7132.4	300255	ATE Ø 9" pneumatisch
 Hauptbremszylinder								
1.5	80	01/06→12/13			- ESP	03.4152-0153.3	011006	ATE Ø 22,2 ohne Bremsflüssigkeitsbehälter
					+ ESP	03.4152-0158.3	011007	ATE Ø 22,2 ohne Bremsflüssigkeitsbehälter
TOYOTA - YARIS (_P1_) 01/99→12/05								
 Hauptbremszylinder								
1.0	48	03/03→09/05			04/03→ 08/05; Fahrzeugproduktionsland Frankreich	24.2120-1766.3	011000	Ø 20,6 ohne Bremsflüssigkeitsbehälter
1.3	64	04/02→09/05			→ 08/05; Fahrzeugproduktionsland Frankreich	24.2120-1766.3	011000	Ø 20,6 ohne Bremsflüssigkeitsbehälter
1.4 D-4D	55	10/01→09/05			12/01→ 08/05; Fahrzeugproduktionsland Frankreich	24.2120-1766.3	011000	Ø 20,6 ohne Bremsflüssigkeitsbehälter
TOYOTA - YARIS (_P9_) 01/05→12/14								
 Bremskraftverstärker								
1.0 GPL	51	01/06→12/11			für Linkslenker; Fahrzeugproduktionsland Frankreich; + ESP	03.7750-7132.4	300255	ATE Ø 9" pneumatisch
1.0 VVT-i	51 - 52	08/05→12/11						
1.33 VVT-i	73 - 74	11/08→12/11			für Linkslenker; + ESP	03.7750-7132.4	300255	ATE Ø 9" pneumatisch
1.3 4WD	64	01/05→11/10						
1.3 VVT-i	63 - 64	08/05→12/12						
1.4 D-4D	66	08/05→12/12						
1.5	80 - 81	01/05→12/14						
 Hauptbremszylinder								
1.0 GPL	51	01/06→12/11			Fahrzeugproduktionsland Frankreich; - ESP	03.4152-0153.3	011006	ATE Ø 22,2 ohne Bremsflüssigkeitsbehälter
1.0 VVT-i	51 - 52	08/05→12/11			Fahrzeugproduktionsland Frankreich; + ESP	03.4152-0158.3	011007	ATE Ø 22,2 ohne Bremsflüssigkeitsbehälter
1.33 VVT-i	73 - 74	11/08→12/11			- ESP	03.4152-0153.3	011006	ATE Ø 22,2 ohne Bremsflüssigkeitsbehälter
1.3 4WD	64	01/05→11/10			+ ESP	03.4152-0158.3	011007	ATE Ø 22,2 ohne Bremsflüssigkeitsbehälter
1.3 VVT-i	64	08/05→11/10						
1.4 D-4D	66	08/05→12/12						
1.5	80 - 81	01/05→12/14						
1.3 VVT-i	63	11/05→12/12			01/06→ 08/11; - ESP	03.4152-0153.3	011006	ATE Ø 22,2 ohne Bremsflüssigkeitsbehälter
					+ ESP	03.4152-0158.3	011007	ATE Ø 22,2 ohne Bremsflüssigkeitsbehälter
TOYOTA - YARIS (_P13_) 12/10→06/20								
 Hauptbremszylinder								
1.0	51	12/10→06/20			für Linkslenker; Fahrzeugproduktionsland Frankreich; + ESP	24.2122-1785.3	011114	Ø 22,2 ohne Bremsflüssigkeitsbehälter
1.3	63 - 73	12/10→03/17						
1.3 4WD	70	12/10→01/20			für Linkslenker; Fahrzeugproduktionsland Frankreich	24.2122-1786.3	011115	Ø 22,2 ohne Bremsflüssigkeitsbehälter
1.5	80	12/10→01/20						
1.0	53	06/18→06/20			für Linkslenker; + ESP	24.2122-1785.3	011114	Ø 22,2 ohne Bremsflüssigkeitsbehälter
1.4 D	66	09/11→05/18						
→								

	kw					! #		
TOYOTA - YARIS (_P13_) 12/10→06/20								
 Hauptbremszylinder								
1.5	82	03/17→06/20		für Linkslenker		24.2122-1786.3	011115	Ø 22,2 ohne Bremsflüssigkeitsbehälter
1.8 GRMN	156	09/17→06/20		für Linkslenker		24.2122-1785.3	011114	Ø 22,2 ohne Bremsflüssigkeitsbehälter
TOYOTA - YARIS Kasten/Schrägheck (_P13_) 10/12→06/20								
 Hauptbremszylinder								
1.0 VVTi 1.3 VVTi	51 73	07/14→06/20 10/12→03/17		für Linkslenker; Fahrzeugproduktionsland Frankreich; + ESP		24.2122-1785.3	011114	Ø 22,2 ohne Bremsflüssigkeitsbehälter
				für Linkslenker; Fahrzeugproduktionsland Frankreich		24.2122-1786.3	011115	Ø 22,2 ohne Bremsflüssigkeitsbehälter
1.0 VVTi 1.4 D4d	53 66	06/18→06/20 07/14→05/18		+ ESP; für Linkslenker		24.2122-1785.3	011114	Ø 22,2 ohne Bremsflüssigkeitsbehälter
				für Linkslenker		24.2122-1786.3	011115	Ø 22,2 ohne Bremsflüssigkeitsbehälter
1.5 VVTi	82	03/17→06/20		+ ESP		24.2122-1785.3	011114	Ø 22,2 ohne Bremsflüssigkeitsbehälter
				für Linkslenker		24.2122-1786.3	011115	Ø 22,2 ohne Bremsflüssigkeitsbehälter
VAUXHALL - ADAM (M13) 10/12→04/19								
 Hauptbremszylinder								
1.0 1.4 S	85 110	07/14→11/18 11/14→01/19		für Linkslenker; Trommelbremse		24.4122-1731.3	011100	Ø 22,2 ohne Bremsflüssigkeitsbehälter
				für Rechtslenker		24.4122-1737.3	011147	BOS Ø 22,2 ohne Bremsflüssigkeitsbehälter
				für Linkslenker; Scheibenbremse		24.4123-1722.3	011071	Ø 23,8 ohne Bremsflüssigkeitsbehälter
1.2 1.4	51 64 - 74	10/12→04/19 10/12→02/19		für Linkslenker; Trommelbremse		24.4122-1731.3	011100	Ø 22,2 ohne Bremsflüssigkeitsbehälter
				01/13→; für Rechtslenker		24.4122-1737.3	011147	BOS Ø 22,2 ohne Bremsflüssigkeitsbehälter
				01/13→; für Linkslenker; Scheibenbremse		24.4123-1722.3	011071	Ø 23,8 ohne Bremsflüssigkeitsbehälter
VAUXHALL - AGILA Mk I (A) (H00) 02/00→03/08								
 Hauptbremszylinder								
1.0 12V 1.2 16V Twinport	43 59	09/00→08/05 07/04→11/06		+ ABS		24.2120-1730.3	010678	Ø 20,6
1.0 12V 1.2 16V	44 55	02/00→11/06 09/00→03/08		09/00→; + ABS + ABS; → 07/07		24.2120-1730.3	010678	Ø 20,6
VAUXHALL - AGILA Mk II (B) (H08) 01/08→11/14								
 Hauptbremszylinder								
1.0 12V 1.0 i 1.2 i 16V	48 50 63 - 69	01/08→11/14 08/11→11/14 01/08→11/14		für Linkslenker; - ESP		24.4122-1718.3	011019	BOS Ø 22,2 ohne Bremsflüssigkeitsbehälter
1.3 CDTI	55	01/08→11/14		für Linkslenker; + ESP		24.4122-1719.3	011020	Ø 22,2 ohne Bremsflüssigkeitsbehälter
VAUXHALL - ASTRA Mk III (F) Cabriolet (T92) 09/91→03/01								
 Bremskraftregler								
1.6 i	55	01/96→03/01		→ R2500000		03.0101-0027.2	320022	ATE Satz 3/45 2x
VAUXHALL - ASTRA Mk IV (G) Cabriolet (T98) 03/01→10/05								
 Hauptbremszylinder								
1.6 16V	74 - 76	03/01→10/05		- ESP		24.2123-1734.3	010640	TRW Ø 23,8
1.8 16V 2.0 2.0 Turbo 2.2 16V	92 147 141 108	03/01→10/05 09/02→10/05 03/02→10/05 03/01→10/05		+ ESP		24.2123-1739.3	010661	Ø 23,8
VAUXHALL - ASTRA Mk IV (G) CC (T98) 02/98→05/05								
 Hauptbremszylinder								
1.4 16V 1.6 1.6 16V 1.6 Dualfuel	66 55 74 55	02/98→05/05 02/98→09/00 02/98→05/05 02/98→12/00		04/98→; - ESP; für Fahrzeuge mit Scheibenbremse an der Hinterachse		24.2123-1734.3	010640	TRW Ø 23,8
				22000001→; - ESP; für Fahrzeuge mit Trommelbremse an der Hinterachse		24.2123-1734.3	010640	TRW Ø 23,8
→								

	kW					! #		
VAUXHALL - ASTRA Mk IV (G) CC (T98) 02/98→05/05								
 Hauptbremszylinder								
1.4 16V	66	02/98→05/05		04/98→; + ESP		24.2123-1739.3	010661	Ø 23,8
1.6	55	02/98→09/00						
1.6 16V	74	02/98→05/05						
1.6 Dualfuel	55	02/98→12/00						
1.4 16V Dualfuel	66	09/99→06/03		- ESP; für Fahrzeuge mit Scheibenbremse an der Hinterachse		24.2123-1734.3	010640	TRW Ø 23,8
1.6	62	09/00→05/05						
1.6 Dualfuel	62 - 74	09/99→05/05		22000001→; - ESP; für Fahrzeuge mit Trommelbremse an der Hinterachse		24.2123-1734.3	010640	TRW Ø 23,8
1.7 DTI 16V	55	02/00→05/05		+ ESP		24.2123-1739.3	010661	Ø 23,8
1.6	76	12/02→05/05		- ESP		24.2123-1734.3	010640	TRW Ø 23,8
1.8 16V	92	09/00→05/05						
1.8 16V Dualfuel	87 - 92	07/02→05/05		+ ESP		24.2123-1739.3	010661	Ø 23,8
2.0	147	08/02→05/05						
2.0 DTI 16V	74	08/99→05/05						
2.0 SRI Turbo	141	11/01→05/05						
2.2 16V	108	03/01→05/05						
1.7 CDTI 16V	59	04/03→05/05		- ESP		24.2123-1734.3	010640	TRW Ø 23,8
1.7 TD	50	02/98→08/00		04/98→; - ESP; für Fahrzeuge mit Scheibenbremse an der Hinterachse		24.2123-1734.3	010640	TRW Ø 23,8
				04/98→; + ESP		24.2123-1739.3	010661	Ø 23,8
1.8 16V	85	02/98→09/00		04/98→; - ESP		24.2123-1734.3	010640	TRW Ø 23,8
2.0 16V	100	02/98→05/05						
2.0 DI	60	02/98→05/05		04/98→; + ESP		24.2123-1739.3	010661	Ø 23,8
VAUXHALL - ASTRA Mk IV (G) Coupe (T98) 03/00→08/05								
 Hauptbremszylinder								
1.6 16V	76	03/00→08/05		- ESP; für Fahrzeuge mit Scheibenbremse an der Hinterachse		24.2123-1734.3	010640	TRW Ø 23,8
				22000001→; - ESP; für Fahrzeuge mit Trommelbremse an der Hinterachse		24.2123-1734.3	010640	TRW Ø 23,8
				+ ESP		24.2123-1739.3	010661	Ø 23,8
1.8 16V	85 - 92	03/00→08/05		- ESP		24.2123-1734.3	010640	TRW Ø 23,8
1.8 16V Dualfuel	87 - 92	07/02→08/05		+ ESP		24.2123-1739.3	010661	Ø 23,8
2.0 16V Turbo	140	09/00→08/05						
2.2 16V	108	03/00→08/05		09/00→; - ESP		24.2123-1734.3	010640	TRW Ø 23,8
				09/00→; + ESP		24.2123-1739.3	010661	Ø 23,8
VAUXHALL - ASTRA Mk IV (G) Kombi (T98) 02/98→05/05								
 Hauptbremszylinder								
1.4 16V	66	02/98→05/05		04/98→; - ESP; für Fahrzeuge mit Scheibenbremse an der Hinterachse		24.2123-1734.3	010640	TRW Ø 23,8
1.6	55 - 62	03/98→04/04						
1.6 16V	74	03/98→04/04		22000001→; - ESP; für Fahrzeuge mit Trommelbremse an der Hinterachse		24.2123-1734.3	010640	TRW Ø 23,8
1.6 Dualfuel	63	03/98→04/04		04/98→; + ESP		24.2123-1739.3	010661	Ø 23,8
1.4 16V Dualfuel	66	09/99→06/03		- ESP; für Fahrzeuge mit Scheibenbremse an der Hinterachse		24.2123-1734.3	010640	TRW Ø 23,8
1.6	76	12/02→05/05						
1.6 Dualfuel	55 - 74	02/98→05/05		22000001→; - ESP; für Fahrzeuge mit Trommelbremse an der Hinterachse		24.2123-1734.3	010640	TRW Ø 23,8
1.7 DTI 16V	55	02/00→05/05		+ ESP		24.2123-1739.3	010661	Ø 23,8
1.7 CDTI 16V	59	04/03→05/05		- ESP		24.2123-1734.3	010640	TRW Ø 23,8
1.7 TD	50	02/98→08/00		04/98→; - ESP; für Fahrzeuge mit Scheibenbremse an der Hinterachse		24.2123-1734.3	010640	TRW Ø 23,8
				04/98→; + ESP		24.2123-1739.3	010661	Ø 23,8
1.8 16V	85	02/98→08/00		04/98→; - ESP		24.2123-1734.3	010640	TRW Ø 23,8
2.0 DI	60	03/98→04/04		04/98→; + ESP		24.2123-1739.3	010661	Ø 23,8
1.8 16V	92	09/00→05/05		- ESP		24.2123-1734.3	010640	TRW Ø 23,8
1.8 16V Dualfuel	87 - 92	07/02→05/05		+ ESP		24.2123-1739.3	010661	Ø 23,8
2.2 16V	108	03/01→05/05						
2.0 DTI 16V	74	03/98→04/04		08/99→; - ESP		24.2123-1734.3	010640	TRW Ø 23,8
				08/99→; + ESP		24.2123-1739.3	010661	Ø 23,8
 Bremskraftregler								
1.4 16V	66	02/98→05/05		04/98→; - ABS		03.6583-0073.3	320234	ATE lastabhängig 8/3 4x
1.6	55 - 62	03/98→04/04						
1.6 16V	74	03/98→04/04						
1.6 Dualfuel	63	03/98→04/04						
1.7 TD	50	02/98→08/00						
→								

	kw					! #		
VAUXHALL - ASTRA Mk IV (G) Kombi (T98) 02/98→05/05								
 Bremskraftregler								
1.8 16V	85	02/98→08/00		04/98→;	- ABS		03.6583-0073.3 320234	ATE lastabhängig 8/3 4x
1.4 16V Dualfuel	66	09/99→06/03			- ABS		03.6583-0073.3 320234	ATE lastabhängig 8/3 4x
1.6	76	12/02→05/05						
1.6 Dualfuel	55 -	02/98→08/04						
	74							
1.7 CDTI 16V	59	04/03→05/05						
1.7 DTI 16V	55	02/00→05/05						
1.8 16V	92	09/00→05/05						
1.8 16V Dualfuel	87 -	07/02→05/05						
	92							
VAUXHALL - ASTRA Mk IV (G) Stufenheck (T98) 02/98→05/05								
 Hauptbremszylinder								
1.4 16V	66	09/98→05/05			- ESP; für Fahrzeuge mit Scheiben-		24.2123-1734.3 010640	TRW Ø 23,8
1.6	55 -	09/98→05/05			bremse an der Hinterachse			
	62							
1.6 16V	74	09/98→05/05			22000001→; - ESP; für Fahrzeuge mit		24.2123-1734.3 010640	TRW Ø 23,8
1.6 Dualfuel	55 -	02/98→05/05			Trommelbremse an der Hinterachse			
	74							
	55				+ ESP		24.2123-1739.3 010661	Ø 23,8
1.7 DTI 16V	55	02/00→05/05						
1.7 CDTI 16V	59	04/03→05/05			- ESP		24.2123-1734.3 010640	TRW Ø 23,8
1.7 TD	50	09/98→08/00			- ESP; für Fahrzeuge mit Scheiben-		24.2123-1734.3 010640	TRW Ø 23,8
					bremse an der Hinterachse			
					+ ESP		24.2123-1739.3 010661	Ø 23,8
1.8 16V	85 -	02/98→07/04			04/98→; - ESP		24.2123-1734.3 010640	TRW Ø 23,8
1.8 16V Dualfuel	92							
2.0 DI	60	02/98→07/04			04/98→; + ESP		24.2123-1739.3 010661	Ø 23,8
1.8 16V Dualfuel	92	07/02→12/03			- ESP		24.2123-1734.3 010640	TRW Ø 23,8
2.0 16V	100	09/98→05/05			+ ESP		24.2123-1739.3 010661	Ø 23,8
2.0 DTI 16V	74	02/98→07/04			08/99→; - ESP		24.2123-1734.3 010640	TRW Ø 23,8
					08/99→; + ESP		24.2123-1739.3 010661	Ø 23,8
VAUXHALL - ASTRA Mk V (H) (A04) 01/04→03/11								
 Bremskraftverstärker								
1.9 CDTI	88 -	01/04→05/09			09/04→; für Linkslenker		03.7863-7803.4 300237	ATE Ø 10" pneumatisch
1.9 CDTI 16V	110							
	88	01/04→05/09						
 Hauptbremszylinder								
1.3 CDTI	66	01/04→05/09			08/05→; → 68999999; für Linkslenker; +		24.2125-1736.3 010904	TRW Ø 25,4
					ESP			
					08/05→; → 68999999; für Rechtslenker		24.2125-1736.3 010904	TRW Ø 25,4
					08/05→; → 68999999; für Linkslenker; -		24.2125-1737.3 010906	TRW Ø 25,4
					ESP			
					72000001→; für Rechtslenker		24.4125-1703.3 010907	TRW Ø 25,4
					72000001→; für Linkslenker; + ESP		24.4125-1703.3 010907	TRW Ø 25,4
					72000001→; für Linkslenker; - ESP		24.4125-1704.3 010908	TRW Ø 25,4
1.4	66	01/04→05/09			für Rechtslenker; → 68999999		24.2125-1736.3 010904	TRW Ø 25,4
1.6	77	01/04→05/09			für Linkslenker; → 68999999; + ESP		24.2125-1736.3 010904	TRW Ø 25,4
1.7 CDTI	59 -	01/04→05/09			für Linkslenker; → 68999999; - ESP		24.2125-1737.3 010906	TRW Ø 25,4
	74				72000001→; für Rechtslenker		24.4125-1703.3 010907	TRW Ø 25,4
1.8	92	01/04→05/09			72000001→; für Linkslenker; + ESP		24.4125-1703.3 010907	TRW Ø 25,4
2.0 Turbo	125	01/04→05/09			72000001→; für Linkslenker; - ESP		24.4125-1704.3 010908	TRW Ø 25,4
					01/07→; → 68999999; für Linkslenker; +		24.2125-1736.3 010904	TRW Ø 25,4
1.6	85	01/04→05/09			ESP			
1.6 Turbo	132	09/06→09/09			01/07→; → 68999999; für Rechtslenker		24.2125-1736.3 010904	TRW Ø 25,4
					01/07→; → 68999999; für Linkslenker; -		24.2125-1737.3 010906	TRW Ø 25,4
					ESP			
					72000001→; für Rechtslenker		24.4125-1703.3 010907	TRW Ø 25,4
					72000001→; für Linkslenker; + ESP		24.4125-1703.3 010907	TRW Ø 25,4
					72000001→; für Linkslenker; - ESP		24.4125-1704.3 010908	TRW Ø 25,4
1.7 CDTI	81	01/04→03/11			04/07→; → 68999999; für Linkslenker; +		24.2125-1736.3 010904	TRW Ø 25,4
					ESP			
					04/07→; → 68999999; für Rechtslenker		24.2125-1736.3 010904	TRW Ø 25,4
					04/07→; → 68999999; für Linkslenker; -		24.2125-1737.3 010906	TRW Ø 25,4
					ESP			
					72000001→; für Rechtslenker		24.4125-1703.3 010907	TRW Ø 25,4
					72000001→; für Linkslenker; + ESP		24.4125-1703.3 010907	TRW Ø 25,4
→								



VAUXHALL - ASTRA Mk V (H) (A04) 01/04→03/11

 **Hauptbremszylinder**

1.7 CDTi	81	01/04→03/11		72000001→; für Linkslenker; - ESP	24.4125-1704.3	010908	TRW Ø 25,4
1.8	103	01/04→05/09		01/06→; → 68999999; für Linkslenker; + ESP	24.2125-1736.3	010904	TRW Ø 25,4
				01/06→; → 68999999; für Rechtslenker	24.2125-1736.3	010904	TRW Ø 25,4
				01/06→; → 68999999; für Linkslenker; - ESP	24.2125-1737.3	010906	TRW Ø 25,4
				72000001→; für Rechtslenker	24.4125-1703.3	010907	TRW Ø 25,4
				72000001→; für Linkslenker; + ESP	24.4125-1703.3	010907	TRW Ø 25,4
				72000001→; für Linkslenker; - ESP	24.4125-1704.3	010908	TRW Ø 25,4
1.9 CDTI	88 - 110	01/04→05/09		09/04→	03.4155-0156.3	010862	ATE Ø 25,4
1.9 CDTI 16V	88	01/04→05/09					
2.0 Turbo	147	01/04→05/09		09/04→; für Linkslenker; → 68999999; + ESP	24.2125-1736.3	010904	TRW Ø 25,4
				09/04→; für Rechtslenker; → 68999999	24.2125-1736.3	010904	TRW Ø 25,4
				09/04→; für Linkslenker; → 68999999; - ESP	24.2125-1737.3	010906	TRW Ø 25,4
				72000001→; für Rechtslenker	24.4125-1703.3	010907	TRW Ø 25,4
				72000001→; für Linkslenker; + ESP	24.4125-1703.3	010907	TRW Ø 25,4
				72000001→; für Linkslenker; - ESP	24.4125-1704.3	010908	TRW Ø 25,4
2.0 Turbo	177	01/04→05/09		03/05→; → 68999999; für Linkslenker; + ESP	24.2125-1736.3	010904	TRW Ø 25,4
				03/05→; → 68999999; für Rechtslenker	24.2125-1736.3	010904	TRW Ø 25,4
				03/05→; → 68999999; für Linkslenker; - ESP	24.2125-1737.3	010906	TRW Ø 25,4
				72000001→; für Rechtslenker	24.4125-1703.3	010907	TRW Ø 25,4
				72000001→; für Linkslenker; + ESP	24.4125-1703.3	010907	TRW Ø 25,4
				72000001→; für Linkslenker; - ESP	24.4125-1704.3	010908	TRW Ø 25,4











VAUXHALL - ASTRA Mk V (H) Kombi (A04) 08/04→10/12

 **Bremskraftverstärker**











1.9 CDTi	88	08/04→03/09		für Linkslenker	03.7863-7803.4	300237	ATE Ø 10" pneumatisch
1.9 CDTi 16V	88	08/04→03/09					
1.9 CDTi	110	08/04→03/09		09/04→; für Linkslenker	03.7863-7803.4	300237	ATE Ø 10" pneumatisch













 **Hauptbremszylinder**

1.3 CDTi	66	08/04→03/09		72000001→; für Linkslenker; + ESP	24.2125-1703.3	010483	Ø 25,4
				72000001→; für Linkslenker; - ESP	24.2125-1704.3	010446	TRW Ø 25,4
				08/05→; → 62999999; für Rechtslenker	24.2125-1736.3	010904	TRW Ø 25,4
				08/05→; → 68999999; für Linkslenker; + ESP	24.2125-1736.3	010904	TRW Ø 25,4
				08/05→; → 68999999; für Linkslenker; - ESP	24.2125-1737.3	010906	TRW Ø 25,4
				72000001→; für Rechtslenker	24.4125-1703.3	010907	TRW Ø 25,4
1.4	66	08/04→03/09		72000001→; für Linkslenker; + ESP	24.2125-1703.3	010483	Ø 25,4
1.6	77	08/04→03/09		72000001→; für Linkslenker; - ESP	24.2125-1704.3	010446	TRW Ø 25,4
1.7 CDTi	74	08/04→03/09					
1.7 CDTi	59	08/04→05/09		→ 62999999; für Rechtslenker	24.2125-1736.3	010904	TRW Ø 25,4
1.8	92 - 103	10/04→10/10		→ 68999999; für Linkslenker; + ESP	24.2125-1736.3	010904	TRW Ø 25,4
				→ 68999999; für Linkslenker; - ESP	24.2125-1737.3	010906	TRW Ø 25,4
2.0 Turbo	125	08/04→10/10		72000001→; für Rechtslenker	24.4125-1703.3	010907	TRW Ø 25,4
1.6	85 - 132	08/04→03/11		72000001→; für Linkslenker; + ESP	24.2125-1703.3	010483	Ø 25,4
				72000001→; für Linkslenker; - ESP	24.2125-1704.3	010446	TRW Ø 25,4
				01/07→; → 62999999; für Rechtslenker	24.2125-1736.3	010904	TRW Ø 25,4
				01/07→; → 68999999; für Linkslenker; + ESP	24.2125-1736.3	010904	TRW Ø 25,4
				01/07→; → 68999999; für Linkslenker; - ESP	24.2125-1737.3	010906	TRW Ø 25,4
				72000001→; für Rechtslenker	24.4125-1703.3	010907	TRW Ø 25,4
1.7 CDTi	81	08/04→10/12		72000001→; → 11/10; für Linkslenker; + ESP	24.2125-1703.3	010483	Ø 25,4
				72000001→; → 11/10; für Linkslenker; - ESP	24.2125-1704.3	010446	TRW Ø 25,4
				04/07→; → 62999999; für Rechtslenker	24.2125-1736.3	010904	TRW Ø 25,4
				04/07→; → 68999999; für Linkslenker; + ESP	24.2125-1736.3	010904	TRW Ø 25,4
				04/07→; → 68999999; für Linkslenker; - ESP	24.2125-1737.3	010906	TRW Ø 25,4















	kw				! #		
VAUXHALL - ASTRA Mk V (H) Kombi (A04) 08/04→10/12							
 Hauptbremszylinder							
1.7 CDTi	81	08/04→10/12		72000001→; → 11/10; für Rechtslenker		24.4125-1703.3 010907	TRW Ø 25,4
1.9 CDTi	88	08/04→03/09				03.4155-0156.3 010862	ATE Ø 25,4
1.9 CDTi 16V	88	08/04→03/09					
1.9 CDTi	110	08/04→03/09		09/04→		03.4155-0156.3 010862	ATE Ø 25,4
2.0 Turbo	147	08/04→10/10		72000001→; für Linkslenker; + ESP		24.2125-1703.3 010483	Ø 25,4
				72000001→; für Linkslenker; - ESP		24.2125-1704.3 010446	TRW Ø 25,4
				09/04→; → 62999999; für Rechtslenker		24.2125-1736.3 010904	TRW Ø 25,4
				09/04→; → 68999999; für Linkslenker; + ESP		24.2125-1736.3 010904	TRW Ø 25,4
				09/04→; → 68999999; für Linkslenker; - ESP		24.2125-1737.3 010906	TRW Ø 25,4
				72000001→; für Rechtslenker		24.4125-1703.3 010907	TRW Ø 25,4
VAUXHALL - ASTRA Mk V (H) Sport Hatch (A04) 02/05→11/10							
 Bremskraftverstärker							
1.9 CDTi	74	08/05→11/10		09/05→; für Linkslenker		03.7863-7803.4 300237	ATE Ø 10" pneumatisch
1.9 CDTi	88 - 110	02/05→11/10		für Linkslenker		03.7863-7803.4 300237	ATE Ø 10" pneumatisch
 Hauptbremszylinder							
1.3 CDTi	66	04/05→11/10		08/05→; → 68999999; für Linkslenker; + ESP		24.2125-1736.3 010904	TRW Ø 25,4
				08/05→; → 68999999; für Rechtslenker		24.2125-1736.3 010904	TRW Ø 25,4
				08/05→; → 68999999; für Linkslenker; - ESP		24.2125-1737.3 010906	TRW Ø 25,4
				72000001→; für Rechtslenker		24.4125-1703.3 010907	TRW Ø 25,4
				72000001→; für Linkslenker; + ESP		24.4125-1703.3 010907	TRW Ø 25,4
				72000001→; für Linkslenker; - ESP		24.4125-1704.3 010908	TRW Ø 25,4
1.4 i 16V 1.6 1.7 CDTi 1.8 1.8 i 16V 2.0 Turbo 2.0 VXR	66 77 74 92 103 125 176	03/05→11/10 02/05→11/10 02/05→11/10 02/05→11/10 03/07→11/10 02/05→11/10 02/09→11/10		für Rechtslenker; → 68999999		24.2125-1736.3 010904	TRW Ø 25,4
				für Linkslenker; → 68999999; + ESP		24.2125-1736.3 010904	TRW Ø 25,4
				für Linkslenker; → 68999999; - ESP		24.2125-1737.3 010906	TRW Ø 25,4
				72000001→; für Rechtslenker		24.4125-1703.3 010907	TRW Ø 25,4
				72000001→; für Linkslenker; + ESP		24.4125-1703.3 010907	TRW Ø 25,4
				72000001→; für Linkslenker; - ESP		24.4125-1704.3 010908	TRW Ø 25,4
1.6 1.6 i 16V	132 85	10/06→11/10 12/06→11/10		01/07→; → 68999999; für Linkslenker; + ESP		24.2125-1736.3 010904	TRW Ø 25,4
				01/07→; → 68999999; für Rechtslenker		24.2125-1736.3 010904	TRW Ø 25,4
				01/07→; → 68999999; für Linkslenker; - ESP		24.2125-1737.3 010906	TRW Ø 25,4
				72000001→; für Rechtslenker		24.4125-1703.3 010907	TRW Ø 25,4
				72000001→; für Linkslenker; + ESP		24.4125-1703.3 010907	TRW Ø 25,4
				72000001→; für Linkslenker; - ESP		24.4125-1704.3 010908	TRW Ø 25,4
1.7 CDTi	81	02/07→11/09		04/07→; → 68999999; für Linkslenker; + ESP		24.2125-1736.3 010904	TRW Ø 25,4
				04/07→; → 68999999; für Rechtslenker		24.2125-1736.3 010904	TRW Ø 25,4
				04/07→; → 68999999; für Linkslenker; - ESP		24.2125-1737.3 010906	TRW Ø 25,4
				72000001→; für Rechtslenker		24.4125-1703.3 010907	TRW Ø 25,4
				72000001→; für Linkslenker; + ESP		24.4125-1703.3 010907	TRW Ø 25,4
				72000001→; für Linkslenker; - ESP		24.4125-1704.3 010908	TRW Ø 25,4
1.9 CDTi	74	08/05→11/10		09/05→		03.4155-0156.3 010862	ATE Ø 25,4
1.9 CDTi	88 - 110	02/05→11/10				03.4155-0156.3 010862	ATE Ø 25,4
VAUXHALL - ASTRA Mk V (H) TwinTop (A04) 09/05→08/11							
 Bremskraftverstärker							
1.9 CDTi	110	01/06→11/10		03/06→; für Linkslenker		03.7863-7803.4 300237	ATE Ø 10" pneumatisch
 Hauptbremszylinder							
1.6 2.0 2.0 Turbo	77 125 147	09/05→11/10 02/06→11/10 01/06→11/10		03/06→; → 68999999; für Linkslenker; + ESP		24.2125-1736.3 010904	TRW Ø 25,4
				03/06→; → 68999999; für Rechtslenker		24.2125-1736.3 010904	TRW Ø 25,4
				03/06→; → 68999999; für Linkslenker; - ESP		24.2125-1737.3 010906	TRW Ø 25,4
				03/06→; für Rechtslenker		24.4125-1703.3 010907	TRW Ø 25,4
				72000001→; für Linkslenker; + ESP		24.4125-1703.3 010907	TRW Ø 25,4
→							













	kW					! #		
VAUXHALL - ASTRA Mk V (H) TwinTop (A04) 09/05→08/11								
 Hauptbremszylinder								
1.6 2.0 2.0 Turbo	77 125 147	09/05→11/10 02/06→11/10 01/06→11/10			72000001→; für Linkslenker; - ESP		24.4125-1704.3 010908	TRW Ø 25,4
1.6 i 16V	85	10/06→08/11			12/06→; → 68999999; für Linkslenker; + ESP		24.2125-1736.3 010904	TRW Ø 25,4
					12/06→; → 68999999; für Rechtslenker		24.2125-1736.3 010904	TRW Ø 25,4
					12/06→; → 68999999; für Linkslenker; - ESP		24.2125-1737.3 010906	TRW Ø 25,4
					12/06→; für Rechtslenker		24.4125-1703.3 010907	TRW Ø 25,4
					72000001→; für Linkslenker; + ESP		24.4125-1703.3 010907	TRW Ø 25,4
					72000001→; für Linkslenker; - ESP		24.4125-1704.3 010908	TRW Ø 25,4
1.8	103	05/08→11/10			→ 68999999; für Rechtslenker		24.2125-1736.3 010904	TRW Ø 25,4
					→ 68999999; für Linkslenker; + ESP		24.2125-1736.3 010904	TRW Ø 25,4
					→ 68999999; für Linkslenker; - ESP		24.2125-1737.3 010906	TRW Ø 25,4
					für Rechtslenker		24.4125-1703.3 010907	TRW Ø 25,4
					72000001→; für Linkslenker; + ESP		24.4125-1703.3 010907	TRW Ø 25,4
					72000001→; für Linkslenker; - ESP		24.4125-1704.3 010908	TRW Ø 25,4
1.9 CDTi	110	01/06→11/10			03/06→; für Rechtslenker		03.4155-0156.3 010862	ATE Ø 25,4
					03/06→; für Linkslenker; + ESP		03.4155-0156.3 010862	ATE Ø 25,4
VAUXHALL - ASTRA Mk VI (J) (P10) 12/09→10/15								
 Bremskraftverstärker								
1.3 CDTi 1.4 1.4 Turbo 1.6 1.6 Turbo 1.7 CDTi 1.7 CDTi 2.0 BiTurbo CDTi 2.0 CDTi	70 64 - 74 88 - 103 85 132 81 - 96 74 143 118 - 121	12/09→10/15 12/09→10/15 12/09→10/15 12/09→10/15 12/09→10/15 12/09→10/15 10/10→10/15 12/12→10/15 12/09→10/15			für Linkslenker		03.7858-0732.4 300272	ATE Ø 9 / 8" pneumatisch
1.6 CDTi	81	11/13→10/15			02/14→; für Linkslenker		03.7858-0732.4 300272	ATE Ø 9 / 8" pneumatisch
1.6 CDTi	100	11/13→10/15			01/14→; für Linkslenker		03.7858-0732.4 300272	ATE Ø 9 / 8" pneumatisch
 Hauptbremszylinder								
1.3 CDTi 1.4 1.4 Turbo 1.6 1.6 Turbo 1.7 CDTi 1.7 CDTi 2.0 BiTurbo CDTi 2.0 CDTi	70 64 - 74 103 85 132 81 - 96 74 143 118 - 121	12/09→10/15 12/09→10/15 12/09→10/15 12/09→10/15 12/09→10/15 12/09→10/15 10/10→10/15 12/12→10/15 12/09→10/15			für Linkslenker		03.2125-0421.3 010934	ATE Ø 25,4
1.4 Turbo	88	08/10→10/15			für Rechtslenker		24.4155-0201.3 011125	ATE Ø 25,4 ohne Bremsflüssigkeitsbehälter
1.4 Turbo	88	08/10→10/15			für Linkslenker		03.2125-0421.3 010934	ATE Ø 25,4
					11/10→; für Rechtslenker		24.4155-0201.3 011125	ATE Ø 25,4 ohne Bremsflüssigkeitsbehälter
1.6 CDTi	81	11/13→10/15			für Linkslenker		03.2125-0421.3 010934	ATE Ø 25,4
					02/14→; für Rechtslenker		24.4155-0201.3 011125	ATE Ø 25,4 ohne Bremsflüssigkeitsbehälter
1.6 CDTi	100	11/13→10/15			01/14→; für Linkslenker		03.2125-0421.3 010934	ATE Ø 25,4
					01/14→; für Rechtslenker		24.4155-0201.3 011125	ATE Ø 25,4 ohne Bremsflüssigkeitsbehälter
VAUXHALL - ASTRA Mk VI (J) GTC (P10) 10/11→10/18								
 Bremskraftverstärker								
1.4 1.6 1.6 CDTi 1.6 SIDI 1.7 CDTi →	74 - 103 132 81 - 100 125 - 147 81 - 96	10/11→10/18 10/11→10/18 07/14→10/18 09/13→10/18 10/11→10/18			für Linkslenker		03.7858-0732.4 300272	ATE Ø 9 / 8" pneumatisch













	kw					! #		
VAUXHALL - ASTRA Mk VI (J) GTC (P10) 10/11→10/18								
 Bremskraftverstärker								
2.0 BiTurbo CDTI 2.0 CDTi	143 121	12/12→10/18 10/11→10/18		für Linkslenker		03.7858-0732.4	300272	ATE Ø 9 / 8" pneumatisch
 Hauptbremszylinder								
1.4 1.6 1.6 CDTi 1.6 SIDI 1.7 CDTi 2.0 BiTurbo CDTI 2.0 CDTi	74 - 103 132 81 - 100 125 - 147 81 - 96 143 121	10/11→10/18 10/11→10/18 07/14→10/18 09/13→10/18 10/11→10/18 12/12→10/18 10/11→10/18		für Linkslenker für Rechtslenker		03.2125-0421.3 24.4155-0201.3	010934 011125	ATE Ø 25,4 ATE Ø 25,4 ohne Bremsflüssigkeitsbehälter
VAUXHALL - ASTRA Mk VI (J) Kombi (P10) 10/10→10/15								
 Bremskraftverstärker								
1.3 CDTi 1.4 1.4 Turbo 1.6 1.6 Turbo 1.7 CDTi 2.0 CDTi 1.6 CDTi 1.6 CDTi 1.7 CDTi 2.0 BiTurbo CDTI 2.0 CDTi	70 64 - 74 103 85 132 81 - 92 118 81 100 96 143 121	10/10→10/15 10/10→10/15 10/10→10/15 10/10→10/15 10/10→10/15 10/10→10/15 10/10→06/11 01/14→10/15 01/14→10/15 06/11→10/15 12/12→10/15 08/11→10/15		11/10→; für Linkslenker 02/14→; für Linkslenker für Linkslenker		03.7858-0732.4 03.7858-0732.4 03.7858-0732.4	300272 300272 300272	ATE Ø 9 / 8" pneumatisch ATE Ø 9 / 8" pneumatisch ATE Ø 9 / 8" pneumatisch
 Hauptbremszylinder								
1.3 CDTi 1.4 1.4 Turbo 1.6 1.6 Turbo 1.7 CDTi 2.0 CDTi 1.6 CDTi 1.6 CDTi 1.7 CDTi 2.0 BiTurbo CDTI 2.0 CDTi	70 64 - 74 103 85 132 81 - 92 118 81 100 96 143 121	10/10→10/15 10/10→10/15 10/10→10/15 10/10→10/15 10/10→10/15 10/10→10/15 10/10→06/11 01/14→10/15 01/14→10/15 06/11→10/15 12/12→10/15 08/11→10/15		11/10→; für Linkslenker 11/10→; für Rechtslenker 02/14→; für Linkslenker 02/14→; für Rechtslenker für Linkslenker für Rechtslenker		03.2125-0421.3 24.4155-0201.3 03.2125-0421.3 24.4155-0201.3 03.2125-0421.3 24.4155-0201.3	010934 011125 010934 011125 010934 011125	ATE Ø 25,4 ATE Ø 25,4 ohne Bremsflüssigkeitsbehälter ATE Ø 25,4 ATE Ø 25,4 ohne Bremsflüssigkeitsbehälter ATE Ø 25,4 ATE Ø 25,4 ohne Bremsflüssigkeitsbehälter
VAUXHALL - ASTRAVAN Mk IV (G) Kasten/Kombi (T98) 01/93→08/06								
 Hauptbremszylinder								
1.4 16V 1.6 Dualfuel 1.6 Dualfuel 16V 1.6 i 1.7 DTI 16V 1.7 CDTI 1.7 TD 2.0 DI 2.0 DTI	66 55 - 74 77 55 - 62 55 59 50 60 74	09/00→05/05 02/98→08/05 10/04→12/05 08/98→08/06 04/01→08/06 07/03→08/06 08/98→08/06 08/98→08/06 04/04→08/06		- ESP; für Fahrzeuge mit Scheibenbremse an der Hinterachse 22000001→; - ESP; für Fahrzeuge mit Trommelbremse an der Hinterachse + ESP - ESP - ESP; für Fahrzeuge mit Scheibenbremse an der Hinterachse + ESP - ESP + ESP		24.2123-1734.3 24.2123-1734.3 24.2123-1739.3 24.2123-1734.3 24.2123-1734.3 24.2123-1739.3 24.2123-1734.3 24.2123-1739.3	010640 010640 010661 010640 010640 010661 010640 010661	TRW Ø 23,8 TRW Ø 23,8 Ø 23,8 TRW Ø 23,8 TRW Ø 23,8 Ø 23,8 TRW Ø 23,8 Ø 23,8
 Bremskraftregler								
1.4 16V 1.6 Dualfuel 1.6 Dualfuel 16V 1.7 CDTI 1.7 TD	66 55 - 74 59 50	09/00→05/05 02/98→08/05 10/04→12/05 07/03→08/06 08/98→08/06		- ABS		03.6583-0073.3	320234	ATE lastabhängig 8/3 4x

















	kw					! #		
VAUXHALL - ASTRAVAN Mk V (H) Kasten/Kombi (A04) 03/05→								
 Bremskraftverstärker								
1.9 CDTi	88 - 110	03/05→11/11		→ 11/10; für Linkslenker		03.7863-7803.4	300237	ATE Ø 10" pneumatisch
 Hauptbremszylinder								
1.3 CDTi	66	08/05→		72000001→; → 11/10; für Linkslenker; + ESP		24.2125-1703.3	010483	Ø 25,4
1.4 i	66	03/05→						
1.6	76	03/05→		72000001→; → 11/10; für Linkslenker; - ESP		24.2125-1704.3	010446	TRW Ø 25,4
1.7 CDTi	74	03/05→11/11						
				→ 62999999; für Rechtslenker		24.2125-1736.3	010904	TRW Ø 25,4
				→ 68999999; für Linkslenker; + ESP		24.2125-1736.3	010904	TRW Ø 25,4
				→ 68999999; für Linkslenker; - ESP		24.2125-1737.3	010906	TRW Ø 25,4
				72000001→; → 11/10; für Rechtslenker		24.4125-1703.3	010907	TRW Ø 25,4
1.7 CDTi	59	03/05→07/06		72000001→; für Linkslenker; + ESP		24.2125-1703.3	010483	Ø 25,4
				72000001→; für Linkslenker; - ESP		24.2125-1704.3	010446	TRW Ø 25,4
				→ 62999999; für Rechtslenker		24.2125-1736.3	010904	TRW Ø 25,4
				→ 68999999; für Linkslenker; + ESP		24.2125-1736.3	010904	TRW Ø 25,4
				→ 68999999; für Linkslenker; - ESP		24.2125-1737.3	010906	TRW Ø 25,4
				72000001→; für Rechtslenker		24.4125-1703.3	010907	TRW Ø 25,4
1.7 CDTi	81 - 92	06/11→		→ 62999999; für Rechtslenker		24.2125-1736.3	010904	TRW Ø 25,4
				→ 68999999; für Linkslenker; + ESP		24.2125-1736.3	010904	TRW Ø 25,4
				→ 68999999; für Linkslenker; - ESP		24.2125-1737.3	010906	TRW Ø 25,4
1.9 CDTi	88 - 110	03/05→11/11		→ 11/10		03.4155-0156.3	010862	ATE Ø 25,4
VAUXHALL - CASCADA Cabriolet (W13) 02/13→								
 Bremskraftverstärker								
1.4	103	02/13→		für Linkslenker		03.7858-0732.4	300272	ATE Ø 9 / 8" pneumatisch
1.6	125 - 147	02/13→						
2.0 CDTI	121 - 143	02/13→						
 Hauptbremszylinder								
1.4	103	02/13→		für Linkslenker		03.2125-0421.3	010934	ATE Ø 25,4
1.6	125 - 147	02/13→						
2.0 CDTI	121 - 143	02/13→		für Rechtslenker		24.4155-0201.3	011125	ATE Ø 25,4 ohne Bremsflüssigkeitsbehälter
VAUXHALL - COMBO Mk I (B) (S93) 07/94→10/01								
 Hauptbremszylinder								
1.4	44	07/94→10/01		→ 09/00; für Linkslenker; - ABS		24.2120-0702.3	010361	nicht für Delco Ø 20,6
1.4 16V	66	08/99→10/01		→ 09/00; für Linkslenker; + ABS		24.2120-1714.3	010455	Ø 20,6
1.7 D	44	07/94→10/01						
VAUXHALL - COMBO Mk II (C) Kasten/Großraumlimousine (F25) 09/01→02/12								
 Hauptbremszylinder								
1.3 CDTI 16V	51 - 55	09/04→02/12		→ 33999999		24.2122-1740.3	010711	DEL Ø 22,2
1.4 i 16V	66	01/04→11/11		43000001→; → 10/11; - ESP; Scheibenbremse		24.2123-1767.3	010844	BOS Ø 23,8
1.6	64	10/01→11/11						
1.7 DTI 16V	55	10/01→11/11						
1.4 16V	66	10/01→05/07		→ 33999999		24.2122-1740.3	010711	DEL Ø 22,2
				43000001→; - ESP; Scheibenbremse		24.2123-1767.3	010844	BOS Ø 23,8
1.6	62	09/01→10/04		10/01→; → 33999999		24.2122-1740.3	010711	DEL Ø 22,2
				43000001→; - ESP; Scheibenbremse		24.2123-1767.3	010844	BOS Ø 23,8
1.6 CNG 16V	69 - 71	04/05→02/12		→ 10/11; - ESP; Scheibenbremse		24.2123-1767.3	010844	BOS Ø 23,8
1.7 CDTI 16V	74	12/04→11/11						
1.7 DI 16V	48	09/01→11/11		10/01→; → 33999999		24.2122-1740.3	010711	DEL Ø 22,2
				43000001→; → 10/11; - ESP; Scheibenbremse		24.2123-1767.3	010844	BOS Ø 23,8
VAUXHALL - COMBO TOUR Mk II (C) (F25) 09/01→02/12								
 Hauptbremszylinder								
1.3 CDTI 16V	51	09/04→09/06		→ 33999999		24.2122-1740.3	010711	DEL Ø 22,2
1.4	66	10/04→09/10		43000001→; - ESP; Scheibenbremse		24.2123-1767.3	010844	BOS Ø 23,8
1.6	64	10/01→06/04						
1.3 CDTI 16V	55	07/06→02/12		→ 33999999		24.2122-1740.3	010711	DEL Ø 22,2
→								

	kw					! #		
VAUXHALL - COMBO TOUR Mk II (C) (F25) 09/01→02/12								
 Hauptbremszylinder								
1.7 DTI 16V	55	10/01→02/12		43000001→; → 10/11; - ESP; Scheibenbremse			24.2123-1767.3 010844	BOS Ø 23,8
1.6 CNG 1.7 CDTI 16V	69 74	06/06→09/10 12/04→09/10		- ESP; Scheibenbremse			24.2123-1767.3 010844	BOS Ø 23,8
1.6 CNG	71	04/05→02/12		→ 10/11; - ESP; Scheibenbremse			24.2123-1767.3 010844	BOS Ø 23,8
1.7 DI 16V	48	09/01→06/04		10/01→; → 33999999			24.2122-1740.3 010711	DEL Ø 22,2
				43000001→; - ESP; Scheibenbremse			24.2123-1767.3 010844	BOS Ø 23,8
VAUXHALL - CORSA Mk I (B) (S93) 12/92→09/00								
 Hauptbremszylinder								
1.0 i 12V	40	11/96→09/00		für Linkslenker; - ABS			24.2120-0702.3 010361	nicht für Delco Ø 20,6
1.4 i	44	03/93→09/00		für Linkslenker; + ABS			24.2120-1714.3 010455	Ø 20,6
1.4 i 16V	66	09/94→09/00						
1.4 i S	60	03/93→09/00						
1.6 i 16V	78	09/94→09/00						
1.7 D	44	02/96→09/00						
1.2 i	33	03/93→09/00		für Linkslenker; - ABS			24.2120-0702.3 010361	nicht für Delco Ø 20,6
				04/98→; für Linkslenker; - ABS			24.2120-0702.3 010361	nicht für Delco Ø 20,6
				für Linkslenker; + ABS			24.2120-1714.3 010455	Ø 20,6
				04/98→; für Linkslenker; + ABS			24.2120-1714.3 010455	Ø 20,6
1.2 i 16V	48	03/98→09/00		04/98→; für Linkslenker; - ABS			24.2120-0702.3 010361	nicht für Delco Ø 20,6
				04/98→; für Linkslenker; + ABS			24.2120-1714.3 010455	Ø 20,6
1.6 GSI 16V	80	03/93→09/00		09/93→; für Linkslenker; - ABS			24.2120-0702.3 010361	nicht für Delco Ø 20,6
				09/93→; für Linkslenker; + ABS			24.2120-1714.3 010455	Ø 20,6
VAUXHALL - CORSA Mk II (C) (X01) 08/00→04/07								
 Hauptbremszylinder								
1.0 12V	43 - 44	09/00→10/06		→ 36999999			24.2122-1740.3 010711	DEL Ø 22,2
1.2 16V	55	09/00→10/06						
1.2 16V Dualfuel	55	08/01→10/06						
1.2 Twinport	59	07/04→10/06						
1.3 CDTI 16V	51	10/03→04/07						
1.4 16V	66	09/00→10/06		43000001→; → 09/06; - ESP			24.2123-1767.3 010844	BOS Ø 23,8
1.4 Twinport	66	06/03→10/06						
1.7 CDTI 16V	74	08/00→09/06		06/03→; → 36999999			24.2122-1740.3 010711	DEL Ø 22,2
1.7 DI 16V	48	08/00→09/06		09/00→; → 36999999			24.2122-1740.3 010711	DEL Ø 22,2
1.7 DTI 16V	55	08/00→09/06						
1.8 16V	92	08/00→09/06		43000001→; - ESP			24.2123-1767.3 010844	BOS Ø 23,8
VAUXHALL - CORSA Mk III (D) (S07) 07/06→08/14								
 Hauptbremszylinder								
1.0	44	08/06→08/14		für Linkslenker; + ESP			24.4122-1705.3 010852	BOS Ø 22,2 ohne Bremsflüssigkeitsbehälter
1.2	59	08/06→08/14		für Linkslenker; - ESP			24.4122-1709.3 010871	BOS Ø 22,2 ohne Bremsflüssigkeitsbehälter
				10/06→; für Rechtslenker; + ESP			24.4122-1737.3 011147	BOS Ø 22,2 ohne Bremsflüssigkeitsbehälter
				10/06→; für Rechtslenker; - ESP			24.4122-1738.3 011148	BOS Ø 22,2 ohne Bremsflüssigkeitsbehälter
1.0 i 12V	48	01/10→08/14		für Linkslenker; + ESP			24.4122-1705.3 010852	BOS Ø 22,2 ohne Bremsflüssigkeitsbehälter
1.2	51	06/10→08/14						
1.2 LPG	59 - 63	09/09→08/14		für Linkslenker; - ESP			24.4122-1709.3 010871	BOS Ø 22,2 ohne Bremsflüssigkeitsbehälter
1.3 CDTI	70	07/10→08/14		für Rechtslenker; + ESP			24.4122-1737.3 011147	BOS Ø 22,2 ohne Bremsflüssigkeitsbehälter
				für Rechtslenker; - ESP			24.4122-1738.3 011148	BOS Ø 22,2 ohne Bremsflüssigkeitsbehälter
1.2 i 16V	63	12/09→08/14		06/10→; für Linkslenker; + ESP			24.4122-1705.3 010852	BOS Ø 22,2 ohne Bremsflüssigkeitsbehälter
				06/10→; für Linkslenker; - ESP			24.4122-1709.3 010871	BOS Ø 22,2 ohne Bremsflüssigkeitsbehälter
				06/10→; für Rechtslenker; + ESP			24.4122-1737.3 011147	BOS Ø 22,2 ohne Bremsflüssigkeitsbehälter
				06/10→; für Rechtslenker; - ESP			24.4122-1738.3 011148	BOS Ø 22,2 ohne Bremsflüssigkeitsbehälter
1.3 CDTI	55 - 66	08/06→08/14		10/06→; für Linkslenker; + ESP			24.4122-1705.3 010852	BOS Ø 22,2 ohne Bremsflüssigkeitsbehälter
1.4	66	08/06→08/14						
1.4 LPG	66	07/06→08/14						
→								



	kW					! #		
VAUXHALL - CORSA Mk III (D) (S07) 07/06→08/14								
 Hauptbremszylinder								
1.3 CDTI	55 - 66	08/06→08/14		10/06→; für Linkslenker; - ESP		24.4122-1709.3	010871	BOS Ø 22,2 ohne Bremsflüssigkeitsbehälter
1.4	66	08/06→08/14		10/06→; für Rechtslenker; + ESP		24.4122-1737.3	011147	BOS Ø 22,2 ohne Bremsflüssigkeitsbehälter
1.4 LPG	66	07/06→08/14		10/06→; für Rechtslenker; - ESP		24.4122-1738.3	011148	BOS Ø 22,2 ohne Bremsflüssigkeitsbehälter
1.4	74	01/10→08/14		für Linkslenker; + ESP		24.4122-1705.3	010852	BOS Ø 22,2 ohne Bremsflüssigkeitsbehälter
				für Linkslenker; - ESP		24.4122-1709.3	010871	BOS Ø 22,2 ohne Bremsflüssigkeitsbehälter
				06/10→; für Rechtslenker; + ESP		24.4122-1737.3	011147	BOS Ø 22,2 ohne Bremsflüssigkeitsbehälter
				06/10→; für Rechtslenker; - ESP		24.4122-1738.3	011148	BOS Ø 22,2 ohne Bremsflüssigkeitsbehälter
1.4	88	08/12→08/14		für Linkslenker; - ESP		24.4123-1720.3	011022	BOS Ø 23,8 ohne Bremsflüssigkeitsbehälter
1.6 VXR	141 - 155	11/06→08/14						
1.7 CDTI	92	11/06→08/14						
1.6 SRi	110	05/07→08/14		06/07→; für Linkslenker; - ESP		24.4123-1720.3	011022	BOS Ø 23,8 ohne Bremsflüssigkeitsbehälter
1.7 CDTI	96	03/07→08/14		06/10→; für Linkslenker; - ESP		24.4123-1720.3	011022	BOS Ø 23,8 ohne Bremsflüssigkeitsbehälter
VAUXHALL - CORSA Mk IV (E) (X15) 08/14→								
 Hauptbremszylinder								
1.0	66 - 85	08/14→		für Linkslenker; Trommelbremse		24.4122-1731.3	011100	Ø 22,2 ohne Bremsflüssigkeitsbehälter
1.2	51	08/14→		11/14→; für Linkslenker; Scheibenbremse		24.4123-1722.3	011071	Ø 23,8 ohne Bremsflüssigkeitsbehälter
1.3 CDTi	55 - 70	08/14→						
1.4	55 - 74	08/14→						
1.6 VXR	151	04/15→		für Linkslenker		24.4123-1722.3	011071	Ø 23,8 ohne Bremsflüssigkeitsbehälter
VAUXHALL - CORSAVAN Mk I (B) Kasten/Schrägheck (S93) 01/94→09/00								
 Hauptbremszylinder								
1.4 i	44	01/94→09/00		für Linkslenker; - ABS		24.2120-0702.3	010361	nicht für Delco Ø 20,6
1.7 D	44	01/94→09/00		für Linkslenker; + ABS		24.2120-1714.3	010455	Ø 20,6
VAUXHALL - CORSAVAN Mk II (C) Kasten/Schrägheck (X01) 09/00→11/06								
 Hauptbremszylinder								
1.2 16V	55 - 59	09/00→11/06		→ 36999999		24.2122-1740.3	010711	DEL Ø 22,2
1.2 16V Dualfuel	55 - 59	08/01→06/06						
1.3 CDTI 16V	52	04/04→06/06						
1.7 DI 16V	48	09/00→06/06						
1.7 DTI 16V	55	09/00→06/06						
1.4	66	11/03→06/06		43000001→; - ESP		24.2123-1767.3	010844	BOS Ø 23,8
VAUXHALL - CORSAVAN Mk III (D) Kasten/Schrägheck (S07) 07/06→								
 Hauptbremszylinder								
1.2	51	01/10→		06/10→; für Linkslenker; + ESP		24.4122-1705.3	010852	BOS Ø 22,2 ohne Bremsflüssigkeitsbehälter
1.3 CDTI	70	07/06→		06/10→; für Linkslenker; - ESP		24.4122-1709.3	010871	BOS Ø 22,2 ohne Bremsflüssigkeitsbehälter
				06/10→; für Rechtslenker; + ESP		24.4122-1737.3	011147	BOS Ø 22,2 ohne Bremsflüssigkeitsbehälter
				06/10→; für Rechtslenker; - ESP		24.4122-1738.3	011148	BOS Ø 22,2 ohne Bremsflüssigkeitsbehälter
1.2	59	07/09→		für Linkslenker; + ESP		24.4122-1705.3	010852	BOS Ø 22,2 ohne Bremsflüssigkeitsbehälter
				für Linkslenker; - ESP		24.4122-1709.3	010871	BOS Ø 22,2 ohne Bremsflüssigkeitsbehälter
				für Rechtslenker; + ESP		24.4122-1737.3	011147	BOS Ø 22,2 ohne Bremsflüssigkeitsbehälter
				für Rechtslenker; - ESP		24.4122-1738.3	011148	BOS Ø 22,2 ohne Bremsflüssigkeitsbehälter
→								

	kw					! #		
VAUXHALL - CORSAVAN Mk III (D) Kasten/Schrägheck (S07) 07/06→								
 Hauptbremszylinder								
1.3 CDTI	55 - 66	07/06→		10/06→; für Linkslenker; + ESP		24.4122-1705.3	010852	BOS Ø 22,2 ohne Bremsflüssigkeitsbehälter
				10/06→; für Linkslenker; - ESP		24.4122-1709.3	010871	BOS Ø 22,2 ohne Bremsflüssigkeitsbehälter
				10/06→; für Rechtslenker; + ESP		24.4122-1737.3	011147	BOS Ø 22,2 ohne Bremsflüssigkeitsbehälter
				10/06→; für Rechtslenker; - ESP		24.4122-1738.3	011148	BOS Ø 22,2 ohne Bremsflüssigkeitsbehälter
VAUXHALL - CORSAVAN Mk IV (E) Kasten/Schrägheck (X15) 10/14→								
 Hauptbremszylinder								
1.2 1.3 CDTi	51 55 - 70	10/14→ 10/14→		für Linkslenker; Trommelbremse		24.4122-1731.3	011100	Ø 22,2 ohne Bremsflüssigkeitsbehälter
				11/14→; für Linkslenker; Scheibenbremse		24.4123-1722.3	011071	Ø 23,8 ohne Bremsflüssigkeitsbehälter
VAUXHALL - CROSSLAND X / CROSSLAND (P17) 03/17→								
 Hauptbremszylinder								
1.2 1.5 Turbo D)) 1.5 Turbo D 1.6 Turbo D	61 - 96 81 75 - 88 73 - 88	03/17→ 10/20→ 06/18→ 03/17→05/18				24.4123-1704.3	010828	TRW Ø 23,8
VAUXHALL - INSIGNIA Mk I (A) Country Tourer (G09) 07/08→05/17								
 Bremskraftverstärker								
1.6 Turbo 2.0 Biturbo CDTI 4x4 2.0 CDTI 2.0 CDTI 4x4	125 143 120 - 125 125	07/13→05/17 09/13→05/17 07/13→05/17 11/14→05/17		für Linkslenker		03.7858-0732.4	300272	ATE Ø 9 / 8" pneumatisch
 Hauptbremszylinder								
1.6 Turbo 2.0 Biturbo CDTI 4x4 2.0 CDTI 2.0 CDTI 4x4 2.0 CDTI	125 143 125 125 120	07/13→05/17 09/13→05/17 11/14→05/17 11/14→05/17 07/13→05/17		für Linkslenker für Rechtslenker für Linkslenker 09/13→; für Rechtslenker für Rechtslenker		03.2125-0421.3 24.4155-0201.3 03.2125-0421.3 24.4155-0201.3 24.4155-0201.3	010934 011125 010934 011125 011125	ATE Ø 25,4 ATE Ø 25,4 ohne Bremsflüssigkeitsbehälter ATE Ø 25,4 ATE Ø 25,4 ohne Bremsflüssigkeitsbehälter ATE Ø 25,4 ohne Bremsflüssigkeitsbehälter
VAUXHALL - INSIGNIA Mk I (A) Schrägheck (G09) 07/08→05/17								
 Bremskraftverstärker								
1.4 1.4 LPG 1.6 1.6 CDTI 1.6 Turbo 1.8 2.0 Biturbo CDTI 2.0 Biturbo CDTI 4x4 2.0 CDTI 2.0 CDTI 4x4 2.0 Turbo 2.0 Turbo 4x4 2.0 CDTI 2.0 CDTI 4x4	103 103 85 100 125 - 132 103 143 143 81 - 140 125 - 140 162 - 184 162 88 118	04/11→05/17 07/12→05/17 07/08→07/12 07/15→05/17 01/09→05/17 07/08→05/17 03/12→05/17 03/12→05/17 07/08→05/17 05/09→05/17 07/08→05/17 07/08→05/17 03/12→03/16 07/08→05/17		06/11→; für Linkslenker für Linkslenker für Linkslenker 03/13→; für Linkslenker 06/10→; für Linkslenker		03.7858-0732.4 03.7858-0732.4 03.7858-0732.4 03.7858-0732.4 03.7858-0732.4 03.7858-0732.4 03.7858-0732.4 03.7858-0732.4 03.7858-0732.4 03.7858-0732.4 03.7858-0732.4 03.7858-0732.4 03.7858-0732.4 03.7858-0732.4	300272 300272 300272 300272 300272 300272 300272 300272 300272 300272 300272 300272 300272 300272	ATE Ø 9 / 8" pneumatisch ATE Ø 9 / 8" pneumatisch ATE Ø 9 / 8" pneumatisch ATE Ø 9 / 8" pneumatisch ATE Ø 9 / 8" pneumatisch ATE Ø 9 / 8" pneumatisch ATE Ø 9 / 8" pneumatisch ATE Ø 9 / 8" pneumatisch ATE Ø 9 / 8" pneumatisch ATE Ø 9 / 8" pneumatisch ATE Ø 9 / 8" pneumatisch ATE Ø 9 / 8" pneumatisch ATE Ø 9 / 8" pneumatisch ATE Ø 9 / 8" pneumatisch
 Hauptbremszylinder								
1.4 1.4 LPG 1.6 →	103 103 85	04/11→05/17 07/12→05/17 07/08→07/12		06/11→; für Linkslenker 06/11→; für Rechtslenker für Linkslenker		03.2125-0421.3 24.4155-0201.3 03.2125-0421.3	010934 011125 010934	ATE Ø 25,4 ATE Ø 25,4 ohne Bremsflüssigkeitsbehälter ATE Ø 25,4

VAUXHALL - INSIGNIA Mk I (A) Schrägheck (G09) 07/08→05/17

 **Hauptbremszylinder**

1.6 CDTI 1.6 Turbo	100 125 - 132	07/15→05/17 01/09→05/17		für Rechtslenker			ATE Ø 25,4 ohne Bremsflüssigkeitsbehälter
1.8 2.0 Biturbo CDTI 2.0 Biturbo CDTI 4x4 2.0 CDTI	103 143 143 81 - 140	07/08→05/17 03/12→05/17 03/12→05/17 07/08→05/17					
2.0 CDTI 4x4 2.0 Turbo 2.0 Turbo 4x4 2.8 V6 Turbo 4x4 2.8 VXR	125 - 140 162 162 191 239	05/09→05/17 07/08→05/17 07/08→05/17 07/08→05/17 07/09→05/17					
2.0 CDTI	88	03/12→03/16		03/13→; für Linkslenker	03.2125-0421.3	011125	ATE Ø 25,4
				03/13→; für Rechtslenker	24.4155-0201.3	011125	ATE Ø 25,4 ohne Bremsflüssigkeitsbehälter
2.0 CDTI 4x4	118	07/08→05/17		06/10→; für Linkslenker	03.2125-0421.3	010934	ATE Ø 25,4
				06/10→; für Rechtslenker	24.4155-0201.3	011125	ATE Ø 25,4 ohne Bremsflüssigkeitsbehälter
2.0 Turbo	184	07/11→05/17		für Linkslenker	03.2125-0421.3	010934	ATE Ø 25,4
				04/14→; für Rechtslenker	24.4155-0201.3	011125	ATE Ø 25,4 ohne Bremsflüssigkeitsbehälter

VAUXHALL - INSIGNIA Mk I (A) Sports Tourer (G09) 07/08→05/17

 **Bremskraftverstärker**

1.4	103	04/11→05/17		06/11→; für Linkslenker			ATE Ø 9 / 8" pneumatisch
1.4 LPG 1.6 1.6 CDTI 1.6 Turbo	103 85 100 125 - 132	07/12→05/17 07/08→07/12 07/15→05/17 01/09→05/17		für Linkslenker	03.7858-0732.4	300272	ATE Ø 9 / 8" pneumatisch
1.8 2.0 Biturbo CDTI 2.0 Biturbo CDTI 4x4 2.0 CDTI	103 143 143 81 - 140	07/08→05/17 03/12→05/17 03/12→05/17 07/08→05/17					
2.0 CDTI 4x4 2.0 Turbo 2.0 Turbo 4x4	125 - 140 162 - 184 162	05/09→05/17 07/08→05/17 07/08→05/17					
2.0 CDTI	88	03/12→03/16		03/13→; für Linkslenker	03.7858-0732.4	300272	ATE Ø 9 / 8" pneumatisch
2.0 CDTI 4x4	118	07/08→05/17		06/10→; für Linkslenker	03.7858-0732.4	300272	ATE Ø 9 / 8" pneumatisch

 **Hauptbremszylinder**

1.4	103	04/11→05/17		06/11→; für Linkslenker			ATE Ø 25,4
				06/11→; für Rechtslenker	24.4155-0201.3	011125	ATE Ø 25,4 ohne Bremsflüssigkeitsbehälter
1.4 LPG 1.6 1.6 CDTI 1.6 Turbo	103 85 100 125 - 132	07/12→05/17 07/08→07/12 07/15→05/17 01/09→05/17		für Linkslenker	03.2125-0421.3	010934	ATE Ø 25,4
1.8 2.0 Biturbo CDTI 2.0 Biturbo CDTI 4x4 2.0 CDTI	103 143 143 81 - 140	07/08→05/17 03/12→05/17 03/12→05/17 07/08→05/17		für Rechtslenker	24.4155-0201.3	011125	ATE Ø 25,4 ohne Bremsflüssigkeitsbehälter
2.0 CDTI 4x4 2.0 Turbo 2.0 Turbo 4x4 2.8 V6 Turbo 2.8 VXR	125 - 140 162 162 191 239	05/09→05/17 07/08→05/17 07/08→05/17 08/08→05/17 07/09→05/17					
2.0 CDTI	88	03/12→03/16		03/13→; für Linkslenker	03.2125-0421.3	010934	ATE Ø 25,4
				03/13→; für Rechtslenker	24.4155-0201.3	011125	ATE Ø 25,4 ohne Bremsflüssigkeitsbehälter
2.0 CDTI 4x4	118	07/08→05/17		06/10→; für Linkslenker	03.2125-0421.3	010934	ATE Ø 25,4
				06/10→; für Rechtslenker	24.4155-0201.3	011125	ATE Ø 25,4 ohne Bremsflüssigkeitsbehälter
2.0 Turbo	184	07/11→05/17		für Linkslenker	03.2125-0421.3	010934	ATE Ø 25,4
				04/14→; für Rechtslenker	24.4155-0201.3	011125	ATE Ø 25,4 ohne Bremsflüssigkeitsbehälter

VAUXHALL - INSIGNIA Mk I (A) Stufenheck (G09) 07/08→05/17

Bremskraftverstärker

1.4	103	04/11→05/17		06/11→; für Linkslenker	03.7858-0732.4	300272	ATE Ø 9 / 8" pneumatisch
1.4 LPG	103	07/12→05/17		für Linkslenker	03.7858-0732.4	300272	ATE Ø 9 / 8" pneumatisch
1.6	85	07/08→07/12					
1.6 CDTi	100	07/15→05/17					
1.6 Turbo	132	01/09→05/17					
1.8	103	07/08→05/17					
2.0 Biturbo CDTI	143	03/12→05/17					
2.0 Biturbo CDTI 4x4	143	03/12→05/17					
2.0 CDTI	96 -	07/08→05/17					
	140						
2.0 CDTI 4x4	125 -	05/09→05/17					
	140						
2.0 Turbo	162	07/08→05/17					
2.0 Turbo 4x4	162 -	07/08→05/17					
	184						
2.0 CDTI 4x4	118	07/08→05/17		06/10→; für Linkslenker	03.7858-0732.4	300272	ATE Ø 9 / 8" pneumatisch
2.0 Turbo	184	09/11→05/17		04/14→; für Linkslenker	03.7858-0732.4	300272	ATE Ø 9 / 8" pneumatisch

Hauptbremszylinder













1.4	103	04/11→05/17		06/11→; für Linkslenker	03.2125-0421.3	010934	ATE Ø 25,4
				06/11→; für Rechtslenker	24.4155-0201.3	011125	ATE Ø 25,4 ohne Bremsflüssigkeitsbehälter
1.4 LPG	103	07/12→05/17		für Linkslenker	03.2125-0421.3	010934	ATE Ø 25,4
1.6	85	07/08→07/12					
1.6 CDTi	100	07/15→05/17		für Rechtslenker	24.4155-0201.3	011125	ATE Ø 25,4 ohne Bremsflüssigkeitsbehälter
1.6 Turbo	132	01/09→05/17					
1.8	103	07/08→05/17					
2.0 Biturbo CDTI	143	03/12→05/17					
2.0 Biturbo CDTI 4x4	143	03/12→05/17					
2.0 CDTI	96 -	07/08→05/17					
	140						
2.0 CDTI 4x4	125 -	05/09→05/17					
	140						
2.0 Turbo	162	07/08→05/17					
2.0 Turbo 4x4	162 -	07/08→05/17					
	184						
2.8 V6 Turbo 4x4	191	07/08→05/17					
2.8 VXR	239	07/09→05/17					
2.0 CDTI 4x4	118	07/08→05/17		06/10→; für Linkslenker	03.2125-0421.3	010934	ATE Ø 25,4
				06/10→; für Rechtslenker	24.4155-0201.3	011125	ATE Ø 25,4 ohne Bremsflüssigkeitsbehälter
2.0 Turbo	184	09/11→05/17		04/14→; für Linkslenker	03.2125-0421.3	010934	ATE Ø 25,4
				04/14→; für Rechtslenker	24.4155-0201.3	011125	ATE Ø 25,4 ohne Bremsflüssigkeitsbehälter













VAUXHALL - MERIVA A (X03) 01/03→06/10

Hauptbremszylinder











1.3 CDTI	51	04/05→06/10		→ 44999999; - ESP	24.2123-1764.3	010824	TRW Ø 23,8
1.6 Turbo	132	05/06→06/10					
1.7 DTI	55	06/03→06/10		54000001→ 74237191; + ESP	24.2123-1784.3	011164	BOS Ø 23,8 ohne Bremsflüssigkeitsbehälter
1.8 i 16V	92	05/03→06/10		74237192→; → 05/10; + ESP	24.4123-1717.3	010985	TRW Ø 23,8 ohne Bremsflüssigkeitsbehälter
1.3 CDTI	55	01/03→10/09		09/03→; → 44999999; - ESP	24.2123-1764.3	010824	TRW Ø 23,8
				54000001→ 74237191; + ESP	24.2123-1784.3	011164	BOS Ø 23,8 ohne Bremsflüssigkeitsbehälter
				74237192→; + ESP	24.4123-1717.3	010985	TRW Ø 23,8 ohne Bremsflüssigkeitsbehälter
1.4 16V Twinport	66	01/03→06/10		07/04→; → 44999999; - ESP	24.2123-1764.3	010824	TRW Ø 23,8
				54000001→ 74237191; + ESP	24.2123-1784.3	011164	BOS Ø 23,8 ohne Bremsflüssigkeitsbehälter
				74237192→; → 05/10; + ESP	24.4123-1717.3	010985	TRW Ø 23,8 ohne Bremsflüssigkeitsbehälter
1.6 i	64	01/03→06/10		05/03→; → 44999999; - ESP	24.2123-1764.3	010824	TRW Ø 23,8
				54000001→ 74237191; + ESP	24.2123-1784.3	011164	BOS Ø 23,8 ohne Bremsflüssigkeitsbehälter
				74237192→; → 05/10; + ESP	24.4123-1717.3	010985	TRW Ø 23,8 ohne Bremsflüssigkeitsbehälter
1.6 i 16V	74	01/03→09/05		05/03→; → 44999999; - ESP	24.2123-1764.3	010824	TRW Ø 23,8
				54000001→ 74237191; + ESP	24.2123-1784.3	011164	BOS Ø 23,8 ohne Bremsflüssigkeitsbehälter
				74237192→; + ESP	24.4123-1717.3	010985	TRW Ø 23,8 ohne Bremsflüssigkeitsbehälter











→













	kw					! #		
VAUXHALL - MERIVA A (X03) 01/03→06/10								
 Hauptbremszylinder								
1.6 i 16V Twinport	77	05/03→06/10		01/06→; → 44999999; - ESP		24.2123-1764.3	010824	TRW Ø 23,8
				54000001→ 74237191; + ESP		24.2123-1784.3	011164	BOS Ø 23,8 ohne Bremsflüssigkeitsbehälter
				74237192→; → 05/10; + ESP		24.4123-1717.3	010985	TRW Ø 23,8 ohne Bremsflüssigkeitsbehälter
1.7 CDTi	74	09/03→08/05		→ 44999999; - ESP		24.2123-1764.3	010824	TRW Ø 23,8
				54000001→ 74237191; + ESP		24.2123-1784.3	011164	BOS Ø 23,8 ohne Bremsflüssigkeitsbehälter
				74237192→; + ESP		24.4123-1717.3	010985	TRW Ø 23,8 ohne Bremsflüssigkeitsbehälter
VAUXHALL - MOKKA / MOKKA X (J13) 06/12→								
 Hauptbremszylinder								
1.4 1.4 4x4 1.6 1.6 CDTi 1.6 CDTi 1.6 CDTi 4x4 1.7 CDTi 1.7 CDTi 4x4	103 103 - 112 85 100 81 100 96 96	04/13→ 06/12→ 06/12→ 01/15→ 06/15→ 01/15→ 06/12→ 06/12→		für Linkslenker		24.4123-1738.3	011124	Ø 23,8 ohne Bremsflüssigkeitsbehälter
VAUXHALL - MOVANO Mk I (A) Chassis/Cab (X70) 10/98→12/10								
 Hauptbremszylinder								
2.2 DTI	66	09/00→05/10		→ 08/03; + ABS		24.2025-1706.3	010676	Ø 25,4
				→ 01/10; - ABS		24.2025-1708.3	010692	Ø 25,4
				09/03→; + ABS; → 08/06		24.2123-1759.3	010768	BOS Ø 23,8
2.5 CDTi	73	11/03→12/06		- ABS		24.2025-1708.3	010692	Ø 25,4
				+ ABS		24.2123-1759.3	010768	BOS Ø 23,8
2.5 D	59	10/98→08/02		→ 09/00; + ABS		24.2025-1706.3	010676	Ø 25,4
				→ 09/00; - ABS		24.2025-1708.3	010692	Ø 25,4
2.5 DTI	84	01/01→12/06		→ 08/03; + ABS		24.2025-1706.3	010676	Ø 25,4
				- ABS		24.2025-1708.3	010692	Ø 25,4
				09/03→; + ABS; → 08/06		24.2123-1759.3	010768	BOS Ø 23,8
2.8 DTI	84	10/98→10/01		+ ABS		24.2025-1706.3	010676	Ø 25,4
				- ABS		24.2025-1708.3	010692	Ø 25,4
3.0 DTi	100	10/03→05/10		→ 01/10; - ABS		24.2025-1708.3	010692	Ø 25,4
				→ 08/06; + ABS		24.2123-1759.3	010768	BOS Ø 23,8
VAUXHALL - MOVANO Mk I (A) Combi (X70) 10/98→05/10								
 Hauptbremszylinder								
1.9 DTI 2.2 DTI	60 66	10/01→05/10 09/00→05/10		→ 08/03; + ABS		24.2025-1706.3	010676	Ø 25,4
				→ 01/10; - ABS		24.2025-1708.3	010692	Ø 25,4
				09/03→; + ABS; → 08/06		24.2123-1759.3	010768	BOS Ø 23,8
2.5 D 2.8 DTI	59 84	10/98→09/00 10/98→10/01		+ ABS		24.2025-1706.3	010676	Ø 25,4
				- ABS		24.2025-1708.3	010692	Ø 25,4
2.5 DTI	84	10/01→08/09		→ 08/03; + ABS		24.2025-1706.3	010676	Ø 25,4
				- ABS		24.2025-1708.3	010692	Ø 25,4
				09/03→; + ABS; → 08/06		24.2123-1759.3	010768	BOS Ø 23,8
3.0 DTi	100	10/03→05/10		→ 01/10; - ABS		24.2025-1708.3	010692	Ø 25,4
				→ 08/06; + ABS		24.2123-1759.3	010768	BOS Ø 23,8
VAUXHALL - MOVANO Mk I (A) Van (X70) 10/98→12/10								
 Hauptbremszylinder								
1.9 DTI 2.2 DTI 2.5 DTI	60 66 84	10/01→05/10 09/00→05/10 10/01→05/10		→ 08/03; + ABS		24.2025-1706.3	010676	Ø 25,4
				→ 01/10; - ABS		24.2025-1708.3	010692	Ø 25,4
				09/03→; + ABS; → 08/06		24.2123-1759.3	010768	BOS Ø 23,8
2.5	73	11/03→12/06		- ABS		24.2025-1708.3	010692	Ø 25,4
				+ ABS		24.2123-1759.3	010768	BOS Ø 23,8
2.5 D 2.8 TDI	59 84	10/98→09/00 10/98→10/01		+ ABS		24.2025-1706.3	010676	Ø 25,4
				- ABS		24.2025-1708.3	010692	Ø 25,4
3.0 DTi	100	10/03→05/10		→ 01/10; - ABS		24.2025-1708.3	010692	Ø 25,4
				→ 08/06; + ABS		24.2123-1759.3	010768	BOS Ø 23,8













	kw					! #		
VAUXHALL - MOVANO Mk III (C) Chassis/Cab (U9) 12/21→								
 Hauptbremszylinder								
2.2 D	103 - 121	12/21→10/23		- DSC		24.4125-1717.3	011157	BOS Ø 25,4 ohne Bremsflüssigkeitsbehälter
				Nutzlast-Code: Nutzlast schwer / 16Q; + DSC		24.4125-1718.3	011158	BOS Ø 25,4 ohne Bremsflüssigkeitsbehälter
				Nutzlast-Code: Nutzlast leicht / 12Q / 14Q / 16Q; + DSC		24.4125-1718.3	011158	BOS Ø 25,4 ohne Bremsflüssigkeitsbehälter
				Nutzlast-Code: Nutzlast schwer / 20Q		24.4126-1705.3	011160	Ø 27 ohne Bremsflüssigkeitsbehälter
VAUXHALL - MOVANO Mk III (C) VAN (U9) 12/21→								
 Hauptbremszylinder								
2.2 D	88 - 132	12/21→		- DSC		24.4125-1717.3	011157	BOS Ø 25,4 ohne Bremsflüssigkeitsbehälter
Movano-e	100	12/21→10/23		Nutzlast-Code: Nutzlast leicht / 12Q / 14Q / 16Q; + DSC		24.4125-1718.3	011158	BOS Ø 25,4 ohne Bremsflüssigkeitsbehälter
				Nutzlast-Code: Nutzlast schwer / 16Q; + DSC		24.4125-1718.3	011158	BOS Ø 25,4 ohne Bremsflüssigkeitsbehälter
				Nutzlast-Code: Nutzlast schwer / 20Q		24.4126-1705.3	011160	Ø 27 ohne Bremsflüssigkeitsbehälter
VAUXHALL - OMEGA (B) Kombi (V94) 12/93→06/03								
 Hauptbremszylinder								
2.0 16V	100	03/94→07/01		W1000001→; → 09/99; für Linkslenker; + ESP		24.2125-1740.3	010971	TRW Ø 25,4
2.0 DTI 16V	74	01/98→09/00		→ 08/00; für Linkslenker; + ESP		24.2125-1740.3	010971	TRW Ø 25,4
2.0 Dualfuel	100	01/99→07/01		W1000001→; für Linkslenker; + ESP		24.2125-1740.3	010971	TRW Ø 25,4
2.5 TD	96	04/94→07/01						
2.2 16V	106	02/94→06/03		10/99→; für Linkslenker; + ESP		24.2125-1740.3	010971	TRW Ø 25,4
2.2 DTI 16V	88	08/00→06/03		09/00→; für Linkslenker; + ESP		24.2125-1740.3	010971	TRW Ø 25,4
2.5 V6	125	03/94→09/00		W1000001→; für Linkslenker; nicht für Sonderfahrzeuge; + ESP		24.2125-1740.3	010971	TRW Ø 25,4
3.0 V6	155	07/94→07/00						
2.6 V6	132	08/00→06/03		09/00→; für Linkslenker; nicht für Sonderfahrzeuge; + ESP		24.2125-1740.3	010971	TRW Ø 25,4
3.2 V6	160	02/01→06/03		für Linkslenker; nicht für Sonderfahrzeuge; + ESP		24.2125-1740.3	010971	TRW Ø 25,4
VAUXHALL - OMEGA (B) Stufenheck (V94) 12/93→07/03								
 Hauptbremszylinder								
2.0 16V	100	03/94→07/01		W1000001→; → 09/99; für Linkslenker; + ESP		24.2125-1740.3	010971	TRW Ø 25,4
2.0 DTI 16V	74	01/98→09/00		→ 08/00; für Linkslenker; + ESP		24.2125-1740.3	010971	TRW Ø 25,4
2.0 Dualfuel	100	05/98→07/01		W1000001→; für Linkslenker; + ESP		24.2125-1740.3	010971	TRW Ø 25,4
2.5 TD	96	04/94→07/01						
2.2 16V	106	01/94→06/03		10/99→; für Linkslenker; + ESP		24.2125-1740.3	010971	TRW Ø 25,4
2.2 DTI 16V	88	08/00→07/03		09/00→; für Linkslenker; + ESP		24.2125-1740.3	010971	TRW Ø 25,4
2.5 V6	125	03/94→09/00		W1000001→; für Linkslenker; nicht für Sonderfahrzeuge; + ESP		24.2125-1740.3	010971	TRW Ø 25,4
3.0 V6	155	04/94→07/00						
2.6 V6	132	08/00→07/03		09/00→; für Linkslenker; nicht für Sonderfahrzeuge; + ESP		24.2125-1740.3	010971	TRW Ø 25,4
3.2 V6	160	02/01→07/03		für Linkslenker; nicht für Sonderfahrzeuge; + ESP		24.2125-1740.3	010971	TRW Ø 25,4
VAUXHALL - SIGNUM (Z03) 03/03→10/08								
 Hauptbremszylinder								
1.8	90	06/03→07/05		für Linkslenker; + ESP		24.2125-1732.3	010827	TRW Ø 25,4
1.9 CDTi	88	04/04→03/08						
1.9 CDTi 16V	110	04/04→03/08						
2.0 DTI	74	05/03→04/04						
2.2 DTI	92	05/03→05/08						
2.2 i	114	05/03→05/08						
3.0 CDTi	130	05/03→05/08						
3.2 V6	155	05/03→05/08						
1.8	103	08/05→05/08		09/05→; für Linkslenker; + ESP		24.2125-1732.3	010827	TRW Ø 25,4
2.0 i Turbo	129	03/03→10/08		05/03→; für Linkslenker; → 05/08; + ESP		24.2125-1732.3	010827	TRW Ø 25,4
3.0 V6 CDTi	135	07/05→06/08		09/05→ 05/08; für Linkslenker; + ESP		24.2125-1732.3	010827	TRW Ø 25,4
VAUXHALL - TIGRA Mk I (S93) 07/94→12/00								
 Hauptbremszylinder								
1.4 16V	66	07/94→12/00		für Linkslenker; - ABS		24.2120-0702.3	010361	nicht für Delco Ø 20,6
→								











	kW				! #		
VAUXHALL - TIGRA Mk I (S93) 07/94→12/00							
Hauptbremszylinder							
1.4 16V	66	07/94→12/00		für Linkslenker; + ABS	24.2120-1714.3	010455	Ø 20,6
1.6 16V	78	07/94→12/00		→ 08/98; für Linkslenker; - ABS	24.2120-0702.3	010361	nicht für Delco Ø 20,6
				→ 08/98; für Linkslenker; + ABS	24.2120-1714.3	010455	Ø 20,6
VAUXHALL - TIGRA TwinTop (X04) 06/04→08/09							
Hauptbremszylinder							
1.3 CDTI	51	06/04→08/09		- ESP	24.2123-1767.3	010844	BOS Ø 23,8
1.4	66	06/04→08/09					
1.8	92	06/04→08/09					
VAUXHALL - VECTRA (B) CC (J96) 08/95→07/03							
Bremskraftverstärker							
2.0 Dualfuel	100	08/98→01/01		für Linkslenker; → W1285446	03.7745-3003.4	300157	ATE Ø 8 / 7" pneumatisch
2.0 i 16V	100	10/95→01/01					
2.5 i GSi	143	03/98→07/00		für Linkslenker	03.7745-3003.4	300157	ATE Ø 8 / 7" pneumatisch
2.5 i V6	125	09/95→08/00					
2.6 i V6	125	09/00→07/03		→ 04/02; für Linkslenker	03.7745-3003.4	300157	ATE Ø 8 / 7" pneumatisch
Hauptbremszylinder							
1.6 i	55	08/95→10/01		09/95→; → W1999999; für Rechtslenker	24.2122-1724.3	010561	Ø 22,2
1.6 i 16V	74	08/95→10/01		09/95→; → V7999999; für Linkslenker	24.2122-1724.3	010561	Ø 22,2
				09/95→; → V5999999; für Linkslenker	24.2122-1724.3	010561	Ø 22,2
				09/95→; → V1999999; für Linkslenker	24.2122-1724.3	010561	Ø 22,2
				09/95→; → W7999999; für Rechtslenker	24.2122-1724.3	010561	Ø 22,2
				09/95→; → W5999999; für Rechtslenker	24.2122-1724.3	010561	Ø 22,2
				W7000001→ W7999999; für Linkslenker	24.2123-1777.3	010943	Ø 23,8
				W5000001→ W5999999; für Linkslenker	24.2123-1777.3	010943	Ø 23,8
				W1000001→ W1999999; für Linkslenker	24.2123-1777.3	010943	Ø 23,8
1.8 Dualfuel	92	09/00→07/03		→ W5999999; für Rechtslenker	24.2122-1724.3	010561	Ø 22,2
1.8 i 16V	85 - 92	09/95→07/03		→ W1999999; für Rechtslenker	24.2122-1724.3	010561	Ø 22,2
2.0 DTi 16V	74	06/97→10/01		→ V7999999; für Linkslenker	24.2122-1724.3	010561	Ø 22,2
				→ W7999999; für Rechtslenker	24.2122-1724.3	010561	Ø 22,2
				→ V5999999; für Linkslenker	24.2122-1724.3	010561	Ø 22,2
				→ V1999999; für Linkslenker	24.2122-1724.3	010561	Ø 22,2
				W7000001→ W7999999; für Linkslenker	24.2123-1777.3	010943	Ø 23,8
				W5000001→ W5999999; für Linkslenker	24.2123-1777.3	010943	Ø 23,8
				W1000001→ W1999999; für Linkslenker	24.2123-1777.3	010943	Ø 23,8
2.0 Di 16V	60	08/95→10/01		11/96→; → V1999999; für Linkslenker	24.2122-1724.3	010561	Ø 22,2
				11/96→; → W7999999; für Rechtslenker	24.2122-1724.3	010561	Ø 22,2
				11/96→; → W1999999; für Rechtslenker	24.2122-1724.3	010561	Ø 22,2
				11/96→; → V5999999; für Linkslenker	24.2122-1724.3	010561	Ø 22,2
				11/96→; → W5999999; für Rechtslenker	24.2122-1724.3	010561	Ø 22,2
				11/96→; → V7999999; für Linkslenker	24.2122-1724.3	010561	Ø 22,2
				W7000001→ W7999999; für Linkslenker	24.2123-1777.3	010943	Ø 23,8
				W5000001→ W5999999; für Linkslenker	24.2123-1777.3	010943	Ø 23,8
				W1000001→ W1999999; für Linkslenker	24.2123-1777.3	010943	Ø 23,8
2.0 Dualfuel	100	08/98→01/01		→ W7154258; für Linkslenker	03.2123-1622.3	010470	Ø 23,8
2.0 i 16V	100	10/95→01/01		→ W1285446; für Linkslenker	03.2123-1622.3	010470	Ø 23,8
2.5 i GSi	143	03/98→07/00					
2.5 i V6	125	09/95→08/00		→ W5276825; für Linkslenker	03.2123-1622.3	010470	Ø 23,8
VAUXHALL - VECTRA (B) Kombi (J96) 08/95→03/02							
Bremskraftverstärker							
2.0 Dualfuel	100	10/98→01/01		für Linkslenker; → W1285446	03.7745-3003.4	300157	ATE Ø 8 / 7" pneumatisch
2.0 i 16V	100	10/95→01/01					
2.5 i V6	125	11/96→08/00		für Linkslenker	03.7745-3003.4	300157	ATE Ø 8 / 7" pneumatisch
2.6 i V6	125	09/00→03/02					
Hauptbremszylinder							
1.8 Dualfuel	92	09/00→03/02		→ V1999999; für Linkslenker	24.2122-1724.3	010561	Ø 22,2
1.8 i 16V	85 - 92	09/96→03/02		→ V7999999; für Linkslenker	24.2122-1724.3	010561	Ø 22,2
				→ W1999999; für Rechtslenker	24.2122-1724.3	010561	Ø 22,2
				→ V5999999; für Linkslenker	24.2122-1724.3	010561	Ø 22,2
				→ W7999999; für Rechtslenker	24.2122-1724.3	010561	Ø 22,2
→							











	kw					! #		
VAUXHALL - VECTRA (B) Kombi (J96) 08/95→03/02								
 Hauptbremszylinder								
1.8 Dualfuel 1.8 i 16V	92 85 - 92	09/00→03/02 09/96→03/02	→ W5999999; für Rechtslenker	24.2122-1724.3	010561	Ø 22,2		
			W7000001→ W7999999; für Linkslenker	24.2123-1777.3	010943	Ø 23,8		
			W5000001→ W5999999; für Linkslenker	24.2123-1777.3	010943	Ø 23,8		
			W1000001→ W1999999; für Linkslenker	24.2123-1777.3	010943	Ø 23,8		
2.0 DI 16V	60	08/95→10/01	11/96→; → W7999999; für Rechtslenker	24.2122-1724.3	010561	Ø 22,2		
			11/96→; → W5999999; für Rechtslenker	24.2122-1724.3	010561	Ø 22,2		
			11/96→; → V1999999; für Linkslenker	24.2122-1724.3	010561	Ø 22,2		
			11/96→; → V7999999; für Linkslenker	24.2122-1724.3	010561	Ø 22,2		
			11/96→; → W1999999; für Rechtslenker	24.2122-1724.3	010561	Ø 22,2		
			11/96→; → V5999999; für Linkslenker	24.2122-1724.3	010561	Ø 22,2		
			W7000001→ W7999999; für Linkslenker	24.2123-1777.3	010943	Ø 23,8		
			W5000001→ W5999999; für Linkslenker	24.2123-1777.3	010943	Ø 23,8		
2.0 DTI 16V	74	08/95→10/01	06/97→; → V7999999; für Linkslenker	24.2122-1724.3	010561	Ø 22,2		
			06/97→; → W7999999; für Rechtslenker	24.2122-1724.3	010561	Ø 22,2		
			06/97→; → V5999999; für Linkslenker	24.2122-1724.3	010561	Ø 22,2		
			06/97→; → V1999999; für Linkslenker	24.2122-1724.3	010561	Ø 22,2		
			06/97→; → W5999999; für Rechtslenker	24.2122-1724.3	010561	Ø 22,2		
			06/97→; → W1999999; für Rechtslenker	24.2122-1724.3	010561	Ø 22,2		
			W7000001→ W7999999; für Linkslenker	24.2123-1777.3	010943	Ø 23,8		
			W5000001→ W5999999; für Linkslenker	24.2123-1777.3	010943	Ø 23,8		
2.0 Dualfuel 2.0 i 16V 2.5 i V6	100 100 125	10/98→01/01 10/95→01/01 11/96→08/00	→ W1285446; für Linkslenker	03.2123-1622.3	010470	Ø 23,8		
			→ W5276825; für Linkslenker	03.2123-1622.3	010470	Ø 23,8		
			→ W7154258; für Linkslenker	03.2123-1622.3	010470	Ø 23,8		
VAUXHALL - VECTRA (B) Stufenheck (J96) 08/95→03/02								
 Bremskraftverstärker								
2.0 Dualfuel 2.0 i 16V	100 100	05/98→01/01 10/95→01/01	für Linkslenker; → W1285446	03.7745-3003.4	300157	ATE Ø 8 / 7" pneumatisch		
			für Linkslenker	03.7745-3003.4	300157	ATE Ø 8 / 7" pneumatisch		
2.5 i GSi 2.5 i V6 2.6 i V6	143 125 125	03/98→07/00 09/95→08/00 09/00→03/02	für Linkslenker	03.7745-3003.4	300157	ATE Ø 8 / 7" pneumatisch		
 Hauptbremszylinder								
1.6 i 1.6 i 16V	55 74	08/95→10/01 08/95→10/01	09/95→; → V7999999; für Linkslenker	24.2122-1724.3	010561	Ø 22,2		
			09/95→; → W7999999; für Rechtslenker	24.2122-1724.3	010561	Ø 22,2		
			09/95→; → V5999999; für Linkslenker	24.2122-1724.3	010561	Ø 22,2		
			09/95→; → V1999999; für Linkslenker	24.2122-1724.3	010561	Ø 22,2		
			09/95→; → W5999999; für Rechtslenker	24.2122-1724.3	010561	Ø 22,2		
			09/95→; → W1999999; für Rechtslenker	24.2122-1724.3	010561	Ø 22,2		
			W5000001→ W5999999; für Linkslenker	24.2123-1777.3	010943	Ø 23,8		
			W1000001→ W1999999; für Linkslenker	24.2123-1777.3	010943	Ø 23,8		
1.8 Dualfuel 1.8 i 16V	92 85 - 92	09/00→03/02 10/95→03/02	→ V1999999; für Linkslenker	24.2122-1724.3	010561	Ø 22,2		
			→ V7999999; für Linkslenker	24.2122-1724.3	010561	Ø 22,2		
			→ W1999999; für Rechtslenker	24.2122-1724.3	010561	Ø 22,2		
			→ V5999999; für Linkslenker	24.2122-1724.3	010561	Ø 22,2		
			→ W7999999; für Rechtslenker	24.2122-1724.3	010561	Ø 22,2		
			→ W5999999; für Rechtslenker	24.2122-1724.3	010561	Ø 22,2		
			W5000001→ W5999999; für Linkslenker	24.2123-1777.3	010943	Ø 23,8		
			W1000001→ W1999999; für Linkslenker	24.2123-1777.3	010943	Ø 23,8		
2.0 DI 16V	60	08/95→10/01	11/96→; → W5999999; für Rechtslenker	24.2122-1724.3	010561	Ø 22,2		
			11/96→; → W7999999; für Rechtslenker	24.2122-1724.3	010561	Ø 22,2		
			11/96→; → W1999999; für Rechtslenker	24.2122-1724.3	010561	Ø 22,2		
			11/96→; → V5999999; für Linkslenker	24.2122-1724.3	010561	Ø 22,2		
			11/96→; → V7999999; für Linkslenker	24.2122-1724.3	010561	Ø 22,2		
			11/96→; → V1999999; für Linkslenker	24.2122-1724.3	010561	Ø 22,2		
			W5000001→ W5999999; für Linkslenker	24.2123-1777.3	010943	Ø 23,8		
			W1000001→ W1999999; für Linkslenker	24.2123-1777.3	010943	Ø 23,8		
→								









	kw			i 	! #		
VAUXHALL - VECTRA (B) Stufenheck (J96) 08/95→03/02							
 Hauptbremszylinder							
2.0 DI 16V	60	08/95→10/01		W7000001→W7999999; für Linkslenker		24.2123-1777.3 010943	Ø 23,8
2.0 DTI 16V	74	08/95→10/01		06/97→; → W5999999; für Rechtslenker		24.2122-1724.3 010561	Ø 22,2
				06/97→; → V7999999; für Linkslenker		24.2122-1724.3 010561	Ø 22,2
				06/97→; → V5999999; für Linkslenker		24.2122-1724.3 010561	Ø 22,2
				06/97→; → V1999999; für Linkslenker		24.2122-1724.3 010561	Ø 22,2
				06/97→; → W7999999; für Rechtslenker		24.2122-1724.3 010561	Ø 22,2
				06/97→; → W1999999; für Rechtslenker		24.2122-1724.3 010561	Ø 22,2
				W5000001→W5999999; für Linkslenker		24.2123-1777.3 010943	Ø 23,8
				W1000001→W1999999; für Linkslenker		24.2123-1777.3 010943	Ø 23,8
2.0 Dualfuel 2.0 i 16V 2.5 i GSi 2.5 i V6	100	05/98→01/01		→ W7154258; für Linkslenker		03.2123-1622.3 010470	Ø 23,8
	100	10/95→01/01		→ W5276825; für Linkslenker		03.2123-1622.3 010470	Ø 23,8
	143	03/98→07/00					
	125	09/95→08/00		→ W1285446; für Linkslenker		03.2123-1622.3 010470	Ø 23,8
VAUXHALL - VECTRA Mk II (C) (Z02) 01/00→10/08							
 Hauptbremszylinder							
1.8 1.8 16V 1.8 16V Dualfuel 1.9 CDTI 16V 2.0 DTI 16V 2.2 DTI 16V 3.0 CDTi 3.0 V6 CDTI 3.2 V6	103 90 90 110 74 92 135 130 155	01/06→07/08 04/02→07/08 04/02→07/08 04/04→08/08 04/02→10/08 04/02→10/08 08/05→07/08 06/03→08/05 06/03→07/08		für Linkslenker; + ESP		24.2125-1732.3 010827	TRW Ø 25,4
1.9 CDTI	88	04/02→09/08		04/04→; für Linkslenker; + ESP		24.2125-1732.3 010827	TRW Ø 25,4
2.0 16V Turbo	129	01/00→10/08		03/03→; für Linkslenker; + ESP		24.2125-1732.3 010827	TRW Ø 25,4
2.2 16V	108	01/02→10/08		04/02→; für Linkslenker; + ESP		24.2125-1732.3 010827	TRW Ø 25,4
2.2 direct	114	01/02→10/08		10/03→; für Linkslenker; + ESP		24.2125-1732.3 010827	TRW Ø 25,4
VAUXHALL - VECTRA Mk II (C) CC (Z02) 08/02→05/09							
 Hauptbremszylinder							
1.8 1.8 16V 1.8 16V Dualfuel 1.9 CDTI 16V 2.0 16V Turbo 2.0 DTI 16V 2.2 16V 2.2 direct 2.2 DTI 16V 3.0 CDTi 3.0 V6 CDTI 3.2 V6	103 90 90 110 129 74 108 114 92 135 130 155	01/06→07/08 08/02→07/08 08/02→07/08 04/04→07/08 03/03→07/08 08/02→07/08 08/02→07/08 10/03→08/05 08/02→07/08 08/05→07/08 06/03→08/05 08/02→07/08		für Linkslenker; + ESP		24.2125-1732.3 010827	TRW Ø 25,4
1.9 CDTI	88	08/02→07/08		04/04→; für Linkslenker; + ESP		24.2125-1732.3 010827	TRW Ø 25,4
VAUXHALL - VECTRA Mk II (C) Kombi (Z02) 10/03→05/09							
 Hauptbremszylinder							
1.8 1.8 16V 1.9 CDTI 2.0 16V Turbo 2.0 DTI 16V 2.2 direct 2.2 DTI 16V 3.0 CDTi 3.0 V6 CDTI 3.2 V6	103 90 88 129 74 114 92 135 130 155	01/06→07/08 10/03→08/05 04/04→07/08 10/03→07/08 10/03→07/08 10/03→07/08 10/03→07/08 08/05→07/08 10/03→08/05 10/03→08/05		für Linkslenker; + ESP		24.2125-1732.3 010827	TRW Ø 25,4
1.9 CDTI 16V	110	04/04→05/09		für Linkslenker; + ESP; → 10/08		24.2125-1732.3 010827	TRW Ø 25,4
VAUXHALL - VIVARO A Bus (X83) 08/01→07/14							
 Hauptbremszylinder							
1.9 DI 1.9 DTI	59 74	08/01→12/06 08/01→12/06		7V600001 / 7Y000001→; + ABS		24.2120-1748.3 010894	TRW Ø 20,6
2.0 16V	88	08/01→12/06		7V600001 / 7Y000001→; + ASR		24.2120-1753.3 010946	TRW Ø 20,6
				4V602168→6V699999; für Rechtslenker; - ASR		24.2125-1731.3 010826	TRW Ø 25,4
				7V600001 / 7Y000001→; + ABS		24.2120-1748.3 010894	TRW Ø 20,6
→				7V600001 / 7Y000001→; + ASR		24.2120-1753.3 010946	TRW Ø 20,6
				4V602168→6V699999; - ASR		24.2125-1731.3 010826	TRW Ø 25,4

	kw					! #		
VAUXHALL - VIVARO A Bus (X83) 08/01→07/14								
 Hauptbremszylinder								
2.0 CDTI	66 - 84	01/06→07/14		7V600001 / 7Y000001→; → 06/14; + ABS		24.2120-1748.3	010894	TRW Ø 20,6
2.0 ECOTEC 2.5 CDTI 2.5 DTI	86 107 99	08/06→07/14 01/06→07/14 07/03→07/14		7V600001 / 7Y000001→; → 06/14; + ASR 4V602168→ 6V699999; - ASR		24.2120-1753.3 24.2125-1731.3	010946 010826	TRW Ø 20,6 TRW Ø 25,4
VAUXHALL - VIVARO A Kasten (X83) 08/01→07/14								
 Hauptbremszylinder								
1.9 DI 1.9 DTI	59 74	08/01→12/06 08/01→12/06		7V600001 / 7Y000001→; + ABS 7V600001 / 7Y000001→; + ASR 4V602168→ 6V699999; für Rechtslenker; - ASR		24.2120-1748.3 24.2120-1753.3 24.2125-1731.3	010894 010946 010826	TRW Ø 20,6 TRW Ø 20,6 TRW Ø 25,4
2.0 16V	88	08/01→12/06		7V600001 / 7Y000001→; + ABS 7V600001 / 7Y000001→; + ASR 4V602168→ 6V699999; - ASR		24.2120-1748.3 24.2120-1753.3 24.2125-1731.3	010894 010946 010826	TRW Ø 20,6 TRW Ø 20,6 TRW Ø 25,4
2.0 CDTI 2.0 ECOTEC 2.5 CDTI 2.5 DTI	66 - 84 86 107 99	01/06→07/14 08/06→07/14 08/06→07/14 07/03→07/14		7V600001 / 7Y000001→; → 06/14; + ABS 7V600001 / 7Y000001→; → 06/14; + ASR 4V602168→ 6V699999; - ASR		24.2120-1748.3 24.2120-1753.3 24.2125-1731.3	010894 010946 010826	TRW Ø 20,6 TRW Ø 20,6 TRW Ø 25,4
VAUXHALL - VIVARO A Pritsche/Fahrgestell (X83) 04/03→07/14								
 Hauptbremszylinder								
2.0 16V 2.0 CDTI	88 66 - 84	04/03→07/14 01/06→07/14		7V600001 / 7Y000001→; → 06/14; + ABS 7V600001 / 7Y000001→; → 06/14; + ASR 4V602168→ 6V699999; - ASR		24.2120-1748.3 24.2120-1753.3 24.2125-1731.3	010894 010946 010826	TRW Ø 20,6 TRW Ø 20,6 TRW Ø 25,4
2.0 ECOTEC 2.5 CDTI	86 107	08/06→07/14 08/06→07/14		7V600001 / 7Y000001→; → 06/14; + ASR 4V602168→ 6V699999; - ASR		24.2125-1731.3 24.2120-1748.3	010826 010894	TRW Ø 25,4 TRW Ø 20,6
2.5 CDTI	99	04/03→07/06		7V600001 / 7Y000001→; + ABS 7V600001 / 7Y000001→; + ASR 4V602168→ 6V699999; - ASR		24.2120-1748.3 24.2120-1753.3 24.2125-1731.3	010894 010946 010826	TRW Ø 20,6 TRW Ø 20,6 TRW Ø 25,4
VAUXHALL - ZAFIRA A (T98) 11/98→08/05								
 Hauptbremszylinder								
1.6 16V 1.8 16V 1.8 Dualfuel 2.0 DI 16V	74 92 92 60	04/99→08/05 09/00→08/05 09/00→08/05 10/99→08/05		- ESP; → 06/05 + ESP; → 06/05		24.2123-1734.3 24.2123-1739.3	010640 010661	TRW Ø 23,8 Ø 23,8
1.6 CNG 1.8 16V 2.0 2.0 GSI Turbo	71 85 147 141	09/01→06/05 05/99→08/00 06/02→06/05 09/01→06/05		- ESP + ESP		24.2123-1734.3 24.2123-1739.3	010640 010661	TRW Ø 23,8 Ø 23,8
1.6 Dualfuel	74	11/98→08/05		04/99→; - ESP; → 06/05 04/99→; + ESP; → 06/05		24.2123-1734.3 24.2123-1739.3	010640 010661	TRW Ø 23,8 Ø 23,8
2.0 DTI 16V	74	04/99→08/05		06/00→; - ESP; → 06/05 06/00→; + ESP; → 06/05		24.2123-1734.3 24.2123-1739.3	010640 010661	TRW Ø 23,8 Ø 23,8
2.2 16V	108	11/98→08/04		09/00→; - ESP 09/00→; + ESP		24.2123-1734.3 24.2123-1739.3	010640 010661	TRW Ø 23,8 Ø 23,8
 Bremskraftregler								
1.6 16V 1.8 16V 1.8 Dualfuel 2.0 DI 16V	74 92 92 60	04/99→08/05 09/00→08/05 09/00→08/05 10/99→08/05		- ABS; → 06/05		03.6583-0085.3	320238	ATE lastabhängig 8/3 4x
1.6 CNG 1.8 16V 2.0 2.0 GSI Turbo	71 85 147 141	09/01→06/05 05/99→08/00 06/02→06/05 09/01→06/05		- ABS		03.6583-0085.3	320238	ATE lastabhängig 8/3 4x
1.6 Dualfuel	74	11/98→08/05		04/99→; - ABS; → 06/05		03.6583-0085.3	320238	ATE lastabhängig 8/3 4x
2.0 DTI 16V	74	04/99→08/05		06/00→; - ABS; → 06/05		03.6583-0085.3	320238	ATE lastabhängig 8/3 4x
2.2 16V	108	11/98→08/04		09/00→; - ABS		03.6583-0085.3	320238	ATE lastabhängig 8/3 4x
VAUXHALL - ZAFIRA Mk II (B) (A05) 04/05→11/14								
 Bremskraftverstärker								
1.6 1.7 CDTI →	77 - 85 81 - 92	07/05→11/14 01/08→11/14		für Linkslenker; + ESP		03.7863-7803.4	300237	ATE Ø 10" pneumatisch







	kw					! #		
VAUXHALL - ZAFIRA Mk II (B) (A05) 04/05→11/14								
 Bremskraftverstärker								
1.9 CDTI	88 - 110	07/05→11/14			für Linkslenker; + ESP		03.7863-7803.4 300237	ATE Ø 10" pneumatisch
2.0	147 - 176	07/05→11/14						
2.2	110	07/05→11/14						
1.8	88	04/13→11/14			06/13→; für Linkslenker; + ESP		03.7863-7803.4 300237	ATE Ø 10" pneumatisch
1.8	103	04/05→11/14			07/05→; für Linkslenker; + ESP		03.7863-7803.4 300237	ATE Ø 10" pneumatisch
 Hauptbremszylinder								
1.6	77	07/05→11/14			für Linkslenker; - ESP		03.4155-0153.3 010927	ATE Ø 25,4
2.0	147 - 176	07/05→11/14			für Linkslenker; + ESP		03.4155-0156.3 010862	ATE Ø 25,4
					→ 6G999999; für Rechtslenker		24.2125-1736.3 010904	TRW Ø 25,4
					72000001→; für Rechtslenker		24.4125-1703.3 010907	TRW Ø 25,4
1.6	85	12/07→11/14			für Linkslenker; - ESP		03.4155-0153.3 010927	ATE Ø 25,4
					für Linkslenker; + ESP		03.4155-0156.3 010862	ATE Ø 25,4
1.7 CDTI	81 - 92	01/08→11/14			für Linkslenker; - ESP		03.4155-0153.3 010927	ATE Ø 25,4
1.9 CDTI	88 - 110	07/05→11/14			für Rechtslenker		03.4155-0156.3 010862	ATE Ø 25,4
2.2	110	07/05→11/14			für Linkslenker; + ESP		03.4155-0156.3 010862	ATE Ø 25,4
1.8	88	04/13→11/14			06/13→; für Linkslenker; - ESP		03.4155-0153.3 010927	ATE Ø 25,4
					06/13→; für Linkslenker; + ESP		03.4155-0156.3 010862	ATE Ø 25,4
					06/13→; für Rechtslenker		24.4125-1703.3 010907	TRW Ø 25,4
1.8	103	04/05→11/14			07/05→; für Linkslenker; - ESP		03.4155-0153.3 010927	ATE Ø 25,4
					07/05→; für Linkslenker; + ESP		03.4155-0156.3 010862	ATE Ø 25,4
					07/05→; → 6G999999; für Rechtslenker		24.2125-1736.3 010904	TRW Ø 25,4
					72000001→; für Rechtslenker		24.4125-1703.3 010907	TRW Ø 25,4
VAUXHALL - ZAFIRA Mk III (P12) 10/11→08/18								
 Bremskraftverstärker								
1.4	88 - 103	10/11→08/18			11/11→; für Linkslenker		03.7858-0732.4 300272	ATE Ø 9 / 8" pneumatisch
1.6 CNG	110	10/11→08/18						
1.8	85 - 103	10/11→08/18						
2.0 CDTi	81 - 121	10/11→08/18						
1.6 CDTi	99 - 100	03/13→08/18			für Linkslenker		03.7858-0732.4 300272	ATE Ø 9 / 8" pneumatisch
1.6 SIDI	147	07/13→08/18						
2.0 BiTurbo CDTI	143	11/12→08/18						
2.0 CDTi	125	01/15→08/18						
 Hauptbremszylinder								
1.4	88 - 103	10/11→08/18			11/11→; für Linkslenker		03.2125-0421.3 010934	ATE Ø 25,4
1.6 CNG	110	10/11→08/18			11/11→; für Rechtslenker		24.4155-0201.3 011125	ATE Ø 25,4 ohne Bremsflüssigkeitsbehälter
1.8	85 - 103	10/11→08/18						
2.0 CDTi	81 - 121	10/11→08/18						
1.6 CDTi	99 - 100	03/13→08/18			für Linkslenker		03.2125-0421.3 010934	ATE Ø 25,4
1.6 SIDI	147	07/13→08/18			für Rechtslenker		24.4155-0201.3 011125	ATE Ø 25,4 ohne Bremsflüssigkeitsbehälter
2.0 CDTi	125	01/15→08/18						
2.0 BiTurbo CDTI	143	11/12→08/18			für Linkslenker		03.2125-0421.3 010934	ATE Ø 25,4
					12/12→; für Rechtslenker		24.4155-0201.3 011125	ATE Ø 25,4 ohne Bremsflüssigkeitsbehälter
VOLVO - C30 (533) 09/06→12/13								
 Bremskraftverstärker								
1.6	74	10/06→12/12			für Linkslenker		03.7863-4832.4 300289	ATE Ø 10" pneumatisch
1.6 D	80	10/06→12/12						
1.8	92	10/06→12/12						
2.0	107	10/06→12/12						
2.0 D	100	10/06→12/12						
2.0 FlexFuel	107	01/10→12/12						
2.4 i	125	10/06→12/12						
D5	120 - 132	10/06→12/12						
Electric	82 - 89	12/10→12/12						
→								









	kW			 	! #		
VOLVO - C30 (533) 09/06→12/13							
 Bremskraftverstärker							
T5	162 - 184	10/06→12/13		für Linkslenker		03.7863-4832.4 300289	ATE Ø 10" pneumatisch
1.8 FlexFuel	92	01/07→12/12		04/07→; für Linkslenker		03.7863-4832.4 300289	ATE Ø 10" pneumatisch
Pedalwegsensord, Bremspedal							
1.6	74	10/06→12/12				03.0655-0007.2 370007	ATE
1.6 D	80	10/06→12/12					
1.8	92	10/06→12/12					
2.0	107	10/06→12/12					
2.0 D	100	10/06→12/12					
2.0 FlexFuel	107	01/10→12/12					
2.4 i	125	10/06→12/12					
D5	120 - 132	10/06→12/12					
T5	162 - 184	10/06→12/13					
1.8 FlexFuel	92	01/07→12/12		04/07→		03.0655-0007.2 370007	ATE
Electric	82 - 89	12/10→12/12		für Linkslenker		03.0655-0007.2 370007	ATE
 Hauptbremszylinder							
1.6	74	10/06→12/12		für Linkslenker		03.2123-3593.3 010919	ATE Ø 23,8
1.6 D	80	10/06→12/12					
1.8	92	10/06→12/12					
2.0	107	10/06→12/12					
2.0 D	100	10/06→12/12					
2.0 FlexFuel	107	01/10→12/12					
2.4 i	125	10/06→12/12					
D5	120 - 132	10/06→12/12					
Electric	82 - 89	12/10→12/12					
T5	162 - 184	10/06→12/13					
1.8 FlexFuel	92	01/07→12/12		04/07→; für Linkslenker		03.2123-3593.3 010919	ATE Ø 23,8
D2	84	10/10→12/12		für Linkslenker		03.2123-3624.3 010956	ATE Ø 23,8
D3	110	10/10→12/12					
D4	130	10/10→12/12					
VOLVO - C70 I Cabriolet (873) 03/98→10/05							
Pedalwegsensord, Bremspedal							
2.0	132	03/98→10/05		01/99→		03.0655-0004.2 370004	ATE
2.0 T	166	03/98→10/05					
2.4	125	06/98→10/05					
2.4 T	142	03/98→10/05					
T5	176	03/98→10/05					
2.0 T	120	03/00→10/05				03.0655-0004.2 370004	ATE
2.4 T	147	07/02→10/05					
T5	180	07/02→10/05					
 Hauptbremszylinder							
2.0	132	03/98→10/05		→ 12/98; - ASR		03.2023-1084.3 010591	ATE Ø1 23,8 Ø2 20,6
2.0 T	166	03/98→10/05					
2.4	125	06/98→10/05		01/99→		03.2123-2164.3 010599	ATE Ø 23,8
2.4 T	142	03/98→10/05					
T5	176	03/98→10/05					
2.0 T	120	03/00→10/05				03.2123-2164.3 010599	ATE Ø 23,8
2.4 T	147	07/02→10/05					
T5	180	07/02→10/05					
VOLVO - C70 I Coupe (872) 03/97→09/02							
Pedalwegsensord, Bremspedal							
2.0	132	03/97→09/02		01/99→		03.0655-0004.2 370004	ATE
2.0 T	166	03/97→09/02					
2.4 T	142	03/97→09/02					
T-5	176	03/97→09/02					
2.0 T	120	03/00→09/02				03.0655-0004.2 370004	ATE
2.4	121	03/99→09/02					
2.4	125	05/99→09/02		11/99→		03.0655-0004.2 370004	ATE
 Hauptbremszylinder							
2.0	132	03/97→09/02		→ 12/98; für Linkslenker; - ASR		03.2023-1084.3 010591	ATE Ø1 23,8 Ø2 20,6
2.0 T	166	03/97→09/02					
2.4 T	142	03/97→09/02		01/99→		03.2123-2164.3 010599	ATE Ø 23,8
T-5	176	03/97→09/02					
2.0 T	120	03/00→09/02				03.2123-2164.3 010599	ATE Ø 23,8
2.4	121	03/99→09/02					
2.4	125	05/99→09/02		11/99→		03.2123-2164.3 010599	ATE Ø 23,8









	kw			 	! #		
VOLVO - C70 II Cabriolet (542) 03/06→12/13							
 Bremskraftverstärker							
2.0 D	100	01/08→10/09		06/08→; für Linkslenker		03.7863-4832.4 300289	ATE Ø 10" pneumatisch
2.4	103	03/06→10/09		für Linkslenker		03.7863-4832.4 300289	ATE Ø 10" pneumatisch
2.4 D	120	03/07→06/13					
2.4 i	125	03/06→10/09					
D5	132	03/06→06/13					
T5	162 - 169	03/06→06/13					
Pedalwegsensoren, Bremspedal							
2.0 D	100	01/08→10/09		06/08→; für Linkslenker		03.0655-0007.2 370007	ATE
				50576→; für Rechtslenker		03.0655-0007.2 370007	ATE
				06/08→; → 50575; für Rechtslenker		03.0655-0007.2 370007	ATE
2.4	103	03/06→10/09				03.0655-0007.2 370007	ATE
2.4 D	120	03/07→06/13					
2.4 i	125	03/06→10/09					
D5	132	03/06→06/13					
T5	162 - 169	03/06→06/13					
 Hauptbremszylinder							
2.0 D	100	01/08→10/09		06/08→; für Linkslenker		03.2123-3593.3 010919	ATE Ø 23,8
2.4	103	03/06→10/09		für Linkslenker		03.2123-3593.3 010919	ATE Ø 23,8
2.4 D	120	03/07→06/13					
2.4 i	125	03/06→10/09					
D5	132	03/06→06/13					
T5	162 - 169	03/06→06/13					
D3	110	10/10→06/13		für Linkslenker		03.2123-3624.3 010956	ATE Ø 23,8
D4	130	10/10→06/13					
VOLVO - S40 I (644) 07/95→12/04							
 Hauptbremszylinder							
1.6	80	03/99→12/03				24.2123-1746.3 010682	Ø 23,8
1.8	90	03/99→12/03					
1.8 i	90 - 92	03/98→12/03					
1.9 DI	70 - 85	03/99→12/03					
2.0 D	100	12/02→06/04					
2.0 T	120 - 121	07/00→12/03					
2.0 T4	147	07/00→12/03					
1.9 T4	147	05/97→07/00		→ 08/97		24.2122-1718.3 010517	Ø 22,2
2.0	100	07/95→12/03		09/97→		24.2123-1746.3 010682	Ø 23,8
2.0 T	118	10/97→12/03		→ 07/00		24.2123-1746.3 010682	Ø 23,8
VOLVO - S40 II (544) 12/03→12/12							
 Bremskraftverstärker							
1.6	74	01/05→12/12		→ 05/12; für Linkslenker		03.7863-4832.4 300289	ATE Ø 10" pneumatisch
1.6 D	81	01/05→12/12					
2.0	107	10/06→12/12					
2.0 F	107	10/09→12/12					
T5	169	03/07→12/12					
1.8	92	04/04→12/10		für Linkslenker		03.7863-4832.4 300289	ATE Ø 10" pneumatisch
2.0 CDI	98	07/05→12/06					
2.0 D	100	01/04→12/10					
2.4	103 - 125	01/04→12/12					
2.4 CDI	120	03/07→12/10					
D4	96	07/05→12/06					
D5	132	03/06→12/10					
T5	162	01/04→12/07					
T5 AWD	162 - 169	04/04→12/10					
1.8 FlexFuel	92	01/06→12/10		04/07→; für Linkslenker		03.7863-4832.4 300289	ATE Ø 10" pneumatisch
Pedalwegsensoren, Bremspedal							
1.6	74	01/05→12/12		→ 05/12		03.0655-0007.2 370007	ATE
1.6 D	81	01/05→12/12					
2.0	107	10/06→12/12					
2.0 F	107	10/09→12/12					
T5	169	03/07→12/12					
1.8	92	04/04→12/10				03.0655-0007.2 370007	ATE
2.0 CDI	98	07/05→12/06					
2.0 D	100	01/04→12/10					
→							











	kw					! #		
VOLVO - S40 II (544) 12/03→12/12								
Pedalwegsensord, Bremspedal								
2.4	103 - 125	01/04→12/12					03.0655-0007.2 370007	ATE
2.4 CDI	120	03/07→12/10						
D4	96	07/05→12/06						
D5	132	03/06→12/10						
T5	162	01/04→12/07						
T5 AWD	162 - 169	04/04→12/10						
1.8 FlexFuel	92	01/06→12/10		04/07→			03.0655-0007.2 370007	ATE
 Hauptbremszylinder								
1.6	74	01/05→12/12		→ 05/12; für Linkslenker			03.2123-3593.3 010919	ATE Ø 23,8
1.6 D	81	01/05→12/12						
2.0	107	10/06→12/12						
2.0 F	107	10/09→12/12						
T5	169	03/07→12/12						
1.8	92	04/04→12/10		für Linkslenker			03.2123-3593.3 010919	ATE Ø 23,8
2.0 CDI	98	07/05→12/06						
2.0 D	100	01/04→12/10						
2.4	103 - 125	01/04→12/12						
2.4 CDI	120	03/07→12/10						
D4	96	07/05→12/06						
D5	132	03/06→12/10						
T5	162	01/04→12/07						
T5 AWD	162 - 169	04/04→12/10						
1.8 FlexFuel	92	01/06→12/10		04/07→; für Linkslenker			03.2123-3593.3 010919	ATE Ø 23,8
D2	84	10/10→12/12		→ 05/12; für Linkslenker			03.2123-3624.3 010956	ATE Ø 23,8
D3	110	10/10→12/12						
D4	130	10/10→12/12						
VOLVO - S60 I (384) 07/00→04/10								
 Bremskraftverstärker								
2.0 T	132	07/00→04/10		09/01→ 12/01			03.7755-3402.4 300189	ATE Ø 9 / 8" pneumatisch
				01/02→ 01/09; - DSTC			03.7755-4702.4 300224	ATE Ø 9 / 8" pneumatisch
				01/02→ 01/09; + DSTC			03.7858-3532.4 300233	ATE Ø 9 / 8" pneumatisch
2.4	103	07/00→04/10		11/00→ 12/01			03.7755-3402.4 300189	ATE Ø 9 / 8" pneumatisch
2.4 T	147	07/00→04/10		01/02→ 01/09; - DSTC			03.7755-4702.4 300224	ATE Ø 9 / 8" pneumatisch
				01/02→ 01/09; + DSTC			03.7858-3532.4 300233	ATE Ø 9 / 8" pneumatisch
2.4	125	11/00→04/10		→ 12/01			03.7755-3402.4 300189	ATE Ø 9 / 8" pneumatisch
				01/02→ 01/09; - DSTC			03.7755-4702.4 300224	ATE Ø 9 / 8" pneumatisch
				01/02→ 01/09; + DSTC			03.7858-3532.4 300233	ATE Ø 9 / 8" pneumatisch
2.4	132	01/05→10/06		- DSTC			03.7755-4702.4 300224	ATE Ø 9 / 8" pneumatisch
2.4 CDI	85	10/03→12/05						
2.4 D	90	05/05→12/06		+ DSTC			03.7858-3532.4 300233	ATE Ø 9 / 8" pneumatisch
2.4 Bifuel	103	07/01→04/10		06/02→ 01/09; - DSTC			03.7755-4702.4 300224	ATE Ø 9 / 8" pneumatisch
				06/02→ 01/09; + DSTC			03.7858-3532.4 300233	ATE Ø 9 / 8" pneumatisch
2.4 D	93	03/05→04/10		09/05→ 01/09; - DSTC			03.7755-4702.4 300224	ATE Ø 9 / 8" pneumatisch
D5	136	03/05→04/10		09/05→ 01/09; + DSTC			03.7858-3532.4 300233	ATE Ø 9 / 8" pneumatisch
2.4 D	96	05/01→04/10		01/02→ 01/09; - DSTC			03.7755-4702.4 300224	ATE Ø 9 / 8" pneumatisch
				01/02→ 01/09; + DSTC			03.7858-3532.4 300233	ATE Ø 9 / 8" pneumatisch
2.4 T AWD	147	06/01→04/10		11/01→ 12/01			03.7755-3402.4 300189	ATE Ø 9 / 8" pneumatisch
				01/02→ 01/09; - DSTC			03.7755-4702.4 300224	ATE Ø 9 / 8" pneumatisch
				01/02→ 01/09; + DSTC			03.7858-3532.4 300233	ATE Ø 9 / 8" pneumatisch
2.5 T	154	01/03→04/10		02/04→ 01/09; - DSTC			03.7755-4702.4 300224	ATE Ø 9 / 8" pneumatisch
				02/04→ 01/09; + DSTC			03.7858-3532.4 300233	ATE Ø 9 / 8" pneumatisch
2.5 T AWD	154	07/02→04/10		04/04→ 01/09; - DSTC			03.7755-4702.4 300224	ATE Ø 9 / 8" pneumatisch
				04/04→ 01/09; + DSTC			03.7858-3532.4 300233	ATE Ø 9 / 8" pneumatisch
D5	120	01/01→04/10		07/01→ 12/01			03.7755-3402.4 300189	ATE Ø 9 / 8" pneumatisch
				01/02→ 01/09; - DSTC			03.7755-4702.4 300224	ATE Ø 9 / 8" pneumatisch
				01/02→ 01/09; + DSTC			03.7858-3532.4 300233	ATE Ø 9 / 8" pneumatisch
5 T AWD R 2	221	01/03→04/10		03/03→ 01/09; - DSTC			03.7755-4702.4 300224	ATE Ø 9 / 8" pneumatisch
	221	01/03→04/10		03/03→ 01/09; + DSTC			03.7858-3532.4 300233	ATE Ø 9 / 8" pneumatisch
T5	184	07/00→04/10		08/00→ 12/01			03.7755-3402.4 300189	ATE Ø 9 / 8" pneumatisch
				01/02→ 04/04; - DSTC			03.7755-4702.4 300224	ATE Ø 9 / 8" pneumatisch
				01/02→ 04/04; + DSTC			03.7858-3532.4 300233	ATE Ø 9 / 8" pneumatisch
T5 →	195	07/00→09/02		→ 12/01			03.7755-3402.4 300189	ATE Ø 9 / 8" pneumatisch





















	kw					! #		
VOLVO - S60 I (384) 07/00→04/10								
Bremskraftverstärker								
T5	195	07/00→09/02		- DSTC		03.7755-4702.4	300224	ATE Ø 9 / 8" pneumatisch
				+ DSTC		03.7858-3532.4	300233	ATE Ø 9 / 8" pneumatisch
T5	191	04/04→04/10		→ 01/09; - DSTC		03.7755-4702.4	300224	ATE Ø 9 / 8" pneumatisch
				→ 01/09; + DSTC		03.7858-3532.4	300233	ATE Ø 9 / 8" pneumatisch
Pedalwegsensor, Bremspedal								
2.0 T	132	07/00→04/10		09/01→ 12/01		03.0655-0004.2	370004	ATE
				01/05→ 01/09		03.0655-0005.2	370005	ATE
				01/02→ 01/09		03.0655-0005.2	370005	ATE
2.4	103	07/00→04/10		11/00→ 12/01		03.0655-0004.2	370004	ATE
2.4 T	147	07/00→04/10		01/05→ 01/09		03.0655-0005.2	370005	ATE
				01/02→ 01/09		03.0655-0005.2	370005	ATE
2.4	125	11/00→04/10		→ 12/01		03.0655-0004.2	370004	ATE
				01/05→ 01/09		03.0655-0005.2	370005	ATE
				01/02→ 01/09		03.0655-0005.2	370005	ATE
2.4	132	01/05→10/06				03.0655-0005.2	370005	ATE
2.4 CDI	85	10/03→12/05						
2.4 D	90	05/05→12/06						
2.4 Bifuel	103	07/01→04/10		01/05→ 01/09		03.0655-0005.2	370005	ATE
				06/02→ 01/09		03.0655-0005.2	370005	ATE
2.4 D	93	03/05→04/10		09/05→ 01/09		03.0655-0005.2	370005	ATE
D5	136	03/05→04/10						
2.4 D	96	05/01→04/10		01/05→ 01/09		03.0655-0005.2	370005	ATE
				01/02→ 01/09		03.0655-0005.2	370005	ATE
2.4 T AWD	147	06/01→04/10		11/01→ 12/01		03.0655-0004.2	370004	ATE
				01/05→ 01/09		03.0655-0005.2	370005	ATE
				01/02→ 01/09		03.0655-0005.2	370005	ATE
2.5 T	154	01/03→04/10		01/05→ 01/09		03.0655-0005.2	370005	ATE
				02/04→ 01/09		03.0655-0005.2	370005	ATE
2.5 T AWD	154	07/02→04/10		01/05→ 01/09		03.0655-0005.2	370005	ATE
				04/04→ 01/09		03.0655-0005.2	370005	ATE
D5	120	01/01→04/10		07/01→ 12/01		03.0655-0004.2	370004	ATE
				01/05→ 01/09		03.0655-0005.2	370005	ATE
				01/02→ 01/09		03.0655-0005.2	370005	ATE
5 T AWD	221	01/03→04/10		01/05→ 01/09		03.0655-0005.2	370005	ATE
R 2	221	01/03→04/10		03/03→ 01/09		03.0655-0005.2	370005	ATE
T5	184	07/00→04/10		08/00→ 12/01		03.0655-0004.2	370004	ATE
				01/02→ 04/04		03.0655-0005.2	370005	ATE
T5	195	07/00→09/02		→ 12/01		03.0655-0004.2	370004	ATE
						03.0655-0005.2	370005	ATE
T5	191	04/04→04/10		→ 01/09		03.0655-0005.2	370005	ATE
				01/05→ 01/09		03.0655-0005.2	370005	ATE
Hauptbremszylinder								
2.0 T	132	07/00→04/10		09/01→; → 8535; - DSTC		03.2125-7637.3	010707	ATE Ø 25,4
				09/01→; → 11551; für Rechtslenker; + DSTC		03.2125-7637.3	010707	ATE Ø 25,4
				11552→; → 01/09; für Rechtslenker; + DSTC		03.2125-7638.3	010738	ATE Ø 25,4
				8536→; → 01/09; für Rechtslenker; - DSTC		03.2125-7638.3	010738	ATE Ø 25,4
				09/01→; → 9499; für Linkslenker; + DSTC		03.2125-7708.3	010739	ATE Ø 25,4
				9500→; → 01/09; für Linkslenker; + DSTC		03.2125-7713.3	010819	ATE Ø 25,4
				8536→; → 01/09; für Linkslenker; - DSTC		03.2125-7743.3	010921	ATE Ø 25,4
2.4	103	07/00→04/10		11/00→; → 8535; - DSTC		03.2125-7637.3	010707	ATE Ø 25,4
2.4 T	147	07/00→04/10		11/00→; → 11551; für Rechtslenker; + DSTC		03.2125-7637.3	010707	ATE Ø 25,4
				11552→; → 01/09; für Rechtslenker; + DSTC		03.2125-7638.3	010738	ATE Ø 25,4
				8536→; → 01/09; für Rechtslenker; - DSTC		03.2125-7638.3	010738	ATE Ø 25,4
				11/00→; → 9499; für Linkslenker; + DSTC		03.2125-7708.3	010739	ATE Ø 25,4
→								













	kw			 	! #		
VOLVO - S60 I (384) 07/00→04/10							
 Hauptbremszylinder							
2.4 2.4 T	103 147	07/00→04/10 07/00→04/10	9500→; → 01/09; für Linkslenker; + DSTC	03.2125-7713.3	010819	ATE Ø 25,4	
			8536→; → 01/09; für Linkslenker; - DSTC	03.2125-7743.3	010921	ATE Ø 25,4	
2.4	125	11/00→04/10	→ 8535; - DSTC	03.2125-7637.3	010707	ATE Ø 25,4	
			→ 11551; für Rechtslenker; + DSTC	03.2125-7637.3	010707	ATE Ø 25,4	
			11552→; → 01/09; für Rechtslenker; + DSTC	03.2125-7638.3	010738	ATE Ø 25,4	
			8536→; → 01/09; für Rechtslenker; - DSTC	03.2125-7638.3	010738	ATE Ø 25,4	
			→ 9499; für Linkslenker; + DSTC	03.2125-7708.3	010739	ATE Ø 25,4	
			9500→; → 01/09; für Linkslenker; + DSTC	03.2125-7713.3	010819	ATE Ø 25,4	
			8536→; → 01/09; für Linkslenker; - DSTC	03.2125-7743.3	010921	ATE Ø 25,4	
2.4 2.4 CDI 2.4 D	132 85 90	01/05→10/06 10/03→12/05 05/05→12/06	für Linkslenker; + DSTC	03.2125-7713.3	010819	ATE Ø 25,4	
			für Linkslenker; - DSTC	03.2125-7743.3	010921	ATE Ø 25,4	
2.4 Bifuel	103	07/01→04/10	06/02→; → 11551; für Rechtslenker; + DSTC	03.2125-7637.3	010707	ATE Ø 25,4	
			06/02→ 01/09; für Rechtslenker; - DSTC	03.2125-7638.3	010738	ATE Ø 25,4	
			11552→; → 01/09; für Rechtslenker; + DSTC	03.2125-7638.3	010738	ATE Ø 25,4	
			06/02→; → 9499; für Linkslenker; + DSTC	03.2125-7708.3	010739	ATE Ø 25,4	
			9500→; → 01/09; für Linkslenker; + DSTC	03.2125-7713.3	010819	ATE Ø 25,4	
			06/02→ 01/09; für Linkslenker; - DSTC	03.2125-7743.3	010921	ATE Ø 25,4	
2.4 D D5	93 136	03/05→04/10 03/05→04/10	09/05→ 01/09; für Rechtslenker; + DSTC	03.2125-7638.3	010738	ATE Ø 25,4	
			09/05→; für Rechtslenker; → 01/09; - DSTC	03.2125-7638.3	010738	ATE Ø 25,4	
			09/05→ 01/09; für Linkslenker; + DSTC	03.2125-7713.3	010819	ATE Ø 25,4	
			09/05→ 01/09; für Linkslenker; - DSTC	03.2125-7743.3	010921	ATE Ø 25,4	
2.4 D	96	05/01→04/10	12/01→; → 8535; - DSTC	03.2125-7637.3	010707	ATE Ø 25,4	
			12/01→; → 11551; für Rechtslenker; + DSTC	03.2125-7637.3	010707	ATE Ø 25,4	
			11552→; → 01/09; für Rechtslenker; + DSTC	03.2125-7638.3	010738	ATE Ø 25,4	
			8536→; → 01/09; für Rechtslenker; - DSTC	03.2125-7638.3	010738	ATE Ø 25,4	
			12/01→; → 9499; für Linkslenker; + DSTC	03.2125-7708.3	010739	ATE Ø 25,4	
			9500→; → 01/09; für Linkslenker; + DSTC	03.2125-7713.3	010819	ATE Ø 25,4	
			8536→; → 01/09; für Linkslenker; - DSTC	03.2125-7743.3	010921	ATE Ø 25,4	
2.4 T AWD	147	06/01→04/10	11/01→; → 8535; - DSTC	03.2125-7637.3	010707	ATE Ø 25,4	
			11/01→; → 11551; für Rechtslenker; + DSTC	03.2125-7637.3	010707	ATE Ø 25,4	
			11552→; → 01/09; für Rechtslenker; + DSTC	03.2125-7638.3	010738	ATE Ø 25,4	
			8536→; → 01/09; für Rechtslenker; - DSTC	03.2125-7638.3	010738	ATE Ø 25,4	
			11/01→; → 9499; für Linkslenker; + DSTC	03.2125-7708.3	010739	ATE Ø 25,4	
			9500→; → 01/09; für Linkslenker; + DSTC	03.2125-7713.3	010819	ATE Ø 25,4	
			8536→; → 01/09; für Linkslenker; - DSTC	03.2125-7743.3	010921	ATE Ø 25,4	
2.5 T	154	01/03→04/10	02/04→; → 11551; für Rechtslenker; + DSTC	03.2125-7637.3	010707	ATE Ø 25,4	
			02/04→ 01/09; für Rechtslenker; - DSTC	03.2125-7638.3	010738	ATE Ø 25,4	
			11552→; → 01/09; für Rechtslenker; + DSTC	03.2125-7638.3	010738	ATE Ø 25,4	
			02/04→; → 9499; für Linkslenker; + DSTC	03.2125-7708.3	010739	ATE Ø 25,4	
			9500→; → 01/09; für Linkslenker; + DSTC	03.2125-7713.3	010819	ATE Ø 25,4	
			02/04→ 01/09; für Linkslenker; - DSTC	03.2125-7743.3	010921	ATE Ø 25,4	
2.5 T AWD	154	07/02→04/10	04/04→; → 11551; für Rechtslenker; + DSTC	03.2125-7637.3	010707	ATE Ø 25,4	
			04/04→ 01/09; für Rechtslenker; - DSTC	03.2125-7638.3	010738	ATE Ø 25,4	
→							











	kw			 	! #		
VOLVO - S60 I (384) 07/00→04/10							
 Hauptbremszylinder							
2.5 T AWD	154	07/02→04/10		11552→; → 01/09; für Rechtslenker; + DSTC	03.2125-7638.3	010738	ATE Ø 25,4
				04/04→; → 9499; für Linkslenker; + DSTC	03.2125-7708.3	010739	ATE Ø 25,4
				9500→; → 01/09; für Linkslenker; + DSTC	03.2125-7713.3	010819	ATE Ø 25,4
				04/04→ 01/09; für Linkslenker; - DSTC	03.2125-7743.3	010921	ATE Ø 25,4
D5	120	01/01→04/10		07/01→; → 8535; - DSTC	03.2125-7637.3	010707	ATE Ø 25,4
				07/01→; → 11551; für Rechtslenker; + DSTC	03.2125-7637.3	010707	ATE Ø 25,4
				11552→; → 01/09; für Rechtslenker; + DSTC	03.2125-7638.3	010738	ATE Ø 25,4
				8536→; → 01/09; für Rechtslenker; - DSTC	03.2125-7638.3	010738	ATE Ø 25,4
				07/01→; → 9499; für Linkslenker; + DSTC	03.2125-7708.3	010739	ATE Ø 25,4
				9500→; → 01/09; für Linkslenker; + DSTC	03.2125-7713.3	010819	ATE Ø 25,4
				8536→; → 01/09; für Linkslenker; - DSTC	03.2125-7743.3	010921	ATE Ø 25,4
5 T AWD R 2	221 221	01/03→04/10 01/03→04/10		03/03→; → 11551; für Rechtslenker; + DSTC	03.2125-7637.3	010707	ATE Ø 25,4
				03/03→ 01/09; für Rechtslenker; - DSTC	03.2125-7638.3	010738	ATE Ø 25,4
				11552→; → 01/09; für Rechtslenker; + DSTC	03.2125-7638.3	010738	ATE Ø 25,4
				03/03→; → 9499; für Linkslenker; + DSTC	03.2125-7708.3	010739	ATE Ø 25,4
				9500→; → 01/09; für Linkslenker; + DSTC	03.2125-7713.3	010819	ATE Ø 25,4
T5	184	07/00→04/10		03/03→ 01/09; für Linkslenker; - DSTC	03.2125-7743.3	010921	ATE Ø 25,4
				08/00→; → 8535; - DSTC	03.2125-7637.3	010707	ATE Ø 25,4
				08/00→; → 11551; für Rechtslenker; + DSTC	03.2125-7637.3	010707	ATE Ø 25,4
				11552→; → 04/04; für Rechtslenker; + DSTC	03.2125-7638.3	010738	ATE Ø 25,4
				8536→; → 04/04; für Rechtslenker; - DSTC	03.2125-7638.3	010738	ATE Ø 25,4
				08/00→; → 9499; für Linkslenker; + DSTC	03.2125-7708.3	010739	ATE Ø 25,4
T5	195	07/00→09/02		9500→; → 04/04; für Linkslenker; + DSTC	03.2125-7713.3	010819	ATE Ø 25,4
				8536→; → 04/04; für Linkslenker; - DSTC	03.2125-7743.3	010921	ATE Ø 25,4
				→ 8535; - DSTC	03.2125-7637.3	010707	ATE Ø 25,4
				→ 11551; für Rechtslenker; + DSTC	03.2125-7637.3	010707	ATE Ø 25,4
				8536→; für Rechtslenker; - DSTC	03.2125-7638.3	010738	ATE Ø 25,4
				11552→; für Rechtslenker; + DSTC	03.2125-7638.3	010738	ATE Ø 25,4
T5	191	04/04→04/10		→ 9499; für Linkslenker; + DSTC	03.2125-7708.3	010739	ATE Ø 25,4
				9500→; für Linkslenker; + DSTC	03.2125-7713.3	010819	ATE Ø 25,4
				8536→; für Linkslenker; - DSTC	03.2125-7743.3	010921	ATE Ø 25,4
				→ 11551; für Rechtslenker; + DSTC	03.2125-7637.3	010707	ATE Ø 25,4
				→ 01/09; für Rechtslenker; - DSTC	03.2125-7638.3	010738	ATE Ø 25,4
				11552→; → 01/09; für Rechtslenker; + DSTC	03.2125-7638.3	010738	ATE Ø 25,4
VOLVO - S60 II (134) 04/10→12/19							
 Bremskraftverstärker							
2.0 Polestar AWD	270	06/15→05/18		für Fahrzeuge ohne Kollisionswarner	03.7755-9703.4	300239	ATE Ø 9 / 8" pneumatisch
2.5 T	183	01/13→01/16					
D2	88	03/15→05/18					
D3	110	03/15→05/18					
D4	133 - 140	09/13→05/18					
D4 AWD	140	03/15→05/18					
D4 Drive-E Polestar	147	03/15→05/18					
D5	165	03/15→05/18					
D5 Drive-E Polestar	171	03/15→05/18					
→							









	kw			 	! #		
VOLVO - S60 II (134) 04/10→12/19							
 Bremskraftverstärker							
T5	186	09/11→12/15		für Fahrzeuge ohne Kollisionswarner	03.7755-9703.4	300239	ATE Ø 9 / 8" pneumatisch
T5 AWD	187	08/15→12/18					
2.0 T	132	05/12→12/15		12/13→; für Fahrzeuge ohne Kollisionswarner	03.7755-9703.4	300239	ATE Ø 9 / 8" pneumatisch
Pedalwegsensoren, Bremspedal							
2.0 T	132	05/12→12/15		12/13→; für Fahrzeuge mit Kollisionswarner	03.0655-0007.2	370007	ATE
2.0 T	149	04/10→12/11		für Fahrzeuge mit Kollisionswarner	03.0655-0007.2	370007	ATE
2.5 T	183	01/13→01/16					
D2	88	03/15→05/18					
D3	100 -	04/10→05/18					
	120						
D4	133 -	09/13→05/18					
	140						
D4 AWD	140	03/15→05/18					
D4 Drive-E Polestar	147	03/15→05/18					
D5	151 -	04/10→05/18					
	169						
D5 AWD	151 -	04/10→12/15					
	169						
D5 Drive-E Polestar	171	03/15→05/18					
DRIVE / D2	84	01/11→12/15					
T2	90	10/15→05/18					
T3	110 -	04/10→05/18					
	112						
T4	132	04/10→12/15					
T4F	132	04/11→12/15					
T5	177 -	04/10→12/18					
	186						
T5 AWD	180 -	09/12→12/18					
	187						
T5 DRIVE	180	09/14→12/15					
T6	225	09/13→12/18					
T6 AWD	224 -	04/10→12/18					
	242						
D4	120	04/10→12/14		05/12→; für Fahrzeuge mit Kollisionswarner	03.0655-0007.2	370007	ATE
D5	158	04/11→12/15		06/11→; für Fahrzeuge mit Kollisionswarner	03.0655-0007.2	370007	ATE
D5 AWD	158	04/11→12/15					
T4	140	03/15→05/18		05/15→; für Fahrzeuge mit Kollisionswarner	03.0655-0007.2	370007	ATE
 Hauptbremszylinder							
2.0 Polestar AWD	270	06/15→05/18		für Rechtslenker	24.4156-1391.3	011054	ATE Ø 27 ohne Bremsflüssigkeitsbehälter
2.0 T	132	05/12→12/15		12/13→	24.4156-1391.3	011054	ATE Ø 27 ohne Bremsflüssigkeitsbehälter
D5	165	03/15→05/18			24.4156-1391.3	011054	ATE Ø 27 ohne Bremsflüssigkeitsbehälter
D5 Drive-E Polestar	171	03/15→05/18					
T2	90	10/15→05/18					
T5	186	09/11→12/15					
T5 AWD	186	09/12→12/15					
T6 AWD	225	09/15→12/18					
VOLVO - S60 II Cross Country (134) 03/15→12/18							
 Bremskraftverstärker							
D4	140	03/15→05/18		für Fahrzeuge ohne Kollisionswarner	03.7755-9703.4	300239	ATE Ø 9 / 8" pneumatisch
D4 Polestar AWD	162	03/15→07/18					
T5 AWD	183	03/15→12/18					
D4 AWD	140	03/15→05/18		für Fahrzeuge ohne Kollisionswarner; Ausstattungs-Code: RC01	03.7755-0132.4	300265	ATE Ø 9 / 8" pneumatisch
D4 Drive-E Polestar	147	03/15→05/18					
T5 AWD	187	03/15→12/18		für Fahrzeuge ohne Kollisionswarner; Ausstattungs-Code: RC02	03.7755-9703.4	300239	ATE Ø 9 / 8" pneumatisch
Pedalwegsensoren, Bremspedal							
D4 Polestar AWD	162	03/15→07/18		für Fahrzeuge mit Kollisionswarner	03.0655-0007.2	370007	ATE
T5 AWD	183	03/15→12/18					
T5 Drive-E Polestar AWD	186	06/16→05/18					
VOLVO - S70 (874) 11/96→11/00							
 Hauptbremszylinder							
2.0	93 -	01/97→11/00		→ 12/98; - ASR	03.2023-1084.3	010591	ATE Ø1 23,8 Ø2 20,6
	132						
2.0 Turbo	155 -	01/97→11/00		01/99→	03.2123-2164.3	010599	ATE Ø 23,8
	166						
2.3 Turbo	184	01/97→11/00					
→							













	kw			 	! #		
VOLVO - S70 (874) 11/96→11/00							
 Hauptbremszylinder							
2.4	106 - 125	01/97→11/00		→ 12/98; - ASR		03.2023-1084.3 010591	ATE Ø1 23,8 Ø2 20,6
2.4 Bifuel	106	10/98→11/00		01/99→		03.2123-2164.3 010599	ATE Ø 23,8
2.4 Turbo	142	01/97→11/00					
2.5 TDI	103	01/97→11/00					
T5	176	01/97→11/00					
2.3	177	11/96→11/00		01/97→ 12/98; - ASR		03.2023-1084.3 010591	ATE Ø1 23,8 Ø2 20,6
				01/99→		03.2123-2164.3 010599	ATE Ø 23,8
2.3	195	04/99→09/00				03.2123-2164.3 010599	ATE Ø 23,8
2.4	103	08/99→11/00					
2.4 AWD	103	04/99→09/00					
2.4 Bifuel	103	07/99→11/00					
2.4 Blu-Fuel	103	07/97→09/00					
2.5 TDi AWD	103	10/99→09/00					
2.4 AWD	125	04/99→09/00		→ 05/99		03.2123-2164.3 010599	ATE Ø 23,8
VOLVO - S80 I (184) 05/98→02/08							
 Bremskraftverstärker							
2.0	120	06/98→07/06		→ 12/01; - DSTC		03.7755-3402.4 300189	ATE Ø 9 / 8" pneumatisch
2.0 T	132 - 166	06/98→07/06		01/02→ 02/06; - DSTC		03.7755-4702.4 300224	ATE Ø 9 / 8" pneumatisch
2.4	103 - 125	01/99→07/06		01/02→ 02/06; + DSTC		03.7858-3532.4 300233	ATE Ø 9 / 8" pneumatisch
2.4 Bifuel	103	09/01→07/06					
2.4 D	96	10/01→07/06					
2.4 T	147	06/00→07/06					
2.5 TDI	103	01/99→07/06					
2.9	147 - 150	05/98→07/06					
3.0	144	06/01→07/06					
D5	120	08/01→07/06					
T6	200	06/01→07/06					
2.3 R	195	04/00→08/05		→ 12/01; - DSTC		03.7755-3402.4 300189	ATE Ø 9 / 8" pneumatisch
				01/02→; - DSTC		03.7755-4702.4 300224	ATE Ø 9 / 8" pneumatisch
				01/02→; + DSTC		03.7858-3532.4 300233	ATE Ø 9 / 8" pneumatisch
2.5 T	154	03/03→07/06		07/03→ 02/06; - DSTC		03.7755-4702.4 300224	ATE Ø 9 / 8" pneumatisch
				07/03→ 02/06; + DSTC		03.7858-3532.4 300233	ATE Ø 9 / 8" pneumatisch
2.5 T AWD	154	07/03→07/06		→ 02/06; - DSTC		03.7755-4702.4 300224	ATE Ø 9 / 8" pneumatisch
				→ 02/06; + DSTC		03.7858-3532.4 300233	ATE Ø 9 / 8" pneumatisch
T5 AWD	147	04/00→09/03		06/00→ 12/01; - DSTC		03.7755-3402.4 300189	ATE Ø 9 / 8" pneumatisch
				01/02→; - DSTC		03.7755-4702.4 300224	ATE Ø 9 / 8" pneumatisch
				01/02→; + DSTC		03.7858-3532.4 300233	ATE Ø 9 / 8" pneumatisch
T6	200	05/98→12/01		- DSTC		03.7755-3402.4 300189	ATE Ø 9 / 8" pneumatisch
Pedalwegsensor, Bremspedal							
2.0	120	06/98→07/06		→ 12/01		03.0655-0004.2 370004	ATE
2.0 T	132 - 166	06/98→07/06		01/02→ 02/06		03.0655-0005.2 370005	ATE
2.4	103 - 125	01/99→07/06					
2.4 Bifuel	103	09/01→07/06					
2.4 D	96	10/01→07/06					
2.4 T	147	06/00→07/06					
2.5 TDI	103	01/99→07/06					
2.9	147 - 150	05/98→07/06					
3.0	144	06/01→07/06					
D5	120	08/01→07/06					
T6	200	06/01→07/06					
2.3 R	195	04/00→08/05		→ 12/01		03.0655-0004.2 370004	ATE
				01/02→		03.0655-0005.2 370005	ATE
2.5 T	154	03/03→07/06		07/03→ 02/06		03.0655-0005.2 370005	ATE
2.5 T AWD	154	07/03→07/06		→ 02/06		03.0655-0005.2 370005	ATE
T5 AWD	147	04/00→09/03		06/00→ 12/01		03.0655-0004.2 370004	ATE
				01/02→		03.0655-0005.2 370005	ATE
T6	200	05/98→12/01				03.0655-0004.2 370004	ATE
 Hauptbremszylinder							
2.0	120	06/98→07/06		→ 174095; - DSTC		03.2125-7637.3 010707	ATE Ø 25,4
2.0 T	166	06/98→07/06		→ 02/06; 174096→; für Rechtslenker		03.2125-7638.3 010738	ATE Ø 25,4
2.4	103 - 125	01/99→07/06		→ 174095; + DSTC		03.2125-7708.3 010739	ATE Ø 25,4
2.5 TDI	103	01/99→07/06					
→							







	kw			 	! #		
VOLVO - S80 I (184) 05/98→02/08							
 Hauptbremszylinder							
2.9	147 - 150	05/98→07/06		→ 02/06; 174096→; für Linkslenker; + DSTC		03.2125-7713.3 010819	ATE Ø 25,4
				→ 02/06; 174096→; für Linkslenker; - DSTC		03.2125-7743.3 010921	ATE Ø 25,4
2.0 T	132	12/99→07/06		→ 02/06; für Rechtslenker		03.2125-7638.3 010738	ATE Ø 25,4
2.4 Bifuel	103	09/01→07/06		→ 02/06; für Linkslenker; + DSTC		03.2125-7713.3 010819	ATE Ø 25,4
2.4 D	96	10/01→07/06					
2.4 T	147	06/00→07/06		→ 02/06; für Linkslenker; - DSTC		03.2125-7743.3 010921	ATE Ø 25,4
2.5 T AWD	154	07/03→07/06					
3.0	144	06/01→07/06					
D5	120	08/01→07/06					
T6	200	06/01→07/06					
2.3 R	195	04/00→08/05		→ 174095; - DSTC		03.2125-7637.3 010707	ATE Ø 25,4
T6	200	05/98→12/01		174096→; für Rechtslenker		03.2125-7638.3 010738	ATE Ø 25,4
				→ 174095; + DSTC		03.2125-7708.3 010739	ATE Ø 25,4
				174096→; für Linkslenker; + DSTC		03.2125-7713.3 010819	ATE Ø 25,4
				174096→; für Linkslenker; - DSTC		03.2125-7743.3 010921	ATE Ø 25,4
2.5 T	154	03/03→07/06		07/03→ 02/06; für Rechtslenker		03.2125-7638.3 010738	ATE Ø 25,4
				07/03→ 02/06; für Linkslenker; + DSTC		03.2125-7713.3 010819	ATE Ø 25,4
				07/03→ 02/06; für Linkslenker; - DSTC		03.2125-7743.3 010921	ATE Ø 25,4
T5 AWD	147	04/00→09/03		06/00→; für Rechtslenker		03.2125-7638.3 010738	ATE Ø 25,4
				06/00→; für Linkslenker; + DSTC		03.2125-7713.3 010819	ATE Ø 25,4
				06/00→; für Linkslenker; - DSTC		03.2125-7743.3 010921	ATE Ø 25,4
VOLVO - S80 II (124) 03/06→12/16							
 Bremskraftverstärker							
1.6 D DRIVe	80	01/10→12/11		für Linkslenker; für Fahrzeuge ohne Kollisionswarner		03.7755-9703.4 300239	ATE Ø 9 / 8" pneumatisch
1.6 DRIVe	84	06/11→01/14					
2.0	107	01/08→09/12					
2.0 Drive- E	180	12/14→12/16					
2.0 FlexFuel	107	01/08→12/11					
2.0 T	149	01/10→05/11					
2.0 TDi	100	02/08→03/11					
2.4 D	120 - 129	03/06→03/11					
2.5 T	147	03/06→12/11					
2.5 T FlexFuel	147	05/08→12/11					
3.2	175 - 179	03/06→12/14					
3.2 AWD	175 - 179	01/07→12/14					
3.2 Flexifuel AWD	177	01/09→03/10					
D2	85	01/14→12/16					
D3 / D4	120	01/10→12/16					
D5	136 - 151	03/06→12/11					
D5 AWD	136 - 151	01/07→12/11					
T5	162 - 180	10/10→12/16					
T6 AWD	210	01/07→12/10					
2.5 T	170 - 187	01/10→12/16		für Fahrzeuge ohne Kollisionswarner		03.7755-9703.4 300239	ATE Ø 9 / 8" pneumatisch
2.5 T FlexFuel	170	01/10→12/11					
D3	100	05/12→05/14					
D4	133	09/13→12/16					
D5	158	06/11→04/15					
D5 AWD	158	06/11→04/15					
T4	132	10/10→04/14					
T4F	132	05/11→01/14					
T6 AWD	224	10/10→12/15					
Pedalwegsensoren, Bremspedal							
1.6 D DRIVe	80	01/10→12/11		für Rechtslenker		03.0655-0007.2 370007	ATE
1.6 DRIVe	84	06/11→01/14					
D2	85	01/14→12/16		für Linkslenker; → 151000		03.0655-0007.2 370007	ATE
D3 / D4	120	01/10→12/16		151001→; für Linkslenker; für Fahrzeuge mit Kollisionswarner		03.0655-0007.2 370007	ATE
2.0	107	01/08→09/12		für Rechtslenker		03.0655-0007.2 370007	ATE
2.0 FlexFuel	107	01/08→12/11					
2.0 T	149	01/10→05/11		für Linkslenker; für Fahrzeuge mit Kollisionswarner		03.0655-0007.2 370007	ATE
2.0 TDi	100	02/08→03/11					
2.4 D	120 - 129	03/06→03/11					
2.5 T	147	03/06→12/11					
2.5 T FlexFuel	147	05/08→12/11					
→							









	kw			 	! #		
VOLVO - S80 II (124) 03/06→12/16							
Pedalwegsensoren, Bremspedal							
3.2	175 - 179	03/06→12/14		für Rechtslenker		03.0655-0007.2 370007	ATE
3.2 AWD	175 - 179	01/07→12/14		für Linkslenker; für Fahrzeuge mit Kollisionswarner		03.0655-0007.2 370007	ATE
3.2 Flexifuel AWD	177	01/09→03/10					
D5	136 - 151	03/06→12/11					
D5 AWD	136 - 151	01/07→12/11					
T6 AWD	210	01/07→12/10					
2.0 Drive- E	180	12/14→12/16		für Linkslenker; für Fahrzeuge mit Kollisionswarner		03.0655-0007.2 370007	ATE
2.5 T	170	01/10→12/12		→ 151000		03.0655-0007.2 370007	ATE
2.5 T FlexFuel	170	01/10→12/11					
D3	100	05/12→05/14		151001→; für Fahrzeuge mit Kollisionswarner		03.0655-0007.2 370007	ATE
D5	158	06/11→04/15					
D5 AWD	158	06/11→04/15					
T4	132	10/10→04/14					
T4F	132	05/11→01/14					
T6 AWD	224	10/10→12/15					
2.5 T	183 - 187	01/12→12/16		für Fahrzeuge mit Kollisionswarner		03.0655-0007.2 370007	ATE
D4	133	09/13→12/16					
T5	162 - 180	10/10→12/16					
 Hauptbremszylinder							
T5	162	01/14→12/16				24.4156-1391.3 011054	ATE Ø 27 ohne Bremsflüssigkeitsbehälter
VOLVO - V40 Cross Country (526) 09/13→12/15							
 Hauptbremszylinder							
1.6 D2/ DRIVe	84	09/13→12/15		für Fahrzeuge ohne Kollisionswarner		03.2125-5016.3 011010	ATE Ø 25,4
VOLVO - V40 Cross Country (526) 10/12→08/19							
 Hauptbremszylinder							
D2	84 - 88	10/12→08/19		Ausstattungs-Code: KI01		03.2125-5016.3 011010	ATE Ø 25,4
D3	110	04/15→08/19					
T3	112	02/15→08/19		für Fahrzeuge ohne Kollisionswarner		03.2125-5016.3 011010	ATE Ø 25,4
T4	140	08/15→08/19					
T4 GTDi	132	10/12→12/16				03.2125-5016.3 011010	ATE Ø 25,4
VOLVO - V40 Kasten/Schrägheck (525) 09/13→12/15							
 Hauptbremszylinder							
1.6 D2/ DRIVe	84	09/13→12/15		für Fahrzeuge ohne Kollisionswarner		03.2125-5016.3 011010	ATE Ø 25,4
2.0 D3	110	09/13→12/15					
2.0 D4	130	09/13→12/14					
VOLVO - V40 Kombi (645) 07/95→06/04							
 Hauptbremszylinder							
1.6	80	03/99→06/04				24.2123-1746.3 010682	Ø 23,8
1.8	90	03/99→06/04					
1.8 Bi-Fuel	88	11/99→08/03					
1.8 Blu-Fuel	85	06/01→08/03					
1.8 i	90 - 92	03/98→06/04					
1.8 LPG	90	03/99→06/04					
1.9	127	09/03→06/04					
1.9 DI	70 - 85	03/99→06/04					
2.0 T	118 - 120	10/97→06/04					
1.9 T4	147	05/97→07/00		→ 08/97; + ABS		24.2122-1718.3 010517	Ø 22,2
				09/97→		24.2123-1746.3 010682	Ø 23,8
2.0	100	07/95→06/04		→ 08/97		24.2122-1718.3 010517	Ø 22,2
				09/97→		24.2123-1746.3 010682	Ø 23,8
2.0 T	121	07/99→06/04		07/00→ 06/01		24.2123-1746.3 010682	Ø 23,8
2.0 T4	147	07/00→06/04		→ 04/04		24.2123-1746.3 010682	Ø 23,8

	kw			 	! #		
VOLVO - V40 Schrägheck (525) 03/12→08/19							
 Hauptbremszylinder							
D2 D3 D4 T3 GTDi T4 GTDi	84 110 130 110 132	03/12→12/16 03/12→03/15 03/12→12/14 03/12→12/16 03/12→12/16		09/12→; für Fahrzeuge ohne Kollisionswarner		03.2125-5016.3 011010	ATE Ø 25,4
D3 T4	110 132 - 147	04/15→08/19 07/13→12/15		für Fahrzeuge ohne Kollisionswarner		03.2125-5016.3 011010	ATE Ø 25,4
VOLVO - V50 (545) 12/03→12/12							
 Bremskraftverstärker							
1.6 1.6 D 2.0 2.0 FlexFuel T5	74 80 107 107 169	01/05→12/12 03/05→12/12 10/06→12/12 01/10→12/12 03/07→12/12		→ 05/12; für Linkslenker		03.7863-4832.4 300289	ATE Ø 10" pneumatisch
1.6 D 1.8 1.8 BiFuel 1.8 FlexFuel 2.0 CDI 2.0 D 2.0 D4 2.4 2.4 AWD 2.4 Tdi D5 T5 T5 AWD	81 92 93 92 98 100 96 103 - 125 125 120 132 162 162 - 169	01/05→12/11 04/04→12/10 01/09→09/10 01/05→12/10 12/03→12/06 04/04→12/10 07/05→12/06 04/04→12/10 08/06→12/09 05/07→12/10 03/06→12/10 04/04→12/07 04/04→12/10		für Linkslenker		03.7863-4832.4 300289	ATE Ø 10" pneumatisch
Pedalwegsensoren, Bremspedal							
1.6 1.6 D 2.0 2.0 FlexFuel T5	74 80 107 107 169	01/05→12/12 03/05→12/12 10/06→12/12 01/10→12/12 03/07→12/12		→ 05/12		03.0655-0007.2 370007	ATE
1.6 D 1.8 1.8 BiFuel 1.8 FlexFuel 2.0 CDI 2.0 D 2.0 D4 2.4 2.4 AWD 2.4 Tdi D5 T5 T5 AWD	81 92 93 92 98 100 96 103 - 125 125 120 132 162 162 - 169	01/05→12/11 04/04→12/10 01/09→09/10 01/05→12/10 12/03→12/06 04/04→12/10 07/05→12/06 04/04→12/10 08/06→12/09 05/07→12/10 03/06→12/10 04/04→12/07 04/04→12/10				03.0655-0007.2 370007	ATE
 Hauptbremszylinder							
1.6 1.6 D 2.0 2.0 FlexFuel T5	74 80 107 107 169	01/05→12/12 03/05→12/12 10/06→12/12 01/10→12/12 03/07→12/12		→ 05/12; für Linkslenker		03.2123-3593.3 010919	ATE Ø 23,8
1.6 D 1.8 1.8 BiFuel 1.8 FlexFuel 2.0 CDI 2.0 D 2.0 D4 2.4 2.4 AWD 2.4 Tdi D5 T5 T5 AWD	81 92 93 92 98 100 96 103 - 125 125 120 132 162 162 - 169	01/05→12/11 04/04→12/10 01/09→09/10 01/05→12/10 12/03→12/06 04/04→12/10 07/05→12/06 04/04→12/10 08/06→12/09 05/07→12/10 03/06→12/10 04/04→12/07 04/04→12/10		für Linkslenker		03.2123-3593.3 010919	ATE Ø 23,8
D2 D3 D4	84 110 130	01/10→12/12 10/10→12/12 10/10→12/12		→ 05/12; für Linkslenker		03.2123-3624.3 010956	ATE Ø 23,8









	kw			 	! #		
VOLVO - V60 I (155) 07/10→12/18							
 Bremskraftverstärker							
2.0 BiFuel 2.0 Polestar AWD 2.0 T D2 D3 D4 D4 AWD D5 D6 Hybrid AWD T5 T6 T6 AWD 3.0 T AWD	157 270 132 88 110 133 - 140 133 - 140 165 206 162 224 242 258	03/14→12/15 06/15→05/18 01/14→07/18 03/15→05/18 03/15→05/18 10/13→05/18 10/13→05/18 03/15→05/18 03/15→05/18 01/14→12/17 07/14→04/15 04/14→12/15 04/14→05/18		für Fahrzeuge ohne Kollisionswarner		03.7755-9703.4 300239	ATE Ø 9 / 8" pneumatisch
D4 AWD	120	05/12→12/15		12/12→; für Fahrzeuge ohne Kollisionswarner		03.7755-9703.4 300239	ATE Ø 9 / 8" pneumatisch
T5	157	10/13→05/18		04/14→; für Fahrzeuge ohne Kollisionswarner		03.7755-9703.4 300239	ATE Ø 9 / 8" pneumatisch
T5 AWD	180 - 187	07/14→05/18		für Fahrzeuge ohne Kollisionswarner; Ausstattungs-Code: RC01		03.7755-0132.4 300265	ATE Ø 9 / 8" pneumatisch
				für Fahrzeuge ohne Kollisionswarner; Ausstattungs-Code: RC02		03.7755-9703.4 300239	ATE Ø 9 / 8" pneumatisch
Pedalwegsensord, Bremspedal							
1.6 DRIVe D5 D5 AWD	84 158 158	02/11→12/15 04/11→12/15 04/11→12/15		06/11→; für Fahrzeuge mit Kollisionswarner		03.0655-0007.2 370007	ATE
2.0 T D3 / D4 D5 D5 AWD T3 T4 T5 T6 AWD	149 120 151 151 110 132 177 224	07/10→12/12 07/10→12/14 07/10→12/11 07/10→12/11 09/10→12/15 09/10→12/15 09/10→12/14 07/10→12/15		11/10→; für Fahrzeuge mit Kollisionswarner		03.0655-0007.2 370007	ATE
D2 D3 D4 D4 AWD D5 D5 AWD D5 Hybrid AWD D6 Hybrid AWD T3 T4F T5 T6 T6 AWD	88 110 133 - 140 133 - 140 165 - 169 169 169 206 112 132 176 - 180 224 - 225 225 - 242	03/15→05/18 03/15→05/18 10/13→05/18 10/13→05/18 04/14→05/18 04/14→12/15 03/15→05/18 03/15→05/18 03/15→05/18 04/11→12/15 08/12→12/18 10/13→12/18 10/13→12/18		für Fahrzeuge mit Kollisionswarner		03.0655-0007.2 370007	ATE
D3	100	05/12→12/15		10/12→; für Fahrzeuge mit Kollisionswarner		03.0655-0007.2 370007	ATE
D4 AWD	120	05/12→12/15		12/12→; für Fahrzeuge mit Kollisionswarner		03.0655-0007.2 370007	ATE
D6 Hybrid AWD	206	06/12→12/15		11/12→; für Fahrzeuge mit Kollisionswarner		03.0655-0007.2 370007	ATE
T2	90	10/15→03/17		01/16→; für Fahrzeuge mit Kollisionswarner		03.0655-0007.2 370007	ATE
T4	140	03/15→05/18		05/15→; für Fahrzeuge mit Kollisionswarner		03.0655-0007.2 370007	ATE
T5	157	10/13→05/18		04/14→; für Fahrzeuge mit Kollisionswarner		03.0655-0007.2 370007	ATE
 Hauptbremszylinder							
2.0 BiFuel 2.0 T D2 D5 Hybrid AWD D6 Hybrid AWD T5 2.0 Polestar AWD	157 132 88 169 206 162 270	03/14→12/15 01/14→07/18 03/15→05/18 03/15→05/18 03/15→05/18 01/14→12/17 06/15→05/18		für Rechtslenker		24.4156-1391.3 011054	ATE Ø 27 ohne Bremsflüssigkeitsbehälter
→							

	kw					! #		
VOLVO - V60 I (155) 07/10→12/18								
 Hauptbremszylinder								
T2	90	10/15→03/17		01/16→			24.4156-1391.3 011054	ATE Ø 27 ohne Bremsflüssigkeitsbehälter
VOLVO - V60 I Cross Country (157) 09/10→12/18								
 Bremskraftverstärker								
D2	88	03/15→05/18		für Fahrzeuge ohne Kollisionswarner;			03.7755-0132.4 300265	ATE Ø 9 / 8" pneumatisch
D3	110	03/15→05/18		Ausstattungs-Code: RC01				
D4	140	03/15→05/18		für Fahrzeuge ohne Kollisionswarner;			03.7755-9703.4 300239	ATE Ø 9 / 8" pneumatisch
D4 AWD	140	03/15→05/18		Ausstattungs-Code: RC02				
D5	165	03/15→05/18						
D5 Hybrid AWD	169	03/15→05/18						
T5	180	03/15→05/18						
T5 AWD	180 - 187	03/15→05/18						
T5 Drive-E Polestar	186	03/15→07/18						
T5 Drive-E Polestar AWD	186	03/15→07/18						
D4 Polestar AWD	147 - 162	03/15→05/18		für Fahrzeuge ohne Kollisionswarner			03.7755-9703.4 300239	ATE Ø 9 / 8" pneumatisch
Pedalwegsensord, Bremspedal								
D4 Drive-E Polestar	147	03/15→05/18		05/15→; für Fahrzeuge mit Kollisionswarner			03.0655-0007.2 370007	ATE
D4 Polestar AWD	147 - 162	03/15→05/18		für Fahrzeuge mit Kollisionswarner			03.0655-0007.2 370007	ATE
VOLVO - V60 I Kasten/Kombi (155) 09/13→12/15								
 Bremskraftverstärker								
2.4 D4 AWD	133	09/13→12/15		für Fahrzeuge ohne Kollisionswarner			03.7755-9703.4 300239	ATE Ø 9 / 8" pneumatisch
Pedalwegsensord, Bremspedal								
1.6 DRiVe	84	09/13→12/15		für Fahrzeuge mit Kollisionswarner			03.0655-0007.2 370007	ATE
2.0 D3	100	09/13→12/15						
2.0 D4	120	09/13→12/15						
2.4 D4 AWD	133	09/13→12/15						
2.4 D5	158	09/13→12/15						
VOLVO - V70 I (875, 876) 12/95→12/00								
 Hauptbremszylinder								
2.0	93 - 132	12/95→03/00		01/97→ 12/98; - ASR			03.2023-1084.3 010591	ATE Ø1 23,8 Ø2 20,6
2.0 Turbo	155	12/95→03/00		01/99→			03.2123-2164.3 010599	ATE Ø 23,8
2.3 Turbo	184	12/95→03/00						
2.4	106	12/95→03/00						
2.5 TDi AWD	103	11/96→02/00						
2.0	120	01/97→12/00		→ 12/98; - ASR			03.2023-1084.3 010591	ATE Ø1 23,8 Ø2 20,6
2.3 T-5 AWD	176	01/97→12/00		01/99→ 03/00			03.2123-2164.3 010599	ATE Ø 23,8
2.0 Turbo	166	11/96→12/00		01/97→ 12/98; - ASR			03.2023-1084.3 010591	ATE Ø1 23,8 Ø2 20,6
2.0 Turbo AWD	166	11/96→12/00		01/99→ 03/00			03.2123-2164.3 010599	ATE Ø 23,8
2.3	177	11/96→11/00						
2.3 T-5	176	11/96→12/00						
2.4	125	12/95→05/00						
2.4 Turbo	142	04/96→12/00						
2.4 Turbo AWD	142	04/96→12/00						
2.5 TDI	103	12/95→12/00						
2.3 AWD	195	12/98→02/00		01/99→ 05/99			03.2123-2164.3 010599	ATE Ø 23,8
2.3 T AWD	184	04/97→03/00		→ 12/98; - ASR			03.2023-1084.3 010591	ATE Ø1 23,8 Ø2 20,6
				01/99→			03.2123-2164.3 010599	ATE Ø 23,8
2.4	103	03/99→12/00		08/99→ 03/00			03.2123-2164.3 010599	ATE Ø 23,8
2.4 Bifuel	103	08/99→12/00		→ 03/00			03.2123-2164.3 010599	ATE Ø 23,8
2.4 Turbo AWD	195	03/99→12/00						
VOLVO - V70 II (285) 11/99→12/08								
 Bremskraftverstärker								
2.0 T	132	11/99→08/07		07/01→ 12/01; - DSTC			03.7755-3402.4 300189	ATE Ø 9 / 8" pneumatisch
				01/02→ 07/07; - DSTC			03.7755-4702.4 300224	ATE Ø 9 / 8" pneumatisch
				01/02→ 07/07; + DSTC			03.7858-3532.4 300233	ATE Ø 9 / 8" pneumatisch
2.3	195	10/00→09/04		→ 12/01; - DSTC			03.7755-3402.4 300189	ATE Ø 9 / 8" pneumatisch
				- DSTC			03.7755-4702.4 300224	ATE Ø 9 / 8" pneumatisch
				+ DSTC			03.7858-3532.4 300233	ATE Ø 9 / 8" pneumatisch
2.4	103 - 125	03/00→08/07		→ 12/01; - DSTC			03.7755-3402.4 300189	ATE Ø 9 / 8" pneumatisch
→								

	kw			 	! #		
VOLVO - V70 II (285) 11/99→12/08							
Bremskraftverstärker							
2.4 Bifuel	103	09/01→08/07		01/02→ 07/07; - DSTC		03.7755-4702.4 300224	ATE Ø 9 / 8" pneumatisch
				01/02→ 07/07; + DSTC		03.7858-3532.4 300233	ATE Ø 9 / 8" pneumatisch
2.4 CDI 2.5 AWD	90 155	07/05→12/08 09/02→12/04		- DSTC		03.7755-4702.4 300224	ATE Ø 9 / 8" pneumatisch
				+ DSTC		03.7858-3532.4 300233	ATE Ø 9 / 8" pneumatisch
2.4 D	93	04/05→12/08		05/05→ 07/07; - DSTC		03.7755-4702.4 300224	ATE Ø 9 / 8" pneumatisch
				05/05→ 07/07; + DSTC		03.7858-3532.4 300233	ATE Ø 9 / 8" pneumatisch
2.4 D	96	07/01→08/07		12/01→ 12/01; - DSTC		03.7755-3402.4 300189	ATE Ø 9 / 8" pneumatisch
				01/02→ 07/07; - DSTC		03.7755-4702.4 300224	ATE Ø 9 / 8" pneumatisch
				01/02→ 07/07; + DSTC		03.7858-3532.4 300233	ATE Ø 9 / 8" pneumatisch
2.4 T T5	147 184	11/99→08/03 11/99→12/04		03/00→ 12/01; - DSTC		03.7755-3402.4 300189	ATE Ø 9 / 8" pneumatisch
				01/02→; - DSTC		03.7755-4702.4 300224	ATE Ø 9 / 8" pneumatisch
				01/02→; + DSTC		03.7858-3532.4 300233	ATE Ø 9 / 8" pneumatisch
2.4 T AWD	147	09/01→08/02		→ 12/01; - DSTC		03.7755-3402.4 300189	ATE Ø 9 / 8" pneumatisch
				01/02→; - DSTC		03.7755-4702.4 300224	ATE Ø 9 / 8" pneumatisch
				01/02→; + DSTC		03.7858-3532.4 300233	ATE Ø 9 / 8" pneumatisch
2.5 T	154	07/01→08/07		04/04→ 07/07; - DSTC		03.7755-4702.4 300224	ATE Ø 9 / 8" pneumatisch
				04/04→ 07/07; + DSTC		03.7858-3532.4 300233	ATE Ø 9 / 8" pneumatisch
2.5 T AWD	154	07/02→08/07		09/02→ 07/07; - DSTC		03.7755-4702.4 300224	ATE Ø 9 / 8" pneumatisch
				09/02→ 07/07; + DSTC		03.7858-3532.4 300233	ATE Ø 9 / 8" pneumatisch
2.5 TDI	103	11/99→08/07		03/00→ 12/01; - DSTC		03.7755-3402.4 300189	ATE Ø 9 / 8" pneumatisch
				01/02→ 07/07; - DSTC		03.7755-4702.4 300224	ATE Ø 9 / 8" pneumatisch
				01/02→ 07/07; + DSTC		03.7858-3532.4 300233	ATE Ø 9 / 8" pneumatisch
D5	120	01/01→12/08		08/01→ 12/01; - DSTC		03.7755-3402.4 300189	ATE Ø 9 / 8" pneumatisch
				01/02→ 07/07; - DSTC		03.7755-4702.4 300224	ATE Ø 9 / 8" pneumatisch
				01/02→ 07/07; + DSTC		03.7858-3532.4 300233	ATE Ø 9 / 8" pneumatisch
D5 D5 AWD	136 136	04/05→12/08 05/05→08/07		12/05→ 07/07; - DSTC		03.7755-4702.4 300224	ATE Ø 9 / 8" pneumatisch
				12/05→ 07/07; + DSTC		03.7858-3532.4 300233	ATE Ø 9 / 8" pneumatisch
D5 AWD	120	07/02→08/07		03/03→ 07/07; - DSTC		03.7755-4702.4 300224	ATE Ø 9 / 8" pneumatisch
				03/03→ 07/07; + DSTC		03.7858-3532.4 300233	ATE Ø 9 / 8" pneumatisch
5 T AWD R 2 T5	221 221 191	03/03→08/07 03/03→08/07 04/04→08/07		→ 07/07; - DSTC		03.7755-4702.4 300224	ATE Ø 9 / 8" pneumatisch
				→ 07/07; + DSTC		03.7858-3532.4 300233	ATE Ø 9 / 8" pneumatisch
Pedalwegsensoren, Bremspedal							
2.0 T	132	11/99→08/07		07/01→ 12/01		03.0655-0004.2 370004	ATE
				01/05→ 07/07		03.0655-0005.2 370005	ATE
				01/02→ 07/07		03.0655-0005.2 370005	ATE
2.3	195	10/00→09/04		→ 12/01		03.0655-0004.2 370004	ATE
						03.0655-0005.2 370005	ATE
2.4	103 - 125	03/00→08/07		→ 12/01		03.0655-0004.2 370004	ATE
2.4 Bifuel	103	09/01→08/07		01/05→ 07/07		03.0655-0005.2 370005	ATE
				01/02→ 07/07		03.0655-0005.2 370005	ATE
2.4 CDI 2.5 AWD	90 155	07/05→12/08 09/02→12/04				03.0655-0005.2 370005	ATE
2.4 D	93	04/05→12/08		05/05→ 07/07		03.0655-0005.2 370005	ATE
2.4 D	96	07/01→08/07		12/01→ 12/01		03.0655-0004.2 370004	ATE
				01/05→ 07/07		03.0655-0005.2 370005	ATE
				01/02→ 07/07		03.0655-0005.2 370005	ATE
2.4 T T5	147 184	11/99→08/03 11/99→12/04		03/00→ 12/01		03.0655-0004.2 370004	ATE
				01/02→		03.0655-0005.2 370005	ATE
2.4 T AWD	147	09/01→08/02		→ 12/01		03.0655-0004.2 370004	ATE
				01/02→		03.0655-0005.2 370005	ATE
2.5 T	154	07/01→08/07		01/05→ 07/07		03.0655-0005.2 370005	ATE
				04/04→ 07/07		03.0655-0005.2 370005	ATE
2.5 T AWD	154	07/02→08/07		01/05→ 07/07		03.0655-0005.2 370005	ATE
				09/02→ 07/07		03.0655-0005.2 370005	ATE
2.5 TDI	103	11/99→08/07		03/00→ 12/01		03.0655-0004.2 370004	ATE
				01/05→ 07/07		03.0655-0005.2 370005	ATE
				01/02→ 07/07		03.0655-0005.2 370005	ATE
D5	120	01/01→12/08		08/01→ 12/01		03.0655-0004.2 370004	ATE
				01/05→ 07/07		03.0655-0005.2 370005	ATE
→							







	kw			 	! #		
VOLVO - V70 II (285) 11/99→12/08							
Pedalwegsensord, Bremspedal							
D5	120	01/01→12/08		01/02→ 07/07		03.0655-0005.2 370005	ATE
D5	136	04/05→12/08		12/05→ 07/07		03.0655-0005.2 370005	ATE
D5 AWD	136	05/05→08/07					
D5 AWD	120	07/02→08/07		01/05→ 07/07		03.0655-0005.2 370005	ATE
				03/03→ 07/07		03.0655-0005.2 370005	ATE
5 T AWD	221	03/03→08/07		→ 07/07		03.0655-0005.2 370005	ATE
R 2	221	03/03→08/07					
T5	191	04/04→08/07		01/05→ 07/07		03.0655-0005.2 370005	ATE
 Hauptbremszylinder							
2.0 T	132	11/99→08/07		07/01→; → 68132; - DSTC		03.2125-7637.3 010707	ATE Ø 25,4
				07/01→; → 67770; für Rechtslenker; + DSTC		03.2125-7637.3 010707	ATE Ø 25,4
				68133→; → 07/07; für Rechtslenker; - DSTC		03.2125-7638.3 010738	ATE Ø 25,4
				67771→; → 07/07; für Rechtslenker; + DSTC		03.2125-7638.3 010738	ATE Ø 25,4
				07/01→; → 70377; für Linkslenker; + DSTC		03.2125-7708.3 010739	ATE Ø 25,4
				70378→; → 07/07; für Linkslenker; + DSTC		03.2125-7713.3 010819	ATE Ø 25,4
				68133→; → 07/07; für Linkslenker; - DSTC		03.2125-7743.3 010921	ATE Ø 25,4
2.3	195	10/00→09/04		→ 68132; - DSTC		03.2125-7637.3 010707	ATE Ø 25,4
2.4 CDI	90	07/05→12/08					
2.4 T AWD	147	09/01→08/02		→ 67770; für Rechtslenker; + DSTC		03.2125-7637.3 010707	ATE Ø 25,4
				67771→; für Rechtslenker; + DSTC		03.2125-7638.3 010738	ATE Ø 25,4
				68133→; für Rechtslenker; - DSTC		03.2125-7638.3 010738	ATE Ø 25,4
				→ 70377; für Linkslenker; + DSTC		03.2125-7708.3 010739	ATE Ø 25,4
				70378→; für Linkslenker; + DSTC		03.2125-7713.3 010819	ATE Ø 25,4
				68133→; für Linkslenker; - DSTC		03.2125-7743.3 010921	ATE Ø 25,4
2.4	103 - 125	03/00→08/07		→ 68132; - DSTC		03.2125-7637.3 010707	ATE Ø 25,4
2.4 Bifuel	103	09/01→08/07		→ 67770; für Rechtslenker; + DSTC		03.2125-7637.3 010707	ATE Ø 25,4
				68133→; → 07/07; für Rechtslenker; - DSTC		03.2125-7638.3 010738	ATE Ø 25,4
				67771→; → 07/07; für Rechtslenker; + DSTC		03.2125-7638.3 010738	ATE Ø 25,4
				→ 70377; für Linkslenker; + DSTC		03.2125-7708.3 010739	ATE Ø 25,4
				70378→; → 07/07; für Linkslenker; + DSTC		03.2125-7713.3 010819	ATE Ø 25,4
				68133→; → 07/07; für Linkslenker; - DSTC		03.2125-7743.3 010921	ATE Ø 25,4
2.4 D	93	04/05→12/08		05/05→ 07/07; für Rechtslenker		03.2125-7638.3 010738	ATE Ø 25,4
				05/05→ 07/07; für Linkslenker; + DSTC		03.2125-7713.3 010819	ATE Ø 25,4
				05/05→ 07/07; für Linkslenker; - DSTC		03.2125-7743.3 010921	ATE Ø 25,4
2.4 D	96	07/01→08/07		12/01→; → 68132; - DSTC		03.2125-7637.3 010707	ATE Ø 25,4
				12/01→; → 67770; für Rechtslenker; + DSTC		03.2125-7637.3 010707	ATE Ø 25,4
				68133→; → 07/07; für Rechtslenker; - DSTC		03.2125-7638.3 010738	ATE Ø 25,4
				67771→; → 07/07; für Rechtslenker; + DSTC		03.2125-7638.3 010738	ATE Ø 25,4
				12/01→; → 70377; für Linkslenker; + DSTC		03.2125-7708.3 010739	ATE Ø 25,4
				70378→; → 07/07; für Linkslenker; + DSTC		03.2125-7713.3 010819	ATE Ø 25,4
				68133→; → 07/07; für Linkslenker; - DSTC		03.2125-7743.3 010921	ATE Ø 25,4
2.4 T	147	11/99→08/03		03/00→; → 67770; für Rechtslenker; + DSTC		03.2125-7637.3 010707	ATE Ø 25,4
T5	184	11/99→12/04					
				03/00→; → 68132; - DSTC		03.2125-7637.3 010707	ATE Ø 25,4
				68133→; für Rechtslenker; - DSTC		03.2125-7638.3 010738	ATE Ø 25,4
				67771→; für Rechtslenker; + DSTC		03.2125-7638.3 010738	ATE Ø 25,4
				03/00→; → 70377; für Linkslenker; + DSTC		03.2125-7708.3 010739	ATE Ø 25,4
				70378→; für Linkslenker; + DSTC		03.2125-7713.3 010819	ATE Ø 25,4
				68133→; für Linkslenker; - DSTC		03.2125-7743.3 010921	ATE Ø 25,4
2.5 AWD	155	09/02→12/04		für Rechtslenker		03.2125-7638.3 010738	ATE Ø 25,4
				für Linkslenker; + DSTC		03.2125-7713.3 010819	ATE Ø 25,4
				für Linkslenker; - DSTC		03.2125-7743.3 010921	ATE Ø 25,4
→							





















	kw			 	! #		
VOLVO - V70 II (285) 11/99→12/08							
 Hauptbremszylinder							
2.5 T	154	07/01→08/07		04/04→ 07/07; für Rechtslenker	03.2125-7638.3	010738	ATE Ø 25,4
				04/04→ 07/07; für Linkslenker; + DSTC	03.2125-7713.3	010819	ATE Ø 25,4
				04/04→ 07/07; für Linkslenker; - DSTC	03.2125-7743.3	010921	ATE Ø 25,4
2.5 T AWD	154	07/02→08/07		09/02→ 07/07; für Rechtslenker	03.2125-7638.3	010738	ATE Ø 25,4
				09/02→ 07/07; für Linkslenker; + DSTC	03.2125-7713.3	010819	ATE Ø 25,4
				09/02→ 07/07; für Linkslenker; - DSTC	03.2125-7743.3	010921	ATE Ø 25,4
2.5 TDI	103	11/99→08/07		03/00→; → 68132; - DSTC	03.2125-7637.3	010707	ATE Ø 25,4
				03/00→; → 67770; für Rechtslenker; + DSTC	03.2125-7637.3	010707	ATE Ø 25,4
				68133→; → 07/07; für Rechtslenker; - DSTC	03.2125-7638.3	010738	ATE Ø 25,4
				67771→; → 07/07; für Rechtslenker; + DSTC	03.2125-7638.3	010738	ATE Ø 25,4
				03/00→; → 70377; für Linkslenker; + DSTC	03.2125-7708.3	010739	ATE Ø 25,4
				70378→; → 07/07; für Linkslenker; + DSTC	03.2125-7713.3	010819	ATE Ø 25,4
				68133→; → 07/07; für Linkslenker; - DSTC	03.2125-7743.3	010921	ATE Ø 25,4
D5	120	01/01→12/08		08/01→; → 68132; - DSTC	03.2125-7637.3	010707	ATE Ø 25,4
				08/01→; → 67770; für Rechtslenker; + DSTC	03.2125-7637.3	010707	ATE Ø 25,4
				68133→; → 07/07; für Rechtslenker; - DSTC	03.2125-7638.3	010738	ATE Ø 25,4
				67771→; → 07/07; für Rechtslenker; + DSTC	03.2125-7638.3	010738	ATE Ø 25,4
				08/01→; → 70377; für Linkslenker; + DSTC	03.2125-7708.3	010739	ATE Ø 25,4
				70378→; → 07/07; für Linkslenker; + DSTC	03.2125-7713.3	010819	ATE Ø 25,4
				68133→; → 07/07; für Linkslenker; - DSTC	03.2125-7743.3	010921	ATE Ø 25,4
D5 D5 AWD	136 136	04/05→12/08 05/05→08/07		12/05→ 07/07; für Rechtslenker	03.2125-7638.3	010738	ATE Ø 25,4
				12/05→ 07/07; für Linkslenker; + DSTC	03.2125-7713.3	010819	ATE Ø 25,4
				12/05→ 07/07; für Linkslenker; - DSTC	03.2125-7743.3	010921	ATE Ø 25,4
D5 AWD	120	07/02→08/07		03/03→ 07/07; für Rechtslenker; + DSTC	03.2125-7638.3	010738	ATE Ø 25,4
				68133→; → 07/07; für Rechtslenker; - DSTC	03.2125-7638.3	010738	ATE Ø 25,4
				03/03→ 07/07; für Linkslenker; + DSTC	03.2125-7713.3	010819	ATE Ø 25,4
				03/03→ 07/07; für Linkslenker; - DSTC	03.2125-7743.3	010921	ATE Ø 25,4
5 T AWD R 2	221 221	03/03→08/07 03/03→08/07		→ 07/07; für Rechtslenker; + DSTC	03.2125-7638.3	010738	ATE Ø 25,4
				→ 07/07; für Linkslenker; + DSTC	03.2125-7713.3	010819	ATE Ø 25,4
				→ 07/07; für Linkslenker; - DSTC	03.2125-7743.3	010921	ATE Ø 25,4
T5	191	04/04→08/07		→ 07/07; für Rechtslenker	03.2125-7638.3	010738	ATE Ø 25,4
				→ 07/07; für Linkslenker; + DSTC	03.2125-7713.3	010819	ATE Ø 25,4
				→ 07/07; für Linkslenker; - DSTC	03.2125-7743.3	010921	ATE Ø 25,4











VOLVO - V70 III (135) 04/07→04/16













 Bremskraftverstärker							
1.6 D 2.0 T	80 149	07/09→12/11 09/09→12/11		01/10→; für Linkslenker; für Fahrzeuge ohne Kollisionswarner	03.7755-9703.4	300239	ATE Ø 9 / 8" pneumatisch
1.6 DRIVe / D2 2.0 2.0 D 2.0 FlexiFuel T5	84 107 100 107 177	04/11→12/15 10/07→12/11 10/07→12/15 01/08→12/11 01/10→12/14		für Linkslenker; für Fahrzeuge ohne Kollisionswarner	03.7755-9703.4	300239	ATE Ø 9 / 8" pneumatisch
2.0 BiFuel 2.5 T 2.5 T FlexiFuel 3.2 3.2 AWD D3 D3 / D4 D5 D5 AWD T4 T4F →	157 147 147 175 - 179 179 100 120 158 - 169 151 - 169 132 132	03/13→12/15 08/07→12/09 05/08→12/09 08/07→12/14 04/10→12/15 10/07→12/15 03/10→12/15 03/11→04/16 12/09→04/16 10/10→12/15 01/11→12/15		→ 213000; für Fahrzeuge ohne Kollisionswarner	03.7755-9703.4	300239	ATE Ø 9 / 8" pneumatisch











	kw			 	! #		
VOLVO - V70 III (135) 04/07→04/16							
Bremskraftverstärker							
T6 AWD	210 - 242	08/07→04/16		→ 213000; für Fahrzeuge ohne Kollisionswarner		03.7755-9703.4 300239	ATE Ø 9 / 8" pneumatisch
2.4 D 3.2 AWD D5	120 175 136	04/07→12/10 04/07→12/10 04/07→12/09		08/07→; → 213000; für Fahrzeuge ohne Kollisionswarner		03.7755-9703.4 300239	ATE Ø 9 / 8" pneumatisch
2.4 D 2.5 T 2.5 T FlexiFuel	129 170 170	04/09→12/10 04/09→12/12 04/09→12/11		10/09→; → 213000; für Fahrzeuge ohne Kollisionswarner		03.7755-9703.4 300239	ATE Ø 9 / 8" pneumatisch
D4 D4 AWD T5	133 133 180	10/13→04/16 10/13→04/16 10/13→04/16		für Fahrzeuge ohne Kollisionswarner		03.7755-9703.4 300239	ATE Ø 9 / 8" pneumatisch
D5	151	10/08→12/11		12/09→; → 213000; für Fahrzeuge ohne Kollisionswarner		03.7755-9703.4 300239	ATE Ø 9 / 8" pneumatisch
D5 AWD	136	04/07→12/09		10/07→; → 213000; für Fahrzeuge ohne Kollisionswarner		03.7755-9703.4 300239	ATE Ø 9 / 8" pneumatisch
D5 AWD	158	04/11→12/15		06/11→; → 213000; für Fahrzeuge ohne Kollisionswarner		03.7755-9703.4 300239	ATE Ø 9 / 8" pneumatisch
Pedalwegsensord, Bremspedal							
1.6 D 2.0 T	80 149	07/09→12/11 09/09→12/11		01/10→; für Fahrzeuge mit Kollisionswarner		03.0655-0007.2 370007	ATE
1.6 DRIVE / D2 2.0 2.0 D 2.0 FlexiFuel D4 D4 AWD T5	84 107 100 107 133 120 - 133 177 - 180	04/11→12/15 10/07→12/11 10/07→12/15 01/08→12/11 10/13→04/16 10/07→04/16 01/10→04/16		für Fahrzeuge mit Kollisionswarner		03.0655-0007.2 370007	ATE
2.0 BiFuel	157	03/13→12/15		für Fahrzeuge mit Kollisionswarner		03.0655-0007.2 370007	ATE
				→ 213000; für Fahrzeuge mit Kollisionswarner		03.0655-0007.2 370007	ATE
2.0 GDI	157	04/12→12/15		03/13→; für Fahrzeuge mit Kollisionswarner		03.0655-0007.2 370007	ATE
2.4 D 3.2 AWD D5	120 175 136	04/07→12/10 04/07→12/10 04/07→12/09		08/07→; → 213000; für Fahrzeuge mit Kollisionswarner		03.0655-0007.2 370007	ATE
				213001→; für Fahrzeuge mit Kollisionswarner		03.0655-0007.2 370007	ATE
2.4 D 2.5 T 2.5 T FlexiFuel	129 170 170	04/09→12/10 04/09→12/12 04/09→12/11		10/09→; → 213000; für Fahrzeuge mit Kollisionswarner		03.0655-0007.2 370007	ATE
				213001→; für Fahrzeuge mit Kollisionswarner		03.0655-0007.2 370007	ATE
2.5 T 2.5 T FlexiFuel 3.2	147 147 175 - 179	08/07→12/09 05/08→12/09 08/07→12/14		→ 213000; für Fahrzeuge mit Kollisionswarner		03.0655-0007.2 370007	ATE
				213001→; für Fahrzeuge mit Kollisionswarner		03.0655-0007.2 370007	ATE
3.2 AWD D3 D3 / D4 D5	179 100 120 158 - 169	04/10→12/15 10/07→12/15 03/10→12/15 03/11→04/16					
D5 AWD	151 - 169	12/09→04/16					
T4 T4F T6 AWD	132 132 210 - 242	10/10→12/15 01/11→12/15 08/07→04/16					
D5	151	10/08→12/11		12/09→; → 213000; für Fahrzeuge mit Kollisionswarner		03.0655-0007.2 370007	ATE
				213001→; für Fahrzeuge mit Kollisionswarner		03.0655-0007.2 370007	ATE
D5 AWD	136	04/07→12/09		10/07→; → 213000; für Fahrzeuge mit Kollisionswarner		03.0655-0007.2 370007	ATE
				213001→; für Fahrzeuge mit Kollisionswarner		03.0655-0007.2 370007	ATE
D5 AWD	158	04/11→12/15		06/11→; → 213000; für Fahrzeuge mit Kollisionswarner		03.0655-0007.2 370007	ATE
				213001→; für Fahrzeuge mit Kollisionswarner		03.0655-0007.2 370007	ATE
Hauptbremszylinder							
D5 D5 AWD T6 AWD	169 169 224 - 242	03/11→04/16 03/11→04/16 01/10→04/16				24.4156-1391.3 011054	ATE Ø 27 ohne Bremsflüssigkeitsbehälter











	kw			 	! #		
VOLVO - V70 III Kasten/Kombi (135) 09/13→12/15							
Bremskraftverstärker							
2.0 D3 DRIVe 2.4 D5	100 158	09/13→12/15 09/13→12/15		→ 213000; für Fahrzeuge ohne Kollisionswarner	03.7755-9703.4	300239	ATE Ø 9 / 8" pneumatisch
Pedalwegsensord, Bremspedal							
2.0 D3 DRIVe 2.4 D5	100 158	09/13→12/15 09/13→12/15		→ 213000; für Fahrzeuge mit Kollisionswarner	03.0655-0007.2	370007	ATE
				213001→; für Fahrzeuge mit Kollisionswarner	03.0655-0007.2	370007	ATE
2.4 D4 AWD	120	09/13→12/15		für Fahrzeuge mit Kollisionswarner	03.0655-0007.2	370007	ATE
VOLVO - XC60 I SUV (156) 05/08→12/17							
Bremskraftverstärker							
2.4 D 3.2 AWD D3 / D4 D5 D5 AWD	129 175 120 158 151	04/09→12/10 07/09→12/10 03/10→12/14 06/11→02/17 07/09→06/11		für Fahrzeuge ohne Kollisionswarner	03.7755-0132.4	300265	ATE Ø 9 / 8" pneumatisch
				für Fahrzeuge mit Kollisionswarner	03.7858-5132.4	300276	ATE Ø 9 / 8" pneumatisch
2.4 D / D3 / D4 AWD D5 AWD T6 AWD	120 136 210	05/08→02/17 05/08→12/09 05/08→12/10		09/08→; für Fahrzeuge ohne Kollisionswarner	03.7755-0132.4	300265	ATE Ø 9 / 8" pneumatisch
				09/08→; für Fahrzeuge mit Kollisionswarner	03.7858-5132.4	300276	ATE Ø 9 / 8" pneumatisch
3.2 3.2 AWD D5 AWD T6 AWD	171 - 179 179 169 224	09/11→12/14 03/10→12/15 04/14→12/15 03/10→02/17		→ 236999; für Fahrzeuge ohne Kollisionswarner	03.7755-0132.4	300265	ATE Ø 9 / 8" pneumatisch
				→ 236999; für Fahrzeuge mit Kollisionswarner	03.7858-5132.4	300276	ATE Ø 9 / 8" pneumatisch
D3 D4	110 133 - 140	03/15→04/17 10/13→02/17		für Fahrzeuge ohne Kollisionswarner	03.7755-0132.4	300265	ATE Ø 9 / 8" pneumatisch
D4 AWD D5 AWD T6 AWD	133 - 140 162 242	10/13→02/17 03/15→02/17 04/14→12/15		→ 236999; für Fahrzeuge ohne Kollisionswarner	03.7755-0132.4	300265	ATE Ø 9 / 8" pneumatisch
				237000→; für Fahrzeuge ohne Kollisionswarner	03.7755-0132.4	300265	ATE Ø 9 / 8" pneumatisch
				→ 236999; für Fahrzeuge mit Kollisionswarner	03.7858-5132.4	300276	ATE Ø 9 / 8" pneumatisch
D5 AWD	158	04/11→12/15		06/11→; → 236999; für Fahrzeuge ohne Kollisionswarner	03.7755-0132.4	300265	ATE Ø 9 / 8" pneumatisch
				06/11→; → 236999; für Fahrzeuge mit Kollisionswarner	03.7858-5132.4	300276	ATE Ø 9 / 8" pneumatisch
T5 T5 AWD T6 T6 AWD	180 180 225 225	10/13→02/17 10/15→02/17 10/13→02/17 10/13→12/17		für Fahrzeuge ohne Kollisionswarner	03.7755-9703.4	300239	ATE Ø 9 / 8" pneumatisch
Pedalwegsensord, Bremspedal							
2.0 T	149	12/09→12/12		03/10→; für Fahrzeuge mit Kollisionswarner	03.0655-0007.2	370007	ATE
2.4 D 3.2 AWD D3 D3 / D4 D4	129 175 110 120 133 - 140	04/09→12/10 07/09→12/10 03/15→04/17 03/10→12/14 10/13→02/17		für Fahrzeuge mit Kollisionswarner	03.0655-0007.2	370007	ATE
D5 D5 AWD T5	158 151 177 - 180	06/11→02/17 07/09→06/11 09/10→02/17					
T5 AWD T6 T6 AWD	180 - 187 225 225	04/14→02/17 10/13→02/17 10/13→12/17					
2.4 D / D3 / D4 AWD D5 AWD T6 AWD	120 136 210	05/08→02/17 05/08→12/09 05/08→12/10		09/08→; für Fahrzeuge mit Kollisionswarner	03.0655-0007.2	370007	ATE
3.2	171 - 179	09/11→12/14		→ 236999; für Fahrzeuge mit Kollisionswarner	03.0655-0007.2	370007	ATE
3.2 AWD D4 AWD D5 AWD T6 AWD	179 133 - 140 162 - 169 224 - 242	03/10→12/15 10/13→02/17 04/14→02/17 03/10→02/17		237000→; für Fahrzeuge mit Kollisionswarner	03.0655-0007.2	370007	ATE
D5 AWD	158	04/11→12/15		06/11→; → 236999; für Fahrzeuge mit Kollisionswarner	03.0655-0007.2	370007	ATE
				237000→; für Fahrzeuge mit Kollisionswarner	03.0655-0007.2	370007	ATE











	kw					! #		
VOLVO - XC60 I VAN (156) 05/08→12/17								
 Bremskraftverstärker								
D4	120	09/13→02/17		für Fahrzeuge ohne Kollisionswarner		03.7755-0132.4	300265	ATE Ø 9 / 8" pneumatisch
D4 AWD	120	09/13→02/17		für Fahrzeuge mit Kollisionswarner		03.7858-5132.4	300276	ATE Ø 9 / 8" pneumatisch
D5 AWD	158	09/13→02/17						
Pedalwegsensord, Bremspedal								
D4	120	09/13→02/17		für Fahrzeuge mit Kollisionswarner		03.0655-0007.2	370007	ATE
D4 AWD	120	09/13→02/17						
D5 AWD	158	09/13→02/17						
VOLVO - XC70 I Cross Country (295) 10/97→10/07								
 Bremskraftverstärker								
2.4 T XC AWD	142 - 147	11/97→09/02		→ 12/01; - DSTC		03.7755-3402.4	300189	ATE Ø 9 / 8" pneumatisch
				01/02→; - DSTC		03.7755-4702.4	300224	ATE Ø 9 / 8" pneumatisch
				+ DSTC		03.7858-3532.4	300233	ATE Ø 9 / 8" pneumatisch
2.5 T XC AWD	154	09/02→08/07		→ 07/07; - DSTC		03.7755-4702.4	300224	ATE Ø 9 / 8" pneumatisch
D5 AWD	136	12/05→08/07						
D5 XC AWD	120	09/02→08/07		→ 07/07; + DSTC		03.7858-3532.4	300233	ATE Ø 9 / 8" pneumatisch
Pedalwegsensord, Bremspedal								
2.4 T XC AWD	142 - 147	11/97→09/02		→ 12/01		03.0655-0004.2	370004	ATE
						03.0655-0005.2	370005	ATE
				01/02→		03.0655-0005.2	370005	ATE
2.5 T XC AWD	154	09/02→08/07		→ 07/07		03.0655-0005.2	370005	ATE
D5 AWD	136	12/05→08/07						
D5 XC AWD	120	09/02→08/07						
 Hauptbremszylinder								
2.4 T XC AWD	142 - 147	11/97→09/02		11001→; für Rechtslenker; - DSTC		03.2125-7637.3	010707	ATE Ø 25,4
				→ 11000; für Linkslenker; - DSTC		03.2125-7637.3	010707	ATE Ø 25,4
				→ 69018; für Rechtslenker; + DSTC		03.2125-7637.3	010707	ATE Ø 25,4
				69019→; für Rechtslenker; + DSTC		03.2125-7638.3	010738	ATE Ø 25,4
				→ 11000; für Rechtslenker; - DSTC		03.2125-7638.3	010738	ATE Ø 25,4
				→ 66913; für Linkslenker; + DSTC		03.2125-7708.3	010739	ATE Ø 25,4
				66914→; für Linkslenker; + DSTC		03.2125-7713.3	010819	ATE Ø 25,4
				11001→; für Linkslenker; - DSTC		03.2125-7743.3	010921	ATE Ø 25,4
2.5 T XC AWD	154	09/02→08/07		→ 07/07; für Rechtslenker; - DSTC		03.2125-7637.3	010707	ATE Ø 25,4
D5 XC AWD	120	09/02→08/07		→ 07/07; für Rechtslenker; + DSTC		03.2125-7638.3	010738	ATE Ø 25,4
				→ 07/07; für Linkslenker; + DSTC		03.2125-7713.3	010819	ATE Ø 25,4
				→ 07/07; für Linkslenker; - DSTC		03.2125-7743.3	010921	ATE Ø 25,4
D5 AWD	136	12/05→08/07		→ 07/07; für Rechtslenker; - DSTC		03.2125-7637.3	010707	ATE Ø 25,4
				→ 07/07; für Linkslenker; + DSTC		03.2125-7713.3	010819	ATE Ø 25,4
				→ 07/07; für Linkslenker; - DSTC		03.2125-7743.3	010921	ATE Ø 25,4
VOLVO - XC70 II (136) 04/07→12/16								
 Bremskraftverstärker								
2.4 D	129	06/09→12/10		01/10→; für Fahrzeuge ohne Kollisionswarner		03.7755-0132.4	300265	ATE Ø 9 / 8" pneumatisch
				01/10→; für Fahrzeuge mit Kollisionswarner		03.7755-9703.4	300239	ATE Ø 9 / 8" pneumatisch
						03.7858-5132.4	300276	ATE Ø 9 / 8" pneumatisch
2.4 D / D4 AWD	120	08/07→04/16		für Fahrzeuge ohne Kollisionswarner		03.7755-0132.4	300265	ATE Ø 9 / 8" pneumatisch
3.2 AWD	175 - 179	08/07→12/14				03.7755-9703.4	300239	ATE Ø 9 / 8" pneumatisch
D3	120	04/10→12/15		für Fahrzeuge mit Kollisionswarner		03.7858-5132.4	300276	ATE Ø 9 / 8" pneumatisch
D5 AWD	158 - 169	04/11→04/16						
T5	180	10/13→12/16						
T6 AWD	210 - 224	01/08→12/16						
T6 Polestar AWD	242	11/13→12/16						
D4	133	10/13→04/16		für Fahrzeuge ohne Kollisionswarner		03.7755-9703.4	300239	ATE Ø 9 / 8" pneumatisch
D4 AWD	133	10/13→04/16						
T5 AWD	187	08/15→12/16						
T6 AWD	183	03/15→12/16						
D5 AWD	136	04/07→12/09		08/07→; für Fahrzeuge ohne Kollisionswarner		03.7755-0132.4	300265	ATE Ø 9 / 8" pneumatisch
				08/07→; für Fahrzeuge mit Kollisionswarner		03.7755-9703.4	300239	ATE Ø 9 / 8" pneumatisch
						03.7858-5132.4	300276	ATE Ø 9 / 8" pneumatisch
D5 AWD	151	04/09→12/11		12/09→; für Fahrzeuge ohne Kollisionswarner		03.7755-0132.4	300265	ATE Ø 9 / 8" pneumatisch
						03.7755-9703.4	300239	ATE Ø 9 / 8" pneumatisch
→								











	kw					! #						
VOLVO - XC70 II (136) 04/07→12/16												
 Bremskraftverstärker												
D5 AWD	151	04/09→12/11		12/09→; für Fahrzeuge mit Kollisionswarner		03.7858-5132.4	300276	ATE Ø 9 / 8" pneumatisch				
Pedalwegsensord, Bremspedal												
2.4 D	129	06/09→12/10		01/10→; für Fahrzeuge mit Kollisionswarner		03.0655-0007.2	370007	ATE				
2.4 D / D4 AWD	120	08/07→04/16		für Fahrzeuge mit Kollisionswarner		03.0655-0007.2	370007	ATE				
3.2 AWD	175 - 179	08/07→12/14										
D3	120	04/10→12/15										
D5 AWD	158 - 169	04/11→04/16										
T5	180	10/13→12/16										
T6 AWD	210 - 224	01/08→12/16										
T6 Polestar AWD	242	11/13→12/16										
D5 AWD	136	04/07→12/09			08/07→; für Fahrzeuge mit Kollisionswarner					03.0655-0007.2	370007	ATE
D5 AWD	151	04/09→12/11		12/09→; für Fahrzeuge mit Kollisionswarner		03.0655-0007.2	370007	ATE				
VOLVO - XC70 II VAN (136) 04/07→12/16												
 Bremskraftverstärker												
2.0 D4	120	09/13→12/16		für Fahrzeuge ohne Kollisionswarner		03.7755-0132.4	300265	ATE Ø 9 / 8" pneumatisch				
2.4 D4 AWD	120	09/13→04/16		für Fahrzeuge mit Kollisionswarner		03.7755-9703.4	300239	ATE Ø 9 / 8" pneumatisch				
2.4 D5 AWD	158	09/13→12/16										
						03.7858-5132.4	300276	ATE Ø 9 / 8" pneumatisch				
Pedalwegsensord, Bremspedal												
2.0 D4	120	09/13→12/16		für Fahrzeuge mit Kollisionswarner		03.0655-0007.2	370007	ATE				
2.4 D4 AWD	120	09/13→04/16										
2.4 D5 AWD	158	09/13→12/16										
VOLVO - XC90 I (275) 06/02→01/15												
 Bremskraftverstärker												
2.5	153	01/03→12/06		für Linkslenker; Felgenreöße [Zoll]: 18,0		03.7858-3032.4	300257	ATE Ø 9 / 8" pneumatisch				
2.5 AWD	153	06/02→12/14		für Linkslenker		03.7858-3632.4	300234	ATE Ø 9 / 8" pneumatisch				
2.5 T AWD	154	10/02→09/14										
D3 / D5	120	04/09→12/14										
D5 AWD	120 - 136	10/02→12/12										
T6 AWD	200	10/02→12/06										
V8 AWD	232 - 235	09/04→12/10										
3.2	175 - 179	09/11→09/14										
3.2 AWD	179	04/10→09/14										
D5 AWD	147 - 155	01/11→12/14										
3.2 AWD	175	03/06→12/10		05/06→; für Linkslenker; Felgenreöße [Zoll]: 18,0		03.7858-3032.4	300257	ATE Ø 9 / 8" pneumatisch				
				05/06→; für Linkslenker		03.7858-3632.4	300234	ATE Ø 9 / 8" pneumatisch				
Pedalwegsensord, Bremspedal												
2.5	153	01/03→12/06				03.0655-0005.2	370005	ATE				
2.5 AWD	153	06/02→12/14										
2.5 T AWD	154	10/02→09/14										
3.2	175 - 179	09/11→09/14										
3.2 AWD	179	04/10→09/14										
D3 / D5	120	04/09→12/14										
D5 AWD	120 - 155	10/02→12/14										
T6 AWD	200	10/02→12/06										
V8 AWD	232 - 235	09/04→12/10										
3.2 AWD	175	03/06→12/10			05/06→					03.0655-0005.2	370005	ATE
D5 AWD	136	04/05→12/12										
 Hauptbremszylinder												
2.5	153	01/03→12/06			für Rechtslenker					03.2125-7638.3	010738	ATE Ø 25,4
2.5 AWD	153	06/02→12/14			für Linkslenker					03.2125-7713.3	010819	ATE Ø 25,4
2.5 T AWD	154	10/02→09/14										
D3 / D5	120	04/09→12/14										
D5 AWD	120 - 155	10/02→12/14										
3.2	175 - 179	09/11→09/14										
→												













	kw					! #		
VOLVO - XC90 I (275) 06/02→01/15								
 Hauptbremszylinder								
3.2 AWD T6 AWD V8 AWD	179 200 232 - 235	04/10→09/14 10/02→12/06 09/04→12/10		für Linkslenker			03.2125-7713.3 010819	ATE Ø 25,4
3.2 AWD	175	03/06→12/10		05/06→; für Linkslenker			03.2125-7713.3 010819	ATE Ø 25,4
D5 AWD	136	04/05→12/12		05/06→; für Rechtslenker			03.2125-7638.3 010738	ATE Ø 25,4
				05/06→; für Linkslenker			03.2125-7713.3 010819	ATE Ø 25,4
VOLVO - XC90 I VAN (275) 06/02→01/15								
 Bremskraftverstärker								
2.4 D4	120	09/13→12/14		für Linkslenker; Felgengröße [Zoll]: 18,0			03.7858-3032.4 300257	ATE Ø 9 / 8" pneumatisch
				für Linkslenker			03.7858-3632.4 300234	ATE Ø 9 / 8" pneumatisch
2.4 D5 AWD	147	09/13→12/14		für Linkslenker			03.7858-3632.4 300234	ATE Ø 9 / 8" pneumatisch
Pedalwegsensoren, Bremspedal								
2.4 D4	120	09/13→12/14					03.0655-0005.2 370005	ATE
2.4 D5 AWD	147	09/13→12/14						
 Hauptbremszylinder								
2.4 D4	120	09/13→12/14		für Rechtslenker			03.2125-7638.3 010738	ATE Ø 25,4
2.4 D5 AWD	147	09/13→12/14		für Linkslenker			03.2125-7713.3 010819	ATE Ø 25,4
VW - AMAROK (2HA, 2HB, S1B, S6B, S7A, S7B) 09/10→								
 Hauptbremszylinder								
2.0 BiTDI	120 - 132	09/10→05/22					03.2126-5132.3 011012	ATE Ø 27
2.0 BiTDI 4motion	120 - 132	09/10→05/22					24.2126-3131.3 011038	ATE Ø 27 ohne Bremsflüssigkeitsbehälter
2.0 TDI	90 - 103	09/10→05/22						
2.0 TDI 4motion	90 - 103	09/10→05/22						
2.0 TSI	118	12/10→10/16						
3.0 TDI	120	06/16→08/19						
3.0 TDI 4motion	150 - 190	06/16→05/22						
3.0 TDI 4motion	120 - 165	06/16→05/22		09/16→			03.2126-5132.3 011012	ATE Ø 27
							24.2126-3131.3 011038	ATE Ø 27 ohne Bremsflüssigkeitsbehälter
VW - AMAROK Pritsche/Fahrgestell (S1B, S6B, S7B) 09/11→05/22								
 Hauptbremszylinder								
2.0 BiTDI	132	09/11→07/19		11/11→			03.2126-5132.3 011012	ATE Ø 27
							24.2126-3131.3 011038	ATE Ø 27 ohne Bremsflüssigkeitsbehälter
2.0 BiTDI 4motion	132	09/11→07/19		11/11→			03.2126-5132.3 011012	ATE Ø 27
							24.2126-3131.3 011038	ATE Ø 27 ohne Bremsflüssigkeitsbehälter
2.0 TDI	90 - 103	09/11→10/16		07/12→			03.2126-5132.3 011012	ATE Ø 27
							24.2126-3131.3 011038	ATE Ø 27 ohne Bremsflüssigkeitsbehälter
2.0 TDI 4motion	103	09/11→10/16		06/12→			03.2126-5132.3 011012	ATE Ø 27
							24.2126-3131.3 011038	ATE Ø 27 ohne Bremsflüssigkeitsbehälter
3.0 TDI 4motion	150 - 190	06/16→05/22					03.2126-5132.3 011012	ATE Ø 27
							24.2126-3131.3 011038	ATE Ø 27 ohne Bremsflüssigkeitsbehälter
VW - ARTEON (3H7, 3H8) 03/17→								
 Hauptbremszylinder								
1.4 eHybrid	160	11/20→		für Linkslenker; Herstellereinschränkung			24.4153-1522.3 011048	ATE Ø 23,8 ohne Bremsflüssigkeitsbehälter
1.5 TSI	110	11/17→07/19		ATE				
2.0 TDI	110 - 147	03/17→						
2.0 TDI 4motion	140 - 176	03/17→						
2.0 TSI	140	05/17→						
2.0 TSI 4motion	200 - 206	04/17→02/22						
2.0 TSI R	235	11/20→						













	kw					! #		
VW - ARTEON SHOOTING BRAKE (3H9) 06/20→								
 Hauptbremszylinder								
1.4 eHybrid 1.5 TSi 2.0 TDI 2.0 TDI 4motion 2.0 TSi 2.0 TSi 4motion 2.0 TSI 4motion 2.0 TSI R	160 110 110 147 140 140 200 206 235	11/20→ 08/20→ 09/20→ 09/20→ 09/20→ 06/20→ 06/20→ 11/20→		für Linkslenker; Herstellereinschränkung ATE			24.4153-1522.3 011048	ATE Ø 23,8 ohne Bremsflüssigkeitsbehälter
VW - BEETLE (5C1, 5C2) 04/11→07/19								
 Bremskraftverstärker								
1.4 TSI 2.0 TFSI 2.0 TSI	118 147 155	10/11→07/16 04/11→07/16 12/12→07/19		für Rechtslenker; +PR 1ZA für Rechtslenker; +PR 1ZA / 1ZB 05/13→; für Rechtslenker; +PR 1ZA / 1ZB			03.7848-9802.4 300344 03.7848-9802.4 300344 03.7848-9802.4 300344	ATE Ø 7 / 8" pneumatisch ATE Ø 7 / 8" pneumatisch ATE Ø 7 / 8" pneumatisch
 Hauptbremszylinder								
1.2 TSI 1.2 TSI 16V 1.6 TDI	77 77 77	07/11→07/19 12/14→07/19 10/11→07/16		für Linkslenker			24.2122-1788.3 011145	FTE Ø 22,2 ohne Bremsflüssigkeitsbehälter
1.4 TSI 2.0 TSI	110 130 - 162	12/14→07/19 12/14→07/19		für Linkslenker			24.2122-1788.3 011145	FTE Ø 22,2 ohne Bremsflüssigkeitsbehälter
				für Rechtslenker			24.4153-0202.3 011027	ATE Ø 23,8 ohne Bremsflüssigkeitsbehälter
1.4 TSI	118	10/11→07/16		für Linkslenker; +PR 1ZP			24.2122-1788.3 011145	FTE Ø 22,2 ohne Bremsflüssigkeitsbehälter
				für Rechtslenker; +PR 1ZP			24.4152-0132.3 011025	ATE Ø 22,2 ohne Bremsflüssigkeitsbehälter
				für Rechtslenker; +PR 1ZA			24.4153-0202.3 011027	ATE Ø 23,8 ohne Bremsflüssigkeitsbehälter
2.0 TDI	81	06/14→09/18		12/14→; für Linkslenker			24.2122-1788.3 011145	FTE Ø 22,2 ohne Bremsflüssigkeitsbehälter
				12/14→; für Rechtslenker			24.4153-0202.3 011027	ATE Ø 23,8 ohne Bremsflüssigkeitsbehälter
2.0 TDI	103	04/11→07/16		für Linkslenker; +PR 1ZP			24.2122-1788.3 011145	FTE Ø 22,2 ohne Bremsflüssigkeitsbehälter
				für Rechtslenker; +PR 1ZP			24.4152-0132.3 011025	ATE Ø 22,2 ohne Bremsflüssigkeitsbehälter
2.0 TDI	110	07/14→09/18		09/14→; für Linkslenker; +PR 1ZP			24.2122-1788.3 011145	FTE Ø 22,2 ohne Bremsflüssigkeitsbehälter
				09/14→; +PR 1ZP; für Rechtslenker			24.4152-0132.3 011025	ATE Ø 22,2 ohne Bremsflüssigkeitsbehälter
2.0 TFSI	147	04/11→07/16		für Linkslenker; +PR 1LV			24.2122-1788.3 011145	FTE Ø 22,2 ohne Bremsflüssigkeitsbehälter
				für Rechtslenker; +PR 1LV			24.4152-0132.3 011025	ATE Ø 22,2 ohne Bremsflüssigkeitsbehälter
				für Rechtslenker; +PR 1ZA / 1ZB			24.4153-0202.3 011027	ATE Ø 23,8 ohne Bremsflüssigkeitsbehälter
2.0 TSI	155	12/12→07/19		05/13→; für Linkslenker; +PR 1LV			24.2122-1788.3 011145	FTE Ø 22,2 ohne Bremsflüssigkeitsbehälter
				05/13→; für Rechtslenker; +PR 1LV			24.4152-0132.3 011025	ATE Ø 22,2 ohne Bremsflüssigkeitsbehälter
				05/13→; für Rechtslenker; +PR 1ZA / 1ZB			24.4153-0202.3 011027	ATE Ø 23,8 ohne Bremsflüssigkeitsbehälter
2.5	125	04/11→07/19		für Linkslenker; +PR 1ZP			24.2122-1788.3 011145	FTE Ø 22,2 ohne Bremsflüssigkeitsbehälter
VW - BEETLE Cabriolet (5C7, 5C8) 12/11→07/19								
 Bremskraftverstärker								
1.2 TSI 1.6 TDI 2.5	77 77 125	12/11→07/19 12/11→07/16 12/11→07/16		12/12→; für Rechtslenker			03.7848-9802.4 300344	ATE Ø 7 / 8" pneumatisch
1.2 TSI 16V 1.4 TSI 2.0 TSI	77 110 162	12/14→07/19 12/14→09/18 12/14→09/18		für Rechtslenker			03.7848-9802.4 300344	ATE Ø 7 / 8" pneumatisch
1.4 TSI	118	12/11→07/16		11/12→; +PR 1ZA; für Rechtslenker			03.7848-9802.4 300344	ATE Ø 7 / 8" pneumatisch
2.0 TDI	81	06/14→09/18		12/14→; für Rechtslenker			03.7848-9802.4 300344	ATE Ø 7 / 8" pneumatisch
2.0 TDI	103	04/12→07/16		11/12→; +PR 1ZE; für Rechtslenker			03.7848-9802.4 300344	ATE Ø 7 / 8" pneumatisch
→								













	kw				! #		
VW - BEETLE Cabriolet (5C7, 5C8) 12/11→07/19							
 Bremskraftverstärker							
2.0 TDI	110	09/14→09/18		für Rechtslenker; +PR 1ZE		03.7848-9802.4 300344	ATE Ø 7 / 8" pneumatisch
2.0 TFSI	147	12/11→07/16		11/12→; +PR 1ZA / 1ZB; für Rechtslenker		03.7848-9802.4 300344	ATE Ø 7 / 8" pneumatisch
2.0 TSI	155	12/12→07/19		05/13→; +PR 1ZA / 1ZB; für Rechtslenker		03.7848-9802.4 300344	ATE Ø 7 / 8" pneumatisch
 Hauptbremszylinder							
1.2 TSI 1.6 TDI	77	12/11→07/19		11/12→; für Linkslenker		24.2122-1788.3 011145	FTE Ø 22,2 ohne Bremsflüssigkeitsbehälter
	77	12/11→07/16		11/12→; für Rechtslenker		24.4152-0132.3 011025	ATE Ø 22,2 ohne Bremsflüssigkeitsbehälter
1.2 TSI 16V	77	12/14→07/19		für Linkslenker		24.2122-1788.3 011145	FTE Ø 22,2 ohne Bremsflüssigkeitsbehälter
				für Rechtslenker		24.4152-0132.3 011025	ATE Ø 22,2 ohne Bremsflüssigkeitsbehälter
1.4 TSI 2.0 TSI	110 162	12/14→09/18		für Linkslenker		24.2122-1788.3 011145	FTE Ø 22,2 ohne Bremsflüssigkeitsbehälter
				für Rechtslenker		24.4153-0202.3 011027	ATE Ø 23,8 ohne Bremsflüssigkeitsbehälter
1.4 TSI	118	12/11→07/16		11/12→; für Linkslenker; +PR 1ZP		24.2122-1788.3 011145	FTE Ø 22,2 ohne Bremsflüssigkeitsbehälter
				11/12→; für Rechtslenker; +PR 1ZP		24.4152-0132.3 011025	ATE Ø 22,2 ohne Bremsflüssigkeitsbehälter
				11/12→; +PR 1ZA; für Rechtslenker		24.4153-0202.3 011027	ATE Ø 23,8 ohne Bremsflüssigkeitsbehälter
2.0 TDI	81	06/14→09/18		12/14→; für Linkslenker		24.2122-1788.3 011145	FTE Ø 22,2 ohne Bremsflüssigkeitsbehälter
				12/14→; für Rechtslenker		24.4153-0202.3 011027	ATE Ø 23,8 ohne Bremsflüssigkeitsbehälter
2.0 TDI	103	04/12→07/16		11/12→; für Linkslenker; +PR 1ZP		24.2122-1788.3 011145	FTE Ø 22,2 ohne Bremsflüssigkeitsbehälter
				11/12→; für Rechtslenker; +PR 1ZP		24.4152-0132.3 011025	ATE Ø 22,2 ohne Bremsflüssigkeitsbehälter
				11/12→; +PR 1ZE; für Rechtslenker		24.4153-0202.3 011027	ATE Ø 23,8 ohne Bremsflüssigkeitsbehälter
2.0 TDI	110	09/14→09/18		für Linkslenker; +PR 1ZP		24.2122-1788.3 011145	FTE Ø 22,2 ohne Bremsflüssigkeitsbehälter
				für Rechtslenker; +PR 1ZP		24.4152-0132.3 011025	ATE Ø 22,2 ohne Bremsflüssigkeitsbehälter
				für Rechtslenker; +PR 1ZE		24.4153-0202.3 011027	ATE Ø 23,8 ohne Bremsflüssigkeitsbehälter
2.0 TFSI	147	12/11→07/16		11/12→; für Linkslenker; +PR 1LV		24.2122-1788.3 011145	FTE Ø 22,2 ohne Bremsflüssigkeitsbehälter
				11/12→; für Rechtslenker; +PR 1LV		24.4152-0132.3 011025	ATE Ø 22,2 ohne Bremsflüssigkeitsbehälter
				11/12→; +PR 1ZA / 1ZB; für Rechtslenker		24.4153-0202.3 011027	ATE Ø 23,8 ohne Bremsflüssigkeitsbehälter
2.0 TSI	155	12/12→07/19		05/13→; für Linkslenker; +PR 1LV		24.2122-1788.3 011145	FTE Ø 22,2 ohne Bremsflüssigkeitsbehälter
				05/13→; für Rechtslenker; +PR 1LV		24.4152-0132.3 011025	ATE Ø 22,2 ohne Bremsflüssigkeitsbehälter
				05/13→; für Rechtslenker; +PR 1ZA / 1ZB		24.4153-0202.3 011027	ATE Ø 23,8 ohne Bremsflüssigkeitsbehälter
2.5	125	12/11→07/16		12/12→; für Linkslenker		24.2122-1788.3 011145	FTE Ø 22,2 ohne Bremsflüssigkeitsbehälter
				12/12→; für Rechtslenker		24.4152-0132.3 011025	ATE Ø 22,2 ohne Bremsflüssigkeitsbehälter
						24.4153-0202.3 011027	ATE Ø 23,8 ohne Bremsflüssigkeitsbehälter
VW - BORA (9M2) 01/05→12/14							
 Bremskraftverstärker							
2.0	85	01/05→12/14		→ 1J-2-373846; für Linkslenker; + ESP		03.7860-0602.4 300141	ATE Ø 10" pneumatisch
				für Linkslenker; + ESP		03.7863-0402.4 300124	ATE Ø 10" pneumatisch
				1J-2-373847→; für Linkslenker; + ESP		03.7863-3502.4 300128	ATE Ø 10" pneumatisch
 Hauptbremszylinder							
2.0	85	01/05→12/14		für Linkslenker; + ESP		03.2123-2024.3 010597	ATE Ø 23,8
						03.2123-2715.3 010802	ATE Ø 23,8
→							













	kw					! #		
VW - BORA (9M2) 01/05→12/14								
 Hauptbremszylinder								
2.0	85	01/05→12/14			für Rechtslenker; + ESP		03.2123-2774.3 010803	ATE Ø 23,8
					für Linkslenker; - ESP		24.2123-1709.3 010503	Ø 23,8
VW - BORA I (1J2) 10/98→12/13								
 Bremskraftverstärker								
1.4 16V 1.6	55 74 - 75	03/00→05/05 10/98→05/05			09/00→; → 1J-2-373846; für Linkslenker; + ESP		03.7860-0602.4 300141	ATE Ø 10" pneumatisch
					→ 08/00; für Linkslenker; + ESP		03.7863-0402.4 300124	ATE Ø 10" pneumatisch
1.6 16V 1.8 1.8 4motion 1.9 SDI 2.0	77 92 92 50 85	05/00→05/05 10/98→05/05 02/99→05/05 10/98→05/05 10/98→12/13			1J-2-373847→; für Linkslenker; + ESP; → 12/04		03.7863-3502.4 300128	ATE Ø 10" pneumatisch
1.6 FSI 1.9 TDI 1.9 TDI 4motion 2.0 4motion 2.3 V5 2.3 V5 4motion	81 74 74 85 125 125	01/02→05/05 09/00→05/05 09/00→05/05 04/00→05/05 10/00→05/05 10/00→05/05			→ 1J-2-373846; für Linkslenker; + ESP		03.7860-0602.4 300141	ATE Ø 10" pneumatisch
					1J-2-373847→; für Linkslenker; + ESP; → 12/04		03.7863-3502.4 300128	ATE Ø 10" pneumatisch
1.8 T	110	05/00→05/05			09/00→; → 1J-2-373846; für Linkslenker; + ESP		03.7860-0602.4 300141	ATE Ø 10" pneumatisch
					1J-2-373847→; für Linkslenker; + ESP; → 12/04		03.7863-3502.4 300128	ATE Ø 10" pneumatisch
1.8 T	132	03/02→05/05			05/02→; für Linkslenker; + ESP; → 12/04		03.7863-3502.4 300128	ATE Ø 10" pneumatisch
1.9 TDI	66	10/98→05/05			09/00→ 06/01; für Linkslenker; + ESP		03.7860-0602.4 300141	ATE Ø 10" pneumatisch
					→ 08/00; für Linkslenker; + ESP		03.7863-0402.4 300124	ATE Ø 10" pneumatisch
1.9 TDI 1.9 TDI 4motion	81 85	10/98→06/01 02/99→06/01			09/00→; für Linkslenker; + ESP		03.7860-0602.4 300141	ATE Ø 10" pneumatisch
					→ 08/00; für Linkslenker; + ESP		03.7863-0402.4 300124	ATE Ø 10" pneumatisch
1.9 TDI 1.9 TDI 4motion	85 66	12/98→01/02 11/98→04/02			09/00→ 06/01; für Linkslenker; + ESP		03.7860-0602.4 300141	ATE Ø 10" pneumatisch
					02/99→ 08/00; für Linkslenker; + ESP		03.7863-0402.4 300124	ATE Ø 10" pneumatisch
1.9 TDI 1.9 TDI 4motion	96 96	11/00→05/05 11/00→05/05			04/01→; → 1J-2-373846; für Linkslenker; + ESP		03.7860-0602.4 300141	ATE Ø 10" pneumatisch
					1J-2-373847→; für Linkslenker; + ESP; → 12/04		03.7863-3502.4 300128	ATE Ø 10" pneumatisch
1.9 TDI 1.9 TDI 4motion	110 110	05/00→05/05 05/00→05/05			10/00→; → 1J-2-373846; für Linkslenker; + ESP		03.7860-0602.4 300141	ATE Ø 10" pneumatisch
					1J-2-373847→; für Linkslenker; + ESP; → 12/04		03.7863-3502.4 300128	ATE Ø 10" pneumatisch
2.3 V5	110	10/98→10/00			09/00→; → 1J-2-373846; für Linkslenker; + ESP		03.7860-0602.4 300141	ATE Ø 10" pneumatisch
					→ 08/00; für Linkslenker; + ESP		03.7863-0402.4 300124	ATE Ø 10" pneumatisch
					1J-2-373847→; für Linkslenker; + ESP		03.7863-3502.4 300128	ATE Ø 10" pneumatisch
2.3 V5 4motion	110	12/98→10/00			09/00→; → 1J-2-373846; für Linkslenker; + ESP		03.7860-0602.4 300141	ATE Ø 10" pneumatisch
					02/99→ 08/00; für Linkslenker; + ESP		03.7863-0402.4 300124	ATE Ø 10" pneumatisch
					1J-2-373847→; für Linkslenker; + ESP		03.7863-3502.4 300128	ATE Ø 10" pneumatisch
2.8 V6 4motion	150	03/99→05/05			09/00→; → 1J-2-373846; für Linkslenker; + ESP		03.7860-0602.4 300141	ATE Ø 10" pneumatisch
					05/99→ 08/00; für Linkslenker; + ESP		03.7863-0402.4 300124	ATE Ø 10" pneumatisch
					1J-2-373847→; für Linkslenker; + ESP; → 12/04		03.7863-3502.4 300128	ATE Ø 10" pneumatisch
 Hauptbremszylinder								
1.4 16V 1.6	55 74 - 75	03/00→05/05 10/98→05/05			→ 08/00; + ESP; für Linkslenker		03.2123-2024.3 010597	ATE Ø 23,8
					09/00→; + ESP; für Linkslenker; → 12/04		03.2123-2715.3 010802	ATE Ø 23,8
1.6 16V 1.8 1.8 4motion 1.9 SDI 2.0	77 92 92 50 85	05/00→05/05 10/98→05/05 02/99→05/05 10/98→05/05 10/98→12/13			09/00→; + ESP; für Rechtslenker; → 12/04		03.2123-2774.3 010803	ATE Ø 23,8
					für Linkslenker; - ESP; → 12/04		24.2123-1709.3 010503	Ø 23,8
1.6 FSI 1.9 TDI 1.9 TDI 4motion 2.0 4motion 2.3 V5 2.3 V5 4motion	81 74 74 85 125 125	01/02→05/05 09/00→05/05 09/00→05/05 04/00→05/05 10/00→05/05 10/00→05/05			für Linkslenker; + ESP; → 12/04		03.2123-2715.3 010802	ATE Ø 23,8
					für Rechtslenker; + ESP; → 12/04		03.2123-2774.3 010803	ATE Ø 23,8
					für Linkslenker; - ESP; → 12/04		24.2123-1709.3 010503	Ø 23,8
1.8 T	110	05/00→05/05			09/00→; + ESP; für Linkslenker; → 12/04		03.2123-2715.3 010802	ATE Ø 23,8
					09/00→; + ESP; für Rechtslenker; → 12/04		03.2123-2774.3 010803	ATE Ø 23,8
					09/00→; für Linkslenker; - ESP; → 12/04		24.2123-1709.3 010503	Ø 23,8
1.8 T →	132	03/02→05/05			05/02→; für Linkslenker; + ESP; → 12/04		03.2123-2715.3 010802	ATE Ø 23,8













	kw			 	! #		
VW - BORA I (1J2) 10/98→12/13							
 Hauptbremszylinder							
1.8 T	132	03/02→05/05		05/02→; für Rechtslenker; + ESP; → 12/04	03.2123-2774.3	010803	ATE Ø 23,8
				05/02→; für Linkslenker; - ESP; → 12/04	24.2123-1709.3	010503	Ø 23,8
1.9 TDI	66	10/98→05/05		→ 08/00; + ESP; für Linkslenker	03.2123-2024.3	010597	ATE Ø 23,8
				09/00→ 06/01; für Linkslenker; + ESP	03.2123-2715.3	010802	ATE Ø 23,8
				09/00→ 06/01; für Rechtslenker; + ESP	03.2123-2774.3	010803	ATE Ø 23,8
				→ 06/01; für Linkslenker; - ESP	24.2123-1709.3	010503	Ø 23,8
1.9 TDI	81	10/98→06/01		→ 08/00; + ESP; für Linkslenker	03.2123-2024.3	010597	ATE Ø 23,8
1.9 TDI 4motion	85	02/99→06/01		09/00→; + ESP; für Linkslenker	03.2123-2715.3	010802	ATE Ø 23,8
2.3 V5	110	10/98→10/00		09/00→; + ESP; für Rechtslenker	03.2123-2774.3	010803	ATE Ø 23,8
				- ESP; für Linkslenker	24.2123-1709.3	010503	Ø 23,8
1.9 TDI	85	12/98→01/02		02/99→ 08/00; für Linkslenker; + ESP	03.2123-2024.3	010597	ATE Ø 23,8
1.9 TDI 4motion	66	11/98→04/02		09/00→ 06/01; für Linkslenker; + ESP	03.2123-2715.3	010802	ATE Ø 23,8
				09/00→ 06/01; für Rechtslenker; + ESP	03.2123-2774.3	010803	ATE Ø 23,8
				02/99→ 06/01; für Linkslenker; - ESP	24.2123-1709.3	010503	Ø 23,8
1.9 TDI	96	11/00→05/05		04/01→; für Linkslenker; + ESP; → 12/04	03.2123-2715.3	010802	ATE Ø 23,8
1.9 TDI 4motion	96	11/00→05/05		04/01→; für Rechtslenker; + ESP; → 12/04	03.2123-2774.3	010803	ATE Ø 23,8
				04/01→; für Linkslenker; - ESP; → 12/04	24.2123-1709.3	010503	Ø 23,8
1.9 TDI	110	05/00→05/05		10/00→; für Linkslenker; + ESP; → 12/04	03.2123-2715.3	010802	ATE Ø 23,8
1.9 TDI 4motion	110	05/00→05/05		10/00→; für Rechtslenker; + ESP; → 12/04	03.2123-2774.3	010803	ATE Ø 23,8
				10/00→; für Linkslenker; - ESP; → 12/04	24.2123-1709.3	010503	Ø 23,8
2.3 V5 4motion	110	12/98→10/00		02/99→ 08/00; für Linkslenker; + ESP	03.2123-2024.3	010597	ATE Ø 23,8
				09/00→; + ESP; für Linkslenker	03.2123-2715.3	010802	ATE Ø 23,8
				09/00→; + ESP; für Rechtslenker	03.2123-2774.3	010803	ATE Ø 23,8
				02/99→; für Linkslenker; - ESP	24.2123-1709.3	010503	Ø 23,8
2.8 V6 4motion	150	03/99→05/05		05/99→ 08/00; + ESP; für Linkslenker	03.2123-2024.3	010597	ATE Ø 23,8
				09/00→; + ESP; für Linkslenker; → 12/04	03.2123-2715.3	010802	ATE Ø 23,8
				09/00→; + ESP; für Rechtslenker; → 12/04	03.2123-2774.3	010803	ATE Ø 23,8
				05/99→; für Linkslenker; - ESP; → 12/04	24.2123-1709.3	010503	Ø 23,8
VW - BORA Variant (1J6) 05/99→05/05							
 Bremskraftverstärker							
1.4 16V	55	09/01→05/05		→ 1J-2-373846; für Linkslenker; + ESP	03.7860-0602.4	300141	ATE Ø 10" pneumatisch
1.6 FSI	81	01/02→05/05					
1.9 TDI	74 - 110	09/00→05/05		1J-2-373847→; für Linkslenker; + ESP; → 12/04	03.7863-3502.4	300128	ATE Ø 10" pneumatisch
1.9 TDI 4motion	74 - 110	09/00→05/05					
2.0 4motion	85	04/00→05/05					
2.3 V5	125	10/00→05/05					
2.3 V5 4motion	125	10/00→05/05					
1.6	74 - 75	05/99→05/05		09/00→; → 1J-2-373846; für Linkslenker; + ESP	03.7860-0602.4	300141	ATE Ø 10" pneumatisch
1.6 16V	77	02/00→05/05					
1.8 4motion	92	05/99→05/05		→ 08/00; für Linkslenker; + ESP	03.7863-0402.4	300124	ATE Ø 10" pneumatisch
2.0	85	05/99→05/05		1J-2-373847→; für Linkslenker; + ESP; → 12/04	03.7863-3502.4	300128	ATE Ø 10" pneumatisch
2.8 V6 4motion	150	05/99→05/05					
1.8 T	110	05/00→05/05		09/00→; → 1J-2-373846; für Linkslenker; + ESP	03.7860-0602.4	300141	ATE Ø 10" pneumatisch
				1J-2-373847→; für Linkslenker; + ESP; → 12/04	03.7863-3502.4	300128	ATE Ø 10" pneumatisch
1.8 T	132	05/02→05/05		für Linkslenker; + ESP; → 12/04	03.7863-3502.4	300128	ATE Ø 10" pneumatisch
1.9 TDI	81 - 85	05/99→06/01		09/00→; für Linkslenker; + ESP	03.7860-0602.4	300141	ATE Ø 10" pneumatisch
1.9 TDI 4motion	85	05/99→06/01		→ 08/00; für Linkslenker; + ESP	03.7863-0402.4	300124	ATE Ø 10" pneumatisch
1.9 TDI	96	11/00→05/05		04/01→; → 1J-2-373846; für Linkslenker; + ESP	03.7860-0602.4	300141	ATE Ø 10" pneumatisch
1.9 TDI 4motion	96	11/00→05/05		1J-2-373847→; für Linkslenker; + ESP; → 12/04	03.7863-3502.4	300128	ATE Ø 10" pneumatisch
2.3 V5	110	05/99→10/00		09/00→; → 1J-2-373846; für Linkslenker; + ESP	03.7860-0602.4	300141	ATE Ø 10" pneumatisch
2.3 V5 4motion	110	05/99→10/00		→ 08/00; für Linkslenker; + ESP	03.7863-0402.4	300124	ATE Ø 10" pneumatisch
				1J-2-373847→; für Linkslenker; + ESP	03.7863-3502.4	300128	ATE Ø 10" pneumatisch
 Hauptbremszylinder							
1.4 16V	55	09/01→05/05		für Linkslenker; + ESP; → 12/04	03.2123-2715.3	010802	ATE Ø 23,8













	kw					! #		
VW - BORA Variant (1J6) 05/99→05/05								
 Hauptbremszylinder								
1.6 FSI	81	01/02→05/05		für Rechtslenker; + ESP; → 12/04		03.2123-2774.3	010803	ATE Ø 23,8
1.8 T	132	05/02→05/05		für Linkslenker; - ESP; → 12/04		24.2123-1709.3	010503	Ø 23,8
1.9 TDI	74 - 110	09/00→05/05						
1.9 TDI 4motion	74 - 110	09/00→05/05						
2.0 4motion	85	04/00→05/05						
2.3 V5	125	10/00→05/05						
2.3 V5 4motion	125	10/00→05/05						
1.6	74 - 75	05/99→05/05		→ 08/00; für Linkslenker; + ESP		03.2123-2024.3	010597	ATE Ø 23,8
	77	02/00→05/05		09/00→; + ESP; für Linkslenker; → 12/04		03.2123-2715.3	010802	ATE Ø 23,8
1.6 16V	92	05/99→05/05		09/00→; + ESP; für Rechtslenker; → 12/04		03.2123-2774.3	010803	ATE Ø 23,8
1.8 4motion	85	05/99→05/05						
2.0	150	05/99→05/05		für Linkslenker; - ESP; → 12/04		24.2123-1709.3	010503	Ø 23,8
2.8 V6 4motion	110	05/00→05/05		09/00→; + ESP; für Linkslenker; → 12/04		03.2123-2715.3	010802	ATE Ø 23,8
				09/00→; + ESP; für Rechtslenker; → 12/04		03.2123-2774.3	010803	ATE Ø 23,8
				09/00→; für Linkslenker; - ESP; → 12/04		24.2123-1709.3	010503	Ø 23,8
1.9 TDI	81 - 85	05/99→06/01		→ 08/00; für Linkslenker; + ESP		03.2123-2024.3	010597	ATE Ø 23,8
1.9 TDI 4motion	85	05/99→06/01		09/00→; für Linkslenker; + ESP		03.2123-2715.3	010802	ATE Ø 23,8
2.3 V5	110	05/99→10/00		09/00→; für Rechtslenker; + ESP		03.2123-2774.3	010803	ATE Ø 23,8
2.3 V5 4motion	110	05/99→10/00		für Linkslenker; - ESP		24.2123-1709.3	010503	Ø 23,8
1.9 TDI	96	11/00→05/05		04/01→; für Linkslenker; + ESP; → 12/04		03.2123-2715.3	010802	ATE Ø 23,8
1.9 TDI 4motion	96	11/00→05/05		04/01→; für Rechtslenker; + ESP; → 12/04		03.2123-2774.3	010803	ATE Ø 23,8
				04/01→; für Linkslenker; - ESP; → 12/04		24.2123-1709.3	010503	Ø 23,8
VW - CADDY II Großraumlimousine (9K9B) 11/95→12/04								
 Bremskraftverstärker								
1.4	44	11/95→06/03		für Linkslenker; - ABS		03.7750-6302.4	300161	ATE Ø 9" pneumatisch
1.4 16V	55	08/00→01/04		→ 9K-1-538270; für Linkslenker		10.6350-3902.4	300213	ATE Ø 9" pneumatisch
1.6	55	06/97→09/00						
1.7 SDI	42	07/96→09/00		9K-1-538271→; für Linkslenker		10.6350-4002.4	300285	ATE Ø 9" pneumatisch
1.9 D	47	11/95→01/04						
1.9 SDI	47	11/95→01/04						
1.9 TDI	66	10/96→01/04						
 Hauptbremszylinder								
1.4	44	11/95→06/03		für Linkslenker; - ABS		03.2122-1042.3	010137	Ø 22,2
1.4 16V	55	08/00→01/04		→ 9K-X-514000; für Rechtslenker; - ABS		03.2122-1042.3	010137	Ø 22,2
1.6	55	06/97→09/00						
1.9 D	47	11/95→01/04		für Linkslenker; + ABS		03.2123-1424.3	010637	ATE Ø 23,8
1.9 SDI	47	11/95→01/04		für Rechtslenker; + ABS		03.2123-1484.3	010595	ATE Ø 23,8
1.9 TDI	66	10/96→01/04						
1.7 SDI	42	07/96→09/00		für Linkslenker; - ABS		03.2122-1042.3	010137	Ø 22,2
				→ 9K-X-514000; für Rechtslenker; - ABS		03.2122-1042.3	010137	Ø 22,2
				für Linkslenker; + ABS		03.2123-1424.3	010637	ATE Ø 23,8
Verschlusschraube, Hauptbremszylinder								
1.4	44	11/95→06/03		für Linkslenker; - ABS		03.3517-0101.2	390322	
1.4 16V	55	08/00→01/04		→ 9K-X-514000; für Rechtslenker; - ABS		03.3517-0101.2	390322	
1.6	55	06/97→09/00						
1.7 SDI	42	07/96→09/00						
1.9 D	47	11/95→01/04						
1.9 SDI	47	11/95→01/04						
1.9 TDI	66	10/96→01/04						
VW - CADDY II Kasten/Großraumlimousine (9K9A) 11/95→01/04								
 Bremskraftverstärker								
1.4	55	08/00→01/04		für Linkslenker; - ABS		03.7750-6302.4	300161	ATE Ø 9" pneumatisch
1.7 SDI	42	07/96→09/00		→ 9K-1-538270; für Linkslenker		10.6350-3902.4	300213	ATE Ø 9" pneumatisch
1.9 D	47	11/95→01/04						
1.9 SDI	47	11/95→01/04		9K-1-538271→; für Linkslenker		10.6350-4002.4	300285	ATE Ø 9" pneumatisch
1.9 TDI	66	09/96→01/04						
60 1.4	44	11/95→01/04						
75 1.6	55	11/95→09/00						
 Hauptbremszylinder								
1.4	55	08/00→01/04		für Linkslenker; - ABS		03.2122-1042.3	010137	Ø 22,2
1.9 D	47	11/95→01/04		→ 9K-X-514000; für Rechtslenker; - ABS		03.2122-1042.3	010137	Ø 22,2
1.9 SDI	47	11/95→01/04						
1.9 TDI	66	09/96→01/04		für Linkslenker; + ABS		03.2123-1424.3	010637	ATE Ø 23,8
60 1.4	44	11/95→01/04						
→								













	kW					! #					
VW - CADDY II Kasten/Großraumlimousine (9K9A) 11/95→01/04											
 Hauptbremszylinder											
75 1.6	55	11/95→09/00		für Rechtslenker; + ABS		03.2123-1484.3 010595		ATE Ø 23,8			
1.7 SDI	42	07/96→09/00		für Linkslenker; - ABS		03.2122-1042.3 010137		Ø 22,2			
				→ 9K-X-514000; für Rechtslenker; - ABS		03.2122-1042.3 010137		Ø 22,2			
				für Linkslenker; + ABS		03.2123-1424.3 010637		ATE Ø 23,8			
Verschlusschraube, Hauptbremszylinder											
1.4	55	08/00→01/04		für Linkslenker; - ABS		03.3517-0101.2 390322					
1.7 SDI	42	07/96→09/00		→ 9K-X-514000; für Rechtslenker; - ABS		03.3517-0101.2 390322					
1.9 D	47	11/95→01/04									
1.9 SDI	47	11/95→01/04									
1.9 TDI	66	09/96→01/04									
60 1.4	44	11/95→01/04									
75 1.6	55	11/95→09/00									
VW - CADDY II Pick-up (9U7) 06/96→12/00											
 Hauptbremszylinder											
1.6	55	06/96→12/00		10/97→; - ABS		24.2122-1731.3 010656		Ø 22,2			
1.9 D	47	06/96→12/00									
 Bremskraftregler											
1.6	55	06/96→12/00		10/97→		03.6584-0107.3 320110		ATE lastabhängig 8/4 4x			
1.9 D	47	06/96→12/00									
VW - CADDY III Großraumlimousine (2KB, 2KJ, 2CB, 2CJ) 03/04→03/16											
 Bremskraftverstärker											
1.2 TSI	63 - 77	09/10→05/15		für Linkslenker		03.7873-4302.4 300312		ATE Ø 11" pneumatisch			
1.4	55 - 59	03/04→08/10									
1.6	75	04/04→05/15									
1.6 BiFuel	75	05/11→05/15									
1.6 TDI	55 - 75	08/10→05/15									
1.9 D	48	10/05→06/09									
1.9 TDI	55 - 77	04/04→08/10									
1.9 TDI 4motion	77	05/08→08/10									
2.0 EcoFuel	80	04/06→05/15									
2.0 SDI	51	03/04→08/10									
2.0 TDI	103 - 125	09/07→05/15									
2.0 TDI 16V	103	11/10→05/15									
2.0 TDI 16V 4motion	103	11/10→05/15									
2.0 TDI	81	08/10→05/15		10/10→; für Linkslenker							
2.0 TDI 4motion	81	08/10→05/15									
 Hauptbremszylinder											
1.2 TSI	63 - 77	09/10→05/15		für Linkslenker		03.2122-2129.3 010799		ATE Ø 22,2			
1.6 TDI	55 - 75	08/10→05/15		für Rechtslenker					24.4152-0132.3 011025		ATE Ø 22,2 ohne Bremsflüssigkeitsbehälter
2.0 TDI	125	05/12→05/15									
2.0 TDI 16V 4motion	103	11/10→05/15									
1.4	55 - 59	03/04→08/10		für Linkslenker		03.2122-2129.3 010799		ATE Ø 22,2			
1.6	75	04/04→05/15		→ 2K-6-150 000; für Rechtslenker					24.2122-1981.3 011024		ATE Ø 22,2 ohne Bremsflüssigkeitsbehälter
1.6 BiFuel	75	05/11→05/15									
1.9 D	48	10/05→06/09		2K-7-000 001→; für Rechtslenker					24.4152-0132.3 011025		ATE Ø 22,2 ohne Bremsflüssigkeitsbehälter
1.9 TDI	55 - 77	04/04→08/10									
1.9 TDI 4motion	77	05/08→08/10									
2.0 EcoFuel	80	04/06→05/15									
2.0 SDI	51	03/04→08/10									
2.0 TDI	103	09/07→08/10									
2.0 TDI 16V	103	11/10→05/15									
2.0 TDI	81	08/10→05/15		10/10→; für Linkslenker					03.2122-2129.3 010799		ATE Ø 22,2
2.0 TDI 4motion	81	08/10→05/15		10/10→; für Rechtslenker							
VW - CADDY III Kasten/Großraumlimousine (2KA, 2KH, 2CA, 2CH) 03/04→03/16											
 Bremskraftverstärker											
1.2 TSI	63 - 77	09/10→05/15		für Linkslenker					03.7873-4302.4 300312		ATE Ø 11" pneumatisch
1.4	55 - 59	03/04→08/10									
1.6	75	04/04→05/15									







	kW			 	! #		
VW - CADDY III Kasten/Großraumlimousine (2KA, 2KH, 2CA, 2CH) 03/04→03/16							
 Bremskraftverstärker							
1.6 BiFuel 1.6 TDI	75 55 - 75	05/11→05/15 08/10→05/15		für Linkslenker		03.7873-4302.4 300312	ATE Ø 11" pneumatisch
1.9 TDI	55 - 77	04/04→08/10					
1.9 TDI 4motion	77	11/08→08/10					
2.0 EcoFuel	80	04/06→05/15					
2.0 SDI	51	03/04→08/10					
2.0 TDI	62 - 125	09/07→05/15					
2.0 TDI 16V	103	11/10→05/15					
2.0 TDI 16V 4motion	103	11/10→05/15					
2.0 TDI 4motion	62	12/10→05/15					
2.0 TDI	81	08/10→05/15		10/10→; für Linkslenker		03.7873-4302.4 300312	ATE Ø 11" pneumatisch
2.0 TDI 4motion	81	08/10→05/15					
 Hauptbremszylinder							
1.2 TSI	63 - 77	09/10→05/15		für Linkslenker		03.2122-2129.3 010799	ATE Ø 22,2
1.6 TDI	55 - 75	08/10→05/15		für Rechtslenker		24.4152-0132.3 011025	ATE Ø 22,2 ohne Bremsflüssigkeitsbehälter
2.0 TDI	125	05/12→05/15					
2.0 TDI 4motion	62	12/10→05/15					
1.4	55 - 59	03/04→08/10		für Linkslenker		03.2122-2129.3 010799	ATE Ø 22,2
1.6	75	04/04→05/15		für Rechtslenker; → 2K-6-150 000		24.2122-1981.3 011024	ATE Ø 22,2 ohne Bremsflüssigkeitsbehälter
1.6 BiFuel	75	05/11→05/15					
1.9 TDI	55 - 77	04/04→08/10		2K-7-000 001→; für Rechtslenker		24.4152-0132.3 011025	ATE Ø 22,2 ohne Bremsflüssigkeitsbehälter
1.9 TDI 4motion	77	11/08→08/10					
2.0 EcoFuel	80	04/06→05/15					
2.0 SDI	51	03/04→08/10					
2.0 TDI	62 - 103	09/07→05/15					
2.0 TDI 16V	103	11/10→05/15					
2.0 TDI 16V 4motion	103	11/10→05/15					
2.0 TDI	81	08/10→05/15		10/10→; für Linkslenker		03.2122-2129.3 010799	ATE Ø 22,2
2.0 TDI 4motion	81	08/10→05/15		10/10→; für Rechtslenker		24.4152-0132.3 011025	ATE Ø 22,2 ohne Bremsflüssigkeitsbehälter
VW - CADDY IV Großraumlimousine (SAB, SAJ) 05/15→							
 Bremskraftverstärker							
1.0 TSI	62 - 75	11/15→09/20		für Rechtslenker		03.7848-9802.4 300344	ATE Ø 7 / 8" pneumatisch
1.2 TSI	62	06/15→09/20					
1.4 TGI CNG	81	06/15→09/20					
1.4 TSI	92 - 96	05/15→09/20					
1.6	81	11/15→09/20					
1.6 TDI	55 - 75	05/15→09/20					
2.0 TDI	55 - 110	05/15→09/20					
2.0 TDI 4motion	81 - 110	05/15→09/20					
ABT e-Caddy	83	04/20→					
 Hauptbremszylinder							
1.0 TSI	62 - 75	11/15→09/20		für Linkslenker		03.2123-3449.3 010808	ATE Ø 23,8
1.2 TSI	62	06/15→09/20		für Rechtslenker		24.4153-0202.3 011027	ATE Ø 23,8 ohne Bremsflüssigkeitsbehälter
1.4 TGI CNG	81	06/15→09/20					
1.4 TSI	92 - 96	05/15→09/20					
1.6	81	11/15→09/20					
1.6 TDI	55 - 75	05/15→09/20					
2.0 TDI	55 - 110	05/15→09/20					
2.0 TDI 4motion	81 - 110	05/15→09/20					
ABT e-Caddy	83	04/20→					
VW - CADDY IV Kasten/Großraumlimousine (SAA, SAH) 05/15→							
 Bremskraftverstärker							
1.0 TSI	75	11/15→09/20		für Rechtslenker		03.7848-9802.4 300344	ATE Ø 7 / 8" pneumatisch
1.2 TSI	62	06/15→09/20					
1.4 TGI CNG	81	06/15→09/20					
→							

	kW					! #		
VW - CADDY IV Kasten/Großraumlimousine (SAA, SAH) 05/15→								
 Bremskraftverstärker								
1.4 TSI	92 - 96	05/15→09/20		für Rechtslenker		03.7848-9802.4	300344	ATE Ø 7 / 8" pneumatisch
1.6	81	11/15→09/20						
1.6 TDI	55 - 75	05/15→09/20						
2.0 TDI	55 - 110	05/15→09/20						
2.0 TDI 4motion	55 - 110	05/15→09/20						
ABT e-Caddy	83	04/20→						
 Hauptbremszylinder								
1.0 TSI	75	11/15→09/20		für Linkslenker		03.2123-3449.3	010808	ATE Ø 23,8
1.2 TSI	62	06/15→09/20						
1.4 TGI CNG	81	06/15→09/20		für Rechtslenker		24.4153-0202.3	011027	ATE Ø 23,8 ohne Bremsflüssigkeitsbehälter
1.4 TSI	92 - 96	05/15→09/20						
1.6	81	11/15→09/20						
1.6 TDI	55 - 75	05/15→09/20						
2.0 TDI	55 - 110	05/15→09/20						
2.0 TDI 4motion	55 - 110	05/15→09/20						
ABT e-Caddy	83	04/20→						
VW - CADDY ALLTRACK Großraumlimousine (SAB) 05/15→								
 Bremskraftverstärker								
1.0 TSI	62 - 75	11/15→		für Rechtslenker		03.7848-9802.4	300344	ATE Ø 7 / 8" pneumatisch
1.2 TSI	62	06/15→						
1.4 TGI CNG	81	06/15→						
1.4 TSI	92 - 96	05/15→						
1.6 SRE	81	11/15→09/20						
1.6 TDI	55 - 75	05/15→						
2.0 TDI	55 - 110	05/15→						
2.0 TDI 4motion	90 - 110	05/15→						
2.0 TDI 4motion	81 - 103	05/15→		11/15→; für Rechtslenker		03.7848-9802.4	300344	ATE Ø 7 / 8" pneumatisch
 Hauptbremszylinder								
1.0 TSI	62 - 75	11/15→		für Linkslenker		03.2123-3449.3	010808	ATE Ø 23,8
1.2 TSI	62	06/15→						
1.4 TGI CNG	81	06/15→		für Rechtslenker		24.4153-0202.3	011027	ATE Ø 23,8 ohne Bremsflüssigkeitsbehälter
1.4 TSI	92 - 96	05/15→						
1.6 SRE	81	11/15→09/20						
1.6 TDI	55 - 75	05/15→						
2.0 TDI	55 - 110	05/15→						
2.0 TDI 4motion	81 - 110	05/15→						
VW - CADDY ALLTRACK Kasten/Großraumlimousine (SAA) 05/15→								
 Bremskraftverstärker								
1.0 TSI	75	11/15→		für Rechtslenker		03.7848-9802.4	300344	ATE Ø 7 / 8" pneumatisch
1.2 TSI	62	06/15→						
1.4 TGI CNG	81	06/15→						
1.4 TSI	92 - 96	05/15→						
1.6 SRE	81	11/15→09/20						
1.6 TDI	55 - 75	05/15→						
2.0 TDI	55 - 110	05/15→						
2.0 TDI 4motion	81 - 110	05/15→						
 Hauptbremszylinder								
1.0 TSI	75	11/15→		für Linkslenker		03.2123-3449.3	010808	ATE Ø 23,8
1.2 TSI	62	06/15→						
1.4 TGI CNG	81	06/15→		für Rechtslenker		24.4153-0202.3	011027	ATE Ø 23,8 ohne Bremsflüssigkeitsbehälter
→								











	kW					! #		
VW - CADDY ALLTRACK Kasten/Großraumlimousine (SAA) 05/15→								
 Hauptbremszylinder								
1.4 TSI	92 - 96	05/15→		für Linkslenker		03.2123-3449.3	010808	ATE Ø 23,8
1.6 SRE	81	11/15→09/20		für Rechtslenker		24.4153-0202.3	011027	ATE Ø 23,8 ohne Bremsflüssigkeitsbehälter
1.6 TDI	55 - 75	05/15→						
2.0 TDI	55 - 110	05/15→						
2.0 TDI 4motion	81 - 110	05/15→						
VW - CADDY Kasten/Großraumlimousine (6K9, 9E7, 9E9) 09/02→12/09								
 Bremskraftverstärker								
1.9 D	47	02/98→06/09		für Linkslenker		03.7873-4302.4	300312	ATE Ø 11" pneumatisch
 Hauptbremszylinder								
1.9 D	47	02/98→06/09		für Linkslenker		03.2122-2129.3	010799	ATE Ø 22,2
				für Rechtslenker; → 2K-6-150 000		24.2122-1981.3	011024	ATE Ø 22,2 ohne Bremsflüssigkeitsbehälter
				2K-7-000 001→; für Rechtslenker		24.4152-0132.3	011025	ATE Ø 22,2 ohne Bremsflüssigkeitsbehälter
VW - CALIFORNIA T5 Camper (7EC, 7EF, 7EG, 7HF, 7HC) 04/03→04/16								
 Bremskraftverstärker								
1.9 TDI	62 - 77	05/07→12/09		+PR 1AJ / 1AE / 1AC / 1AR; → 7H-A-050000		03.7765-1002.4	300246	ATE Ø 10 / 9" pneumatisch
2.0 TDI	62 - 132	09/09→08/15		+PR 1AK; → 7H-A-050000		03.7868-3702.4	300208	ATE Ø 10 / 8" pneumatisch
2.0 TDI 4motion	103 - 132	10/09→08/15						
2.5 TDi	120	05/07→11/09						
2.5 TDI	96 - 128	05/07→11/09						
2.5 TDI 4motion	96 - 128	05/07→11/09						
Pedalwegsensor, Bremspedal								
1.9 TDI	62 - 77	05/07→12/09		+PR 1AT; → 7H-A-050000		03.0655-0006.2	370006	ATE
2.0 TDI	62 - 132	09/09→08/15						
2.0 TDI 4motion	103 - 132	10/09→08/15						
2.5 TDi	120	05/07→11/09						
2.5 TDI	96 - 128	05/07→11/09						
2.5 TDI 4motion	96 - 128	05/07→11/09						
 Hauptbremszylinder								
1.9 TDI	62 - 77	05/07→12/09		→ 7H-A-050000		03.2126-3014.3	010811	ATE Ø 27
				7H-6-000001→ 7H-6-200000; für Rechtslenker; +PR 1AT		03.2126-3014.3	010811	ATE Ø 27
				7H-A-200001→		03.2126-3144.3	010941	ATE Ø 27
2.0 TDI	62 - 132	09/09→08/15		→ 7H-A-050000		03.2126-3014.3	010811	ATE Ø 27
2.0 TDI 4motion	100 - 132	10/09→08/15		7H-A-200001→		03.2126-3144.3	010941	ATE Ø 27
2.5 TDi	120	05/07→11/09						
2.5 TDI	96 - 128	05/07→11/09						
2.5 TDI 4motion	96 - 128	05/07→11/09						
2.0 TDI	84	05/11→08/15				03.2126-3144.3	010941	ATE Ø 27
2.0 TSI	110 - 150	05/11→08/15						
2.0 TSI 4motion	150	07/11→08/15						
VW - CC B7 (358) 11/11→10/17								
 Bremskraftverstärker								
1.4 TSI	110 - 118	11/11→12/16		für Rechtslenker; +PR 1ZM		03.7848-9802.4	300344	ATE Ø 7 / 8" pneumatisch
1.4 TSI MultiFuel	118	11/11→12/16		+PR 1ZG; für Linkslenker		03.7873-4402.4	300292	ATE Ø 11" pneumatisch
1.8 TSI	112 - 118	11/11→12/16		+PR 1LA / 1LB / 1ZM; für Linkslenker		03.7873-4502.4	300284	ATE Ø 11" pneumatisch
2.0 TDI	100 - 135	11/11→12/16						
→								













	kw					! #		
VW - CC B7 (358) 11/11→10/17								
 Bremskraftverstärker								
2.0 TDI 4motion	103 - 130	11/11→12/16		für Rechtslenker; +PR 1ZM		03.7848-9802.4	300344	ATE Ø 7 / 8" pneumatisch
2.0 TFSI	147	11/11→12/16		+PR 1ZG; für Linkslenker		03.7873-4402.4	300292	ATE Ø 11" pneumatisch
2.0 TSI	155	11/11→12/16		+PR 1LA / 1LB / 1ZM; für Linkslenker		03.7873-4502.4	300284	ATE Ø 11" pneumatisch
3.6 FSI 4motion	220	11/11→12/16						
 Hauptbremszylinder								
1.4 TSI	110 - 118	11/11→12/16		für Linkslenker; +PR 1ZG		03.4152-0116.3	010814	ATE Ø 22,2
1.4 TSI MultiFuel	118	11/11→12/16		für Linkslenker; +PR 1LA / 1LB / 1ZM		03.4153-0186.3	010816	ATE Ø 23,8
1.8 TSI	112 - 118	11/11→12/16		für Rechtslenker; +PR 1LA / 1LB / 1ZM		24.4153-0192.3	011026	ATE Ø 23,8 ohne Bremsflüssigkeitsbehälter
2.0 TDI	100 - 135	11/11→12/16						
2.0 TDI 4motion	103 - 130	11/11→12/16						
2.0 TFSI	147	11/11→12/16						
2.0 TSI	155	11/11→12/16						
3.6 FSI 4motion	220	11/11→12/16						
Drucksensor, Bremskraftverstärker								
3.6 FSI 4motion	220	11/11→12/16		+PR 1ZG; für Rechtslenker		03.0655-0101.2	370008	ATE
VW - CRAFTER 30-35 Bus (2E_) 04/06→12/16								
 Hauptbremszylinder								
2.0 TDI	80 - 100	05/11→12/16		07/11→		24.2126-1704.3	010990	TRW Ø 27
						24.2126-1708.3	011128	Ø 27 ohne Bremsflüssigkeitsbehälter
2.0 TDI	84 - 120	07/11→12/16				24.2126-1704.3	010990	TRW Ø 27
2.0 TDI 4motion	120	11/11→12/16				24.2126-1708.3	011128	Ø 27 ohne Bremsflüssigkeitsbehälter
2.5 TDI	65 - 120	04/06→05/13		→ 06/11; +PR 0WC / 0WL / 5EV / 5EX		24.2125-1750.3	011050	Ø 25,4 ohne Bremsflüssigkeitsbehälter
				07/11→		24.2126-1704.3	010990	TRW Ø 27
						24.2126-1708.3	011128	Ø 27 ohne Bremsflüssigkeitsbehälter
VW - CRAFTER 30-50 Kasten (2E_) 04/06→12/16								
 Hauptbremszylinder								
2.0 TDI	80 - 100	05/11→12/16		07/11→		24.2126-1704.3	010990	TRW Ø 27
						24.2126-1708.3	011128	Ø 27 ohne Bremsflüssigkeitsbehälter
2.0 TDI	84 - 120	07/11→12/16				24.2126-1704.3	010990	TRW Ø 27
						24.2126-1708.3	011128	Ø 27 ohne Bremsflüssigkeitsbehälter
2.0 TDI 4motion	120	07/11→12/16		11/11→		24.2126-1704.3	010990	TRW Ø 27
						24.2126-1708.3	011128	Ø 27 ohne Bremsflüssigkeitsbehälter
2.5 TDI	65 - 120	04/06→05/13		→ 06/11; +PR 0WC / 0WL / 5EV / 5EX		24.2125-1750.3	011050	Ø 25,4 ohne Bremsflüssigkeitsbehälter
				07/11→		24.2126-1704.3	010990	TRW Ø 27
						24.2126-1708.3	011128	Ø 27 ohne Bremsflüssigkeitsbehälter
VW - CRAFTER 30-50 Pritsche/Fahrgestell (2F_) 04/06→12/16								
 Hauptbremszylinder								
2.0 TDI	80 - 100	05/11→12/16		07/11→		24.2126-1704.3	010990	TRW Ø 27
						24.2126-1708.3	011128	Ø 27 ohne Bremsflüssigkeitsbehälter
2.0 TDI	84 - 120	07/11→12/16				24.2126-1704.3	010990	TRW Ø 27
2.0 TDI 4motion	120	11/11→12/16				24.2126-1708.3	011128	Ø 27 ohne Bremsflüssigkeitsbehälter
2.5 TDI	65 - 120	04/06→05/13		→ 06/11; +PR 0WC / 0WL / 5EV / 5EX		24.2125-1750.3	011050	Ø 25,4 ohne Bremsflüssigkeitsbehälter
				07/11→		24.2126-1704.3	010990	TRW Ø 27
						24.2126-1708.3	011128	Ø 27 ohne Bremsflüssigkeitsbehälter







	kw			 	! #		
VW - EOS (1F7, 1F8) 03/06→08/15							
 Bremskraftverstärker							
1.4 TSI	90 - 118	11/07→08/15		für Rechtslenker; +PR 1ZA / 1LJ	03.7848-9802.4	300344	ATE Ø 7 / 8" pneumatisch
1.6 FSI	85	06/06→05/08		für Linkslenker	03.7863-3332.4	300308	ATE Ø 10" pneumatisch
2.0 TDI	100 - 103	06/06→08/15					
2.0 TDI 16V	103	05/08→08/15					
2.0 FSI	110	03/06→05/08		05/06→; +PR 1ZA / 1LJ; für Rechtslenker	03.7848-9802.4	300344	ATE Ø 7 / 8" pneumatisch
2.0 TFSI	147	03/06→08/15		05/06→; für Linkslenker; +PR 1ZD	03.7863-3232.4	300307	ATE Ø 10" pneumatisch
				05/06→; für Linkslenker; +PR 1ZA / 1ZE / 1LJ	03.7863-3332.4	300308	ATE Ø 10" pneumatisch
2.0 TSI	155	11/09→08/15		für Rechtslenker; +PR 1ZA / 1LJ	03.7848-9802.4	300344	ATE Ø 7 / 8" pneumatisch
3.2 V6	184	06/06→05/09		für Linkslenker; +PR 1ZD	03.7863-3232.4	300307	ATE Ø 10" pneumatisch
				für Linkslenker; +PR 1ZA / 1ZE / 1LJ	03.7863-3332.4	300308	ATE Ø 10" pneumatisch
3.6 V6	191	05/09→11/10		für Rechtslenker; +PR 1ZA / 1LJ	03.7848-9802.4	300344	ATE Ø 7 / 8" pneumatisch
				für Linkslenker; +PR 1ZD	03.7863-3232.4	300307	ATE Ø 10" pneumatisch
				+PR 1LK; für Linkslenker	03.7863-3332.4	300308	ATE Ø 10" pneumatisch
 Hauptbremszylinder							
1.4 TSI	90 - 118	11/07→08/15		für Linkslenker; +PR 1AT / 1ZD	03.2122-2129.3	010799	ATE Ø 22,2
1.6 FSI	85	06/06→05/08		für Linkslenker; +PR 1ZA / 1ZE / 1LJ / 1LK	03.2123-3449.3	010808	ATE Ø 23,8
2.0 TDI	100 - 103	06/06→08/15		für Rechtslenker; +PR 1ZD	24.4152-0132.3	011025	ATE Ø 22,2 ohne Bremsflüssigkeitsbehälter
2.0 TDI 16V	103	05/08→08/15					
2.0 TSI	155	11/09→08/15		für Rechtslenker; +PR 1ZA / 1ZE / 1LJ	24.4153-0202.3	011027	ATE Ø 23,8 ohne Bremsflüssigkeitsbehälter
3.2 V6	184	06/06→05/09					
3.6 V6	191	05/09→11/10					
2.0 FSI	110	03/06→05/08		05/06→; für Linkslenker; +PR 1AT / 1ZD	03.2122-2129.3	010799	ATE Ø 22,2
2.0 TFSI	147	03/06→08/15		05/06→; für Linkslenker; +PR 1ZA / 1ZE / 1LJ / 1LK	03.2123-3449.3	010808	ATE Ø 23,8
				05/06→; für Rechtslenker; +PR 1ZD	24.4152-0132.3	011025	ATE Ø 22,2 ohne Bremsflüssigkeitsbehälter
				05/06→; für Rechtslenker; +PR 1ZA / 1ZE / 1LJ	24.4153-0202.3	011027	ATE Ø 23,8 ohne Bremsflüssigkeitsbehälter
VW - FOX Schrägheck (5Z1, 5Z3, 5Z4) 08/03→10/15							
 Hauptbremszylinder							
1.2	40	04/05→07/11		+PR 1ZF / 1AC / 1AT; + ABS	24.2120-1734.3	010702	Ø 20,6
1.4	55	04/05→12/09					
1.4 TDI	51	04/05→12/09		+PR 1ZN; + ABS	24.2120-1734.3	010702	Ø 20,6
1.2	44	09/10→12/11		→ 08/11; +PR 1ZF / 1AC / 1AT; + ABS	24.2120-1734.3	010702	Ø 20,6
1.6	74	10/03→08/14					
1.6 Total Flex	74	10/03→08/14		→ 08/11; +PR 1ZN; + ABS	24.2120-1734.3	010702	Ø 20,6
VW - FOX Van (5Z1) 09/10→12/11							
 Hauptbremszylinder							
1.2	44	09/10→12/11		→ 08/11; +PR 1ZF / 1AC / 1AT; + ABS	24.2120-1734.3	010702	Ø 20,6
				→ 08/11; +PR 1ZN; + ABS	24.2120-1734.3	010702	Ø 20,6
VW - GOLF IV (1J1) 08/97→04/08							
 Bremskraftverstärker							
1.4 16V	55	10/97→05/04		09/00→ 10/01; für Linkslenker; +PR 1AT	03.7860-0602.4	300141	ATE Ø 10" pneumatisch
1.6	75	08/00→06/05		→ 08/00; für Linkslenker; +PR 1AT	03.7863-0402.4	300124	ATE Ø 10" pneumatisch
1.6 16V	77	02/00→06/05		11/01→ 10/03; für Linkslenker; +PR 1AT	03.7863-3502.4	300128	ATE Ø 10" pneumatisch
1.6	74	08/97→05/04		09/00→ 10/01; für Linkslenker; +PR 1AT	03.7860-0602.4	300141	ATE Ø 10" pneumatisch
1.8	92	08/97→06/05		10/97→ 08/00; für Linkslenker; +PR 1AT	03.7863-0402.4	300124	ATE Ø 10" pneumatisch
1.9 SDI	50	08/97→06/05					
1.9 TDI	81	08/97→05/04		11/01→ 10/03; für Linkslenker; +PR 1AT	03.7863-3502.4	300128	ATE Ø 10" pneumatisch
1.6	74	02/01→03/07		für Linkslenker; +PR 1AT	03.7863-3502.4	300128	ATE Ø 10" pneumatisch
2.0 BiFuel	85	05/02→05/03					
1.6 FSI	81	01/02→06/05		→ 10/03; für Linkslenker; +PR 1AT	03.7863-3502.4	300128	ATE Ø 10" pneumatisch
3.2 R32 4motion	177	09/02→06/05					
1.8 4motion	92	05/98→06/05		09/00→ 10/01; für Linkslenker; +PR 1AT	03.7860-0602.4	300141	ATE Ø 10" pneumatisch
				07/98→ 08/00; für Linkslenker; +PR 1AT	03.7863-0402.4	300124	ATE Ø 10" pneumatisch
				11/01→ 10/03; für Linkslenker; +PR 1AT	03.7863-3502.4	300128	ATE Ø 10" pneumatisch
1.8 T	110	08/97→06/05		09/00→; für Linkslenker; +PR 1AT	03.7860-0602.4	300141	ATE Ø 10" pneumatisch
2.3 V5	110	08/97→10/00		10/97→ 08/00; für Linkslenker; +PR 1AT	03.7863-0402.4	300124	ATE Ø 10" pneumatisch
1.8 T GTI	132	08/01→06/05		→ 10/01; für Linkslenker; +PR 1AT	03.7860-0602.4	300141	ATE Ø 10" pneumatisch
2.0 4motion	85	10/00→06/05		11/01→ 10/03; für Linkslenker; +PR 1AT	03.7863-3502.4	300128	ATE Ø 10" pneumatisch
→							







	kw			 	! #		
VW - GOLF IV (1J1) 08/97→04/08							
Bremskraftverstärker							
1.9 TDI 1.9 TDI 4motion	66 66	10/97→05/04 07/98→04/02		09/00→ 06/01; für Linkslenker; +PR 1AT → 08/00; für Linkslenker; +PR 1AT	03.7860-0602.4 300141 03.7863-0402.4 300124	ATE Ø 10" pneumatisch ATE Ø 10" pneumatisch	
1.9 TDI 1.9 TDI 4motion	74 74	09/00→06/05 09/00→06/05		→ 10/01; für Linkslenker; +PR 1AT 11/01→; für Linkslenker; +PR 1AT	03.7860-0602.4 300141 03.7863-3502.4 300128	ATE Ø 10" pneumatisch ATE Ø 10" pneumatisch	
1.9 TDI	85	12/98→06/01		09/00→; für Linkslenker; +PR 1AT 05/99→ 08/00; für Linkslenker; +PR 1AT	03.7860-0602.4 300141 03.7863-0402.4 300124	ATE Ø 10" pneumatisch ATE Ø 10" pneumatisch	
1.9 TDI 1.9 TDI 4motion	96 96	11/00→06/05 11/00→06/05		04/01→ 10/01; für Linkslenker; +PR 1AT 11/01→ 10/03; für Linkslenker; +PR 1AT	03.7860-0602.4 300141 03.7863-3502.4 300128	ATE Ø 10" pneumatisch ATE Ø 10" pneumatisch	
1.9 TDI 1.9 TDI 4motion	110 110	05/00→06/05 02/00→06/05		09/00→ 10/01; für Linkslenker; +PR 1AT 11/01→ 10/03; für Linkslenker; +PR 1AT	03.7860-0602.4 300141 03.7863-3502.4 300128	ATE Ø 10" pneumatisch ATE Ø 10" pneumatisch	
1.9 TDI 4motion	85	09/99→06/01		09/00→; für Linkslenker; +PR 1AT 11/99→ 08/00; für Linkslenker; +PR 1AT	03.7860-0602.4 300141 03.7863-0402.4 300124	ATE Ø 10" pneumatisch ATE Ø 10" pneumatisch	
2.0	85	07/98→05/04		09/00→ 10/01; für Linkslenker; +PR 1AT 08/98→ 08/00; für Linkslenker; +PR 1AT 11/01→ 10/03; für Linkslenker; +PR 1AT	03.7860-0602.4 300141 03.7863-0402.4 300124 03.7863-3502.4 300128	ATE Ø 10" pneumatisch ATE Ø 10" pneumatisch ATE Ø 10" pneumatisch	
2.3 V5 2.3 V5 4motion	125 125	10/00→06/05 10/00→06/05		→ 10/03; für Linkslenker; +PR 1AT 11/01→ 10/03; für Linkslenker; +PR 1AT	03.7860-0602.4 300141 03.7863-3502.4 300128	ATE Ø 10" pneumatisch ATE Ø 10" pneumatisch	
2.3 V5 4motion	110	12/98→10/00		09/00→; für Linkslenker; +PR 1AT → 08/00; für Linkslenker; +PR 1AT	03.7860-0602.4 300141 03.7863-0402.4 300124	ATE Ø 10" pneumatisch ATE Ø 10" pneumatisch	
2.8 VR6	147	03/02→06/05		für Linkslenker; +PR 1AT	03.7860-0602.4 300141 03.7863-3502.4 300128	ATE Ø 10" pneumatisch ATE Ø 10" pneumatisch	
2.8 VR6 4motion	150	03/99→06/05		09/00→ 10/03; für Linkslenker; +PR 1AT → 08/00; für Linkslenker; +PR 1AT 11/01→ 10/03; für Linkslenker; +PR 1AT	03.7860-0602.4 300141 03.7863-0402.4 300124 03.7863-3502.4 300128	ATE Ø 10" pneumatisch ATE Ø 10" pneumatisch ATE Ø 10" pneumatisch	
Hauptbremszylinder							
1.4 16V 1.6 1.6 16V 2.8 VR6 4motion	55 75 77 150	10/97→05/04 08/00→06/05 02/00→06/05 03/99→06/05		→ 08/00; für Linkslenker; +PR 1AT 09/00→ 10/03; für Linkslenker; +PR 1AT 09/00→ 10/03; für Rechtslenker; +PR 1AT → 10/03; für Linkslenker; +PR 1AM / 1AC / 1AH / 1AJ	03.2123-2024.3 010597 03.2123-2715.3 010802 03.2123-2774.3 010803 24.2123-1709.3 010503	ATE Ø 23,8 ATE Ø 23,8 ATE Ø 23,8 Ø 23,8	
1.6 1.8 1.9 SDI 1.9 TDI	74 92 50 81	08/97→05/04 08/97→06/05 08/97→06/05 08/97→05/04		10/97→ 08/00; für Linkslenker; +PR 1AT 09/00→ 10/03; für Linkslenker; +PR 1AT 09/00→ 10/03; für Rechtslenker; +PR 1AT 10/97→ 10/03; für Linkslenker; +PR 1AM / 1AC / 1AH / 1AJ	03.2123-2024.3 010597 03.2123-2715.3 010802 03.2123-2774.3 010803 24.2123-1709.3 010503	ATE Ø 23,8 ATE Ø 23,8 ATE Ø 23,8 Ø 23,8	
1.6 1.9 TDI 1.9 TDI 4motion 2.0 BiFuel 2.8 VR6	74 74 74 85 147	02/01→03/07 09/00→06/05 09/00→06/05 05/02→05/03 03/02→06/05		für Linkslenker; +PR 1AT für Rechtslenker; +PR 1AT für Linkslenker; +PR 1AM / 1AC / 1AH / 1AJ	03.2123-2715.3 010802 03.2123-2774.3 010803 24.2123-1709.3 010503	ATE Ø 23,8 ATE Ø 23,8 Ø 23,8	
1.6 FSI 1.8 T GTI 2.0 4motion 2.3 V5 2.3 V5 4motion 3.2 R32 4motion	81 132 85 125 125 177	01/02→06/05 08/01→06/05 10/00→06/05 10/00→06/05 10/00→06/05 09/02→06/05		→ 10/03; für Linkslenker; +PR 1AT → 10/03; für Rechtslenker; +PR 1AT → 10/03; für Linkslenker; +PR 1AM / 1AC / 1AH / 1AJ	03.2123-2715.3 010802 03.2123-2774.3 010803 24.2123-1709.3 010503	ATE Ø 23,8 ATE Ø 23,8 Ø 23,8	
1.8 4motion	92	05/98→06/05		07/98→ 08/00; für Linkslenker; +PR 1AT 09/00→ 10/03; für Linkslenker; +PR 1AT 09/00→ 10/03; für Rechtslenker; +PR 1AT 07/98→ 10/03; für Linkslenker; +PR 1AM / 1AC / 1AH / 1AJ	03.2123-2024.3 010597 03.2123-2715.3 010802 03.2123-2774.3 010803 24.2123-1709.3 010503	ATE Ø 23,8 ATE Ø 23,8 ATE Ø 23,8 Ø 23,8	
1.8 T 2.3 V5	110 110	08/97→06/05 08/97→10/00		10/97→ 08/00; für Linkslenker; +PR 1AT 09/00→; für Linkslenker; +PR 1AT 09/00→; für Rechtslenker; +PR 1AT 10/97→; für Linkslenker; +PR 1AM / 1AC / 1AH / 1AJ	03.2123-2024.3 010597 03.2123-2715.3 010802 03.2123-2774.3 010803 24.2123-1709.3 010503	ATE Ø 23,8 ATE Ø 23,8 ATE Ø 23,8 Ø 23,8	
1.9 TDI	66	10/97→05/04		→ 08/00; für Linkslenker; +PR 1AT 09/00→ 04/02; für Linkslenker; +PR 1AT 09/00→ 06/01; für Rechtslenker; +PR 1AT → 06/01; für Linkslenker; +PR 1AM / 1AC / 1AH / 1AJ	03.2123-2024.3 010597 03.2123-2715.3 010802 03.2123-2774.3 010803 24.2123-1709.3 010503	ATE Ø 23,8 ATE Ø 23,8 ATE Ø 23,8 Ø 23,8	
1.9 TDI →	85	12/98→06/01		05/99→ 08/00; für Linkslenker; +PR 1AT	03.2123-2024.3 010597	ATE Ø 23,8	









	kw					! #		
VW - GOLF IV (1J1) 08/97→04/08								
 Hauptbremszylinder								
1.9 TDI	85	12/98→06/01		09/00→; für Linkslenker; +PR 1AT	03.2123-2715.3	010802	ATE Ø 23,8	
				09/00→; für Rechtslenker; +PR 1AT	03.2123-2774.3	010803	ATE Ø 23,8	
				05/99→; für Linkslenker; +PR 1AM / 1AC / 1AH / 1AJ	24.2123-1709.3	010503	Ø 23,8	
1.9 TDI 1.9 TDI 4motion	96 96	11/00→06/05 11/00→06/05		04/01→ 10/03; für Linkslenker; +PR 1AT	03.2123-2715.3	010802	ATE Ø 23,8	
				04/01→ 10/03; für Rechtslenker; +PR 1AT	03.2123-2774.3	010803	ATE Ø 23,8	
				04/01→ 10/03; für Linkslenker; +PR 1AM / 1AC / 1AH / 1AJ	24.2123-1709.3	010503	Ø 23,8	
1.9 TDI 1.9 TDI 4motion	110 110	05/00→06/05 02/00→06/05		09/00→ 10/03; für Linkslenker; +PR 1AT	03.2123-2715.3	010802	ATE Ø 23,8	
				09/00→ 10/03; für Rechtslenker; +PR 1AT	03.2123-2774.3	010803	ATE Ø 23,8	
				09/00→ 10/03; für Linkslenker; +PR 1AM / 1AC / 1AH / 1AJ	24.2123-1709.3	010503	Ø 23,8	
1.9 TDI 4motion	66	07/98→04/02		→ 08/00; für Linkslenker; +PR 1AT	03.2123-2024.3	010597	ATE Ø 23,8	
				09/00→ 06/01; für Linkslenker; +PR 1AT	03.2123-2715.3	010802	ATE Ø 23,8	
				09/00→ 06/01; für Rechtslenker; +PR 1AT	03.2123-2774.3	010803	ATE Ø 23,8	
				→ 06/01; für Linkslenker; +PR 1AM / 1AC / 1AH / 1AJ	24.2123-1709.3	010503	Ø 23,8	
1.9 TDI 4motion	85	09/99→06/01		11/99→ 08/00; für Linkslenker; +PR 1AT	03.2123-2024.3	010597	ATE Ø 23,8	
				09/00→; für Linkslenker; +PR 1AT	03.2123-2715.3	010802	ATE Ø 23,8	
				09/00→; für Rechtslenker; +PR 1AT	03.2123-2774.3	010803	ATE Ø 23,8	
				11/99→; für Linkslenker; +PR 1AM / 1AC / 1AH / 1AJ	24.2123-1709.3	010503	Ø 23,8	
2.0	85	07/98→05/04		08/98→ 08/00; für Linkslenker; +PR 1AT	03.2123-2024.3	010597	ATE Ø 23,8	
				09/00→ 10/03; für Linkslenker; +PR 1AT	03.2123-2715.3	010802	ATE Ø 23,8	
				09/00→ 10/03; für Rechtslenker; +PR 1AT	03.2123-2774.3	010803	ATE Ø 23,8	
				08/98→ 10/03; für Linkslenker; +PR 1AM / 1AC / 1AH / 1AJ	24.2123-1709.3	010503	Ø 23,8	
2.3 V5 4motion	110	12/98→10/00		→ 08/00; für Linkslenker; +PR 1AT	03.2123-2024.3	010597	ATE Ø 23,8	
				09/00→; für Linkslenker; +PR 1AT	03.2123-2715.3	010802	ATE Ø 23,8	
				09/00→; für Rechtslenker; +PR 1AT	03.2123-2774.3	010803	ATE Ø 23,8	
				für Linkslenker; +PR 1AM / 1AC / 1AH / 1AJ	24.2123-1709.3	010503	Ø 23,8	
VW - GOLF IV (9B3) 03/06→								
 Bremskraftverstärker								
1.6 1.6 Total Flex 1.8 GTI 2.0	74 74 - 77 132 85	03/07→12/10 03/07→06/14 01/07→12/10 01/07→12/10		10/08→; +PR 1ZA / 1ZB / 1ZE / 1LJ; für Rechtslenker	03.7848-9802.4	300344	ATE Ø 7 / 8" pneumatisch	
				1K-9-400001→; → 11/10; +PR 1ZK; für Linkslenker	03.7860-8802.4	300291	ATE Ø 10" pneumatisch	
				+PR 1ZD / 1ZF / 1ZP / 1LV; für Linkslenker	03.7863-3232.4	300307	ATE Ø 10" pneumatisch	
				→ 1K-9-200000; +PR 1LJ / 1LL / 1LM; für Linkslenker	03.7863-3332.4	300308	ATE Ø 10" pneumatisch	
				1K-9-400001→; → 11/10; +PR 1ZA / 1ZB / 1ZE / 1LJ; für Linkslenker	03.7863-3332.4	300308	ATE Ø 10" pneumatisch	
1.8 GTI	142	04/07→12/09		10/08→; +PR 1ZA / 1ZB / 1ZE / 1LJ; für Rechtslenker	03.7848-9802.4	300344	ATE Ø 7 / 8" pneumatisch	
				1K-9-400001→; +PR 1ZK; für Linkslenker	03.7860-8802.4	300291	ATE Ø 10" pneumatisch	
				+PR 1ZD / 1ZF / 1ZP / 1LV; für Linkslenker	03.7863-3232.4	300307	ATE Ø 10" pneumatisch	
				→ 1K-9-200000; +PR 1LJ / 1LL / 1LM; für Linkslenker	03.7863-3332.4	300308	ATE Ø 10" pneumatisch	
				1K-9-400001→; +PR 1ZA / 1ZB / 1ZE / 1LJ; für Linkslenker	03.7863-3332.4	300308	ATE Ø 10" pneumatisch	
 Hauptbremszylinder								
1.6 1.6 Total Flex	74 74 -	03/07→12/10 03/07→06/14		+PR 1ZD / 1ZF / 1ZP / 1LV; für Linkslenker	03.2122-2129.3	010799	ATE Ø 22,2	
				+PR 1ZA / 1ZB / 1ZE / 1LJ; für Linkslenker	03.2123-3449.3	010808	ATE Ø 23,8	
1.8 GTI 2.0	132 - 142 85	01/07→12/10 01/07→12/10		+PR 1ZD / 1ZF / 1ZP / 1LV; für Rechtslenker	24.4152-0132.3	011025	ATE Ø 22,2 ohne Bremsflüssigkeitsbehälter	
				+PR 1ZA / 1ZB / 1ZE / 1LJ; für Rechtslenker	24.4153-0202.3	011027	ATE Ø 23,8 ohne Bremsflüssigkeitsbehälter	







	kw					! #		
VW - GOLF IV Cabriolet (1E7) 06/98→12/02								
 Bremskraftverstärker								
1.6	74	06/98→06/02			für Linkslenker; - ABS; → 02/02	03.7750-5502.4	300081	ATE Ø 9" pneumatisch
1.8	55 - 66	06/98→06/02			1E-S-021847→; für Linkslenker; + ABS; → 02/02	10.6360-2002.4	300143	ATE Ø 10" pneumatisch
1.9 TDI	66	06/98→06/02						
2.0	85	06/98→06/02						
1.9 TDI	81	06/98→06/02			für Linkslenker; - ABS; → 02/02	03.7750-5502.4	300081	ATE Ø 9" pneumatisch
					für Linkslenker; + ABS; → 02/02	10.6360-2002.4	300143	ATE Ø 10" pneumatisch
 Hauptbremszylinder								
1.6	74	06/98→06/02			- ABS; → 02/02	03.2122-1042.3	010137	Ø 22,2
1.8	55 - 66	06/98→06/02			1E-S-021847→; für Linkslenker; + ABS; → 02/02	03.2123-1424.3	010637	ATE Ø 23,8
1.9 TDI	66	06/98→06/02						
2.0	85	06/98→06/02			1E-S-021847→; für Rechtslenker; + ABS; → 02/02	03.2123-1484.3	010595	ATE Ø 23,8
					→ 1E-S-021846; für Linkslenker; + ABS	10.6123-0674.3	010639	ATE Ø 23,8
1.9 TDI	81	06/98→06/02			- ABS; → 02/02	03.2122-1042.3	010137	Ø 22,2
					für Linkslenker; + ABS; → 02/02	03.2123-1424.3	010637	ATE Ø 23,8
					für Rechtslenker; + ABS; → 02/02	03.2123-1484.3	010595	ATE Ø 23,8
Verschlusschraube, Hauptbremszylinder								
1.6	74	06/98→06/02			- ABS; → 02/02	03.3517-0101.2	390322	
1.8	55 - 66	06/98→06/02						
1.9 TDI	66 - 81	06/98→06/02						
2.0	85	06/98→06/02						
 Bremskraftregler								
1.6	74	06/98→06/02			→ 02/02	03.6584-0107.3	320110	ATE lastabhängig 8/4 4x
1.8	55 - 66	06/98→06/02						
1.9 TDI	66	06/98→06/02						
2.0	85	06/98→06/02						
VW - GOLF IV Van (1J1) 10/97→05/04								
 Bremskraftverstärker								
1.9 SDI	50	11/98→05/04			09/00→ 06/01; für Linkslenker; +PR 1AT	03.7860-0602.4	300141	ATE Ø 10" pneumatisch
1.9 TDI	66 - 81	10/97→05/04			→ 08/00; für Linkslenker; +PR 1AT	03.7863-0402.4	300124	ATE Ø 10" pneumatisch
1.9 TDI	96	04/01→05/04			→ 06/01; für Linkslenker; +PR 1AT	03.7860-0602.4	300141	ATE Ø 10" pneumatisch
					→ 10/01; für Linkslenker; +PR 1AT	03.7860-0602.4	300141	ATE Ø 10" pneumatisch
					11/01→ 10/03; für Linkslenker; +PR 1AT	03.7863-3502.4	300128	ATE Ø 10" pneumatisch
1.9 TDI 4motion	85	01/00→04/01			für Linkslenker; +PR 1AT; 09/00→	03.7860-0602.4	300141	ATE Ø 10" pneumatisch
					→ 08/00; für Linkslenker; +PR 1AT	03.7863-0402.4	300124	ATE Ø 10" pneumatisch
 Hauptbremszylinder								
1.9 SDI	50	11/98→05/04			→ 08/00; für Linkslenker; +PR 1AT	03.2123-2024.3	010597	ATE Ø 23,8
1.9 TDI	66 - 81	10/97→05/04			09/00→ 04/02; für Linkslenker; +PR 1AT	03.2123-2715.3	010802	ATE Ø 23,8
					09/00→ 06/01; für Rechtslenker; +PR 1AT	03.2123-2774.3	010803	ATE Ø 23,8
					→ 06/01; für Linkslenker; +PR 1AM / 1AC / 1AH / 1AJ	24.2123-1709.3	010503	Ø 23,8
1.9 TDI	96	04/01→05/04			→ 04/02; für Linkslenker; +PR 1AT	03.2123-2715.3	010802	ATE Ø 23,8
					→ 10/03; für Linkslenker; +PR 1AT	03.2123-2715.3	010802	ATE Ø 23,8
					→ 10/03; für Rechtslenker; +PR 1AT	03.2123-2774.3	010803	ATE Ø 23,8
					→ 06/01; für Rechtslenker; +PR 1AT	03.2123-2774.3	010803	ATE Ø 23,8
					→ 10/03; für Linkslenker; +PR 1AM / 1AC / 1AH / 1AJ	24.2123-1709.3	010503	Ø 23,8
					→ 06/01; für Linkslenker; +PR 1AM / 1AC / 1AH / 1AJ	24.2123-1709.3	010503	Ø 23,8
1.9 TDI 4motion	85	01/00→04/01			→ 08/00; für Linkslenker; +PR 1AT	03.2123-2024.3	010597	ATE Ø 23,8
					09/00→; für Linkslenker; +PR 1AT	03.2123-2715.3	010802	ATE Ø 23,8
					09/00→; für Rechtslenker; +PR 1AT	03.2123-2774.3	010803	ATE Ø 23,8
					für Linkslenker; +PR 1AM / 1AC / 1AH / 1AJ	24.2123-1709.3	010503	Ø 23,8











	kw			 	! #		
VW - GOLF IV Variant (1J5) 05/99→06/06							
Bremskraftverstärker							
1.4 16V 1.6	55 74 - 75	05/99→06/06 05/99→06/06		09/00→; für Linkslenker; +PR 1AT; → 10/01		03.7860-0602.4 300141	ATE Ø 10" pneumatisch
1.6 16V	77	02/00→06/06		→ 08/00; für Linkslenker; +PR 1AT		03.7863-0402.4 300124	ATE Ø 10" pneumatisch
1.8 4motion	92	05/99→06/06		11/01→; für Linkslenker; +PR 1AT		03.7863-3502.4 300128	ATE Ø 10" pneumatisch
1.8 T	110	05/00→06/06					
1.9 SDI	50	05/99→06/06					
1.9 TDI	66	05/99→05/06					
1.9 TDI 4motion	66	05/99→04/02					
2.0	85	05/99→06/06					
2.3 V5	110	05/99→06/06					
2.3 V5 4motion	110	05/99→06/06					
2.8 V6 4motion	150	05/99→06/06					
1.6 FSI	81	01/02→06/06		für Linkslenker; +PR 1AT		03.7863-3502.4 300128	ATE Ø 10" pneumatisch
1.9 TDI 4motion	110	05/02→06/05					
2.0 Bi-Fuel	85	02/02→06/06					
1.9 TDI	74 - 110	09/00→06/06		für Linkslenker; +PR 1AT; → 10/01		03.7860-0602.4 300141	ATE Ø 10" pneumatisch
1.9 TDI 4motion	74	09/00→06/06		11/01→; für Linkslenker; +PR 1AT		03.7863-3502.4 300128	ATE Ø 10" pneumatisch
2.0 4motion	85	10/00→06/06					
2.3 V5	125	10/00→06/06					
2.3 V5 4motion	125	10/00→06/06					
1.9 TDI	81 - 85	05/99→06/01		09/00→; für Linkslenker; +PR 1AT		03.7860-0602.4 300141	ATE Ø 10" pneumatisch
1.9 TDI 4motion	85	12/99→04/01		→ 08/00; für Linkslenker; +PR 1AT		03.7863-0402.4 300124	ATE Ø 10" pneumatisch
1.9 TDI	96	11/00→06/06		04/01→; für Linkslenker; +PR 1AT; → 10/01		03.7860-0602.4 300141	ATE Ø 10" pneumatisch
1.9 TDI 4motion	96	11/00→06/06		11/01→; für Linkslenker; +PR 1AT		03.7863-3502.4 300128	ATE Ø 10" pneumatisch
Hauptbremszylinder							
1.4 16V 1.6	55 74 - 75	05/99→06/06 05/99→06/06		→ 08/00; für Linkslenker; +PR 1AT		03.2123-2024.3 010597	ATE Ø 23,8
1.6 16V	77	02/00→06/06		09/00→; für Linkslenker; +PR 1AT		03.2123-2715.3 010802	ATE Ø 23,8
1.8 4motion	92	05/99→06/06		09/00→; für Rechtslenker; +PR 1AT		03.2123-2774.3 010803	ATE Ø 23,8
1.8 T	110	05/00→06/06		für Linkslenker; +PR 1AM / 1AC / 1AH / 1AJ		24.2123-1709.3 010503	Ø 23,8
1.9 SDI	50	05/99→06/06					
1.9 TDI	66 - 85	05/99→05/06					
1.9 TDI 4motion	66 - 85	05/99→04/02					
2.0	85	05/99→06/06					
2.3 V5	110	05/99→06/06					
2.3 V5 4motion	110	05/99→06/06					
2.8 V6 4motion	150	05/99→06/06					
1.6 FSI	81	01/02→06/06		für Linkslenker; +PR 1AT		03.2123-2715.3 010802	ATE Ø 23,8
1.9 TDI	74 - 110	09/00→06/06		für Rechtslenker; +PR 1AT		03.2123-2774.3 010803	ATE Ø 23,8
1.9 TDI 4motion	74 - 110	09/00→06/06		für Linkslenker; +PR 1AM / 1AC / 1AH / 1AJ		24.2123-1709.3 010503	Ø 23,8
2.0 4motion	85	10/00→06/06					
2.0 Bi-Fuel	85	02/02→06/06					
2.3 V5	125	10/00→06/06					
2.3 V5 4motion	125	10/00→06/06					
1.9 TDI	96	11/00→06/06		04/01→; für Linkslenker; +PR 1AT		03.2123-2715.3 010802	ATE Ø 23,8
1.9 TDI 4motion	96	11/00→06/06		04/01→; für Rechtslenker; +PR 1AT		03.2123-2774.3 010803	ATE Ø 23,8
				04/01→; für Linkslenker; +PR 1AM / 1AC / 1AH / 1AJ		24.2123-1709.3 010503	Ø 23,8
VW - GOLF V (1K1) 10/03→07/10							
Bremskraftverstärker							
1.4 16V 1.4 FSI	55 66	10/03→05/06 10/03→07/06		für Linkslenker; +PR 1AC / 1AT		03.7863-3232.4 300307	ATE Ø 10" pneumatisch
1.6 FSI	85	10/03→07/08					
2.0	85	01/05→11/08					
1.4 16V 1.4 TSI	59 90 - 125	05/06→11/08 11/05→11/08		für Linkslenker; → 09/08; +PR 1AC / 1AT		03.7863-3232.4 300307	ATE Ø 10" pneumatisch
1.6	75	01/04→11/08					
1.6 MultiFuel	75	10/07→11/08					
1.9 TDI	66 - 77	10/03→11/08					
1.9 TDI 4motion	77	08/04→11/08					
2.0 FSI	110	01/04→11/08					
2.0 FSI 4motion	110	08/04→11/08					
2.0 SDI	55	01/04→11/08					
2.0 TDI	100 - 125	10/03→11/08					
2.0 TDI 16V →	103	10/03→11/08					











	kw			 	! #		
VW - GOLF V (1K1) 10/03→07/10							
Bremskraftverstärker							
2.0 TDI 16V 4motion 2.0 TDI 4motion 2.5	103 103 125	08/04→11/08 01/07→11/08 05/07→11/08		für Linkslenker; → 09/08; +PR 1AC / 1AT		03.7863-3232.4 300307	ATE Ø 10" pneumatisch
2.0 GTI 3.2 R32 4motion	147 - 169 184	10/04→02/09 11/05→11/08		für Linkslenker; → 09/08; +PR 1AC / 1AT		03.7863-3332.4 300308	ATE Ø 10" pneumatisch
Hauptbremszylinder							
1.4 16V 1.4 FSI 1.6 FSI	55 66 85	10/03→05/06 10/03→07/06 10/03→07/08		für Linkslenker; → 1K-6W078889		03.2122-2129.3 010799	ATE Ø 22,2
				1K-6W078890→; für Linkslenker		03.2122-2129.3 010799	ATE Ø 22,2
				für Rechtslenker; +PR 1AC / 1AT		24.2122-1981.3 011024	ATE Ø 22,2 ohne Bremsflüssigkeitsbehälter
				für Rechtslenker; +PR 1AS		24.4152-0132.3 011025	ATE Ø 22,2 ohne Bremsflüssigkeitsbehälter
1.4 16V 1.4 TSI	59 103 - 125	05/06→11/08 11/05→11/08		1K-6W078890→; für Linkslenker; → 09/08		03.2122-2129.3 010799	ATE Ø 22,2
1.6 1.6 MultiFuel 1.9 TDI	75 75 66 - 77	01/04→11/08 10/07→11/08 10/03→11/08		für Linkslenker; → 1K-6W078889		03.2122-2129.3 010799	ATE Ø 22,2
1.9 TDI 4motion 2.0 FSI 2.0 FSI 4motion 2.0 SDI 2.0 TDI	77 110 110 55 100 - 125	08/04→11/08 01/04→11/08 08/04→11/08 01/04→11/08 10/03→11/08		für Rechtslenker; → 09/08; +PR 1AC / 1AT		24.2122-1981.3 011024	ATE Ø 22,2 ohne Bremsflüssigkeitsbehälter
2.0 TDI 16V 2.0 TDI 16V 4motion 2.0 TDI 4motion	110 110 103	01/04→11/08 08/04→11/08 01/07→11/08		für Rechtslenker; → 09/08; +PR 1AS		24.4152-0132.3 011025	ATE Ø 22,2 ohne Bremsflüssigkeitsbehälter
1.4 TSI 2.5	90 125	05/07→11/08 05/07→11/08		→ 09/08; für Linkslenker		03.2122-2129.3 010799	ATE Ø 22,2
				für Rechtslenker; → 09/08; +PR 1AC / 1AT		24.2122-1981.3 011024	ATE Ø 22,2 ohne Bremsflüssigkeitsbehälter
				für Rechtslenker; → 09/08; +PR 1AS		24.4152-0132.3 011025	ATE Ø 22,2 ohne Bremsflüssigkeitsbehälter
2.0	85	01/05→11/08		1K-6W078890→; für Linkslenker; → 09/08		03.2122-2129.3 010799	ATE Ø 22,2
				für Linkslenker; → 1K-6W078889		03.2122-2129.3 010799	ATE Ø 22,2
				08/06→; → 1K-6W078889; für Linkslenker		24.2122-1788.3 011145	FTE Ø 22,2 ohne Bremsflüssigkeitsbehälter
				für Rechtslenker; → 09/08; +PR 1AC / 1AT		24.2122-1981.3 011024	ATE Ø 22,2 ohne Bremsflüssigkeitsbehälter
				für Rechtslenker; → 09/08; +PR 1AS		24.4152-0132.3 011025	ATE Ø 22,2 ohne Bremsflüssigkeitsbehälter
2.0 GTI	147 - 169	10/04→02/09		1K-6W078890→; für Linkslenker; → 09/08		03.2123-3449.3 010808	ATE Ø 23,8
				für Linkslenker; → 1K-6W078889		03.2123-3449.3 010808	ATE Ø 23,8
				für Rechtslenker; → 09/08; +PR 1AC / 1AT		24.2122-1981.3 011024	ATE Ø 22,2 ohne Bremsflüssigkeitsbehälter
				für Rechtslenker; → 09/08; +PR 1AS		24.4152-0132.3 011025	ATE Ø 22,2 ohne Bremsflüssigkeitsbehälter
				1K-6W078890→; für Rechtslenker; → 09/08		24.4153-0202.3 011027	ATE Ø 23,8 ohne Bremsflüssigkeitsbehälter
3.2 R32 4motion	184	11/05→11/08		1K-6W078890→; für Linkslenker; → 09/08		03.2123-3449.3 010808	ATE Ø 23,8
				für Linkslenker; → 1K-6W078889		03.2123-3449.3 010808	ATE Ø 23,8
				1K-6W078890→; für Rechtslenker; → 09/08		24.4153-0202.3 011027	ATE Ø 23,8 ohne Bremsflüssigkeitsbehälter
Drucksensor, Bremskraftverstärker							
1.4 16V 1.4 FSI 1.6 FSI	55 66 85	10/03→05/06 10/03→07/06 10/03→07/08		für Linkslenker; +PR 1AS		03.0655-0101.2 370008	ATE
1.4 16V 1.4 TSI	59 90 - 125	05/06→11/08 11/05→11/08		für Linkslenker; → 09/08; +PR 1AS		03.0655-0101.2 370008	ATE
1.6 1.6 MultiFuel 1.9 TDI	75 75 66 - 77	01/04→11/08 10/07→11/08 10/03→11/08					
1.9 TDI 4motion 2.0 2.0 FSI →	77 85 110	08/04→11/08 01/05→11/08 01/04→11/08					























	kW			 	! #		
VW - GOLF V (1K1) 10/03→07/10							
Drucksensor, Bremskraftverstärker							
2.0 FSI 4motion	110	08/04→11/08		für Linkslenker; → 09/08; +PR 1AS		03.0655-0101.2 370008	ATE
2.0 SDI	55	01/04→11/08					
2.0 TDI	100 - 125	10/03→11/08					
2.0 TDI 16V	103	10/03→11/08					
2.0 TDI 16V 4motion	103	08/04→11/08					
2.0 TDI 4motion	103	01/07→11/08					
2.5	125	05/07→11/08					
VW - GOLF V Variant (1K5) 01/07→07/09							
Bremskraftverstärker							
1.4	59	06/07→07/09		→ 06/09; für Linkslenker; +PR 1AC / 1AT		03.7863-3232.4 300307	ATE Ø 10" pneumatisch
1.4 TSI	90 - 103	06/07→07/09					
1.6	75	06/07→07/09					
1.6 MultiFuel	75	11/07→07/09					
1.9 TDI	77	06/07→07/09					
1.9 TDI 4motion	77	01/08→07/09					
2.0 TDI	100 - 103	06/07→07/09					
2.0 TDI 16V	103	06/07→07/09					
1.4 TSI	118 - 125	06/07→07/09		→ 06/09; für Rechtslenker; +PR 1AC / 1AT / 1LL / 1LJ		03.7848-9802.4 300344	ATE Ø 7 / 8" pneumatisch
2.0 TFSI	147	06/07→07/09		→ 06/09; für Linkslenker; +PR 1AC / 1AT		03.7863-3332.4 300308	ATE Ø 10" pneumatisch
Hauptbremszylinder							
1.4	59	06/07→07/09		→ 06/09; für Linkslenker		03.2122-2129.3 010799	ATE Ø 22,2
				→ 06/09; für Linkslenker; +PR 1AC / 1AT		24.2122-1788.3 011145	FTE Ø 22,2 ohne Bremsflüssigkeitsbehälter
				→ 06/09; für Rechtslenker		24.4152-0132.3 011025	ATE Ø 22,2 ohne Bremsflüssigkeitsbehälter
1.4 TSI	90 - 103	06/07→07/09		→ 06/09; für Linkslenker; +PR 1AS		03.2122-2129.3 010799	ATE Ø 22,2
1.6	75	06/07→07/09		→ 06/09; für Linkslenker; +PR 1AC / 1AT		24.2122-1788.3 011145	FTE Ø 22,2 ohne Bremsflüssigkeitsbehälter
1.6 MultiFuel	75	11/07→07/09		→ 06/09; für Rechtslenker		24.4152-0132.3 011025	ATE Ø 22,2 ohne Bremsflüssigkeitsbehälter
1.4 TSI	118	07/08→07/09		→ 06/09; für Linkslenker		03.2122-2129.3 010799	ATE Ø 22,2
				→ 06/09; +PR 1LJ / 1LL; für Linkslenker		03.2123-3449.3 010808	ATE Ø 23,8
				→ 06/09; für Linkslenker; +PR 1AC / 1AT		24.2122-1788.3 011145	FTE Ø 22,2 ohne Bremsflüssigkeitsbehälter
				→ 06/09; für Rechtslenker		24.4152-0132.3 011025	ATE Ø 22,2 ohne Bremsflüssigkeitsbehälter
				→ 06/09; +PR 1LJ / 1LL; für Rechtslenker		24.4153-0202.3 011027	ATE Ø 23,8 ohne Bremsflüssigkeitsbehälter
1.4 TSI	125	06/07→07/09		→ 06/09; für Linkslenker; +PR 1AS		03.2122-2129.3 010799	ATE Ø 22,2
				→ 06/09; +PR 1LJ / 1LL; für Linkslenker		03.2123-3449.3 010808	ATE Ø 23,8
				→ 06/09; für Linkslenker; +PR 1AC / 1AT		24.2122-1788.3 011145	FTE Ø 22,2 ohne Bremsflüssigkeitsbehälter
				→ 06/09; für Rechtslenker		24.4152-0132.3 011025	ATE Ø 22,2 ohne Bremsflüssigkeitsbehälter
				→ 06/09; +PR 1LJ / 1LL; für Rechtslenker		24.4153-0202.3 011027	ATE Ø 23,8 ohne Bremsflüssigkeitsbehälter
1.9 TDI	77	06/07→07/09		→ 06/09; für Linkslenker; +PR 1AC / 1AT		03.2122-2129.3 010799	ATE Ø 22,2
1.9 TDI 4motion	77	01/08→07/09				24.2122-1788.3 011145	FTE Ø 22,2 ohne Bremsflüssigkeitsbehälter
2.0 TDI	100 - 103	06/07→07/09					
2.0 TDI 16V	103	06/07→07/09		→ 06/09; für Rechtslenker		24.4152-0132.3 011025	ATE Ø 22,2 ohne Bremsflüssigkeitsbehälter
2.0 TFSI	147	06/07→07/09		→ 06/09; für Linkslenker; +PR 1AC / 1AT		03.2122-2129.3 010799	ATE Ø 22,2
				→ 06/09; +PR 1LJ / 1LL; für Linkslenker		03.2123-3449.3 010808	ATE Ø 23,8
				→ 06/09; für Rechtslenker		24.4152-0132.3 011025	ATE Ø 22,2 ohne Bremsflüssigkeitsbehälter
				→ 06/09; +PR 1LJ / 1LL; für Rechtslenker		24.4153-0202.3 011027	ATE Ø 23,8 ohne Bremsflüssigkeitsbehälter
Drucksensor, Bremskraftverstärker							
1.4 TSI	90 - 118	06/07→07/09		→ 06/09; für Linkslenker; +PR 1AS		03.0655-0101.2 370008	ATE
2.0 TDI	100 - 103	06/07→07/09					
2.0 TDI 16V	103	06/07→07/09					
→							







	kw				! #		
VW - GOLF V Variant (1K5) 01/07→07/09							
Drucksensor, Bremskraftverstärker							
1.4 TSI	103 - 125	06/07→07/09		→ 06/09; für Rechtslenker; +PR 1AS		03.0655-0101.2 370008	ATE
1.6 1.6 MultiFuel	75	06/07→07/09 11/07→07/09		→ 06/09; +PR 1AS		03.0655-0101.2 370008	ATE
VW - GOLF VI (5K1) 10/08→12/14							
Bremskraftverstärker							
1.2 TSI	63	05/10→11/12		für Rechtslenker; +PR 1ZA / 1ZB / 1ZE / 1LJ		03.7848-9802.4 300344	ATE Ø 7 / 8" pneumatisch
1.4	59	10/08→11/12		1K-9-400001→; → 11/10; für Linkslenker; +PR 1ZK		03.7860-8802.4 300291	ATE Ø 10" pneumatisch
1.4 TSI	90 - 118	10/08→11/12					
1.6	75	10/08→11/12		für Linkslenker; +PR 1ZD / 1ZF / 1ZP / 1LV		03.7863-3232.4 300307	ATE Ø 10" pneumatisch
1.6 BiFuel	75	03/09→11/12					
1.6 MultiFuel	75	10/08→11/12					
1.6 TDI	66 - 77	02/09→11/12		1K-9-400001→; → 11/10; für Linkslenker; +PR 1ZA / 1ZB / 1ZE / 1LJ		03.7863-3332.4 300308	ATE Ø 10" pneumatisch
2.0 GTI	147 - 155	04/09→11/13		→ 1K-9-200000; für Linkslenker; +PR 1LJ / 1LL / 1LM		03.7863-3332.4 300308	ATE Ø 10" pneumatisch
2.0 R 4motion	188 - 199	11/09→11/13					
2.0 TDI	81 - 125	10/08→05/13					
2.0 TDI 4motion	103	05/09→11/12					
2.5	125	07/09→05/13					
1.2 TSI	77	11/08→11/12		05/09→; für Rechtslenker; +PR 1ZA / 1ZB / 1ZE / 1LJ		03.7848-9802.4 300344	ATE Ø 7 / 8" pneumatisch
				1K-9-400001→; → 11/10; für Linkslenker; +PR 1ZK		03.7860-8802.4 300291	ATE Ø 10" pneumatisch
				05/09→; für Linkslenker; +PR 1ZD / 1ZF / 1ZP / 1LV		03.7863-3232.4 300307	ATE Ø 10" pneumatisch
				1K-9-400001→; → 11/10; für Linkslenker; +PR 1ZA / 1ZB / 1ZE / 1LJ		03.7863-3332.4 300308	ATE Ø 10" pneumatisch
				05/09→; → 1K-9-200000; für Linkslenker; +PR 1LJ / 1LL / 1LM		03.7863-3332.4 300308	ATE Ø 10" pneumatisch
1.8 TSI	118	06/09→01/11		für Rechtslenker; +PR 1ZA / 1ZB / 1ZE / 1LJ		03.7848-9802.4 300344	ATE Ø 7 / 8" pneumatisch
				1K-9-400001→; → 11/10; für Linkslenker; +PR 1ZK		03.7860-8802.4 300291	ATE Ø 10" pneumatisch
				für Linkslenker; +PR 1ZD / 1ZF / 1ZP / 1LV		03.7863-3232.4 300307	ATE Ø 10" pneumatisch
				→ 1K-9-200000; für Linkslenker		03.7863-3332.4 300308	ATE Ø 10" pneumatisch
				1K-9-400001→; → 11/10; für Linkslenker; +PR 1ZA / 1ZB / 1ZE / 1LJ		03.7863-3332.4 300308	ATE Ø 10" pneumatisch
2.0 GTI	173	05/11→11/12		für Rechtslenker; +PR 1ZA / 1ZB / 1ZE / 1LJ		03.7848-9802.4 300344	ATE Ø 7 / 8" pneumatisch
2.0 TFSI 4motion	191	09/11→11/13					
Blue E-Motion	65	12/10→11/13		für Linkslenker; +PR 1ZD / 1ZF / 1ZP / 1LV		03.7863-3232.4 300307	ATE Ø 10" pneumatisch
				→ 1K-9-200000; für Linkslenker; +PR 1LJ / 1LL / 1LM		03.7863-3332.4 300308	ATE Ø 10" pneumatisch
Hauptbremszylinder							
1.2 TSI	63	05/10→11/12		für Linkslenker; +PR 1ZD / 1ZF / 1ZP / 1LV		03.2122-2129.3 010799	ATE Ø 22,2
1.4	59	10/08→11/12					
1.4 TSI	90 - 118	10/08→11/12		für Linkslenker; +PR 1ZA / 1ZB / 1ZE / 1LJ		03.2123-3449.3 010808	ATE Ø 23,8
1.6	75	10/08→11/12		für Rechtslenker; +PR 1ZD / 1ZF / 1ZP / 1LV		24.4152-0132.3 011025	ATE Ø 22,2 ohne Bremsflüssigkeitsbehälter
1.6 BiFuel	75	03/09→11/12					
1.6 MultiFuel	75	10/08→11/12					
1.6 TDI	66 - 77	02/09→11/12		für Rechtslenker; +PR 1ZA / 1ZB / 1ZE / 1LJ		24.4153-0202.3 011027	ATE Ø 23,8 ohne Bremsflüssigkeitsbehälter
1.8 TSI	118	06/09→01/11					
2.0 GTI	147 - 173	04/09→11/13					
2.0 R 4motion	188 - 199	11/09→11/13					
2.0 TDI	81 - 125	10/08→05/13					
2.0 TDI 4motion	103	05/09→11/12					
2.0 TFSI 4motion	191	09/11→11/13					
2.5	125	07/09→05/13					
Blue E-Motion	65	12/10→11/13					
1.2 TSI	77	11/08→11/12		05/09→; für Linkslenker; +PR 1ZD / 1ZF / 1ZP / 1LV		03.2122-2129.3 010799	ATE Ø 22,2
				05/09→; für Linkslenker; +PR 1ZA / 1ZB / 1ZE / 1LJ		03.2123-3449.3 010808	ATE Ø 23,8
				05/09→; für Rechtslenker; +PR 1ZD / 1ZF / 1ZP / 1LV		24.4152-0132.3 011025	ATE Ø 22,2 ohne Bremsflüssigkeitsbehälter
→							









	kw				! #		
VW - GOLF VI (5K1) 10/08→12/14							
 Hauptbremszylinder							
1.2 TSI	77	11/08→11/12		05/09→; für Rechtslenker; +PR 1ZA / 1ZB / 1ZE / 1LJ		24.4153-0202.3 011027	ATE Ø 23,8 ohne Bremsflüssigkeitsbehälter
VW - GOLF VI Cabriolet (517) 03/11→10/17							
 Bremskraftverstärker							
1.2 TSI	77	03/11→05/16		06/11→; für Rechtslenker; +PR 1ZA / 1ZB / 1ZE		03.7848-9802.4 300344	ATE Ø 7 / 8" pneumatisch
1.4 TSI	118	03/11→05/16					
1.6 TDI	77	03/11→05/16		06/11→; für Linkslenker; +PR 1ZK		03.7860-8802.4 300291	ATE Ø 10" pneumatisch
				06/11→; für Linkslenker; +PR 1ZD / 1ZP / 1LV		03.7863-3232.4 300307	ATE Ø 10" pneumatisch
				06/11→; für Linkslenker; +PR 1ZA / 1ZB / 1ZE		03.7863-3332.4 300308	ATE Ø 10" pneumatisch
1.2 TSI 16V	77	11/13→05/16		für Rechtslenker; +PR 1ZA / 1ZB / 1ZE		03.7848-9802.4 300344	ATE Ø 7 / 8" pneumatisch
1.4 TSI	90 - 110	11/11→05/16		für Linkslenker; +PR 1ZK		03.7860-8802.4 300291	ATE Ø 10" pneumatisch
2.0 GTI	155	05/12→05/16		für Linkslenker; +PR 1ZD / 1ZP / 1LV		03.7863-3232.4 300307	ATE Ø 10" pneumatisch
2.0 R	195	01/13→05/16					
2.0 TDI	81 - 110	11/11→05/16		für Linkslenker; +PR 1ZA / 1ZB / 1ZE		03.7863-3332.4 300308	ATE Ø 10" pneumatisch
2.0 TSI	162	11/13→05/16					
 Hauptbremszylinder							
1.2 TSI	77	03/11→05/16		06/11→; für Linkslenker; +PR 1ZD / 1ZP / 1LV		03.2122-2129.3 010799	ATE Ø 22,2
1.4 TSI	118	03/11→05/16					
1.6 TDI	77	03/11→05/16		06/11→; für Linkslenker; +PR 1ZA / 1ZB / 1ZE / 1ZK		03.2123-3449.3 010808	ATE Ø 23,8
				06/11→; für Rechtslenker; +PR 1ZD / 1ZP		24.4152-0132.3 011025	ATE Ø 22,2 ohne Bremsflüssigkeitsbehälter
				06/11→; für Rechtslenker; +PR 1ZA / 1ZB / 1ZE / 1ZK		24.4153-0202.3 011027	ATE Ø 23,8 ohne Bremsflüssigkeitsbehälter
1.2 TSI 16V	77	11/13→05/16		für Linkslenker; +PR 1ZD / 1ZP / 1LV		03.2122-2129.3 010799	ATE Ø 22,2
1.4 TSI	90 - 110	11/11→05/16		für Linkslenker; +PR 1ZA / 1ZB / 1ZE / 1ZK		03.2123-3449.3 010808	ATE Ø 23,8
2.0 GTI	155	05/12→05/16					
2.0 R	195	01/13→05/16		für Rechtslenker; +PR 1ZD / 1ZP		24.4152-0132.3 011025	ATE Ø 22,2 ohne Bremsflüssigkeitsbehälter
2.0 TDI	81 - 110	11/11→05/16					
2.0 TSI	162	11/13→05/16		für Rechtslenker; +PR 1ZA / 1ZB / 1ZE / 1ZK		24.4153-0202.3 011027	ATE Ø 23,8 ohne Bremsflüssigkeitsbehälter
VW - GOLF VI Van (5K1_) 10/08→11/12							
 Bremskraftverstärker							
1.2 TSi	63	05/10→11/12		+PR 1ZA / 1ZB / 1ZE / 1LJ; für Rechtslenker		03.7848-9802.4 300344	ATE Ø 7 / 8" pneumatisch
1.2 TSi BlueMotion	77	05/09→11/12					
1.4 TSi	118	10/08→11/12		1K-9-400001→; → 11/10; +PR 1ZK; für Linkslenker		03.7860-8802.4 300291	ATE Ø 10" pneumatisch
1.6 TDi	66	02/09→11/12					
1.6 TDi BlueMotion	77	05/09→11/12		+PR 1ZD / 1ZF / 1ZP / 1LV; für Linkslenker		03.7863-3232.4 300307	ATE Ø 10" pneumatisch
2.0 TDi	103 - 125	09/09→11/12					
2.0 TSi R 4motion	199	11/09→11/12		1K-9-400001→; → 11/10; +PR 1ZA / 1ZB / 1ZE / 1LJ; für Linkslenker		03.7863-3332.4 300308	ATE Ø 10" pneumatisch
TSi	90	10/08→11/12		→ 1K-9-200000; +PR 1LJ / 1LL / 1LM; für Linkslenker		03.7863-3332.4 300308	ATE Ø 10" pneumatisch
2.0 GTi	155	02/09→11/12		04/09→; für Rechtslenker; +PR 1ZA / 1ZB / 1ZE / 1LJ		03.7848-9802.4 300344	ATE Ø 7 / 8" pneumatisch
				1K-9-400001→; → 11/10; +PR 1ZK; für Linkslenker		03.7860-8802.4 300291	ATE Ø 10" pneumatisch
				+PR 1ZD / 1ZF / 1ZP / 1LV; für Linkslenker		03.7863-3232.4 300307	ATE Ø 10" pneumatisch
				→ 1K-9-200000; +PR 1LJ / 1LL / 1LM; für Linkslenker		03.7863-3332.4 300308	ATE Ø 10" pneumatisch
				1K-9-400001→; → 11/10; +PR 1ZA / 1ZB / 1ZE / 1LJ; für Linkslenker		03.7863-3332.4 300308	ATE Ø 10" pneumatisch
 Hauptbremszylinder							
1.2 TSi	63	05/10→11/12		+PR 1ZD / 1ZF / 1ZP / 1LV; für Linkslenker		03.2122-2129.3 010799	ATE Ø 22,2
1.2 TSi BlueMotion	77	05/09→11/12					
1.4 TSi	118	10/08→11/12		+PR 1ZA / 1ZB / 1ZE / 1LJ; für Linkslenker		03.2123-3449.3 010808	ATE Ø 23,8
1.6 TDi	66	02/09→11/12					
1.6 TDi BlueMotion	77	05/09→11/12		+PR 1ZD / 1ZF / 1ZP / 1LV; für Rechtslenker		24.4152-0132.3 011025	ATE Ø 22,2 ohne Bremsflüssigkeitsbehälter
2.0 GTi	155	02/09→11/12					
2.0 TDi	103 - 125	09/09→11/12		+PR 1ZA / 1ZB / 1ZE / 1LJ; für Rechtslenker		24.4153-0202.3 011027	ATE Ø 23,8 ohne Bremsflüssigkeitsbehälter
2.0 TSi R 4motion	199	11/09→11/12					
TSi	90	10/08→11/12					

	kw					! #		
VW - GOLF VI Variant (AJ5) 07/09→07/14								
 Bremskraftverstärker								
1.2 TSI 1.6 MultiFuel 1.6 TDI 2.0 TDI	63 75 66 81	07/10→07/13 07/10→07/13 12/09→07/13 01/10→07/13		+PR 1AC / 1AT / 1ZA / 1LL / 1LJ / 1ZE; für Rechtslenker		03.7848-9802.4	300344	ATE Ø 7 / 8" pneumatisch
				für Linkslenker; +PR 1AC / 1AT / 1ZD / 1ZP		03.7863-3232.4	300307	ATE Ø 10" pneumatisch
1.2 TSI 1.4 1.4 TSI	77 59 90 - 118	07/09→07/13 07/09→07/13 07/09→07/13		12/09→; +PR 1AC / 1AT / 1ZA / 1LL / 1LJ / 1ZE; für Rechtslenker		03.7848-9802.4	300344	ATE Ø 7 / 8" pneumatisch
				12/09→; für Linkslenker; +PR 1ZD / 1ZP		03.7863-3232.4	300307	ATE Ø 10" pneumatisch
1.6 1.6 BiFuel 1.6 TDI 1.6 TDI 4motion 2.0 TDI 2.0 TFSI	75 75 77 77 100 - 103 147	07/09→07/13 07/09→12/10 07/09→07/13 07/09→07/13 07/09→07/13 07/09→07/13		+PR 1AC / 1AT; → 11/09; für Linkslenker		03.7863-3332.4	300308	ATE Ø 10" pneumatisch
 Hauptbremszylinder								
1.2 TSI 1.6 MultiFuel	63 75	07/10→07/13 07/10→07/13		für Linkslenker; +PR 1ZD / 1ZP		03.2122-2129.3	010799	ATE Ø 22,2
				+PR 1ZD / 1ZP; für Rechtslenker		24.2122-1788.3	011145	FTE Ø 22,2 ohne Bremsflüssigkeitsbehälter
				+PR 1LJ / 1ZA / 1ZE; für Rechtslenker		24.4152-0132.3	011025	ATE Ø 22,2 ohne Bremsflüssigkeitsbehälter
				+PR 1LJ / 1ZA / 1ZE; für Rechtslenker		24.4153-0202.3	011027	ATE Ø 23,8 ohne Bremsflüssigkeitsbehälter
1.2 TSI 1.4 1.4 TSI	77 59 90 - 118	07/09→07/13 07/09→07/13 07/09→07/13		12/09→; für Linkslenker; +PR 1ZD / 1ZP		03.2122-2129.3	010799	ATE Ø 22,2
				→ 11/09; für Linkslenker; +PR 1AC / 1AT		24.2122-1788.3	011145	FTE Ø 22,2 ohne Bremsflüssigkeitsbehälter
1.6 1.6 BiFuel 1.6 TDI 1.6 TDI 4motion 2.0 TDI 2.0 TFSI	75 75 77 77 100 - 103 147	07/09→07/13 07/09→12/10 07/09→07/13 07/09→07/13 07/09→07/13 07/09→07/13		→ 11/09; für Linkslenker; +PR 1AC / 1AT		03.2122-2129.3	010799	ATE Ø 22,2
				→ 11/09; für Rechtslenker		24.2122-1788.3	011145	FTE Ø 22,2 ohne Bremsflüssigkeitsbehälter
				→ 11/09; +PR 1LJ / 1LL		03.2123-3449.3	010808	ATE Ø 23,8
				→ 11/09; für Rechtslenker		24.4152-0132.3	011025	ATE Ø 22,2 ohne Bremsflüssigkeitsbehälter
				12/09→; +PR 1ZD / 1ZP; für Rechtslenker		24.4152-0132.3	011025	ATE Ø 22,2 ohne Bremsflüssigkeitsbehälter
				→ 11/09; +PR 1LJ / 1LL; für Rechtslenker		24.4153-0202.3	011027	ATE Ø 23,8 ohne Bremsflüssigkeitsbehälter
				12/09→; +PR 1LJ / 1ZA / 1ZE; für Rechtslenker		24.4153-0202.3	011027	ATE Ø 23,8 ohne Bremsflüssigkeitsbehälter
1.6 TDI	66	12/09→07/13		für Linkslenker; +PR 1ZD / 1ZP		03.2122-2129.3	010799	ATE Ø 22,2
				+PR 1LJ / 1LL; für Linkslenker		24.2122-1788.3	011145	FTE Ø 22,2 ohne Bremsflüssigkeitsbehälter
				+PR 1ZD / 1ZP; für Rechtslenker		03.2123-3449.3	010808	ATE Ø 23,8
				+PR 1ZD / 1ZP; für Rechtslenker		24.4152-0132.3	011025	ATE Ø 22,2 ohne Bremsflüssigkeitsbehälter
				+PR 1LJ / 1ZA / 1ZE; für Rechtslenker		24.4153-0202.3	011027	ATE Ø 23,8 ohne Bremsflüssigkeitsbehälter
2.0 TDI	81	01/10→07/13		für Linkslenker; +PR 1AC / 1AT / 1ZD / 1ZP		03.2122-2129.3	010799	ATE Ø 22,2
				+PR 1ZD / 1ZP; für Rechtslenker		24.2122-1788.3	011145	FTE Ø 22,2 ohne Bremsflüssigkeitsbehälter
				+PR 1ZD / 1ZP; für Rechtslenker		24.4152-0132.3	011025	ATE Ø 22,2 ohne Bremsflüssigkeitsbehälter
				+PR 1LJ / 1ZA / 1ZE / 1LL; für Rechtslenker		24.4153-0202.3	011027	ATE Ø 23,8 ohne Bremsflüssigkeitsbehälter
VW - GOLF VII (5G1, BQ1, BE1, BE2) 08/12→10/21								
 Hauptbremszylinder								
1.0 TSI 1.2 TSI 1.4 TSI 1.4 TSI MultiFuel 1.5 TGI 1.5 TSI 1.6 1.6 TDI 1.6 TDI 4motion	63 - 85 77 - 81 92 - 110 90 - 92 96 - 110 96 - 110 81 66 - 85 77 - 81	05/15→08/20 11/12→03/17 05/14→03/21 11/12→07/18 11/18→08/20 04/17→08/20 05/14→07/17 04/13→08/20 11/12→03/17		für Linkslenker; +PR 1ZA / 1ZD / 1ZE / 1ZF / 1ZP		03.4153-5403.3	010994	ATE Ø 23,8
						24.4123-1719.3	011017	TRW Ø 23,8 ohne Bremsflüssigkeitsbehälter







	kW					! #		
VW - GOLF VII (5G1, BQ1, BE1, BE2) 08/12→10/21								
 Hauptbremszylinder								
2.0 GTD 2.0 GTI	135 155 - 180	04/13→08/20 04/13→08/20		für Linkslenker; +PR 1ZA / 1ZD / 1ZE / 1ZF / 1ZP		03.4153-5403.3 24.4123-1719.3	010994 011017	ATE Ø 23,8 TRW Ø 23,8 ohne Bremsflüssigkeitsbehälter
2.0 GTI Clubsport 2.0 GTI Clubsport S 2.0 GTI TCR 2.0 R 360S 4motion 2.0 R 4motion	195 228 213 265 206 - 228	02/16→03/17 09/16→03/17 11/18→08/20 09/16→03/17 11/13→08/20						
2.0 TDI 2.0 TDI 4motion	81 - 110 110	08/12→08/20 11/12→08/20						
1.2 TSI 1.4 TSI 1.6 TDI	63 103 77	08/12→03/17 08/12→07/17 08/12→03/17		11/12→; für Linkslenker; +PR 1ZA / 1ZD / 1ZE / 1ZF / 1ZP		03.4153-5403.3 24.4123-1719.3	010994 011017	ATE Ø 23,8 TRW Ø 23,8 ohne Bremsflüssigkeitsbehälter
1.4 TGI CNG	81	06/13→07/18		08/13→; für Linkslenker; +PR 1ZA / 1ZD / 1ZE / 1ZF / 1ZP		03.4153-5403.3 24.4123-1719.3	010994 011017	ATE Ø 23,8 TRW Ø 23,8 ohne Bremsflüssigkeitsbehälter
1.4 TSI 1.6 TDI	90 81	11/12→03/17 01/13→03/17		06/13→; für Linkslenker; +PR 1ZA / 1ZD / 1ZE / 1ZF / 1ZP		03.4153-5403.3 24.4123-1719.3	010994 011017	ATE Ø 23,8 TRW Ø 23,8 ohne Bremsflüssigkeitsbehälter
VW - GOLF VII Van (5G1) 08/12→03/17								
 Hauptbremszylinder								
1.2 TSi BlueMotion 1.4 TSi BlueMotion 1.6 TDi BlueMotion	63 103 77	08/12→03/17 08/12→03/17 08/12→03/17		11/12→; für Linkslenker; +PR 1ZA / 1ZD / 1ZE / 1ZF / 1ZP		03.4153-5403.3 24.4123-1719.3	010994 011017	ATE Ø 23,8 TRW Ø 23,8 ohne Bremsflüssigkeitsbehälter
1.2 TSi BlueMotion 1.4 TSi BlueMotion 1.6 TDi BlueMotion	77 90 66 - 81	11/12→03/17 05/13→03/17 04/13→03/17		für Linkslenker; +PR 1ZA / 1ZD / 1ZE / 1ZF / 1ZP		03.4153-5403.3 24.4123-1719.3	010994 011017	ATE Ø 23,8 TRW Ø 23,8 ohne Bremsflüssigkeitsbehälter
2.0 GTD 2.0 GTI	135 162 - 169	04/13→03/17 04/13→03/17						
2.0 TDi BlueMotion 2.0 TDi BlueMotion 4motion	110 110	05/13→05/14 05/13→05/14						
VW - GOLF VII Variant (BA5, BV5) 04/13→01/22								
 Hauptbremszylinder								
1.0 TSI 1.2 TSI 1.4 TSI	63 - 85 81 92 - 110	05/15→08/20 04/14→03/17 05/14→03/21		für Linkslenker; +PR 1ZA / 1ZD / 1ZE / 1ZF / 1ZP		03.4153-5403.3 24.4123-1719.3	010994 011017	ATE Ø 23,8 TRW Ø 23,8 ohne Bremsflüssigkeitsbehälter
1.4 TSI MultiFuel 1.5 TSI	92 96 - 110	05/14→03/17 04/17→08/20				24.4153-1522.3	011048	ATE Ø 23,8 ohne Bremsflüssigkeitsbehälter
1.6 1.6 TDI 2.0 GTD 2.0 R 360S 4motion 2.0 R 4motion	81 85 135 265 206 - 228	05/14→07/17 11/16→08/20 01/15→07/19 09/16→03/17 03/15→08/20						
1.2 TSI 1.4 TSI 1.6 TDI 1.6 TDI 4motion 2.0 TDI 2.0 TDI 4motion	63 - 77 90 - 103 66 - 81 77 - 81 81 - 110 110	04/13→08/20 05/13→08/20 05/13→07/18 05/13→03/17 04/13→08/20 04/13→08/20		07/13→; für Linkslenker; +PR 1ZA / 1ZD / 1ZE / 1ZF / 1ZP		03.4153-5403.3 24.4123-1719.3	010994 011017	ATE Ø 23,8 TRW Ø 23,8 ohne Bremsflüssigkeitsbehälter
1.6 TDI 1.6 TDI 4motion	66 - 81 77 - 81	05/13→07/18 05/13→03/17		12/13→; für Linkslenker; +PR 1ZA / 1ZD / 1ZE / 1ZF / 1ZP		24.4153-1522.3	011048	ATE Ø 23,8 ohne Bremsflüssigkeitsbehälter
1.4 TGI CNG 1.4 TSI MultiFuel	81 90	09/13→07/18 04/13→03/17		für Linkslenker; +PR 1ZA / 1ZD / 1ZE / 1ZF / 1ZP		03.4153-5403.3 24.4123-1719.3	010994 011017	ATE Ø 23,8 TRW Ø 23,8 ohne Bremsflüssigkeitsbehälter
1.5 TGI	96	12/18→08/20		für Linkslenker; +PR 1ZA / 1ZD / 1ZE / 1ZF / 1ZP		03.4153-5403.3 24.4123-1719.3	010994 011017	ATE Ø 23,8 TRW Ø 23,8 ohne Bremsflüssigkeitsbehälter







	kw				! #		
VW - GOLF ALLTRACK VII Variant (BA5, BV5) 12/14→12/20							
 Hauptbremszylinder							
1.6 TDI 4motion 2.0 TDI 4motion	81 110 - 135	12/14→03/17 12/14→08/20		+PR 1ZA / 1ZD / 1ZE / 1ZF / 1ZP	24.4123-1719.3	011017	TRW Ø 23,8 ohne Bremsflüssigkeitsbehälter
				+PR 1ZA / 1ZD / 1ZE / 1ZF / 1ZP; für Linkslenker	24.4153-1522.3	011048	ATE Ø 23,8 ohne Bremsflüssigkeitsbehälter
1.8 TSI 4motion	132	12/14→08/20		für Linkslenker; +PR 1ZA / 1ZD / 1ZE / 1ZF / 1ZP	03.4153-5403.3 24.4123-1719.3 24.4153-1522.3	010994 011017 011048	ATE Ø 23,8 TRW Ø 23,8 ohne Bremsflüssigkeitsbehälter ATE Ø 23,8 ohne Bremsflüssigkeitsbehälter
VW - GOLF Kasten/Schrägheck (1K1) 07/03→							
 Bremskraftverstärker							
TDI	77	11/03→02/06		für Linkslenker; +PR 1AC / 1AT	03.7863-3232.4	300307	ATE Ø 10" pneumatisch
 Hauptbremszylinder							
TDI	77	11/03→02/06		für Linkslenker; → 1K-6W078889	03.2122-2129.3 24.2122-1788.3	010799 011145	ATE Ø 22,2 FTE Ø 22,2 ohne Bremsflüssigkeitsbehälter
				1K-6W078890→; für Linkslenker	03.2122-2129.3	010799	ATE Ø 22,2
				für Rechtslenker; +PR 1AC / 1AT	24.2122-1981.3	011024	ATE Ø 22,2 ohne Bremsflüssigkeitsbehälter
				für Rechtslenker; +PR 1AS	24.4152-0132.3	011025	ATE Ø 22,2 ohne Bremsflüssigkeitsbehälter
Drucksensor, Bremskraftverstärker							
TDI	77	11/03→02/06		für Linkslenker; +PR 1AS	03.0655-0101.2	370008	ATE
VW - GOLF PLUS V (5M1, 521) 12/04→12/13							
 Bremskraftverstärker							
1.2 TSI 1.6 BiFuel 1.6 TDI 2.0 TDI	63 - 77 75 66 81	11/09→12/13 05/09→12/13 02/09→12/13 01/09→12/13		1K-9-900001→; für Rechtslenker; → 11/10; +PR 1ZA / 1ZB / 1ZE / 1LJ	03.7848-9802.4	300344	ATE Ø 7 / 8" pneumatisch
				1K-9-900001→; → 11/10; für Linkslenker; +PR 1ZK	03.7860-8802.4	300291	ATE Ø 10" pneumatisch
				12/10→; für Linkslenker; +PR 1ZF / 1AC	03.7863-3232.4	300307	ATE Ø 10" pneumatisch
				1K-9-900001→; → 11/10; für Linkslenker; +PR 1ZD / 1ZF / 1ZP / 1LV	03.7863-3232.4	300307	ATE Ø 10" pneumatisch
				12/10→; für Linkslenker; +PR 1ZA / 1ZE / 1AS / 1AT	03.7863-3332.4	300308	ATE Ø 10" pneumatisch
				1K-9-900001→; → 11/10; für Linkslenker; +PR 1ZA / 1ZB / 1ZE	03.7863-3332.4	300308	ATE Ø 10" pneumatisch
1.4 16V 1.4 FSI 1.4 TSI 1.6 FSI 1.9 TDI	55 66 103 85 66 - 77	01/05→11/06 07/05→11/06 05/06→06/08 12/04→05/08 01/05→01/09		1K-9-900001→; für Rechtslenker; +PR 1ZA / 1ZB / 1ZE / 1LJ	03.7848-9802.4	300344	ATE Ø 7 / 8" pneumatisch
				1K-9-900001→; für Linkslenker; +PR 1ZK	03.7860-8802.4	300291	ATE Ø 10" pneumatisch
				1K-9-900001→; für Linkslenker; +PR 1ZD / 1ZF / 1ZP / 1LV	03.7863-3232.4	300307	ATE Ø 10" pneumatisch
2.0 FSI 2.0 TDI	110 96	05/05→06/08 05/05→05/07		+PR 1AC / 1AT; für Linkslenker; → 1K-9-899999	03.7863-3232.4	300307	ATE Ø 10" pneumatisch
				1K-9-900001→; für Linkslenker; +PR 1ZA / 1ZB / 1ZE	03.7863-3332.4	300308	ATE Ø 10" pneumatisch
1.4 16V 1.4 TSI	59 90 - 118	05/06→12/13 06/07→12/13		1K-9-900001→; → 11/10; für Rechtslenker; +PR 1ZA / 1ZB / 1ZE / 1LJ	03.7848-9802.4	300344	ATE Ø 7 / 8" pneumatisch
				1K-9-900001→; → 11/10; für Linkslenker; +PR 1ZK	03.7860-8802.4	300291	ATE Ø 10" pneumatisch
1.6 1.6 MultiFuel 2.0 TDI	75 75 100 - 103	05/05→12/13 11/07→12/13 05/05→12/13		12/10→; für Linkslenker; +PR 1ZF / 1AC	03.7863-3232.4	300307	ATE Ø 10" pneumatisch
				1K-9-900001→; → 11/10; für Linkslenker; +PR 1ZD / 1ZF / 1ZP / 1LV	03.7863-3232.4	300307	ATE Ø 10" pneumatisch
2.0 TDI 16V	103	01/05→12/13		+PR 1AC / 1AT; für Linkslenker; → 1K-9-899999	03.7863-3232.4	300307	ATE Ø 10" pneumatisch
				12/10→; für Linkslenker; +PR 1ZA / 1ZE / 1AS / 1AT	03.7863-3332.4	300308	ATE Ø 10" pneumatisch
				1K-9-900001→; → 11/10; für Linkslenker; +PR 1ZA / 1ZB / 1ZE	03.7863-3332.4	300308	ATE Ø 10" pneumatisch
1.4 TSI	125	05/06→06/08		1K-9-900001→; für Rechtslenker; +PR 1ZA / 1ZB / 1ZE / 1LJ	03.7848-9802.4	300344	ATE Ø 7 / 8" pneumatisch
				1K-9-900001→; für Linkslenker; +PR 1ZK	03.7860-8802.4	300291	ATE Ø 10" pneumatisch
				1K-9-900001→; für Linkslenker; +PR 1ZD / 1ZF / 1ZP / 1LV	03.7863-3232.4	300307	ATE Ø 10" pneumatisch
				+PR 1AC / 1AT; für Linkslenker; → 1K-6-565000	03.7863-3232.4	300307	ATE Ø 10" pneumatisch









	kw			 	! #		
VW - GOLF PLUS V (5M1, 521) 12/04→12/13							
Bremskraftverstärker							
1.4 TSI	125	05/06→06/08		1K-9-900001→; für Linkslenker; +PR 1ZA / 1ZB / 1ZE	03.7863-3332.4	300308	ATE Ø 10" pneumatisch
				1K-6-565001→ 1K-9-899999; für Linkslenker; +PR 1AC / 1AT	03.7863-3332.4	300308	ATE Ø 10" pneumatisch
1.6 TDI	77	03/09→12/13		12/10→; für Rechtslenker; +PR 1ZA / 1ZE / 1AS / 1AT	03.7848-9802.4	300344	ATE Ø 7 / 8" pneumatisch
				1K-9-900001→; → 11/10; für Linkslenker; +PR 1ZK	03.7860-8802.4	300291	ATE Ø 10" pneumatisch
				12/10→; für Linkslenker; +PR 1ZF / 1AC	03.7863-3232.4	300307	ATE Ø 10" pneumatisch
				1K-9-900001→; → 11/10; für Linkslenker; +PR 1ZD / 1ZF / 1ZP / 1LV	03.7863-3232.4	300307	ATE Ø 10" pneumatisch
				12/10→; für Linkslenker; +PR 1ZA / 1ZE / 1AS / 1AT	03.7863-3332.4	300308	ATE Ø 10" pneumatisch
				1K-9-900001→; → 11/10; für Linkslenker; +PR 1ZA / 1ZB / 1ZE	03.7863-3332.4	300308	ATE Ø 10" pneumatisch
Hauptbremszylinder							
1.2 TSI	63 - 77	11/09→12/13		1K-C-500001→; für Linkslenker; +PR 1ZF / 1AC	03.2122-2129.3	010799	ATE Ø 22,2
1.6 BiFuel	75	05/09→12/13		1K-9-900001→; für Linkslenker; → 1K-C-500000; +PR 1ZF	03.2122-2129.3	010799	ATE Ø 22,2
1.6 TDI	66 - 77	02/09→12/13		1K-C-500001→; für Linkslenker; +PR 1ZA / 1ZE / 1AS / 1AT	03.2123-3449.3	010808	ATE Ø 23,8
2.0 TDI	81	01/09→12/13		1K-9-900001→; für Linkslenker; → 1K-C-500000; +PR 1ZE / 1LJ / 1ZA	03.2123-3449.3	010808	ATE Ø 23,8
				1K-9-900001→; für Rechtslenker; → 1K-C-500000; +PR 1ZF	24.4152-0132.3	011025	ATE Ø 22,2 ohne Bremsflüssigkeitsbehälter
				für Rechtslenker; 1K-C-500001→; +PR 1ZF / 1AC	24.4152-0132.3	011025	ATE Ø 22,2 ohne Bremsflüssigkeitsbehälter
				für Rechtslenker; 1K-C-500001→; +PR 1ZA / 1ZE / 1AS / 1AT	24.4153-0202.3	011027	ATE Ø 23,8 ohne Bremsflüssigkeitsbehälter
				1K-9-900001→; für Rechtslenker; → 1K-C-500000; +PR 1ZE / 1LJ / 1ZA	24.4153-0202.3	011027	ATE Ø 23,8 ohne Bremsflüssigkeitsbehälter
1.4 16V	55 - 59	01/05→12/13		1K-9-900001→; für Linkslenker; → 1K-C-500000; +PR 1ZF	03.2122-2129.3	010799	ATE Ø 22,2
1.4 FSI	66	07/05→11/06		→ 1K-6-565000; für Linkslenker	03.2122-2129.3	010799	ATE Ø 22,2
1.4 TSI	103	05/06→06/08		1K-6-565001→; für Linkslenker; → 1K-8-500000; +PR 1AC / 1AT / 1AS	03.2122-2129.3	010799	ATE Ø 22,2
1.6	75	05/05→12/13		1K-C-500001→; für Linkslenker; +PR 1ZF / 1AC	03.2122-2129.3	010799	ATE Ø 22,2
1.6 MultiFuel	75	11/07→12/13		1K-8-500001→ 1K-9-899999; für Linkslenker; +PR 1LK / 1ZA / 1ZC / 1ZD / 1ZE / 1ZF / 1ZM / 1ZP	03.2122-2129.3	010799	ATE Ø 22,2
1.9 TDI	66 - 77	01/05→01/09		1K-C-500001→; für Linkslenker; +PR 1ZF / 1AC	03.2122-2129.3	010799	ATE Ø 22,2
2.0 FSI	110	05/05→06/08		1K-8-500001→ 1K-9-899999; für Rechtslenker; +PR 1LK / 1ZA / 1ZC / 1ZD / 1ZE / 1ZF / 1ZM / 1ZP	03.2122-2129.3	010799	ATE Ø 22,2
2.0 TDI	96 - 103	05/05→12/13		1K-C-500001→; für Linkslenker; +PR 1ZA / 1ZE / 1AS / 1AT	03.2123-3449.3	010808	ATE Ø 23,8
2.0 TDI 16V	103	01/05→12/13		1K-6-565001→; für Linkslenker; → 1K-8-500000; +PR 1LJ	03.2123-3449.3	010808	ATE Ø 23,8
				1K-8-500001→ 1K-9-899999; für Linkslenker; +PR 1LJ	03.2123-3449.3	010808	ATE Ø 23,8
				1K-9-900001→; für Linkslenker; → 1K-C-500000; +PR 1ZE / 1LJ / 1ZA	03.2123-3449.3	010808	ATE Ø 23,8
				→ 1K-6-565000; für Rechtslenker	24.2122-1981.3	011024	ATE Ø 22,2 ohne Bremsflüssigkeitsbehälter
				für Rechtslenker; 1K-C-500001→; +PR 1ZF / 1AC	24.4152-0132.3	011025	ATE Ø 22,2 ohne Bremsflüssigkeitsbehälter
				1K-9-900001→; für Rechtslenker; → 1K-C-500000; +PR 1ZF	24.4152-0132.3	011025	ATE Ø 22,2 ohne Bremsflüssigkeitsbehälter
				1K-8-500001→ 1K-9-899999; für Rechtslenker; +PR 1LK / 1ZA / 1ZC / 1ZD / 1ZE / 1ZF / 1ZM / 1ZP	24.4152-0132.3	011025	ATE Ø 22,2 ohne Bremsflüssigkeitsbehälter
				1K-6-565001→; für Rechtslenker; → 1K-8-500000; +PR 1AC / 1AT / 1AS	24.4152-0132.3	011025	ATE Ø 22,2 ohne Bremsflüssigkeitsbehälter
				1K-8-500001→ 1K-9-899999; für Rechtslenker; +PR 1LJ	24.4153-0202.3	011027	ATE Ø 23,8 ohne Bremsflüssigkeitsbehälter
				1K-9-900001→; für Rechtslenker; → 1K-C-500000; +PR 1ZE / 1LJ / 1ZA	24.4153-0202.3	011027	ATE Ø 23,8 ohne Bremsflüssigkeitsbehälter
				für Rechtslenker; 1K-C-500001→; +PR 1ZA / 1ZE / 1AS / 1AT	24.4153-0202.3	011027	ATE Ø 23,8 ohne Bremsflüssigkeitsbehälter
1.4 TSI	90	06/07→12/13		1K-9-900001→; für Linkslenker; → 1K-C-500000; +PR 1ZF	03.2122-2129.3	010799	ATE Ø 22,2
				1K-C-500001→; für Linkslenker; +PR 1ZF / 1AC	03.2122-2129.3	010799	ATE Ø 22,2
→							











	kw			 	! #		
VW - GOLF PLUS V (5M1, 521) 12/04→12/13							
 Hauptbremszylinder							
1.4 TSI	90	06/07→12/13		1K-6-565001→; für Linkslenker; → 1K-8-500000; +PR 1AC / 1AT / 1AS	03.2122-2129.3	010799	ATE Ø 22,2
				1K-8-500001→ 1K-9-899999; für Linkslenker; +PR 1LK / 1ZA / 1ZC / 1ZD / 1ZE / 1ZF / 1ZM / 1ZP	03.2122-2129.3	010799	ATE Ø 22,2
				1K-C-500001→; für Linkslenker; +PR 1ZA / 1ZE / 1AS / 1AT	03.2123-3449.3	010808	ATE Ø 23,8
				1K-9-900001→; für Linkslenker; → 1K-C-500000; +PR 1ZE / 1LJ / 1ZA	03.2123-3449.3	010808	ATE Ø 23,8
				1K-8-500001→ 1K-9-899999; für Linkslenker; +PR 1LJ	03.2123-3449.3	010808	ATE Ø 23,8
				1K-6-565001→; für Linkslenker; → 1K-8-500000; +PR 1LJ	03.2123-3449.3	010808	ATE Ø 23,8
				für Rechtslenker; 1K-C-500001→; +PR 1ZF / 1AC	24.4152-0132.3	011025	ATE Ø 22,2 ohne Bremsflüssigkeitsbehälter
				1K-9-900001→; für Rechtslenker; → 1K-C-500000; +PR 1ZF	24.4152-0132.3	011025	ATE Ø 22,2 ohne Bremsflüssigkeitsbehälter
				1K-8-500001→ 1K-9-899999; für Rechtslenker; +PR 1LK / 1ZA / 1ZC / 1ZD / 1ZE / 1ZF / 1ZM / 1ZP	24.4152-0132.3	011025	ATE Ø 22,2 ohne Bremsflüssigkeitsbehälter
				1K-6-565001→; für Rechtslenker; → 1K-8-500000; +PR 1AC / 1AT / 1AS	24.4152-0132.3	011025	ATE Ø 22,2 ohne Bremsflüssigkeitsbehälter
				für Rechtslenker; 1K-C-500001→; +PR 1ZA / 1ZE / 1AS / 1AT	24.4153-0202.3	011027	ATE Ø 23,8 ohne Bremsflüssigkeitsbehälter
				1K-9-900001→; für Rechtslenker; → 1K-C-500000; +PR 1ZE / 1LJ / 1ZA	24.4153-0202.3	011027	ATE Ø 23,8 ohne Bremsflüssigkeitsbehälter
				1K-8-500001→ 1K-9-899999; für Rechtslenker; +PR 1LJ	24.4153-0202.3	011027	ATE Ø 23,8 ohne Bremsflüssigkeitsbehälter
1.4 TSI	118	06/08→12/13		1K-C-500001→; für Linkslenker; +PR 1ZF / 1AC	03.2122-2129.3	010799	ATE Ø 22,2
				1K-8-500001→ 1K-9-899999; für Linkslenker; +PR 1LK / 1ZA / 1ZC / 1ZD / 1ZE / 1ZF / 1ZM / 1ZP	03.2122-2129.3	010799	ATE Ø 22,2
				1K-9-900001→; für Linkslenker; → 1K-C-500000; +PR 1ZF	03.2122-2129.3	010799	ATE Ø 22,2
				1K-C-500001→; für Linkslenker; +PR 1ZA / 1ZE / 1AS / 1AT	03.2123-3449.3	010808	ATE Ø 23,8
				1K-8-500001→ 1K-9-899999; für Linkslenker; +PR 1LJ	03.2123-3449.3	010808	ATE Ø 23,8
				1K-9-900001→; für Linkslenker; → 1K-C-500000; +PR 1ZE / 1LJ / 1ZA	03.2123-3449.3	010808	ATE Ø 23,8
				für Rechtslenker; 1K-C-500001→; +PR 1ZF / 1AC	24.4152-0132.3	011025	ATE Ø 22,2 ohne Bremsflüssigkeitsbehälter
				1K-9-900001→; für Rechtslenker; → 1K-C-500000; +PR 1ZF	24.4152-0132.3	011025	ATE Ø 22,2 ohne Bremsflüssigkeitsbehälter
				1K-8-500001→ 1K-9-899999; für Rechtslenker; +PR 1LK / 1ZA / 1ZC / 1ZD / 1ZE / 1ZF / 1ZM / 1ZP	24.4152-0132.3	011025	ATE Ø 22,2 ohne Bremsflüssigkeitsbehälter
				für Rechtslenker; 1K-C-500001→; +PR 1ZA / 1ZE / 1AS / 1AT	24.4153-0202.3	011027	ATE Ø 23,8 ohne Bremsflüssigkeitsbehälter
				1K-8-500001→ 1K-9-899999; für Rechtslenker; +PR 1LJ	24.4153-0202.3	011027	ATE Ø 23,8 ohne Bremsflüssigkeitsbehälter
				1K-9-900001→; für Rechtslenker; → 1K-C-500000; +PR 1ZE / 1LJ / 1ZA	24.4153-0202.3	011027	ATE Ø 23,8 ohne Bremsflüssigkeitsbehälter
			1.4 TSI	125	05/06→06/08		1K-C-500001→; für Linkslenker; +PR 1ZF / 1AC
	→ 1K-6-565000; für Linkslenker	03.2122-2129.3				010799	ATE Ø 22,2
	1K-9-900001→; für Linkslenker; → 1K-C-500000; +PR 1ZF	03.2122-2129.3				010799	ATE Ø 22,2
	1K-8-500001→ 1K-9-899999; für Linkslenker; +PR 1LK / 1ZA / 1ZC / 1ZD / 1ZE / 1ZF / 1ZM / 1ZP	03.2122-2129.3				010799	ATE Ø 22,2
	1K-6-565001→; für Linkslenker; → 1K-8-500000; +PR 1AC / 1AT / 1AS	03.2122-2129.3				010799	ATE Ø 22,2
	1K-C-500001→; für Linkslenker; +PR 1ZA / 1ZE / 1AS / 1AT	03.2123-3449.3				010808	ATE Ø 23,8
	1K-6-565001→; für Linkslenker; → 1K-8-500000; +PR 1LJ	03.2123-3449.3				010808	ATE Ø 23,8
	1K-9-900001→; für Linkslenker; → 1K-C-500000; +PR 1ZE / 1LJ / 1ZA	03.2123-3449.3				010808	ATE Ø 23,8
	1K-8-500001→ 1K-9-899999; für Linkslenker; +PR 1LJ	03.2123-3449.3				010808	ATE Ø 23,8
	→ 1K-7-550000; für Rechtslenker	24.2122-1981.3				011024	ATE Ø 22,2 ohne Bremsflüssigkeitsbehälter













	kw			 	! #		
VW - GOLF PLUS V (5M1, 521) 12/04→12/13							
Hauptbremszylinder							
1.4 TSI	125	05/06→06/08		für Rechtslenker; 1K-C-500001→; +PR 1ZF / 1AC	24.4152-0132.3	011025	ATE Ø 22,2 ohne Bremsflüssigkeitsbehälter
				1K-9-900001→; für Rechtslenker; → 1K-C-500000; +PR 1ZF	24.4152-0132.3	011025	ATE Ø 22,2 ohne Bremsflüssigkeitsbehälter
				1K-8-500001→ 1K-9-899999; für Rechtslenker; +PR 1LK / 1ZA / 1ZC / 1ZD / 1ZE / 1ZF / 1ZM / 1ZP	24.4152-0132.3	011025	ATE Ø 22,2 ohne Bremsflüssigkeitsbehälter
				für Rechtslenker; 1K-C-500001→; +PR 1ZA / 1ZE / 1AS / 1AT	24.4153-0202.3	011027	ATE Ø 23,8 ohne Bremsflüssigkeitsbehälter
				1K-9-900001→; für Rechtslenker; → 1K-C-500000; +PR 1ZE / 1LJ / 1ZA	24.4153-0202.3	011027	ATE Ø 23,8 ohne Bremsflüssigkeitsbehälter
				1K-8-500001→ 1K-9-899999; für Rechtslenker; +PR 1LJ	24.4153-0202.3	011027	ATE Ø 23,8 ohne Bremsflüssigkeitsbehälter
				1K-7-550001→; für Rechtslenker; → 1K-8-500000; +PR 1AC / 1AT / 1AS / 1LJ	24.4153-0202.3	011027	ATE Ø 23,8 ohne Bremsflüssigkeitsbehälter
1.6 FSI	85	12/04→05/08		1K-C-500001→; für Linkslenker; +PR 1ZF / 1AC	03.2122-2129.3	010799	ATE Ø 22,2
				→ 1K-6-565000; für Linkslenker	03.2122-2129.3	010799	ATE Ø 22,2
				1K-6-565001→; für Linkslenker; → 1K-8-500000; +PR 1AC / 1AT / 1AS	03.2122-2129.3	010799	ATE Ø 22,2
				1K-8-500001→ 1K-9-899999; für Linkslenker; +PR 1LK / 1ZA / 1ZC / 1ZD / 1ZE / 1ZF / 1ZM / 1ZP	03.2122-2129.3	010799	ATE Ø 22,2
				1K-9-900001→; für Linkslenker; → 1K-C-500000; +PR 1ZF	03.2122-2129.3	010799	ATE Ø 22,2
				1K-C-500001→; für Linkslenker; +PR 1ZA / 1ZE / 1AS / 1AT	03.2123-3449.3	010808	ATE Ø 23,8
				1K-6-565001→; für Linkslenker; → 1K-8-500000; +PR 1LJ	03.2123-3449.3	010808	ATE Ø 23,8
				1K-8-500001→ 1K-9-899999; für Linkslenker; +PR 1LJ	03.2123-3449.3	010808	ATE Ø 23,8
				1K-9-900001→; für Linkslenker; → 1K-C-500000; +PR 1ZE / 1LJ / 1ZA	03.2123-3449.3	010808	ATE Ø 23,8
				01/05→; für Rechtslenker; → 1K-6-565000	24.2122-1981.3	011024	ATE Ø 22,2 ohne Bremsflüssigkeitsbehälter
				für Rechtslenker; 1K-C-500001→; +PR 1ZF / 1AC	24.4152-0132.3	011025	ATE Ø 22,2 ohne Bremsflüssigkeitsbehälter
				1K-9-900001→; für Rechtslenker; → 1K-C-500000; +PR 1ZF	24.4152-0132.3	011025	ATE Ø 22,2 ohne Bremsflüssigkeitsbehälter
				1K-8-500001→ 1K-9-899999; für Rechtslenker; +PR 1LK / 1ZA / 1ZC / 1ZD / 1ZE / 1ZF / 1ZM / 1ZP	24.4152-0132.3	011025	ATE Ø 22,2 ohne Bremsflüssigkeitsbehälter
				1K-6-565001→; für Rechtslenker; → 1K-8-500000; +PR 1AC / 1AT / 1AS	24.4152-0132.3	011025	ATE Ø 22,2 ohne Bremsflüssigkeitsbehälter
				1K-8-500001→ 1K-9-899999; für Rechtslenker; +PR 1LJ	24.4153-0202.3	011027	ATE Ø 23,8 ohne Bremsflüssigkeitsbehälter
				für Rechtslenker; 1K-C-500001→; +PR 1ZA / 1ZE / 1AS / 1AT	24.4153-0202.3	011027	ATE Ø 23,8 ohne Bremsflüssigkeitsbehälter
				1K-9-900001→; für Rechtslenker; → 1K-C-500000; +PR 1ZE / 1LJ / 1ZA	24.4153-0202.3	011027	ATE Ø 23,8 ohne Bremsflüssigkeitsbehälter
Drucksensor, Bremskraftverstärker							
1.4 16V	55 - 59	01/05→12/13		1K-6-565001→ 1K-9-899999; für Rechtslenker; +PR 1AS	03.0655-0101.2	370008	ATE
1.4 FSI	66	07/05→11/06		+PR 1AS; für Linkslenker; → 1K-9-899999	03.0655-0101.2	370008	ATE
1.4 TSI	90 - 118	05/06→12/13					
1.6	75	05/05→12/13					
1.6 FSI	85	12/04→05/08					
1.6 MultiFuel	75	11/07→12/13					
1.9 TDI	66 - 77	01/05→01/09					
2.0 FSI	110	05/05→06/08					
2.0 TDI	96 - 103	05/05→12/13					
2.0 TDI 16V	103	01/05→12/13					
1.4 TSI	125	05/06→06/08		1K-6-565001→ 1K-9-899999; für Rechtslenker; +PR 1AC / 1AT / 1AS	03.0655-0101.2	370008	ATE
				+PR 1AS; für Linkslenker; → 1K-6-565000	03.0655-0101.2	370008	ATE

	kw					! #				
VW - GOLF PLUS Van (521) 01/09→08/14										
Bremskraftverstärker										
1.2 TSi 1.6 TDi	77 66 - 77	11/09→08/14 02/09→08/14		1K-9-900001→; für Rechtslenker; → 11/10; +PR 1ZA / 1ZB / 1ZE / 1LJ	03.7848-9802.4	300344	ATE Ø 7 / 8" pneumatisch			
				1K-9-900001→; → 11/10; für Linkslenker; +PR 1ZK	03.7860-8802.4	300291	ATE Ø 10" pneumatisch			
				12/10→; für Linkslenker; +PR 1ZF / 1AC	03.7863-3232.4	300307	ATE Ø 10" pneumatisch			
				1K-9-900001→; → 11/10; für Linkslenker; +PR 1ZD / 1ZF / 1ZP / 1LV	03.7863-3232.4	300307	ATE Ø 10" pneumatisch			
				12/10→; für Linkslenker; +PR 1ZA / 1ZE / 1AS / 1AT	03.7863-3332.4	300308	ATE Ø 10" pneumatisch			
				1K-9-900001→; → 11/10; für Linkslenker; +PR 1ZA / 1ZB / 1ZE	03.7863-3332.4	300308	ATE Ø 10" pneumatisch			
1.4 TSi 2.0 TDi	90 - 118 103	01/09→08/14 11/09→08/14		1K-9-900001→; für Rechtslenker; → 11/10; +PR 1ZA / 1ZB / 1ZE / 1LJ	03.7848-9802.4	300344	ATE Ø 7 / 8" pneumatisch			
				1K-9-900001→; → 11/10; für Linkslenker; +PR 1ZK	03.7860-8802.4	300291	ATE Ø 10" pneumatisch			
				12/10→; für Linkslenker; +PR 1ZF / 1AC	03.7863-3232.4	300307	ATE Ø 10" pneumatisch			
				1K-9-900001→; → 11/10; für Linkslenker; +PR 1ZD / 1ZF / 1ZP / 1LV	03.7863-3232.4	300307	ATE Ø 10" pneumatisch			
				+PR 1AC / 1AT; für Linkslenker; → 1K-9-899999	03.7863-3232.4	300307	ATE Ø 10" pneumatisch			
				12/10→; für Linkslenker; +PR 1ZA / 1ZE / 1AS / 1AT	03.7863-3332.4	300308	ATE Ø 10" pneumatisch			
			1K-9-900001→; → 11/10; für Linkslenker; +PR 1ZA / 1ZB / 1ZE	03.7863-3332.4	300308	ATE Ø 10" pneumatisch				
Hauptbremszylinder										
1.2 TSi 1.6 TDi	77 66 - 77	11/09→08/14 02/09→08/14		1K-C-500001→; für Linkslenker; +PR 1ZF / 1AC	03.2122-2129.3	010799	ATE Ø 22,2			
				1K-9-900001→; für Linkslenker; → 1K-C-500000; +PR 1ZF	03.2122-2129.3	010799	ATE Ø 22,2			
				1K-C-500001→; für Linkslenker; +PR 1ZA / 1ZE / 1AS / 1AT	03.2123-3449.3	010808	ATE Ø 23,8			
				1K-9-900001→; für Linkslenker; → 1K-C-500000; +PR 1ZE / 1LJ / 1ZA	03.2123-3449.3	010808	ATE Ø 23,8			
				1K-9-900001→ 1K-C-500000; für Rechtslenker; +PR 1ZF	24.4152-0132.3	011025	ATE Ø 22,2 ohne Bremsflüssigkeitsbehälter			
				1K-C-500001→; für Rechtslenker; +PR 1ZF / 1AC	24.4152-0132.3	011025	ATE Ø 22,2 ohne Bremsflüssigkeitsbehälter			
				1K-C-500001→; für Rechtslenker; +PR 1ZA / 1ZE / 1AS / 1AT	24.4153-0202.3	011027	ATE Ø 23,8 ohne Bremsflüssigkeitsbehälter			
				1K-9-900001→ 1K-C-500000; für Rechtslenker; +PR 1ZE / 1LJ / 1ZA	24.4153-0202.3	011027	ATE Ø 23,8 ohne Bremsflüssigkeitsbehälter			
1.4 TSi	90	01/09→08/14		1K-9-900001→; für Linkslenker; → 1K-C-500000; +PR 1ZF	03.2122-2129.3	010799	ATE Ø 22,2			
				1K-C-500001→; für Linkslenker; +PR 1ZF / 1AC	03.2122-2129.3	010799	ATE Ø 22,2			
				1K-6-565001→; für Linkslenker; → 1K-8-500000; +PR 1AC / 1AT / 1AS	03.2122-2129.3	010799	ATE Ø 22,2			
				1K-8-500001→ 1K-9-899999; für Linkslenker; +PR 1LK / 1ZA / 1ZC / 1ZD / 1ZE / 1ZF / 1ZM / 1ZP	03.2122-2129.3	010799	ATE Ø 22,2			
				1K-C-500001→; für Linkslenker; +PR 1ZA / 1ZE / 1AS / 1AT	03.2123-3449.3	010808	ATE Ø 23,8			
				1K-9-900001→; für Linkslenker; → 1K-C-500000; +PR 1ZE / 1LJ / 1ZA	03.2123-3449.3	010808	ATE Ø 23,8			
				1K-8-500001→ 1K-9-899999; für Linkslenker; +PR 1LJ	03.2123-3449.3	010808	ATE Ø 23,8			
				1K-6-565001→; für Linkslenker; → 1K-8-500000; +PR 1LJ	03.2123-3449.3	010808	ATE Ø 23,8			
				1K-C-500001→; für Rechtslenker; +PR 1ZF / 1AC	24.4152-0132.3	011025	ATE Ø 22,2 ohne Bremsflüssigkeitsbehälter			
				1K-9-900001→ 1K-C-500000; für Rechtslenker; +PR 1ZF	24.4152-0132.3	011025	ATE Ø 22,2 ohne Bremsflüssigkeitsbehälter			
				1K-8-500001→; für Rechtslenker; → 1K-9-899999; +PR 1LK / 1ZA / 1ZC / 1ZD / 1ZE / 1ZF / 1ZM / 1ZP	24.4152-0132.3	011025	ATE Ø 22,2 ohne Bremsflüssigkeitsbehälter			
				1K-6-565001→; für Rechtslenker; → 1K-8-500000; +PR 1AC / 1AT / 1AS	24.4152-0132.3	011025	ATE Ø 22,2 ohne Bremsflüssigkeitsbehälter			
				1K-C-500001→; für Rechtslenker; +PR 1ZA / 1ZE / 1AS / 1AT	24.4153-0202.3	011027	ATE Ø 23,8 ohne Bremsflüssigkeitsbehälter			
				1K-9-900001→ 1K-C-500000; für Rechtslenker; +PR 1ZE / 1LJ / 1ZA	24.4153-0202.3	011027	ATE Ø 23,8 ohne Bremsflüssigkeitsbehälter			

	kw			 	! #		
VW - GOLF PLUS Van (521) 01/09→08/14							
 Hauptbremszylinder							
1.4 TSi	90	01/09→08/14		1K-8-500001→; für Rechtslenker; → 1K-9-899999; +PR 1LJ		24.4153-0202.3 011027	ATE Ø 23,8 ohne Bremsflüssigkeitsbehälter
1.4 TSi	118	01/09→09/12		1K-C-500001→; für Linkslenker; +PR 1ZF / 1AC		03.2122-2129.3 010799	ATE Ø 22,2
				1K-8-500001→ 1K-9-899999; für Linkslenker; +PR 1LK / 1ZA / 1ZC / 1ZD / 1ZE / 1ZF / 1ZM / 1ZP		03.2122-2129.3 010799	ATE Ø 22,2
				1K-9-900001→; für Linkslenker; → 1K-C-500000; +PR 1ZF		03.2122-2129.3 010799	ATE Ø 22,2
				1K-C-500001→; für Linkslenker; +PR 1ZA / 1ZE / 1AS / 1AT		03.2123-3449.3 010808	ATE Ø 23,8
				1K-8-500001→ 1K-9-899999; für Linkslenker; +PR 1LJ		03.2123-3449.3 010808	ATE Ø 23,8
				1K-9-900001→; für Linkslenker; → 1K-C-500000; +PR 1ZE / 1LJ / 1ZA		03.2123-3449.3 010808	ATE Ø 23,8
				1K-C-500001→; für Rechtslenker; +PR 1ZF / 1AC		24.4152-0132.3 011025	ATE Ø 22,2 ohne Bremsflüssigkeitsbehälter
				1K-9-900001→ 1K-C-500000; für Rechtslenker; +PR 1ZF		24.4152-0132.3 011025	ATE Ø 22,2 ohne Bremsflüssigkeitsbehälter
				1K-8-500001→; für Rechtslenker; → 1K-9-899999; +PR 1LK / 1ZA / 1ZC / 1ZD / 1ZE / 1ZF / 1ZM / 1ZP		24.4152-0132.3 011025	ATE Ø 22,2 ohne Bremsflüssigkeitsbehälter
				1K-C-500001→; für Rechtslenker; +PR 1ZA / 1ZE / 1AS / 1AT		24.4153-0202.3 011027	ATE Ø 23,8 ohne Bremsflüssigkeitsbehälter
				1K-8-500001→; für Rechtslenker; → 1K-9-899999; +PR 1LJ		24.4153-0202.3 011027	ATE Ø 23,8 ohne Bremsflüssigkeitsbehälter
				1K-9-900001→ 1K-C-500000; für Rechtslenker; +PR 1ZE / 1LJ / 1ZA		24.4153-0202.3 011027	ATE Ø 23,8 ohne Bremsflüssigkeitsbehälter
2.0 TDi	103	11/09→08/14		1K-C-500001→; für Linkslenker; +PR 1ZF / 1AC		03.2122-2129.3 010799	ATE Ø 22,2
				für Linkslenker; → 1K-6-565000		03.2122-2129.3 010799	ATE Ø 22,2
				1K-9-900001→; für Linkslenker; → 1K-C-500000; +PR 1ZF		03.2122-2129.3 010799	ATE Ø 22,2
				1K-6-565001→; für Linkslenker; → 1K-8-500000; +PR 1AC / 1AT / 1AS		03.2122-2129.3 010799	ATE Ø 22,2
				1K-8-500001→ 1K-9-899999; für Linkslenker; +PR 1LK / 1ZA / 1ZC / 1ZD / 1ZE / 1ZF / 1ZM / 1ZP		03.2122-2129.3 010799	ATE Ø 22,2
				1K-C-500001→; für Linkslenker; +PR 1ZA / 1ZE / 1AS / 1AT		03.2123-3449.3 010808	ATE Ø 23,8
				1K-8-500001→ 1K-9-899999; für Linkslenker; +PR 1LJ		03.2123-3449.3 010808	ATE Ø 23,8
				1K-6-565001→; für Linkslenker; → 1K-8-500000; +PR 1LJ		03.2123-3449.3 010808	ATE Ø 23,8
				1K-9-900001→; für Linkslenker; → 1K-C-500000; +PR 1ZE / 1LJ / 1ZA		03.2123-3449.3 010808	ATE Ø 23,8
				für Rechtslenker; → 1K-6-565000		24.2122-1981.3 011024	ATE Ø 22,2 ohne Bremsflüssigkeitsbehälter
				1K-C-500001→; für Rechtslenker; +PR 1ZF / 1AC		24.4152-0132.3 011025	ATE Ø 22,2 ohne Bremsflüssigkeitsbehälter
				1K-9-900001→ 1K-C-500000; für Rechtslenker; +PR 1ZF		24.4152-0132.3 011025	ATE Ø 22,2 ohne Bremsflüssigkeitsbehälter
				1K-8-500001→; für Rechtslenker; → 1K-9-899999; +PR 1LK / 1ZA / 1ZC / 1ZD / 1ZE / 1ZF / 1ZM / 1ZP		24.4152-0132.3 011025	ATE Ø 22,2 ohne Bremsflüssigkeitsbehälter
				1K-6-565001→; für Rechtslenker; → 1K-8-500000; +PR 1AC / 1AT / 1AS		24.4152-0132.3 011025	ATE Ø 22,2 ohne Bremsflüssigkeitsbehälter
				1K-9-900001→ 1K-C-500000; für Rechtslenker; +PR 1ZE / 1LJ / 1ZA		24.4153-0202.3 011027	ATE Ø 23,8 ohne Bremsflüssigkeitsbehälter
				1K-8-500001→; für Rechtslenker; → 1K-9-899999; +PR 1LJ		24.4153-0202.3 011027	ATE Ø 23,8 ohne Bremsflüssigkeitsbehälter
	1K-C-500001→; für Rechtslenker; +PR 1ZA / 1ZE / 1AS / 1AT		24.4153-0202.3 011027	ATE Ø 23,8 ohne Bremsflüssigkeitsbehälter			
Drucksensor, Bremskraftverstärker							
1.4 TSi	90 - 118	01/09→08/14		1K-6-565001→ 1K-9-899999; für Rechtslenker; +PR 1AS		03.0655-0101.2 370008	ATE
2.0 TDi	103	11/09→08/14		+PR 1AS; für Linkslenker; → 1K-9-899999		03.0655-0101.2 370008	ATE

	kw					! #		
VW - GOLF SPORTSVAN VII (AM1, AN1) 02/14→08/20								
 Hauptbremszylinder								
1.0 TSI	63 - 85	05/15→08/20			für Linkslenker		24.4123-1719.3 011017	TRW Ø 23,8 ohne Bremsflüssigkeitsbehälter
1.2 TSI	63 - 81	04/14→11/17					24.4153-1522.3 011048	ATE Ø 23,8 ohne Bremsflüssigkeitsbehälter
1.4 TSI	92	04/14→08/20						
1.4 TSI MultiFuel	92	04/14→11/17						
1.5 TSI	96 - 110	05/17→08/20						
1.6	81	05/14→11/16						
1.6 TDI	66 - 85	02/14→08/20						
2.0 TDI	81	05/14→11/17						
1.4 TSI	110	02/14→07/18			05/14→; für Linkslenker		24.4123-1719.3 011017	TRW Ø 23,8 ohne Bremsflüssigkeitsbehälter
1.6 TDI	81	02/14→11/16						
2.0 TDI	110	02/14→08/20			für Linkslenker		24.4153-1522.3 011048	ATE Ø 23,8 ohne Bremsflüssigkeitsbehälter
VW - GOLF VAN IV Variant (1J5) 05/99→06/06								
 Bremskraftverstärker								
1.4	55	05/00→06/06			09/00→ 10/01; für Linkslenker; +PR 1AT		03.7860-0602.4 300141	ATE Ø 10" pneumatisch
1.6	77	05/00→06/06			→ 08/00; für Linkslenker; +PR 1AT		03.7863-0402.4 300124	ATE Ø 10" pneumatisch
1.9 SDI	50	05/99→05/06			11/01→ 10/03; für Linkslenker; +PR 1AT		03.7863-3502.4 300128	ATE Ø 10" pneumatisch
1.9 TDI	81	05/99→05/06						
1.9 TDI	66	05/99→05/06			09/00→ 10/01; für Linkslenker; +PR 1AT		03.7860-0602.4 300141	ATE Ø 10" pneumatisch
					→ 08/00; für Linkslenker; +PR 1AT		03.7863-0402.4 300124	ATE Ø 10" pneumatisch
					11/01→; für Linkslenker; +PR 1AT		03.7863-3502.4 300128	ATE Ø 10" pneumatisch
1.9 TDI	74	02/00→06/06			→ 10/01; für Linkslenker; +PR 1AT		03.7860-0602.4 300141	ATE Ø 10" pneumatisch
					11/01→; für Linkslenker; +PR 1AT		03.7863-3502.4 300128	ATE Ø 10" pneumatisch
1.9 TDI	85	05/99→04/02			09/00→; für Linkslenker; +PR 1AT		03.7860-0602.4 300141	ATE Ø 10" pneumatisch
					→ 08/00; für Linkslenker; +PR 1AT		03.7863-0402.4 300124	ATE Ø 10" pneumatisch
1.9 TDI	96	04/01→05/06			→ 10/01; für Linkslenker; +PR 1AT		03.7860-0602.4 300141	ATE Ø 10" pneumatisch
					11/01→ 10/03; für Linkslenker; +PR 1AT		03.7863-3502.4 300128	ATE Ø 10" pneumatisch
 Hauptbremszylinder								
1.4	55	05/00→06/06			→ 08/00; für Linkslenker; +PR 1AT		03.2123-2024.3 010597	ATE Ø 23,8
1.6	77	05/00→06/06			09/00→ 10/03; für Linkslenker; +PR 1AT		03.2123-2715.3 010802	ATE Ø 23,8
1.9 SDI	50	05/99→05/06						
1.9 TDI	81	05/99→05/06			09/00→ 10/03; für Rechtslenker; +PR 1AT		03.2123-2774.3 010803	ATE Ø 23,8
					→ 10/03; für Linkslenker; +PR 1AM / 1AC / 1AH / 1AJ		24.2123-1709.3 010503	Ø 23,8
1.9 TDI	66 - 85	05/99→05/06			→ 08/00; für Linkslenker; +PR 1AT		03.2123-2024.3 010597	ATE Ø 23,8
					09/00→; für Linkslenker; +PR 1AT		03.2123-2715.3 010802	ATE Ø 23,8
					09/00→; für Rechtslenker; +PR 1AT		03.2123-2774.3 010803	ATE Ø 23,8
					für Linkslenker; +PR 1AM / 1AC / 1AH / 1AJ		24.2123-1709.3 010503	Ø 23,8
1.9 TDI	74	02/00→06/06			für Linkslenker; +PR 1AT		03.2123-2715.3 010802	ATE Ø 23,8
					für Rechtslenker; +PR 1AT		03.2123-2774.3 010803	ATE Ø 23,8
					für Linkslenker; +PR 1AM / 1AC / 1AH / 1AJ		24.2123-1709.3 010503	Ø 23,8
1.9 TDI	96	04/01→05/06			→ 10/03; für Linkslenker; +PR 1AT		03.2123-2715.3 010802	ATE Ø 23,8
					→ 10/03; für Rechtslenker; +PR 1AT		03.2123-2774.3 010803	ATE Ø 23,8
					→ 10/03; für Linkslenker; +PR 1AM / 1AC / 1AH / 1AJ		24.2123-1709.3 010503	Ø 23,8
VW - GOLF VAN VI Variant (AJ5) 07/09→05/14								
 Bremskraftverstärker								
1.2 TSi	77	09/09→05/14			12/09→; +PR 1AC / 1AT / 1ZA / 1LL / 1LJ / 1ZE; für Rechtslenker		03.7848-9802.4 300344	ATE Ø 7 / 8" pneumatisch
1.4 TSi	118	07/09→10/12						
1.6 TDi BlueMotion	77	07/09→05/14			1K-9-400001→; → 11/10; für Linkslenker; +PR 1ZK		03.7860-8802.4 300291	ATE Ø 10" pneumatisch
2.0 TDi	103	07/09→05/14						
					12/09→; für Linkslenker; +PR 1ZD / 1ZP		03.7863-3232.4 300307	ATE Ø 10" pneumatisch
					+PR 1AC / 1AT; → 11/09; für Linkslenker		03.7863-3332.4 300308	ATE Ø 10" pneumatisch
1.4 TSi	90	07/09→05/14			12/09→; +PR 1AC / 1AT / 1ZA / 1LL / 1LJ / 1ZE; für Rechtslenker		03.7848-9802.4 300344	ATE Ø 7 / 8" pneumatisch
					12/09→; für Linkslenker; +PR 1ZD / 1ZP		03.7863-3232.4 300307	ATE Ø 10" pneumatisch
					+PR 1AC / 1AT; → 11/09; für Linkslenker		03.7863-3332.4 300308	ATE Ø 10" pneumatisch
1.6 TDi	66	12/09→10/12			+PR 1AC / 1AT / 1ZA / 1LL / 1LJ / 1ZE; für Rechtslenker		03.7848-9802.4 300344	ATE Ø 7 / 8" pneumatisch
→								

	kw			 	! #		
VW - GOLF VAN VI Variant (AJ5) 07/09→05/14							
 Bremskraftverstärker							
1.6 TDi	66	12/09→10/12		1K-9-400001→; → 11/10; für Linkslenker; +PR 1ZK	03.7860-8802.4	300291	ATE Ø 10" pneumatisch
				für Linkslenker; +PR 1ZD / 1ZP	03.7863-3232.4	300307	ATE Ø 10" pneumatisch
				+PR 1AC / 1AT; für Linkslenker	03.7863-3332.4	300308	ATE Ø 10" pneumatisch
 Hauptbremszylinder							
1.2 TSi 1.4 TSi	77 90 - 118	09/09→05/14 07/09→05/14		12/09→; für Linkslenker; +PR 1ZD / 1ZP	03.2122-2129.3	010799	ATE Ø 22,2
1.6 TDi BlueMotion 2.0 TDi	77 103	07/09→05/14 07/09→05/14		→ 11/09; für Linkslenker; +PR 1AC / 1AT	03.2122-2129.3	010799	ATE Ø 22,2
				→ 11/09; +PR 1LJ / 1LL	03.2123-3449.3	010808	ATE Ø 23,8
				→ 11/09; für Rechtslenker	24.4152-0132.3	011025	ATE Ø 22,2 ohne Bremsflüssigkeitsbehälter
				12/09→; +PR 1ZD / 1ZP; für Rechtslenker	24.4152-0132.3	011025	ATE Ø 22,2 ohne Bremsflüssigkeitsbehälter
				→ 11/09; +PR 1LJ / 1LL; für Rechtslenker	24.4153-0202.3	011027	ATE Ø 23,8 ohne Bremsflüssigkeitsbehälter
				12/09→; +PR 1LJ / 1ZA / 1ZE; für Rechtslenker	24.4153-0202.3	011027	ATE Ø 23,8 ohne Bremsflüssigkeitsbehälter
1.6 TDi	66	12/09→10/12		für Linkslenker; +PR 1ZD / 1ZP / 1AC / 1AT	03.2122-2129.3	010799	ATE Ø 22,2
				für Linkslenker; +PR 1ZD / 1ZP	24.2122-1788.3	011145	FTE Ø 22,2 ohne Bremsflüssigkeitsbehälter
				+PR 1ZD / 1ZP; für Rechtslenker	24.4152-0132.3	011025	ATE Ø 22,2 ohne Bremsflüssigkeitsbehälter
				+PR 1LJ / 1ZA / 1ZE; für Rechtslenker	24.4153-0202.3	011027	ATE Ø 23,8 ohne Bremsflüssigkeitsbehälter
VW - GOLF VAN VII Variant (BA5) 04/13→03/17							
 Hauptbremszylinder							
1.2 TSi BlueMotion 1.4 TSi BlueMotion 1.6 TDi BlueMotion 1.6 TDi BlueMotion 4motion 2.0 TDi BlueMotion 2.0 TDi BlueMotion 4motion	63 - 77 90 - 103 66 - 81 77 110 110	04/13→03/17 05/13→03/17 05/13→03/17 05/13→03/17 04/13→03/17 04/13→03/17		für Linkslenker; +PR 1ZA / 1ZD / 1ZE / 1ZF / 1ZP	03.4153-5403.3	010994	ATE Ø 23,8
					24.4123-1719.3	011017	TRW Ø 23,8 ohne Bremsflüssigkeitsbehälter
VW - JETTA III (1K2) 09/04→12/13							
 Hauptbremszylinder							
1.4 TSi 1.6 FSI 1.6 MultiFuel 1.6 TDi 1.9 TDi 2.0 FSI 2.0 TDi 2.0 TDi 16V 2.0 TFSI 2.5	90 - 125 85 75 66 - 77 74 - 77 110 100 - 125 103 147 125	07/06→10/10 09/05→10/10 01/08→10/10 06/09→10/10 08/05→10/10 08/05→10/10 09/05→10/10 08/05→10/10 10/05→10/10 07/08→10/10		für Linkslenker; +PR 1AS	03.2122-2129.3	010799	ATE Ø 22,2
				für Linkslenker; +PR 1AC / 1AT	24.2122-1788.3	011145	FTE Ø 22,2 ohne Bremsflüssigkeitsbehälter
				für Rechtslenker	24.2122-1981.3	011024	ATE Ø 22,2 ohne Bremsflüssigkeitsbehälter
1.6	75	09/04→10/10		für Linkslenker; +PR 1AS	03.2122-2129.3	010799	ATE Ø 22,2
				08/05→; für Linkslenker; +PR 1AC / 1AT	24.2122-1788.3	011145	FTE Ø 22,2 ohne Bremsflüssigkeitsbehälter
				für Rechtslenker	24.2122-1981.3	011024	ATE Ø 22,2 ohne Bremsflüssigkeitsbehälter
2.5	110	01/06→10/10		07/08→; für Linkslenker; +PR 1AS	03.2122-2129.3	010799	ATE Ø 22,2
				07/08→; für Linkslenker; +PR 1AC / 1AT	24.2122-1788.3	011145	FTE Ø 22,2 ohne Bremsflüssigkeitsbehälter
				07/08→; für Rechtslenker	24.2122-1981.3	011024	ATE Ø 22,2 ohne Bremsflüssigkeitsbehälter
→							

VW - JETTA III (1K2) 09/04→12/13

Drucksensor, Bremskraftverstärker

1.4 TSI	90 - 125	07/06→10/10		für Linkslenker; +PR 1AS			ATE			
1.6	75	09/04→10/10								
1.6 FSI	85	09/05→10/10								
1.6 MultiFuel	75	01/08→10/10								
1.6 TDI	66 - 77	06/09→10/10								
1.9 TDI	74 - 77	08/05→10/10								
2.0 FSI	110	08/05→10/10								
2.0 TDI	100 - 125	09/05→10/10								
2.0 TDI 16V	103	08/05→10/10								
2.0 TFSI	147	10/05→10/10								
2.5	125	07/08→10/10								
2.5	110	01/06→10/10		07/08→; für Linkslenker; +PR 1AS						ATE













VW - JETTA IV (162, 163, AV3, AV2) 01/08→12/19











Bremskraftverstärker







1.2 TSI	77	10/10→12/17		04/11→; für Rechtslenker; + ESP			ATE Ø 7 / 8" pneumatisch			
1.6 TDI	77	04/10→07/15								
2.0 TDI	103	02/11→12/17								
1.2 TSI 16V	77	08/14→12/17		für Rechtslenker; + ESP						
1.4 TSI	90 - 118	04/11→12/17								
1.4 TSI Hybrid	125	04/11→12/17								
1.6	63 - 81	12/11→04/18								
1.6 MPi	66	09/15→04/18								
1.8 TSI	125	07/14→12/17								
2.0	85	06/10→12/17								
2.0 TDI	81	10/10→12/17								
2.0 TDI	110	07/14→12/17		08/14→; für Rechtslenker; + ESP						ATE Ø 7 / 8" pneumatisch
2.0 TFSI	147	12/10→07/14		04/11→; für Rechtslenker; + ESP						ATE Ø 7 / 8" pneumatisch
2.5	125	04/10→12/17		04/11→; für Linkslenker; - ESP						ATE Ø 10" pneumatisch
2.0 TSI	155	12/12→12/17		für Rechtslenker; + ESP						ATE Ø 7 / 8" pneumatisch
				für Linkslenker; - ESP			ATE Ø 10" pneumatisch			











Hauptbremszylinder

1.2 TSI	77	10/10→12/17		03/12→; für Linkslenker			FTE Ø 22,2 ohne Bremsflüssigkeitsbehälter			
2.0 TFSI	147	12/10→07/14								
2.5	125	04/10→12/17		04/11→; für Linkslenker; - ESP						FTE Ø 22,2 ohne Bremsflüssigkeitsbehälter
				04/11→; für Rechtslenker; +PR 1AT / 1AS						ATE Ø 22,2 ohne Bremsflüssigkeitsbehälter
				04/11→; für Rechtslenker; +PR 1AC						ATE Ø 23,8 ohne Bremsflüssigkeitsbehälter
1.2 TSI 16V	77	08/14→12/17		für Linkslenker			FTE Ø 22,2 ohne Bremsflüssigkeitsbehälter			
1.4 TSI	90 - 118	04/11→12/17								
1.6	63 - 81	03/13→04/18		für Linkslenker; - ESP						FTE Ø 22,2 ohne Bremsflüssigkeitsbehälter
1.6 MPi	66	09/15→04/18		für Rechtslenker; +PR 1AT / 1AS						ATE Ø 22,2 ohne Bremsflüssigkeitsbehälter
2.0	85	06/10→12/17								ATE Ø 23,8 ohne Bremsflüssigkeitsbehälter
2.0 TDI	81	10/10→12/17		für Rechtslenker; +PR 1AC			ATE Ø 23,8 ohne Bremsflüssigkeitsbehälter			
2.0 TSI	155	12/12→12/17								
1.4 TSI	92 - 110	08/14→12/17		für Linkslenker						FTE Ø 22,2 ohne Bremsflüssigkeitsbehälter
1.8 TSI	125	07/14→12/17		für Rechtslenker; +PR 1AT / 1AS						ATE Ø 22,2 ohne Bremsflüssigkeitsbehälter
				für Rechtslenker; +PR 1AC						ATE Ø 23,8 ohne Bremsflüssigkeitsbehälter
1.4 TSI Hybrid	125	04/11→12/17		für Rechtslenker; +PR 1AT / 1AS			ATE Ø 22,2 ohne Bremsflüssigkeitsbehälter			
				für Rechtslenker; +PR 1AC			ATE Ø 23,8 ohne Bremsflüssigkeitsbehälter			
1.6	77	12/11→04/18		03/12→; für Linkslenker			FTE Ø 22,2 ohne Bremsflüssigkeitsbehälter			
				für Linkslenker; - ESP			FTE Ø 22,2 ohne Bremsflüssigkeitsbehälter			
				für Rechtslenker; +PR 1AT / 1AS			ATE Ø 22,2 ohne Bremsflüssigkeitsbehälter			
				für Rechtslenker; +PR 1AC			ATE Ø 23,8 ohne Bremsflüssigkeitsbehälter			













	kw					! #		
VW - JETTA IV (162, 163, AV3, AV2) 01/08→12/19								
 Hauptbremszylinder								
1.6 TDI	77	04/10→07/15		03/12→; für Linkslenker	24.2122-1788.3	011145	FTE Ø 22,2 ohne Bremsflüssigkeitsbehälter	
				04/11→; für Linkslenker	24.2122-1788.3	011145	FTE Ø 22,2 ohne Bremsflüssigkeitsbehälter	
				04/11→; für Linkslenker; - ESP	24.2122-1788.3	011145	FTE Ø 22,2 ohne Bremsflüssigkeitsbehälter	
				04/11→; für Rechtslenker; +PR 1AT / 1AS	24.4152-0132.3	011025	ATE Ø 22,2 ohne Bremsflüssigkeitsbehälter	
			04/11→; für Rechtslenker; +PR 1AC	24.4153-0202.3	011027	ATE Ø 23,8 ohne Bremsflüssigkeitsbehälter		
2.0 TDI	103	02/11→12/17		04/11→; für Linkslenker	24.2122-1788.3	011145	FTE Ø 22,2 ohne Bremsflüssigkeitsbehälter	
				04/11→; für Linkslenker; - ESP	24.2122-1788.3	011145	FTE Ø 22,2 ohne Bremsflüssigkeitsbehälter	
				04/11→; für Rechtslenker; +PR 1AT / 1AS	24.4152-0132.3	011025	ATE Ø 22,2 ohne Bremsflüssigkeitsbehälter	
				04/11→; für Rechtslenker; +PR 1AC	24.4153-0202.3	011027	ATE Ø 23,8 ohne Bremsflüssigkeitsbehälter	
2.0 TDI	110	07/14→12/17		08/14→; für Linkslenker	24.2122-1788.3	011145	FTE Ø 22,2 ohne Bremsflüssigkeitsbehälter	
				für Rechtslenker; +PR 1AT / 1AS	24.4152-0132.3	011025	ATE Ø 22,2 ohne Bremsflüssigkeitsbehälter	
				für Rechtslenker; +PR 1AC	24.4153-0202.3	011027	ATE Ø 23,8 ohne Bremsflüssigkeitsbehälter	
VW - JETTA VII Stufenheck (BU3, BU4) 12/17→								
 Bremskraftverstärker								
1.4 TSI	110	12/17→		für Rechtslenker; + ESP	03.7848-9802.4	300344	ATE Ø 7 / 8" pneumatisch	
 Hauptbremszylinder								
1.4 TSI	110	12/17→		für Linkslenker	24.2122-1788.3	011145	FTE Ø 22,2 ohne Bremsflüssigkeitsbehälter	
				für Rechtslenker; +PR 1AT / 1AS	24.4152-0132.3	011025	ATE Ø 22,2 ohne Bremsflüssigkeitsbehälter	
				für Rechtslenker; +PR 1AC	24.4153-0202.3	011027	ATE Ø 23,8 ohne Bremsflüssigkeitsbehälter	
VW - LOAD UP (121, 122, BL1, BL2) 12/14→08/20								
 Hauptbremszylinder								
1.0	44	12/14→11/19		für Linkslenker	24.4120-1703.3	011015	TRW Ø 20,6 ohne Bremsflüssigkeitsbehälter	
1.0 BlueMotion	55	05/16→11/19						
1.0 EcoFuel	50	12/14→08/20						
1.0 TSi BlueMotion	66	05/16→09/18						
VW - LT 28-35 II Bus (2DB, 2DE, 2DK) 04/96→07/06								
 Hauptbremszylinder								
2.3	105	05/96→07/06		→ 2D-X-012290; + ABS	24.2123-1711.3	010518	Ø 23,8	
2.5 SDI	55	07/96→07/06		→ 2D-2-011024; + ABS	24.2123-1711.3	010518	Ø 23,8	
				→ 2D-2-011024; - ABS	24.2123-1728.3	010558	Ø 23,8	
				2D-2-011025→	24.2123-1755.3	010750	Ø 23,8	
				2D-X-012291→ 2D-2-011024; + ABS	24.2125-1727.3	010723	Ø 25,4	
				2D-2-011025→; + ABS	24.2125-1735.3	010879	TRW Ø 25,4	
2.5 TDI	61 - 80	05/99→07/06		→ 2D-2-011024; + ABS	24.2123-1711.3	010518	Ø 23,8	
2.8 TDI	96 - 116	01/99→06/06		→ 2D-2-011024; - ABS	24.2123-1728.3	010558	Ø 23,8	
				2D-2-011025→	24.2123-1755.3	010750	Ø 23,8	
VW - LT 28-46 II Kasten (2DA, 2DD, 2DH) 04/96→07/06								
 Hauptbremszylinder								
2.3	105	05/96→07/06		→ 2D-2-011024; + ABS	24.2123-1711.3	010518	Ø 23,8	
2.5 SDI	55	09/96→07/06		→ 2D-X-012290; + ABS	24.2123-1711.3	010518	Ø 23,8	
				→ 2D-2-011024; - ABS	24.2123-1728.3	010558	Ø 23,8	
2.5 TDI	61 - 80	05/99→07/06		→ 2D-2-011024; - ABS	24.2123-1728.3	010558	Ø 23,8	
				2D-2-011025→	24.2123-1755.3	010750	Ø 23,8	
2.8 TDI	92 - 116	07/97→07/06		2D-X-012291→ 2D-2-011024; + ABS	24.2125-1727.3	010723	Ø 25,4	
				2D-2-011025→; + ABS	24.2125-1735.3	010879	TRW Ø 25,4	

	kw					! #		
VW - LT 28-46 II Pritsche/Fahrgestell (2DC, 2DF, 2DG, 2DL, 2DM) 04/96→07/06								
 Hauptbremszylinder								
2.3	105	06/96→07/06		→ 2D-2-011024; + ABS		24.2123-1711.3	010518	Ø 23,8
2.5 SDI	55	09/96→07/06		→ 2D-X-012290; + ABS		24.2123-1711.3	010518	Ø 23,8
2.5 TDI	61 - 80	05/99→07/06		→ 2D-2-011024; - ABS		24.2123-1728.3	010558	Ø 23,8
2.8 TDI	92 - 116	07/97→07/06		2D-2-011025→		24.2123-1755.3	010750	Ø 23,8
				2D-X-012291→ 2D-2-011024; + ABS		24.2125-1727.3	010723	Ø 25,4
				2D-2-011025→; + ABS		24.2125-1735.3	010879	TRW Ø 25,4
VW - LUPO I (6X1, 6E1) 09/98→07/05								
 Hauptbremszylinder								
1.0	37	09/98→07/05		- ABS		03.2120-3943.3	010532	ATE Ø 20,6
1.2 TDI 3L	45	07/99→07/05		für Linkslenker; + ABS / - ESP		03.2122-1344.3	010593	ATE Ø 22,2
1.4	44	10/00→07/05						
1.4 TDI	55	01/99→07/05						
1.7 SDI	44	09/98→07/05						
1.4 16V	55	09/98→07/05		10/98→; - ABS		03.2120-3943.3	010532	ATE Ø 20,6
				10/98→; für Linkslenker; + ABS / - ESP		03.2122-1344.3	010593	ATE Ø 22,2
1.4 16V	74	08/99→07/05		für Linkslenker; + ABS / - ESP		03.2123-1824.3	010596	ATE Ø 23,8
1.4 FSI	77	02/01→07/05						
1.6 GTI	92	09/00→07/05						
VW - MULTIVAN T5 (7HM, 7HN, 7HF, 7EF, 7EM, 7EN) 04/03→03/16								
 Bremskraftverstärker								
1.9 TDI	62 - 77	04/03→11/09		+PR 1AJ / 1AE / 1AC / 1AR; → 7H-A-050000		03.7765-1002.4	300246	ATE Ø 10 / 9" pneumatisch
2.0	85	11/03→08/15		+PR 1AK; → 7H-A-050000		03.7868-3702.4	300208	ATE Ø 10 / 8" pneumatisch
2.0 BiTDI	132	09/09→08/15						
2.0 BiTDI 4motion	132	09/09→08/15						
2.0 TDI	62 - 103	09/09→08/15						
2.0 TDI 4motion	103	09/09→08/15						
2.5 TDI	96 - 128	04/03→11/09						
2.5 TDI 4motion	96 - 128	07/04→11/09						
VR6 3.2	173	02/04→12/09						
VR6 3.2 4motion	173	07/04→12/09						
Pedalwegsensor, Bremspedal								
1.9 TDI	62 - 77	04/03→11/09		+PR 1AT; → 7H-A-050000		03.0655-0006.2	370006	ATE
2.0	85	11/03→08/15				03.2126-3014.3	010811	ATE Ø 27
2.0 BiTDI	132	09/09→08/15						
2.0 BiTDI 4motion	132	09/09→08/15						
2.0 TDI	62 - 103	09/09→08/15						
2.0 TDI 4motion	103	09/09→08/15						
2.5 TDI	96 - 128	04/03→11/09						
2.5 TDI 4motion	96 - 128	07/04→11/09						
VR6 3.2	173	02/04→12/09						
VR6 3.2 4motion	173	07/04→12/09						
 Hauptbremszylinder								
1.9 TDI	62 - 77	04/03→11/09		→ 7H-A-050000		03.2126-3014.3	010811	ATE Ø 27
2.0	85	11/03→08/15		7H-6-000001→ 7H-6-200000; für Rechtslenker; +PR 1AT		03.2126-3014.3	010811	ATE Ø 27
VR6 3.2	173	02/04→12/09						
				7H-A-200001→		03.2126-3144.3	010941	ATE Ø 27
2.0 BiTDI	132	09/09→08/15		→ 7H-A-050000		03.2126-3014.3	010811	ATE Ø 27
2.0 BiTDI 4motion	132	09/09→08/15		7H-A-200001→		03.2126-3144.3	010941	ATE Ø 27
2.0 TDI	62 - 103	09/09→08/15						
2.0 TDI 4motion	100 - 103	09/09→08/15						
2.5 TDI	96 - 128	04/03→11/09						
2.5 TDI 4motion	96 - 128	07/04→11/09						
VR6 3.2 4motion	173	07/04→12/09						
2.0 TDI	84	05/11→08/15				03.2126-3144.3	010941	ATE Ø 27
2.0 TSI	110 - 150	05/11→08/15						
2.0 TSI 4motion	150	07/11→08/15						

	kw					! #		
VW - NEW BEETLE (9C1, 1C1) 01/98—07/12								
Bremskraftverstärker								
1.4	55	11/01→09/10		→ 9C-2-620000; für Linkslenker; + ESP		03.7860-0602.4	300141	ATE Ø 10" pneumatisch
				9C-2-620001→; für Linkslenker; + ESP; → 05/10		03.7863-3502.4	300128	ATE Ø 10" pneumatisch
1.6	74	10/99→09/00		9C-Y-613783→ 9C-2-620000; für Linkslenker; + ESP		03.7860-0602.4	300141	ATE Ø 10" pneumatisch
				11/99→; → 9C-Y-613782; für Linkslenker; + ESP		03.7863-0402.4	300124	ATE Ø 10" pneumatisch
				9C-2-620001→; für Linkslenker; + ESP		03.7863-3502.4	300128	ATE Ø 10" pneumatisch
1.6 1.8 T 1.9 TDI 2.0 2.5	75 110 74 85 110	06/00→09/10 10/99→09/10 02/01→09/10 01/98→09/10 07/05→09/10		9C-Y-613783→ 9C-2-620000; für Linkslenker; + ESP		03.7860-0602.4	300141	ATE Ø 10" pneumatisch
				→ 9C-Y-613782; für Linkslenker; + ESP		03.7863-0402.4	300124	ATE Ø 10" pneumatisch
				9C-2-620001→; für Linkslenker; + ESP; → 05/10		03.7863-3502.4	300128	ATE Ø 10" pneumatisch
1.8 T	132	11/01→06/05		→ 9C-2-620000; für Linkslenker; + ESP		03.7860-0602.4	300141	ATE Ø 10" pneumatisch
				9C-2-620001→; für Linkslenker; + ESP		03.7863-3502.4	300128	ATE Ø 10" pneumatisch
1.9 TDI	66	01/98→06/04		9C-Y-613783→; → 02/01; für Linkslenker; + ESP		03.7860-0602.4	300141	ATE Ø 10" pneumatisch
				→ 9C-Y-613782; für Linkslenker; + ESP		03.7863-0402.4	300124	ATE Ø 10" pneumatisch
1.9 TDI	77	07/05→09/10		für Linkslenker; + ESP; → 05/10		03.7863-3502.4	300128	ATE Ø 10" pneumatisch
2.3 V5	125	10/00→09/10		9C-Y-613783→ 9C-2-620000; für Linkslenker; + ESP		03.7860-0602.4	300141	ATE Ø 10" pneumatisch
				→ 9C-Y-613782; für Linkslenker; + ESP		03.7863-0402.4	300124	ATE Ø 10" pneumatisch
				9C-2-620001→; für Linkslenker; + ESP; → 05/05		03.7863-3502.4	300128	ATE Ø 10" pneumatisch
3.2 RSI 4motion	165	04/00→05/01		9C-Y-613783→ 9C-2-620000; für Linkslenker; + ESP		03.7860-0602.4	300141	ATE Ø 10" pneumatisch
				→ 9C-Y-613782; für Linkslenker; + ESP		03.7863-0402.4	300124	ATE Ø 10" pneumatisch
				9C-2-620001→; für Linkslenker; + ESP		03.7863-3502.4	300128	ATE Ø 10" pneumatisch
Hauptbremszylinder								
1.4	55	11/01→09/10		→ 05/10; + ESP; für Linkslenker		03.2123-2715.3	010802	ATE Ø 23,8
				→ 9C-7-557428; + ESP; für Rechtslenker		03.2123-2774.3	010803	ATE Ø 23,8
				9C-7-557429→; für Rechtslenker; + ESP; → 05/10		03.2123-2774.3	010803	ATE Ø 23,8
				für Linkslenker; - ESP; → 06/05		24.2123-1709.3	010503	Ø 23,8
				07/05→; für Linkslenker; - ESP; → 05/10		24.2123-1783.3	011132	FTE Ø 23,8 ohne Bremsflüssigkeitsbehälter
1.6	74	10/99→09/00		11/99→; → 9C-Y-613782; für Linkslenker; + ESP		03.2123-2024.3	010597	ATE Ø 23,8
				9C-Y-613783→; für Linkslenker; + ESP		03.2123-2715.3	010802	ATE Ø 23,8
				9C-Y-613783→; für Rechtslenker; + ESP; → 9C-7-557428		03.2123-2774.3	010803	ATE Ø 23,8
				9C-7-557429→; für Rechtslenker; + ESP		03.2123-2774.3	010803	ATE Ø 23,8
				11/99→; für Linkslenker; - ESP		24.2123-1709.3	010503	Ø 23,8
1.6 1.8 T 1.9 TDI 2.0	75 110 74 85	06/00→09/10 10/99→09/10 02/01→09/10 01/98→09/10		→ 9C-Y-613782; für Linkslenker; + ESP		03.2123-2024.3	010597	ATE Ø 23,8
				9C-Y-613783→; für Linkslenker; + ESP; → 05/10		03.2123-2715.3	010802	ATE Ø 23,8
				9C-Y-613783→; für Rechtslenker; + ESP; → 9C-7-557428		03.2123-2774.3	010803	ATE Ø 23,8
				9C-7-557429→; für Rechtslenker; + ESP; → 05/10		03.2123-2774.3	010803	ATE Ø 23,8
				für Linkslenker; - ESP; → 06/05		24.2123-1709.3	010503	Ø 23,8
				07/05→; für Linkslenker; - ESP; → 05/10		24.2123-1783.3	011132	FTE Ø 23,8 ohne Bremsflüssigkeitsbehälter
1.8 T	132	11/01→06/05		für Linkslenker; + ESP		03.2123-2715.3	010802	ATE Ø 23,8
				für Rechtslenker; + ESP		03.2123-2774.3	010803	ATE Ø 23,8
				für Linkslenker; - ESP		24.2123-1709.3	010503	Ø 23,8
1.9 TDI	66	01/98→06/04		→ 9C-Y-613782; für Linkslenker; + ESP		03.2123-2024.3	010597	ATE Ø 23,8
				9C-Y-613783→; → 02/01; für Linkslenker; + ESP		03.2123-2715.3	010802	ATE Ø 23,8
				9C-Y-613783→; → 02/01; für Rechtslenker; + ESP		03.2123-2774.3	010803	ATE Ø 23,8
				→ 02/01; für Linkslenker; - ESP		24.2123-1709.3	010503	Ø 23,8
1.9 TDI	77	07/05→09/10		→ 05/10; + ESP; für Linkslenker		03.2123-2715.3	010802	ATE Ø 23,8
				9C-7-557429→; für Rechtslenker; + ESP; → 05/10		03.2123-2774.3	010803	ATE Ø 23,8
				→ 9C-7-557428; + ESP; für Rechtslenker		03.2123-2774.3	010803	ATE Ø 23,8

	kw					! #		
VW - NEW BEETLE (9C1, 1C1) 01/98—07/12								
 Hauptbremszylinder								
1.9 TDI	77	07/05→09/10		→ 05/10; - ESP; für Linkslenker		24.2123-1783.3	011132	FTE Ø 23,8 ohne Bremsflüssigkeitsbehälter
2.3 V5	125	10/00→09/10		→ 9C-Y-613782; für Linkslenker; + ESP		03.2123-2024.3	010597	ATE Ø 23,8
				9C-Y-613783→; für Linkslenker; + ESP; → 12/05		03.2123-2715.3	010802	ATE Ø 23,8
				9C-Y-613783→; für Rechtslenker; + ESP; → 12/05		03.2123-2774.3	010803	ATE Ø 23,8
2.5	110	07/05→09/10		für Linkslenker; - ESP; → 05/05		24.2123-1709.3	010503	Ø 23,8
				→ 9C-Y-613782; für Linkslenker; + ESP		03.2123-2024.3	010597	ATE Ø 23,8
				9C-Y-613783→; für Linkslenker; + ESP; → 05/10		03.2123-2715.3	010802	ATE Ø 23,8
				9C-Y-613783→; für Rechtslenker; + ESP; → 9C-7-557428		03.2123-2774.3	010803	ATE Ø 23,8
				9C-7-557429→; für Rechtslenker; + ESP; → 05/10		03.2123-2774.3	010803	ATE Ø 23,8
				für Linkslenker; - ESP		24.2123-1709.3	010503	Ø 23,8
3.2 RSI 4motion	165	04/00→05/01		→ 05/10; - ESP; für Linkslenker		24.2123-1783.3	011132	FTE Ø 23,8 ohne Bremsflüssigkeitsbehälter
				→ 9C-Y-613782; für Linkslenker; + ESP		03.2123-2024.3	010597	ATE Ø 23,8
				9C-Y-613783→; für Linkslenker; + ESP		03.2123-2715.3	010802	ATE Ø 23,8
				9C-Y-613783→; für Rechtslenker; + ESP		03.2123-2774.3	010803	ATE Ø 23,8
				für Linkslenker; - ESP		24.2123-1709.3	010503	Ø 23,8
VW - NEW BEETLE Cabriolet (1Y7) 09/02—07/12								
 Bremskraftverstärker								
1.4	55	01/03→09/10		+ ESP; für Linkslenker; → 05/10		03.7863-3502.4	300128	ATE Ø 10" pneumatisch
1.6	75	01/03→09/10						
1.9 TDI	77	07/05→09/10						
2.5	110	07/05→09/10						
1.8 T	110	01/03→09/10		12/03→; für Linkslenker; + ESP; → 05/10		03.7863-3502.4	300128	ATE Ø 10" pneumatisch
1.9 TDI	74	06/03→07/05		07/03→; für Linkslenker; + ESP		03.7863-3502.4	300128	ATE Ø 10" pneumatisch
2.0	85	09/02→10/10		01/03→; für Linkslenker; + ESP; → 05/10		03.7863-3502.4	300128	ATE Ø 10" pneumatisch
 Hauptbremszylinder								
1.4	55	01/03→09/10		→ 05/10; + ESP; für Linkslenker		03.2123-2715.3	010802	ATE Ø 23,8
1.6	75	01/03→09/10		→ 1Y-7-413420; für Rechtslenker; + ESP		03.2123-2774.3	010803	ATE Ø 23,8
				1Y-7-413421→; → 05/10; für Rechtslenker; + ESP		03.2123-2774.3	010803	ATE Ø 23,8
				für Linkslenker; - ESP; → 06/05		24.2123-1709.3	010503	Ø 23,8
				07/05→; für Linkslenker; - ESP; → 05/10		24.2123-1783.3	011132	FTE Ø 23,8 ohne Bremsflüssigkeitsbehälter
1.8 T	110	01/03→09/10		12/03→; für Linkslenker; + ESP; → 05/10		03.2123-2715.3	010802	ATE Ø 23,8
				12/03→; für Rechtslenker; + ESP; → 1Y-7-413420		03.2123-2774.3	010803	ATE Ø 23,8
				1Y-7-413421→; → 05/10; für Rechtslenker; + ESP		03.2123-2774.3	010803	ATE Ø 23,8
				12/03→; für Linkslenker; - ESP; → 06/05		24.2123-1709.3	010503	Ø 23,8
				07/05→; für Linkslenker; - ESP; → 05/10		24.2123-1783.3	011132	FTE Ø 23,8 ohne Bremsflüssigkeitsbehälter
				07/03→; für Linkslenker; + ESP		03.2123-2715.3	010802	ATE Ø 23,8
				1Y-7-413421→; für Rechtslenker; + ESP		03.2123-2774.3	010803	ATE Ø 23,8
1.9 TDI	74	06/03→07/05		07/03→; für Rechtslenker; + ESP; → 1Y-7-413420		03.2123-2774.3	010803	ATE Ø 23,8
				07/03→; für Linkslenker; - ESP; → 06/05		24.2123-1709.3	010503	Ø 23,8
				07/05→; für Linkslenker; - ESP		24.2123-1783.3	011132	FTE Ø 23,8 ohne Bremsflüssigkeitsbehälter
1.9 TDI 2.5	77 110	07/05→09/10 07/05→09/10		→ 05/10; + ESP; für Linkslenker		03.2123-2715.3	010802	ATE Ø 23,8
				1Y-7-413421→; → 05/10; für Rechtslenker; + ESP		03.2123-2774.3	010803	ATE Ø 23,8
				→ 1Y-7-413420; für Rechtslenker; + ESP		03.2123-2774.3	010803	ATE Ø 23,8
				→ 05/10; für Linkslenker; - ESP		24.2123-1783.3	011132	FTE Ø 23,8 ohne Bremsflüssigkeitsbehälter
				01/03→; für Linkslenker; + ESP; → 05/10		03.2123-2715.3	010802	ATE Ø 23,8
2.0	85	09/02→10/10		01/03→; für Rechtslenker; + ESP; → 1Y-7-413420		03.2123-2774.3	010803	ATE Ø 23,8
				1Y-7-413421→; → 05/10; für Rechtslenker; + ESP		03.2123-2774.3	010803	ATE Ø 23,8
				01/03→; für Linkslenker; - ESP; → 06/05		24.2123-1709.3	010503	Ø 23,8



	kw					! #		
VW - NEW BEETLE Cabriolet (1Y7) 09/02→07/12								
 Hauptbremszylinder								
2.0	85	09/02→10/10		07/05→; für Linkslenker; - ESP; → 05/10		24.2123-1783.3	011132	FTE Ø 23,8 ohne Bremsflüssigkeitsbehälter
VW - PASSAT ALLTRACK B7 (365) 01/12→12/14								
 Bremskraftverstärker								
1.8 TSI	112 - 118	01/12→12/14		für Rechtslenker; +PR 1LA / 1LB / 1ZM		03.7848-9802.4	300344	ATE Ø 7 / 8" pneumatisch
2.0 TDI	103	01/12→12/14		+PR 1ZG; für Linkslenker		03.7873-4402.4	300292	ATE Ø 11" pneumatisch
2.0 TDI 4motion	103 - 130	01/12→12/14		für Linkslenker; +PR 1LA / 1LB / 1ZM		03.7873-4502.4	300284	ATE Ø 11" pneumatisch
2.0 TSI 4motion	155	01/12→12/14						
 Hauptbremszylinder								
1.8 TSI	112 - 118	01/12→12/14		für Linkslenker; +PR 1ZG		03.4152-0116.3	010814	ATE Ø 22,2
2.0 TDI	103	01/12→12/14		für Linkslenker; +PR 1LA / 1LB / 1ZM		03.4153-0186.3	010816	ATE Ø 23,8
2.0 TDI 4motion	103 - 130	01/12→12/14		für Rechtslenker; +PR 1LA / 1LB / 1ZM		24.4153-0192.3	011026	ATE Ø 23,8 ohne Bremsflüssigkeitsbehälter
2.0 TSI 4motion	155	01/12→12/14						
VW - PASSAT ALLTRACK B8 Variant (3G5, CB5) 05/15→								
 Hauptbremszylinder								
1.4 TSI 4motion	110	05/15→		für Linkslenker; +PR 1ZA / 1ZD		24.4123-1719.3	011017	TRW Ø 23,8 ohne Bremsflüssigkeitsbehälter
2.0 TDI 4motion	110 - 176	05/15→				24.4153-1522.3	011048	ATE Ø 23,8 ohne Bremsflüssigkeitsbehälter
2.0 TSI 4motion	162 - 206	07/15→						
VW - PASSAT B5.5 (3B3) 10/00→12/05								
 Hauptbremszylinder								
1.6	75	11/00→05/05		05/02→		03.2125-0373.3	010810	ATE Ø 25,4
1.8 T	125	02/01→11/05		→ 3B-X-800000; - ESP		24.2123-1717.3	010521	Ø 23,8
1.8 T 20V	110	11/00→05/05		→ 3B-X-800000; + ESP		24.2123-1730.3	010620	Ø 23,8
2.3 V5	125	11/00→05/05						
2.3 V5 4motion	125	11/00→05/05		3B-Y-000001→ 3B-1-400000; für Linkslenker; - ESP		24.2125-1712.3	010622	Ø 25,4
2.5 TDI	110	11/00→05/05						
2.5 TDI 4motion	110	11/00→05/05		3B-Y-000001→ 3B-1-400000; für Linkslenker; + ESP		24.2125-1713.3	010623	Ø 25,4
2.8 4motion	140 - 142	10/00→05/05		3B-2-000001→		24.2125-1720.3	010688	TRW Ø 25,4
1.8 T 4motion	125	11/03→05/05		→ 3B-X-800000; - ESP		24.2123-1717.3	010521	Ø 23,8
				→ 3B-X-800000; + ESP		24.2123-1730.3	010620	Ø 23,8
1.9 TDI	74 - 96	11/00→05/05		05/02→		03.2125-0373.3	010810	ATE Ø 25,4
1.9 TDI 4motion	96	11/00→05/05		→ 3B-1-400000; für Linkslenker; - ESP		24.2125-1712.3	010622	Ø 25,4
2.0	85	11/00→05/05		→ 3B-1-400000; für Linkslenker; + ESP		24.2125-1713.3	010623	Ø 25,4
2.0 4motion	85	11/00→05/05		3B-2-000001→		24.2125-1720.3	010688	TRW Ø 25,4
2.0	96	11/01→05/05		05/02→		03.2125-0373.3	010810	ATE Ø 25,4
						24.2125-1720.3	010688	TRW Ø 25,4
2.0 TDI	100	12/03→05/05				03.2125-0373.3	010810	ATE Ø 25,4
						24.2125-1720.3	010688	TRW Ø 25,4
2.5 TDI	120	05/03→05/05				03.2125-0373.3	010810	ATE Ø 25,4
2.5 TDI 4motion	132	01/03→05/05		→ 3B-X-800000; - ESP		24.2123-1717.3	010521	Ø 23,8
2.8	140 - 142	10/00→05/05		→ 3B-X-800000; + ESP		24.2123-1730.3	010620	Ø 23,8
				3B-Y-000001→ 3B-1-400000; für Linkslenker; - ESP		24.2125-1712.3	010622	Ø 25,4
				3B-Y-000001→ 3B-1-400000; für Linkslenker; + ESP		24.2125-1713.3	010623	Ø 25,4
				3B-2-000001→		24.2125-1720.3	010688	TRW Ø 25,4
4.0 W8 4motion	202	09/01→09/04		05/02→		03.2125-0373.3	010810	ATE Ø 25,4
						24.2125-1720.3	010688	TRW Ø 25,4
VW - PASSAT B5.5 Variant (3B6) 09/00→08/05								
 Hauptbremszylinder								
1.6	75	11/00→05/05		05/02→		03.2125-0373.3	010810	ATE Ø 25,4
1.8 T 20V	110	11/00→05/05		→ 3B-X-800000; - ESP		24.2123-1717.3	010521	Ø 23,8
2.3 VR5	125	11/00→05/05		→ 3B-X-800000; + ESP		24.2123-1730.3	010620	Ø 23,8
2.3 VR5 4motion	125	11/00→05/05						
2.5 TDI	110	11/00→05/05		3B-Y-000001→ 3B-1-400000; für Linkslenker; - ESP		24.2125-1712.3	010622	Ø 25,4
2.5 TDI 4motion	110	11/00→05/05						
2.8 4motion	140 - 142	10/00→05/05		3B-Y-000001→ 3B-1-400000; für Linkslenker; + ESP		24.2125-1713.3	010623	Ø 25,4
				3B-2-000001→		24.2125-1720.3	010688	TRW Ø 25,4
→								

VW - PASSAT B5.5 Variant (3B6) 09/00→08/05

Hauptbremszylinder

1.6 1.8 T 20V 2.3 VR5 2.3 VR5 4motion 2.5 TDI 2.5 TDI 4motion 2.8 4motion	75 110 125 125 110 110 140 - 142	11/00→05/05 11/00→05/05 11/00→05/05 11/00→05/05 11/00→05/05 11/00→05/05 10/00→05/05		3B-2-000001→			24.2125-1720.3 010688	TRW Ø 25,4
1.8 4motion	125	11/03→05/05					03.2125-0373.3 010810	ATE Ø 25,4
				→ 3B-1-400000; für Linkslenker; - ESP			24.2125-1712.3 010622	Ø 25,4
				→ 3B-1-400000; für Linkslenker; + ESP			24.2125-1713.3 010623	Ø 25,4
				3B-2-000001→			24.2125-1720.3 010688	TRW Ø 25,4
1.8 T	125	05/02→08/05		→ 06/05			03.2125-0373.3 010810	ATE Ø 25,4
				→ 3B-X-800000; - ESP			24.2123-1717.3 010521	Ø 23,8
				→ 3B-X-800000; + ESP			24.2123-1730.3 010620	Ø 23,8
				3B-Y-000001→ 3B-1-400000; für Linkslenker; - ESP			24.2125-1712.3 010622	Ø 25,4
				3B-Y-000001→ 3B-1-400000; für Linkslenker; + ESP			24.2125-1713.3 010623	Ø 25,4
				3B-2-000001→; → 06/05			24.2125-1720.3 010688	TRW Ø 25,4
1.9 TDI	74 - 96	11/00→05/05		05/02→			03.2125-0373.3 010810	ATE Ø 25,4
1.9 TDI 4motion	96	11/00→05/05		→ 3B-1-400000; für Linkslenker; - ESP			24.2125-1712.3 010622	Ø 25,4
2.0	85	11/00→05/05		→ 3B-1-400000; für Linkslenker; + ESP			24.2125-1713.3 010623	Ø 25,4
2.0 4motion	85	11/00→05/05		3B-2-000001→			24.2125-1720.3 010688	TRW Ø 25,4
2.0	96	11/01→05/05		05/02→			03.2125-0373.3 010810	ATE Ø 25,4
							24.2125-1720.3 010688	TRW Ø 25,4
2.0 TDI	100	12/03→05/05					03.2125-0373.3 010810	ATE Ø 25,4
							24.2125-1720.3 010688	TRW Ø 25,4
2.5 TDI	120	05/03→05/05					03.2125-0373.3 010810	ATE Ø 25,4
2.5 TDI 4motion	132	01/03→05/05		→ 3B-X-800000; - ESP			24.2123-1717.3 010521	Ø 23,8
				→ 3B-X-800000; + ESP			24.2123-1730.3 010620	Ø 23,8
				3B-Y-000001→ 3B-1-400000; für Linkslenker; - ESP			24.2125-1712.3 010622	Ø 25,4
				3B-Y-000001→ 3B-1-400000; für Linkslenker; + ESP			24.2125-1713.3 010623	Ø 25,4
				3B-2-000001→			24.2125-1720.3 010688	TRW Ø 25,4
2.8	142	10/00→08/05		05/02→ 06/05			03.2125-0373.3 010810	ATE Ø 25,4
				→ 3B-X-800000; - ESP			24.2123-1717.3 010521	Ø 23,8
				→ 3B-X-800000; + ESP			24.2123-1730.3 010620	Ø 23,8
				3B-Y-000001→ 3B-1-400000; für Linkslenker; - ESP			24.2125-1712.3 010622	Ø 25,4
				3B-Y-000001→ 3B-1-400000; für Linkslenker; + ESP			24.2125-1713.3 010623	Ø 25,4
				3B-2-000001→; → 06/05			24.2125-1720.3 010688	TRW Ø 25,4
4.0 W8 4motion	202	09/01→09/04		05/02→			03.2125-0373.3 010810	ATE Ø 25,4
							24.2125-1720.3 010688	TRW Ø 25,4

VW - PASSAT B5 (3B2) 08/96→12/01

Hauptbremszylinder

1.6 1.8 T 1.9 TDI	74 110 81 - 85	10/96→11/00 10/96→11/00 10/96→11/00		→ 3B-X-800000; - ESP			24.2123-1717.3 010521	Ø 23,8
				→ 3B-X-800000; + ESP			24.2123-1730.3 010620	Ø 23,8
				3B-Y-000001→ 3B-1-400000; für Linkslenker; - ESP			24.2125-1712.3 010622	Ø 25,4
1.9 TDI 4motion	85	08/99→11/00						
1.9 TDI Syncro/4motion	81	06/97→08/00		3B-Y-000001→ 3B-1-400000; für Linkslenker; + ESP			24.2125-1713.3 010623	Ø 25,4
2.3 VR5	110	10/96→11/00						
2.3 VR5 Syncro/4motion	110	10/97→11/00						
2.5 TDI Syncro/4motion	110	12/98→11/00		3B-2-000001→			24.2125-1720.3 010688	TRW Ø 25,4
2.8 V6	140 - 142	08/96→11/00						
2.8 V6 4motion	140	09/99→11/00						
2.8 V6 Syncro/4motion	142	10/96→11/00						
1.8	85 - 92	10/96→11/00		→ 3B-X-800000; - ESP			24.2123-1717.3 010521	Ø 23,8
				→ 3B-X-800000; + ESP			24.2123-1730.3 010620	Ø 23,8
1.9 TDI	66	10/96→11/00		3B-Y-000001→; → 09/00; für Linkslenker; - ESP			24.2125-1712.3 010622	Ø 25,4
				3B-Y-000001→; → 09/00; für Linkslenker; + ESP			24.2125-1713.3 010623	Ø 25,4
1.8 Syncro/4motion →	92	12/96→08/00		→ 3B-X-800000; - ESP			24.2123-1717.3 010521	Ø 23,8

VW - PASSAT B5 (3B2) 08/96→12/01

Hauptbremszylinder

1.8 Syncro/4motion	92	12/96→08/00	→ 3B-X-800000; + ESP	24.2123-1730.3 010620	Ø 23,8
			3B-Y-000001→; für Linkslenker; - ESP	24.2125-1712.3 010622	Ø 25,4
			3B-Y-000001→; für Linkslenker; + ESP	24.2125-1713.3 010623	Ø 25,4
1.9 TDI 2.0 2.0 4motion	74 88 88	02/00→11/00 04/00→11/00 04/00→11/00	10/00→; → 3B-1-400000; für Linkslenker; - ESP	24.2125-1712.3 010622	Ø 25,4
			10/00→; → 3B-1-400000; für Linkslenker; + ESP	24.2125-1713.3 010623	Ø 25,4
2.5 TDI	110	07/98→11/00	08/98→; → 3B-X-800000; - ESP	24.2123-1717.3 010521	Ø 23,8
			08/98→; → 3B-X-800000; + ESP	24.2123-1730.3 010620	Ø 23,8
			3B-Y-000001→ 3B-1-400000; für Linkslenker; - ESP	24.2125-1712.3 010622	Ø 25,4
			3B-Y-000001→ 3B-1-400000; für Linkslenker; + ESP	24.2125-1713.3 010623	Ø 25,4
			3B-2-000001→	24.2125-1720.3 010688	TRW Ø 25,4

VW - PASSAT B5 Variant (3B5) 05/97→12/01











Hauptbremszylinder













1.6 1.8 T 1.9 TDI	74 110 81 -	06/97→11/00 05/97→11/00 06/97→11/00	→ 3B-X-800000; - ESP	24.2123-1717.3 010521	Ø 23,8
			→ 3B-X-800000; + ESP	24.2123-1730.3 010620	Ø 23,8
1.9 TDI 4motion	85 85	08/99→11/00	3B-Y-000001→ 3B-1-400000; für Linkslenker; - ESP	24.2125-1712.3 010622	Ø 25,4
			3B-Y-000001→ 3B-1-400000; für Linkslenker; + ESP	24.2125-1713.3 010623	Ø 25,4
2.3 VR5 2.3 VR5 Syncro/4motion	110 110	06/97→11/00 10/97→11/00	3B-2-000001→	24.2125-1720.3 010688	TRW Ø 25,4
2.5 TDI Syncro/4motion 2.8 V6	110 140	12/98→11/00 06/97→11/00			
2.8 V6 4motion 2.8 V6 Syncro/4motion	140 142	09/99→11/00 06/97→11/00			
1.8 1.8 Syncro/4motion 1.9 TDI	85 - 92 92	06/97→11/00 06/97→11/00 06/97→11/00	→ 3B-X-800000; - ESP	24.2123-1717.3 010521	Ø 23,8
			→ 3B-X-800000; + ESP	24.2123-1730.3 010620	Ø 23,8
	66		3B-Y-000001→; → 09/00; für Linkslenker; - ESP	24.2125-1712.3 010622	Ø 25,4
			3B-Y-000001→; → 09/00; für Linkslenker; + ESP	24.2125-1713.3 010623	Ø 25,4
1.9 TDI 2.0 2.0 4motion	74 88 88	02/00→11/00 04/00→11/00 04/00→11/00	10/00→; → 3B-1-400000; für Linkslenker; - ESP	24.2125-1712.3 010622	Ø 25,4
			10/00→; → 3B-1-400000; für Linkslenker; + ESP	24.2125-1713.3 010623	Ø 25,4
			3B-2-000001→	24.2125-1720.3 010688	TRW Ø 25,4
2.5 TDI	110	07/98→11/00	08/98→; → 3B-X-800000; - ESP	24.2123-1717.3 010521	Ø 23,8
			08/98→; → 3B-X-800000; + ESP	24.2123-1730.3 010620	Ø 23,8
			3B-Y-000001→ 3B-1-400000; für Linkslenker; - ESP	24.2125-1712.3 010622	Ø 25,4
			3B-Y-000001→ 3B-1-400000; für Linkslenker; + ESP	24.2125-1713.3 010623	Ø 25,4
			3B-2-000001→	24.2125-1720.3 010688	TRW Ø 25,4













VW - PASSAT B6 (3C2) 03/05→04/11











Bremskraftverstärker











1.4 TSI 1.8 TSI	90 118	05/07→07/10 05/07→07/10	10/07→; für Rechtslenker; - ESP	03.7848-9802.4 300344	ATE Ø 7 / 8" pneumatisch
			10/07→; für Linkslenker; - ESP	03.7873-4402.4 300292	ATE Ø 11" pneumatisch
1.4 TSI EcoFuel 1.6 1.6 FSI 1.6 TDI 1.8 TSI 1.9 TDI 2.0 BlueTDI 2.0 FSI	110 75 85 77 112 77 105 110 -	01/09→07/10 05/05→07/10 03/05→06/08 08/09→07/10 11/09→07/10 03/05→07/10 01/09→11/10 03/05→07/10	für Rechtslenker; - ESP	03.7848-9802.4 300344	ATE Ø 7 / 8" pneumatisch
			für Linkslenker; - ESP	03.7873-4402.4 300292	ATE Ø 11" pneumatisch
2.0 FSI 4motion 2.0 TDI	110 81 -	09/05→07/10 03/05→11/10			
2.0 TDI 16V 2.0 TDI 16V 4motion 2.0 TDI 4motion	103 103 103 -	03/05→07/10 03/05→08/10 03/05→07/10			
2.0 TFSI 3.2 FSI 4motion	147 184	07/05→07/10 11/05→07/10			
2.0 TDI	120	08/05→05/09	für Linkslenker; - ESP	03.7873-4402.4 300292	ATE Ø 11" pneumatisch











	kw					! #		
VW - PASSAT B6 (3C2) 03/05→04/11								
 Bremskraftverstärker								
3.6 R36 4motion	220	04/07→07/10			für Linkslenker		03.7873-4502.4 300284	ATE Ø 11" pneumatisch
 Hauptbremszylinder								
1.4 TSI	90	05/07→07/10			10/07→; +PR 1ZG; für Linkslenker		03.4152-0116.3 010814	ATE Ø 22,2
1.8 TSI	118	05/07→07/10			10/07→; für Linkslenker; +PR 1LJ / 1LK / 1LH / 1LM		03.4153-0186.3 010816	ATE Ø 23,8
					10/07→; für Rechtslenker; +PR 1LJ / 1LK / 1LH / 1LM		24.4153-0192.3 011026	ATE Ø 23,8 ohne Bremsflüssigkeitsbehälter
1.4 TSI EcoFuel	110	01/09→07/10			für Linkslenker; +PR 1ZG		03.4152-0116.3 010814	ATE Ø 22,2
1.6	75	05/05→07/10			für Linkslenker; +PR 1LJ / 1LK / 1LH / 1LM		03.4153-0186.3 010816	ATE Ø 23,8
1.6 FSI	85	03/05→06/08						
1.6 TDI	77	08/09→07/10						
1.8 TSI	112	11/09→07/10			für Rechtslenker; +PR 1LJ / 1LK / 1LH / 1LM		24.4153-0192.3 011026	ATE Ø 23,8 ohne Bremsflüssigkeitsbehälter
1.9 TDI	77	03/05→07/10						
2.0 BlueTDI	105	01/09→11/10						
2.0 FSI	110 - 125	03/05→07/10						
2.0 FSI 4motion	110	09/05→07/10						
2.0 TDI	81 - 125	03/05→11/10						
2.0 TDI 16V	103	03/05→07/10						
2.0 TDI 16V 4motion	103	03/05→08/10						
2.0 TDI 4motion	103 - 125	03/05→07/10						
2.0 TFSI	147	07/05→07/10						
3.2 FSI 4motion	184	11/05→07/10						
3.6 R36 4motion	220	04/07→07/10						
VW - PASSAT B6 Variant (3C5) 08/05→11/11								
 Bremskraftverstärker								
1.4 TSI	90	05/07→11/10			10/07→; +PR 1LJ; für Rechtslenker		03.7848-9802.4 300344	ATE Ø 7 / 8" pneumatisch
					10/07→; +PR 1LJ; für Linkslenker		03.7873-4502.4 300284	ATE Ø 11" pneumatisch
1.4 TSI EcoFuel	110	01/09→11/10			+PR 1LJ; für Rechtslenker		03.7848-9802.4 300344	ATE Ø 7 / 8" pneumatisch
					+PR 1LJ; für Linkslenker		03.7873-4502.4 300284	ATE Ø 11" pneumatisch
1.6	75	08/05→11/10			+PR 1LJ; für Rechtslenker		03.7848-9802.4 300344	ATE Ø 7 / 8" pneumatisch
1.6 FSI	85	08/05→06/08			+PR 1ZG; für Linkslenker		03.7873-4402.4 300292	ATE Ø 11" pneumatisch
1.6 TDI	77	08/09→11/10						
1.8 TSI	112	11/09→11/10			+PR 1LJ; für Linkslenker		03.7873-4502.4 300284	ATE Ø 11" pneumatisch
1.9 TDI	77	08/05→11/10						
2.0 BlueTDI	105	01/09→11/10						
2.0 FSI	110	08/05→11/10						
2.0 FSI 4motion	110	09/05→11/10						
2.0 TDI	81 - 125	08/05→11/10						
2.0 TDI 16V	103	08/05→11/10						
2.0 TDI 4motion	125	05/09→11/10						
2.0 TFSI	147	08/05→11/10						
3.2 FSI 4motion	184	11/05→11/10						
1.8 TSI	118	05/07→10/11			10/07→; +PR 1LJ; für Rechtslenker		03.7848-9802.4 300344	ATE Ø 7 / 8" pneumatisch
					10/07→; +PR 1ZG; für Linkslenker		03.7873-4402.4 300292	ATE Ø 11" pneumatisch
					10/07→; +PR 1LJ; für Linkslenker		03.7873-4502.4 300284	ATE Ø 11" pneumatisch
2.0 TDI 16V 4motion	103	08/05→11/10			09/05→; +PR 1LJ; für Rechtslenker		03.7848-9802.4 300344	ATE Ø 7 / 8" pneumatisch
2.0 TDI 4motion	103	08/05→05/09			09/05→; +PR 1ZG; für Linkslenker		03.7873-4402.4 300292	ATE Ø 11" pneumatisch
					09/05→; +PR 1LJ; für Linkslenker		03.7873-4502.4 300284	ATE Ø 11" pneumatisch
3.6 R36 4motion	220	04/07→11/10			für Linkslenker		03.7873-4502.4 300284	ATE Ø 11" pneumatisch
 Hauptbremszylinder								
1.4 TSI	90	05/07→11/10			10/07→; +PR 1ZG; für Linkslenker		03.4152-0116.3 010814	ATE Ø 22,2
1.8 TSI	118	05/07→10/11			10/07→; +PR 1LJ / 1LK / 1LH / 1LM; für Linkslenker		03.4153-0186.3 010816	ATE Ø 23,8
					10/07→; +PR 1LJ / 1LK; für Rechtslenker		24.4153-0192.3 011026	ATE Ø 23,8 ohne Bremsflüssigkeitsbehälter
1.4 TSI EcoFuel	110	01/09→11/10			+PR 1ZG; für Linkslenker		03.4152-0116.3 010814	ATE Ø 22,2
1.6	75	08/05→11/10			+PR 1LJ / 1LK / 1LH / 1LM; für Linkslenker		03.4153-0186.3 010816	ATE Ø 23,8
1.6 FSI	85	08/05→06/08						
1.6 TDI	77	08/09→11/10						
1.8 TSI	112	11/09→11/10			+PR 1LJ / 1LK; für Rechtslenker		24.4153-0192.3 011026	ATE Ø 23,8 ohne Bremsflüssigkeitsbehälter
1.9 TDI	77	08/05→11/10						
2.0 BlueTDI	105	01/09→11/10						
2.0 FSI	110	08/05→11/10						
2.0 FSI 4motion	110	09/05→11/10						
2.0 TDI	81 - 125	08/05→11/10						
2.0 TDI 16V	103	08/05→11/10						
2.0 TDI 4motion	125	05/09→11/10						













	kw					! #		
VW - PASSAT B6 Variant (3C5) 08/05→11/11								
 Hauptbremszylinder								
2.0 TFSI 3.2 FSI 4motion 3.6 R36 4motion	147 184 220	08/05→11/10 11/05→11/10 04/07→11/10		+PR 1ZG; für Linkslenker		03.4152-0116.3	010814	ATE Ø 22,2
				+PR 1LJ / 1LK / 1LH / 1LM; für Linkslenker		03.4153-0186.3	010816	ATE Ø 23,8
				+PR 1LJ / 1LK; für Rechtslenker		24.4153-0192.3	011026	ATE Ø 23,8 ohne Bremsflüssigkeitsbehälter
2.0 TDI 16V 4motion 2.0 TDI 4motion	103 103	08/05→11/10 08/05→05/09		09/05→; +PR 1ZG; für Linkslenker		03.4152-0116.3	010814	ATE Ø 22,2
				09/05→; +PR 1LJ / 1LK / 1LH / 1LM; für Linkslenker		03.4153-0186.3	010816	ATE Ø 23,8
				09/05→; +PR 1LJ / 1LK; für Rechtslenker		24.4153-0192.3	011026	ATE Ø 23,8 ohne Bremsflüssigkeitsbehälter
VW - PASSAT B7 (362) 08/10→04/16								
 Bremskraftverstärker								
1.4 TSI 1.4 TSI EcoFuel 1.4 TSI MultiFuel 1.6 TDI 1.8 TSI 2.0 TDI 2.0 TDI 4motion 2.0 TSI 3.6 FSI 4motion 2.0 TDI 4motion	90 - 118 110 118 77 112 - 118 100 - 130 103 - 130 155 220 125	08/10→12/14 08/10→12/14 11/10→12/14 08/10→12/14 08/10→12/14 08/10→12/14 11/10→12/14 01/11→12/14 08/10→01/13		→ 10/14; +PR 1LA / 1LB / 1ZM; für Rechtslenker		03.7848-9802.4	300344	ATE Ø 7 / 8" pneumatisch
				→ 10/14; +PR 1ZG; für Linkslenker		03.7873-4402.4	300292	ATE Ø 11" pneumatisch
				→ 10/14; +PR 1LA / 1LB / 1ZM; für Linkslenker		03.7873-4502.4	300284	ATE Ø 11" pneumatisch
				+PR 1LA / 1LB / 1ZM; für Rechtslenker		03.7848-9802.4	300344	ATE Ø 7 / 8" pneumatisch
				+PR 1ZG; für Linkslenker		03.7873-4402.4	300292	ATE Ø 11" pneumatisch
				+PR 1LA / 1LB / 1ZM; für Linkslenker		03.7873-4502.4	300284	ATE Ø 11" pneumatisch
 Hauptbremszylinder								
1.4 TSI 1.4 TSI EcoFuel 1.4 TSI MultiFuel 1.6 TDI 1.8 TSI 2.0 TDI 2.0 TDI 4motion 2.0 TSI 3.6 FSI 4motion 2.0 TDI 4motion	90 - 118 110 118 77 112 - 118 100 - 130 103 - 130 155 220 125	08/10→12/14 08/10→12/14 11/10→12/14 08/10→12/14 08/10→12/14 08/10→12/14 11/10→12/14 01/11→12/14 08/10→01/13		→ 10/14; +PR 1ZG; für Linkslenker		03.4152-0116.3	010814	ATE Ø 22,2
				→ 10/14; +PR 1LA / 1LB / 1ZM; für Linkslenker		03.4153-0186.3	010816	ATE Ø 23,8
				→ 10/14; +PR 1LA / 1LB / 1ZM; für Rechtslenker		24.4153-0192.3	011026	ATE Ø 23,8 ohne Bremsflüssigkeitsbehälter
				+PR 1ZG; für Linkslenker		03.4152-0116.3	010814	ATE Ø 22,2
				+PR 1LA / 1LB / 1ZM; für Linkslenker		03.4153-0186.3	010816	ATE Ø 23,8
				+PR 1LA / 1LB / 1ZM; für Rechtslenker		24.4153-0192.3	011026	ATE Ø 23,8 ohne Bremsflüssigkeitsbehälter
VW - PASSAT B7 (A32, A33) 01/11→12/20								
 Bremskraftverstärker								
2.0 TDI 2.5	103 125	04/11→06/15 01/11→12/20		→ 10/14; +PR 1LA / 1LB / 1ZM; für Rechtslenker		03.7848-9802.4	300344	ATE Ø 7 / 8" pneumatisch
				→ 10/14; +PR 1ZG; für Linkslenker		03.7873-4402.4	300292	ATE Ø 11" pneumatisch
				→ 10/14; +PR 1LA / 1LB / 1ZM; für Linkslenker		03.7873-4502.4	300284	ATE Ø 11" pneumatisch
2.0 TDI	110	06/14→12/15		+PR 1LA / 1LB / 1ZM; für Rechtslenker		03.7848-9802.4	300344	ATE Ø 7 / 8" pneumatisch
				+PR 1ZG; für Linkslenker		03.7873-4402.4	300292	ATE Ø 11" pneumatisch
				+PR 1LA / 1LB / 1ZM; für Linkslenker		03.7873-4502.4	300284	ATE Ø 11" pneumatisch
 Hauptbremszylinder								
2.0 TDI 2.5	103 125	04/11→06/15 01/11→12/20		→ 10/14; +PR 1ZG; für Linkslenker		03.4152-0116.3	010814	ATE Ø 22,2
				→ 10/14; +PR 1LA / 1LB / 1ZM; für Linkslenker		03.4153-0186.3	010816	ATE Ø 23,8
				→ 10/14; +PR 1LA / 1LB / 1ZM; für Rechtslenker		24.4153-0192.3	011026	ATE Ø 23,8 ohne Bremsflüssigkeitsbehälter
2.0 TDI	110	06/14→12/15		+PR 1ZG; für Linkslenker		03.4152-0116.3	010814	ATE Ø 22,2
				+PR 1LA / 1LB / 1ZM; für Linkslenker		03.4153-0186.3	010816	ATE Ø 23,8
				+PR 1LA / 1LB / 1ZM; für Rechtslenker		24.4153-0192.3	011026	ATE Ø 23,8 ohne Bremsflüssigkeitsbehälter













	kw					! #		
VW - PASSAT B7 Kasten/Kombi (365) 08/10→12/14								
 Bremskraftverstärker								
1.4 TSi BlueMotion	90	08/10→12/14		→ 10/14; +PR 1LA / 1LB / 1ZM; für Rechtslenker		03.7848-9802.4	300344	ATE Ø 7 / 8" pneumatisch
1.6 TDI BlueMotion	77	08/10→12/14						
1.8 TSI	112 - 118	08/10→12/14		→ 10/14; +PR 1ZG; für Linkslenker		03.7873-4402.4	300292	ATE Ø 11" pneumatisch
2.0 TDI	100 - 130	08/10→12/14		→ 10/14; +PR 1LA / 1LB / 1ZM; für Linkslenker		03.7873-4502.4	300284	ATE Ø 11" pneumatisch
2.0 TDI BlueMotion	103	08/10→12/14						
2.0 TSI	155	11/10→12/14						
3.6 FSi 4motion	220	01/11→12/14						
2.0 TDI BlueMotion	125	08/10→12/14		→ 10/14; +PR 1LA / 1LB / 1ZM; für Rechtslenker		03.7848-9802.4	300344	ATE Ø 7 / 8" pneumatisch
				+PR 1ZG; für Linkslenker		03.7873-4402.4	300292	ATE Ø 11" pneumatisch
				+PR 1LA / 1LB / 1ZM; für Linkslenker		03.7873-4502.4	300284	ATE Ø 11" pneumatisch
 Hauptbremszylinder								
1.4 TSi BlueMotion	90	08/10→12/14		→ 10/14; +PR 1ZG; für Linkslenker		03.4152-0116.3	010814	ATE Ø 22,2
1.6 TDI BlueMotion	77	08/10→12/14						
1.8 TSI	112 - 118	08/10→12/14		→ 10/14; für Linkslenker; +PR 1LA / 1LB / 1ZM		03.4153-0186.3	010816	ATE Ø 23,8
2.0 TDI	100 - 130	08/10→12/14		→ 10/14; für Rechtslenker; +PR 1LA / 1LB / 1ZM		24.4153-0192.3	011026	ATE Ø 23,8 ohne Bremsflüssigkeitsbehälter
2.0 TDI BlueMotion	103	08/10→12/14						
2.0 TSI	155	11/10→12/14						
3.6 FSi 4motion	220	01/11→12/14						
2.0 TDI BlueMotion	125	08/10→12/14		+PR 1ZG; für Linkslenker		03.4152-0116.3	010814	ATE Ø 22,2
				+PR 1LA / 1LB / 1ZM; für Linkslenker		03.4153-0186.3	010816	ATE Ø 23,8
				+PR 1LA / 1LB / 1ZM; für Rechtslenker		24.4153-0192.3	011026	ATE Ø 23,8 ohne Bremsflüssigkeitsbehälter
VW - PASSAT B7 Variant (365) 08/10→12/15								
 Bremskraftverstärker								
1.4 TSI	90 - 118	08/10→12/14		→ 10/14; +PR 1LA / 1LB / 1ZM; für Rechtslenker		03.7848-9802.4	300344	ATE Ø 7 / 8" pneumatisch
1.4 TSI EcoFuel	110	08/10→12/14		→ 10/14; +PR 1ZG; für Linkslenker		03.7873-4402.4	300292	ATE Ø 11" pneumatisch
1.4 TSI MultiFuel	118	11/10→12/14						
1.6 TDI	77	08/10→12/14		→ 10/14; +PR 1LA / 1LB / 1ZM; für Linkslenker		03.7873-4502.4	300284	ATE Ø 11" pneumatisch
1.8 TSI	112 - 118	08/10→12/14						
2.0 TDI	100 - 130	08/10→12/14						
2.0 TDI 4motion	103 - 130	08/10→12/14						
2.0 TSI	155	11/10→12/15						
3.6 FSi 4motion	220	01/11→12/14						
2.0 TDI 4motion	125	08/10→01/13		+PR 1LA / 1LB / 1ZM; für Rechtslenker		03.7848-9802.4	300344	ATE Ø 7 / 8" pneumatisch
				+PR 1ZG; für Linkslenker		03.7873-4402.4	300292	ATE Ø 11" pneumatisch
				+PR 1LA / 1LB / 1ZM; für Linkslenker		03.7873-4502.4	300284	ATE Ø 11" pneumatisch
 Hauptbremszylinder								
1.4 TSI	90 - 118	08/10→12/14		→ 10/14; +PR 1ZG; für Linkslenker		03.4152-0116.3	010814	ATE Ø 22,2
1.4 TSI EcoFuel	110	08/10→12/14		→ 10/14; +PR 1LA / 1LB / 1ZM; für Linkslenker		03.4153-0186.3	010816	ATE Ø 23,8
1.4 TSI MultiFuel	118	11/10→12/14						
1.6 TDI	77	08/10→12/14		→ 10/14; +PR 1LA / 1LB / 1ZM; für Rechtslenker		24.4153-0192.3	011026	ATE Ø 23,8 ohne Bremsflüssigkeitsbehälter
1.8 TSI	112 - 118	08/10→12/14						
2.0 TDI	100 - 130	08/10→12/14						
2.0 TDI 4motion	103 - 130	08/10→12/14						
2.0 TSI	155	11/10→12/15						
3.6 FSi 4motion	220	01/11→12/14						
2.0 TDI 4motion	125	08/10→01/13		+PR 1ZG; für Linkslenker		03.4152-0116.3	010814	ATE Ø 22,2
				+PR 1LA / 1LB / 1ZM; für Linkslenker		03.4153-0186.3	010816	ATE Ø 23,8
				+PR 1LA / 1LB / 1ZM; für Rechtslenker		24.4153-0192.3	011026	ATE Ø 23,8 ohne Bremsflüssigkeitsbehälter
VW - PASSAT B8 (3G2, CB2) 08/14→								
 Hauptbremszylinder								
1.4 GTE Hybrid	160	06/15→11/18		für Linkslenker; +PR 1ZA / 1ZD		24.4123-1719.3	011017	TRW Ø 23,8 ohne Bremsflüssigkeitsbehälter
1.4 TSI	92 - 110	11/14→						
1.4 TSI 4motion	110	02/15→				24.4153-1522.3	011048	ATE Ø 23,8 ohne Bremsflüssigkeitsbehälter
1.5 TSI	110	08/18→						
1.8 TSI	132	02/15→						
→								







	kw					! #		
VW - PASSAT B8 (3G2, CB2) 08/14→								
 Hauptbremszylinder								
2.0 TDI	81 - 147	11/14→			für Linkslenker; +PR 1ZA / 1ZD		24.4123-1719.3 011017	TRW Ø 23,8 ohne Bremsflüssigkeitsbehälter
2.0 TDI 4motion	140 - 147	11/14→					24.4153-1522.3 011048	ATE Ø 23,8 ohne Bremsflüssigkeitsbehälter
2.0 TSI	140 - 162	02/15→						
2.0 TSI 4motion	200 - 206	05/15→						
1.6 TDI	88	08/14→			für Linkslenker; +PR 1ZA / 1ZD		24.4123-1719.3 011017	TRW Ø 23,8 ohne Bremsflüssigkeitsbehälter
2.0 TDI 4motion	110 - 176	08/14→						
					11/14→; für Linkslenker; +PR 1ZA / 1ZD		24.4153-1522.3 011048	ATE Ø 23,8 ohne Bremsflüssigkeitsbehälter
VW - PASSAT B8 Variant (3G5, CB5) 08/14→								
 Hauptbremszylinder								
1.4 GTE Hybrid	160	06/15→			für Linkslenker; +PR 1ZA / 1ZD		24.4123-1719.3 011017	TRW Ø 23,8 ohne Bremsflüssigkeitsbehälter
1.4 TSI	92 - 110	11/14→					24.4153-1522.3 011048	ATE Ø 23,8 ohne Bremsflüssigkeitsbehälter
1.4 TSI 4motion	110	02/15→						
1.5 TSI	110	08/18→						
1.8 TSI	132	02/15→						
2.0 TDI	81 - 147	11/14→						
2.0 TDI 4motion	140 - 147	11/14→						
2.0 TSI	140	11/18→						
2.0 TSI 4motion	200 - 206	05/15→						
1.6 TDI	88	08/14→			für Linkslenker; +PR 1ZA / 1ZD		24.4123-1719.3 011017	TRW Ø 23,8 ohne Bremsflüssigkeitsbehälter
2.0 TDI 4motion	110 - 176	08/14→						
2.0 TSI	162	08/14→			11/14→; für Linkslenker; +PR 1ZA / 1ZD		24.4153-1522.3 011048	ATE Ø 23,8 ohne Bremsflüssigkeitsbehälter
VW - PASSAT CC B6 (357) 02/08→06/12								
 Bremskraftverstärker								
1.4 TSI MultiFuel	118	01/11→01/12			→ 09/11; für Rechtslenker; +PR 1LH / 1ZM		03.7848-9802.4 300344	ATE Ø 7 / 8" pneumatisch
2.0 TSI	155	11/10→01/12			für Linkslenker; → 09/11; +PR 1ZG		03.7873-4402.4 300292	ATE Ø 11" pneumatisch
					→ 09/11; für Linkslenker; +PR 1LA / 1LB / 1ZM		03.7873-4502.4 300284	ATE Ø 11" pneumatisch
1.8 TSI	112	11/08→05/10			+PR 1LH / 1ZM; für Rechtslenker		03.7848-9802.4 300344	ATE Ø 7 / 8" pneumatisch
2.0 TDI	120	02/08→05/09			für Linkslenker; +PR 1AT / 1ZG		03.7873-4402.4 300292	ATE Ø 11" pneumatisch
					für Linkslenker; +PR 1AT / 1LH / 1LK / 1ZM		03.7873-4502.4 300284	ATE Ø 11" pneumatisch
1.8 TSI	118	06/08→01/12			→ 09/11; für Rechtslenker; +PR 1LH / 1ZM		03.7848-9802.4 300344	ATE Ø 7 / 8" pneumatisch
2.0 TDI	103 - 125	06/08→01/12						
2.0 TDI 4motion	103 - 125	08/09→01/12			→ 05/10; für Linkslenker; +PR 1AT / 1ZG		03.7873-4402.4 300292	ATE Ø 11" pneumatisch
2.0 TFSI	147	06/08→01/12			06/10→ 09/11; für Linkslenker; +PR 1ZG		03.7873-4402.4 300292	ATE Ø 11" pneumatisch
					→ 10/10; +PR 1AT / 1LH / 1LK / 1ZM; für Linkslenker		03.7873-4502.4 300284	ATE Ø 11" pneumatisch
					11/10→ 09/11; +PR 1LA / 1LB / 1ZM; für Linkslenker		03.7873-4502.4 300284	ATE Ø 11" pneumatisch
2.0 BlueTDI	105	05/09→11/10			+PR 1LH / 1ZM; für Rechtslenker		03.7848-9802.4 300344	ATE Ø 7 / 8" pneumatisch
2.0 TDI	100	06/08→05/11			06/10→; +PR 1ZG; für Linkslenker		03.7873-4402.4 300292	ATE Ø 11" pneumatisch
					→ 05/10; für Linkslenker; +PR 1AT / 1ZG		03.7873-4402.4 300292	ATE Ø 11" pneumatisch
					11/10→; +PR 1LA / 1LB / 1ZM; für Linkslenker		03.7873-4502.4 300284	ATE Ø 11" pneumatisch
					→ 10/10; +PR 1AT / 1LH / 1LK / 1ZM; für Linkslenker		03.7873-4502.4 300284	ATE Ø 11" pneumatisch
3.6 FSI 4motion	206	06/08→01/12			→ 09/11; für Rechtslenker; +PR 1LH / 1ZM		03.7848-9802.4 300344	ATE Ø 7 / 8" pneumatisch
					→ 10/10; +PR 1AT / 1LH / 1LK / 1ZM; für Linkslenker		03.7873-4502.4 300284	ATE Ø 11" pneumatisch
					11/10→ 09/11; +PR 1LA / 1LB / 1ZM; für Linkslenker		03.7873-4502.4 300284	ATE Ø 11" pneumatisch
3.6 FSI 4motion	220	02/08→12/11			04/08→ 09/11; für Rechtslenker; +PR 1LH / 1ZM		03.7848-9802.4 300344	ATE Ø 7 / 8" pneumatisch
					für Linkslenker; +PR 1AT / 1LH / 1LK / 1ZM		03.7873-4502.4 300284	ATE Ø 11" pneumatisch
 Hauptbremszylinder								
1.4 TSI MultiFuel	118	01/11→01/12			→ 09/11; für Linkslenker; +PR 1ZG		03.4152-0116.3 010814	ATE Ø 22,2
→								

	kw					! #		
VW - PASSAT CC B6 (357) 02/08→06/12								
 Hauptbremszylinder								
2.0 TDI 4motion	103 - 125	08/09→01/12		→ 09/11; für Linkslenker; +PR 1LH / 1LK / 1ZM		03.4153-0186.3	010816	ATE Ø 23,8
				→ 09/11; für Rechtslenker; +PR 1LH / 1LK / 1ZM		24.4153-0192.3	011026	ATE Ø 23,8 ohne Bremsflüssigkeitsbehälter
1.8 TSI	112	11/08→05/10		+PR 1ZG; für Linkslenker		03.4152-0116.3	010814	ATE Ø 22,2
2.0 BlueTDI	105	05/09→11/10		für Linkslenker; +PR 1LH / 1LK		03.4153-0186.3	010816	ATE Ø 23,8
2.0 TDI	100 - 120	02/08→05/11		für Rechtslenker; +PR 1LH / 1LK		24.4153-0192.3	011026	ATE Ø 23,8 ohne Bremsflüssigkeitsbehälter
3.6 FSI 4motion	220	02/08→12/11						
1.8 TSI	118	06/08→01/12		→ 09/11; für Linkslenker; +PR 1ZG		03.4152-0116.3	010814	ATE Ø 22,2
2.0 TDI	103 - 125	06/08→01/12		→ 09/11; +PR 1LH / 1LK; für Linkslenker		03.4153-0186.3	010816	ATE Ø 23,8
2.0 TFSI	147	06/08→01/12		→ 09/11; +PR 1LH / 1LK; für Rechtslenker		24.4153-0192.3	011026	ATE Ø 23,8 ohne Bremsflüssigkeitsbehälter
2.0 TSI	155	11/10→01/12						
3.6 FSI 4motion	206	06/08→01/12						
VW - POLO (6N2) 10/99→10/01								
 Bremskraftverstärker								
1.4	40 - 44	10/99→09/01		→ 6N-T-300000; für Linkslenker; + ABS		03.7750-6002.4	300134	ATE Ø 9" pneumatisch
1.4 16V	74	10/99→09/01						
1.9 D	47	10/99→09/01						
1.9 SDI	47	10/99→09/01						
 Hauptbremszylinder								
1.0	37	10/99→09/01		für Linkslenker; - ABS		03.2120-3943.3	010532	ATE Ø 20,6
1.7 SDI	44	10/99→09/01		+ ABS		03.2122-1344.3	010593	ATE Ø 22,2
1.4	40	10/99→09/01		für Linkslenker; - ABS		03.2120-3943.3	010532	ATE Ø 20,6
1.4 16V	55	10/99→09/01						
1.4	44	10/99→09/01		für Linkslenker; - ABS		03.2120-3943.3	010532	ATE Ø 20,6
1.9 D	47	10/99→09/01		6N-V-000001→; + ABS		03.2122-1344.3	010593	ATE Ø 22,2
1.9 SDI	47	10/99→09/01						
1.4 16V	74	10/99→09/01		→ 6N-T-300000; + ABS		03.2123-1484.3	010595	ATE Ø 23,8
				6N-V-000001→; + ABS		03.2123-1824.3	010596	ATE Ø 23,8
1.4 TDI	55	10/99→09/01		+ ABS		03.2123-1824.3	010596	ATE Ø 23,8
1.6 16V GTI	92	10/99→09/01						
Verschlusschraube, Hauptbremszylinder								
1.0	37	10/99→09/01		für Linkslenker; - ABS		03.3517-0101.2	390322	
1.4	40 - 44	10/99→09/01						
1.4 16V	55	10/99→09/01						
1.7 SDI	44	10/99→09/01						
1.9 D	47	10/99→09/01						
1.9 SDI	47	10/99→09/01						
VW - POLO III CLASSIC (6V2) 01/95→11/09								
 Bremskraftverstärker								
1.6	74	11/02→07/06		für Linkslenker; - ABS		03.7750-6302.4	300161	ATE Ø 9" pneumatisch
2.0	85	08/99→09/01		für Linkslenker; + ABS; +PR 1KB		10.6350-3902.4	300213	ATE Ø 9" pneumatisch
90 1.9 TDI	66	09/96→09/01		für Linkslenker; + ABS; +PR 1KK / 1KM / 1KQ		10.6350-4002.4	300285	ATE Ø 9" pneumatisch
1.9 SDI	48	06/96→09/01		für Linkslenker; + ABS; +PR 1KB		10.6350-3902.4	300213	ATE Ø 9" pneumatisch
57 1.7 SDI	42	07/97→09/01		für Linkslenker; + ABS; +PR 1KK / 1KM / 1KQ		10.6350-4002.4	300285	ATE Ø 9" pneumatisch
60 1.4	44	12/95→09/01						
75 1.4 16V	55	10/99→09/01						
75 1.6	55	11/95→09/01						
100 1.6	74	12/95→09/01		für Linkslenker; - ABS		03.7750-6302.4	300161	ATE Ø 9" pneumatisch
				05/96→; für Linkslenker; + ABS; +PR 1KB		10.6350-3902.4	300213	ATE Ø 9" pneumatisch
				05/96→; für Linkslenker; + ABS; +PR 1KK / 1KM / 1KQ		10.6350-4002.4	300285	ATE Ø 9" pneumatisch
110 1.9 TDI	81	06/98→01/02		für Linkslenker; - ABS; → 09/01		03.7750-6302.4	300161	ATE Ø 9" pneumatisch
				für Linkslenker; + ABS; → 09/01; +PR 1KB		10.6350-3902.4	300213	ATE Ø 9" pneumatisch
				für Linkslenker; + ABS; → 09/01; +PR 1KK / 1KM / 1KQ		10.6350-4002.4	300285	ATE Ø 9" pneumatisch
68 1.9 SDI	50	08/99→01/02		für Linkslenker; + ABS; → 09/01; +PR 1KB		10.6350-3902.4	300213	ATE Ø 9" pneumatisch
				für Linkslenker; + ABS; → 09/01; +PR 1KK / 1KM / 1KQ		10.6350-4002.4	300285	ATE Ø 9" pneumatisch
90 1.8	66	01/97→09/01		03/98→; für Linkslenker; - ABS		03.7750-6302.4	300161	ATE Ø 9" pneumatisch
				03/98→; für Linkslenker; + ABS; +PR 1KB		10.6350-3902.4	300213	ATE Ø 9" pneumatisch
→								









	kw					! #		
VW - POLO III CLASSIC (6V2) 01/95→11/09								
 Bremskraftverstärker								
90 1.8	66	01/97→09/01		03/98→; für Linkslenker; + ABS; +PR 1KK / 1KM / 1KQ		10.6350-4002.4	300285	ATE Ø 9" pneumatisch
 Hauptbremszylinder								
1.6	74	11/02→07/06		für Linkslenker; - ABS		03.2122-1042.3	010137	Ø 22,2
90 1.9 TDI	66	09/96→09/01		→ 6K-X-523000; für Rechtslenker; - ABS		03.2122-1042.3	010137	Ø 22,2
				für Linkslenker; + ABS		03.2122-1144.3	010636	ATE Ø 22,2
1.9 SDI 60 1.4 75 1.4 16V	48 44	06/96→09/01 12/95→09/01		für Linkslenker; - ABS		03.2120-3943.3	010532	ATE Ø 20,6
			55	10/99→09/01	→ 6K-X-523000; für Rechtslenker; - ABS		03.2120-3943.3	010532
100 1.6	74	12/95→09/01		für Linkslenker; - ABS		03.2122-1042.3	010137	Ø 22,2
				→ 6K-X-523000; für Rechtslenker; - ABS		03.2122-1042.3	010137	Ø 22,2
				05/96→; für Linkslenker; + ABS		03.2122-1144.3	010636	ATE Ø 22,2
110 1.9 TDI	81	06/98→01/02		für Linkslenker; - ABS; → 09/01		03.2122-1042.3	010137	Ø 22,2
				→ 6K-X-523000; für Rechtslenker; - ABS		03.2122-1042.3	010137	Ø 22,2
				für Linkslenker; + ABS; → 09/01		03.2122-1144.3	010636	ATE Ø 22,2
2.0	85	08/99→09/01		für Linkslenker; + ABS		03.2122-1144.3	010636	ATE Ø 22,2
57 1.7 SDI	42	07/97→09/01		für Linkslenker; - ABS		03.2120-3943.3	010532	ATE Ø 20,6
				11/97→; → 6K-X-523000; für Rechtslenker; - ABS		03.2120-3943.3	010532	ATE Ø 20,6
				für Linkslenker; + ABS		03.2122-1144.3	010636	ATE Ø 22,2
68 1.9 SDI	50	08/99→01/02		für Linkslenker; - ABS; → 09/01		03.2120-3943.3	010532	ATE Ø 20,6
				→ 6K-X-523000; für Rechtslenker; - ABS		03.2120-3943.3	010532	ATE Ø 20,6
				für Linkslenker; + ABS; → 09/01		03.2122-1144.3	010636	ATE Ø 22,2
75 1.6	55	11/95→09/01		6K-V-022629→ 6K-X-523000; für Rechtslenker; - ABS		03.2120-3943.3	010532	ATE Ø 20,6
				6K-V-022629→; für Linkslenker; - ABS		03.2120-3943.3	010532	ATE Ø 20,6
				→ 6K-V-022628; - ABS		03.2122-1042.3	010137	Ø 22,2
				für Linkslenker; + ABS		03.2122-1144.3	010636	ATE Ø 22,2
90 1.8	66	01/97→09/01		03/98→; für Linkslenker; + ABS		03.2122-1144.3	010636	ATE Ø 22,2
VW - POLO IV (9N_, 9A_) 10/01→10/14								
 Hauptbremszylinder								
1.2	40	01/02→05/07		9N-5-500001→; - ABS		24.2119-1716.3	011120	FTE Ø 19 ohne Bremsflüssigkeitsbehälter
				- ABS; für Fahrzeuge ohne Servolenkung; → 9N-5-180000		24.2120-1736.3	010732	Ø 20,6
				9N-5-500001→; + ABS		24.2120-1734.3	010702	Ø 20,6
				- ABS; für Fahrzeuge mit Servolenkung; → 9N-5-180000		24.2120-1736.3	010732	Ø 20,6
1.2 12V 1.2 12V 1.8 GTI	44 51 110	05/07→11/09 05/07→11/09 09/05→11/09		→ 05/09; - ABS		24.2119-1716.3	011120	FTE Ø 19 ohne Bremsflüssigkeitsbehälter
				→ 05/09; + ABS		24.2120-1734.3	010702	Ø 20,6
1.2 12V	47	10/01→07/07		11/01→; - ABS		24.2119-1716.3	011120	FTE Ø 19 ohne Bremsflüssigkeitsbehälter
						24.2120-1736.3	010732	Ø 20,6
				11/01→; + ABS		24.2120-1734.3	010702	Ø 20,6
1.4	61	08/02→11/09		9N-5-500001→; → 05/09; - ABS		24.2119-1716.3	011120	FTE Ø 19 ohne Bremsflüssigkeitsbehälter
				9N-5-500001→; → 05/09; + ABS		24.2120-1734.3	010702	Ø 20,6
				05/06→; → 9N-5-180000; + ABS		24.2120-1734.3	010702	Ø 20,6
				05/06→; → 9N-5-180000; - ABS		24.2120-1736.3	010732	Ø 20,6
1.4 16V 1.4 TDI	55 - 74 55	10/01→05/08 10/01→06/05		9N-5-500001→; - ABS		24.2119-1716.3	011120	FTE Ø 19 ohne Bremsflüssigkeitsbehälter
				11/01→; + ABS; → 9N-5-180000		24.2120-1734.3	010702	Ø 20,6
				9N-5-500001→; + ABS		24.2120-1734.3	010702	Ø 20,6
				11/01→; - ABS; → 9N-5-180000		24.2120-1736.3	010732	Ø 20,6
1.4 16V 1.4 BiFuel 1.4 TDI	59 60 51 - 59	05/06→11/09 05/06→11/09 04/05→11/09		9N-5-500001→; → 05/09; - ABS		24.2119-1716.3	011120	FTE Ø 19 ohne Bremsflüssigkeitsbehälter
						24.2120-1736.3	010732	Ø 20,6







	kw					! #		
VW - POLO IV (9N_, 9A_) 10/01→10/14								
 Hauptbremszylinder								
1.6 16V 1.9 TDI	77 96	05/06→11/09 11/03→11/09		9N-5-500001→; → 05/09; + ABS	24.2120-1734.3	010702	Ø 20,6	
				+ ABS; → 9N-5-180000	24.2120-1734.3	010702	Ø 20,6	
				- ABS; → 9N-5-180000	24.2120-1736.3	010732	Ø 20,6	
1.4 FSI 1.6 1.6 Flex	63 74 74	02/02→07/06 08/02→05/05 06/08→04/09		9N-5-500001→; - ABS	24.2119-1716.3	011120	FTE Ø 19 ohne Bremsflüssigkeitsbehälter	
				+ ABS; → 9N-5-180000	24.2120-1734.3	010702	Ø 20,6	
				9N-5-500001→; + ABS	24.2120-1734.3	010702	Ø 20,6	
				- ABS; → 9N-5-180000	24.2120-1736.3	010732	Ø 20,6	
1.8 GTI Cup Edition	132	05/06→11/09		06/06→ 05/09; - ABS	24.2119-1716.3	011120	FTE Ø 19 ohne Bremsflüssigkeitsbehälter	
				06/06→ 05/09; + ABS	24.2120-1734.3	010702	Ø 20,6	
1.9 SDI 1.9 TDI	47 74	10/01→11/09 10/01→11/09		9N-5-500001→; → 05/09; - ABS	24.2119-1716.3	011120	FTE Ø 19 ohne Bremsflüssigkeitsbehälter	
				9N-5-500001→; → 05/09; + ABS	24.2120-1734.3	010702	Ø 20,6	
				11/01→; + ABS; → 9N-5-180000	24.2120-1734.3	010702	Ø 20,6	
				11/01→; - ABS; → 9N-5-180000	24.2120-1736.3	010732	Ø 20,6	
 Bremskraftregler								
1.2	40	01/02→05/07		- ABS	03.6583-0216.3	320247	ATE lastabhängig 8/3 4x	
VW - POLO IV Stufenheck (9A4, 9A2, 9N2, 9A6) 09/02→								
 Hauptbremszylinder								
1.0 1.4 1.4 TDI	58 74 55	02/03→10/03 11/03→06/05 07/03→06/05		9N-5-500001→; - ABS	24.2119-1716.3	011120	FTE Ø 19 ohne Bremsflüssigkeitsbehälter	
				+ ABS; → 9N-5-180000	24.2120-1734.3	010702	Ø 20,6	
				9N-5-500001→; + ABS	24.2120-1734.3	010702	Ø 20,6	
				- ABS; → 9N-5-180000	24.2120-1736.3	010732	Ø 20,6	
1.4 1.6 Flex 1.9 SDI 1.9 TDi 2.0 Flex	55 - 61 77 47 74 88	11/02→04/12 05/08→10/14 09/02→04/12 09/02→ 10/08→12/14		9N-5-500001→; → 05/09; - ABS	24.2119-1716.3	011120	FTE Ø 19 ohne Bremsflüssigkeitsbehälter	
				9N-5-500001→; → 05/09; + ABS	24.2120-1734.3	010702	Ø 20,6	
				+ ABS; → 9N-5-180000	24.2120-1734.3	010702	Ø 20,6	
				- ABS; → 9N-5-180000	24.2120-1736.3	010732	Ø 20,6	
1.6	74	09/02→		9N-5-500001→; → 05/09; - ABS	24.2119-1716.3	011120	FTE Ø 19 ohne Bremsflüssigkeitsbehälter	
				9N-5-500001→; → 05/09; + ABS	24.2120-1734.3	010702	Ø 20,6	
				05/06→; → 9N-5-180000; + ABS	24.2120-1734.3	010702	Ø 20,6	
				05/06→; → 9N-5-180000; - ABS	24.2120-1736.3	010732	Ø 20,6	
1.6 Flex 1.6 Total Flex	76 74	12/04→10/14 10/04→06/06		9N-5-500001→; - ABS	24.2119-1716.3	011120	FTE Ø 19 ohne Bremsflüssigkeitsbehälter	
				05/06→; → 9N-5-180000; + ABS	24.2120-1734.3	010702	Ø 20,6	
				9N-5-500001→; + ABS	24.2120-1734.3	010702	Ø 20,6	
				05/06→; → 9N-5-180000; - ABS	24.2120-1736.3	010732	Ø 20,6	
VW - POLO IV Stufenheck (9N2, 9N4) 09/02→12/10								
 Hauptbremszylinder								
1.9 TDI	74	07/03→12/10		9N-5-500001→; → 05/09; - ABS	24.2119-1716.3	011120	FTE Ø 19 ohne Bremsflüssigkeitsbehälter	
				9N-5-500001→; → 05/09; + ABS	24.2120-1734.3	010702	Ø 20,6	
				+ ABS; → 9N-5-180000	24.2120-1734.3	010702	Ø 20,6	
				- ABS; → 9N-5-180000	24.2120-1736.3	010732	Ø 20,6	
VW - POLO VI (AW1, BZ1, AE1) 06/17→								
 Hauptbremszylinder								
1.0 1.0 TSI →	48 - 55 70	06/17→08/21 06/17→		09/17→; für Linkslenker; +PR 1ZB / 1ZE / 1ZP	24.2123-1782.3	011146	TRW Ø 23,8 ohne Bremsflüssigkeitsbehälter	

	kw					! #		
VW - POLO VI (AW1, BZ1, AE1) 06/17→								
 Hauptbremszylinder								
1.0 MPI	59	09/18→			für Linkslenker; +PR 1ZB / 1ZE / 1ZP	24.2123-1782.3	011146	TRW Ø 23,8 ohne Bremsflüssigkeitsbehälter
1.0 TGI	66	09/17→						
1.0 TSI	81 - 85	09/17→						
1.5 TSI	110	10/18→08/21						
1.6 MSi	81	09/17→						
1.6 TDI	59 - 70	11/17→02/21						
2.0 GTI	147	11/17→						
GTI	152	04/21→						
VW - POLO Van Kasten/Kombi (6V5) 12/95→09/01								
 Bremskraftverstärker								
1.4	55	06/00→09/01			für Linkslenker; +PR 1KB; + ABS	10.6350-3902.4	300213	ATE Ø 9" pneumatisch
 Hauptbremszylinder								
1.4	55	06/00→09/01			- ABS	03.2122-1042.3	010137	Ø 22,2
					für Linkslenker; + ABS	03.2122-1144.3	010636	ATE Ø 22,2
1.9 SDI	50	10/99→09/01			9N-5-500001→; - ABS	24.2119-1716.3	011120	FTE Ø 19 ohne Bremsflüssigkeitsbehälter
					+ ABS; → 9N-5-180000	24.2120-1736.3	010732	Ø 20,6
					9N-5-500001→; + ABS	24.2120-1734.3	010702	Ø 20,6
					- ABS; → 9N-5-180000	24.2120-1736.3	010732	Ø 20,6
VW - POLO Variant (6V5) 04/97→09/01								
 Bremskraftverstärker								
1.4	44	05/97→09/01			für Linkslenker; +PR 1KB; + ABS	10.6350-3902.4	300213	ATE Ø 9" pneumatisch
1.4 16V	55	10/99→09/01						
1.6	55 - 74	05/97→09/01			für Linkslenker; - ABS	03.7750-6302.4	300161	ATE Ø 9" pneumatisch
					für Linkslenker; + ABS	10.6350-3902.4	300213	ATE Ø 9" pneumatisch
1.7 SDI	42	08/97→09/01			für Linkslenker; - ABS	03.7750-6302.4	300161	ATE Ø 9" pneumatisch
1.8	66	05/97→09/01						
1.9 SDI	47 - 50	06/97→09/01			für Linkslenker; +PR 1KB; + ABS	10.6350-3902.4	300213	ATE Ø 9" pneumatisch
1.9 TDI	66 - 81	05/97→09/01						
 Hauptbremszylinder								
1.4	44	05/97→09/01			- ABS	03.2122-1042.3	010137	Ø 22,2
1.4 16V	55	10/99→09/01						
1.6	55 - 74	05/97→09/01			für Linkslenker; + ABS	03.2122-1144.3	010636	ATE Ø 22,2
1.7 SDI	42	08/97→09/01						
1.8	66	05/97→09/01						
1.9 SDI	47 - 50	06/97→09/01						
1.9 TDI	66 - 81	05/97→09/01						
VW - SCIROCCO III (137, 138) 05/08→01/18								
 Bremskraftverstärker								
1.4 TSI	90	08/08→11/17			09/08→; für Rechtslenker; +PR 1ZA / 1ZB / 1ZE / 1LJ	03.7848-9802.4	300344	ATE Ø 7 / 8" pneumatisch
					09/08→; für Linkslenker; +PR 1ZK	03.7860-8802.4	300291	ATE Ø 10" pneumatisch
					09/08→; für Linkslenker; +PR 1ZD / 1ZP	03.7863-3232.4	300307	ATE Ø 10" pneumatisch
					09/08→; für Linkslenker; +PR 1ZA / 1ZE / 1LJ	03.7863-3332.4	300308	ATE Ø 10" pneumatisch
1.4 TSI	92 - 110	11/13→11/17			für Rechtslenker; +PR 1ZA / 1ZB / 1ZE / 1LJ	03.7848-9802.4	300344	ATE Ø 7 / 8" pneumatisch
2.0 R	188 - 195	11/09→11/17			+PR 1ZK; für Linkslenker	03.7860-8802.4	300291	ATE Ø 10" pneumatisch
2.0 TDI	100 - 135	05/09→11/17			für Linkslenker; +PR 1ZD / 1ZP	03.7863-3232.4	300307	ATE Ø 10" pneumatisch
2.0 TSI	132 - 162	11/09→11/17			für Linkslenker; +PR 1ZA / 1ZE / 1LJ	03.7863-3332.4	300308	ATE Ø 10" pneumatisch
1.4 TSI	118	05/08→11/17			08/08→; +PR 1ZA / 1ZB / 1ZE / 1LJ; für Rechtslenker	03.7848-9802.4	300344	ATE Ø 7 / 8" pneumatisch
2.0 TFSI	147	05/08→11/09			08/08→; +PR 1ZK; für Linkslenker	03.7860-8802.4	300291	ATE Ø 10" pneumatisch
					08/08→; +PR 1ZD / 1ZP; für Linkslenker	03.7863-3232.4	300307	ATE Ø 10" pneumatisch
					08/08→; +PR 1ZA / 1ZE / 1LJ; für Linkslenker	03.7863-3332.4	300308	ATE Ø 10" pneumatisch
→								

	kw			 	! #		
VW - SCIROCCO III (137, 138) 05/08→01/18							
Bremskraftverstärker							
2.0 R	206	05/14→11/17		08/14→; für Rechtslenker; +PR 1ZA / 1ZB / 1ZE / 1LJ	03.7848-9802.4	300344	ATE Ø 7 / 8" pneumatisch
				08/14→; für Linkslenker; +PR 1ZK	03.7860-8802.4	300291	ATE Ø 10" pneumatisch
				08/14→; für Linkslenker; +PR 1ZD / 1ZP	03.7863-3232.4	300307	ATE Ø 10" pneumatisch
				08/14→; für Linkslenker; +PR 1ZA / 1ZE / 1LJ	03.7863-3332.4	300308	ATE Ø 10" pneumatisch
2.0 TDI	103	08/08→11/17		10/08→; +PR 1ZA / 1ZB / 1ZE / 1LJ; für Rechtslenker	03.7848-9802.4	300344	ATE Ø 7 / 8" pneumatisch
				10/08→; +PR 1ZK; für Linkslenker	03.7860-8802.4	300291	ATE Ø 10" pneumatisch
				10/08→; +PR 1ZD / 1ZP; für Linkslenker	03.7863-3232.4	300307	ATE Ø 10" pneumatisch
				10/08→; +PR 1ZA / 1ZE / 1LJ; für Linkslenker	03.7863-3332.4	300308	ATE Ø 10" pneumatisch
Hauptbremszylinder							
1.4 TSI	90	08/08→11/17		09/08→; +PR 1ZD / 1ZP; für Linkslenker	03.2122-2129.3	010799	ATE Ø 22,2
				09/08→; +PR 1ZA / 1ZE / 1LJ / 1ZK; für Linkslenker	03.2123-3449.3	010808	ATE Ø 23,8
				09/08→; +PR 1ZD / 1ZP; für Rechtslenker	24.4152-0132.3	011025	ATE Ø 22,2 ohne Bremsflüssigkeitsbehälter
				09/08→; +PR 1ZA / 1ZE / 1LJ / 1ZK; für Rechtslenker	24.4153-0202.3	011027	ATE Ø 23,8 ohne Bremsflüssigkeitsbehälter
1.4 TSI	92 - 110	11/13→11/17		für Linkslenker; +PR 1ZD / 1ZP	03.2122-2129.3	010799	ATE Ø 22,2
			2.0 R	188 - 195	11/09→11/17		für Linkslenker; +PR 1ZA / 1ZE / 1LJ / 1ZK
2.0 TDI	100 - 135	05/09→11/17					für Rechtslenker; +PR 1ZD / 1ZP
			2.0 TSI	132 - 162	11/09→11/17		für Rechtslenker; +PR 1ZA / 1ZE / 1LJ / 1ZK
1.4 TSI 2.0 TFSI	118 147	05/08→11/17 05/08→11/09					08/08→; +PR 1ZD / 1ZP; für Linkslenker
				08/08→; +PR 1ZA / 1ZE / 1LJ / 1ZK; für Linkslenker	03.2123-3449.3	010808	ATE Ø 23,8
				08/08→; +PR 1ZD / 1ZP; für Rechtslenker	24.4152-0132.3	011025	ATE Ø 22,2 ohne Bremsflüssigkeitsbehälter
				08/08→; +PR 1ZA / 1ZE / 1LJ / 1ZK; für Rechtslenker	24.4153-0202.3	011027	ATE Ø 23,8 ohne Bremsflüssigkeitsbehälter
2.0 R	206	05/14→11/17		08/14→; für Linkslenker; +PR 1ZD / 1ZP	03.2122-2129.3	010799	ATE Ø 22,2
				08/14→; für Linkslenker; +PR 1ZA / 1ZE / 1LJ / 1ZK	03.2123-3449.3	010808	ATE Ø 23,8
				08/14→; für Rechtslenker; +PR 1ZD / 1ZP	24.4152-0132.3	011025	ATE Ø 22,2 ohne Bremsflüssigkeitsbehälter
				08/14→; für Rechtslenker; +PR 1ZA / 1ZE / 1LJ / 1ZK	24.4153-0202.3	011027	ATE Ø 23,8 ohne Bremsflüssigkeitsbehälter
2.0 TDI	103	08/08→11/17		10/08→; +PR 1ZD / 1ZP; für Linkslenker	03.2122-2129.3	010799	ATE Ø 22,2
				10/08→; +PR 1ZA / 1ZE / 1LJ / 1ZK; für Linkslenker	03.2123-3449.3	010808	ATE Ø 23,8
				10/08→; +PR 1ZD / 1ZP; für Rechtslenker	24.4152-0132.3	011025	ATE Ø 22,2 ohne Bremsflüssigkeitsbehälter
				10/08→; +PR 1ZA / 1ZE / 1LJ / 1ZK; für Rechtslenker	24.4153-0202.3	011027	ATE Ø 23,8 ohne Bremsflüssigkeitsbehälter
Drucksensor, Bremskraftverstärker							
1.4 TSI	90	08/08→11/17		09/08→; +PR 1ZD / 1ZP	03.0655-0101.2	370008	ATE
				09/08→; +PR 1ZK	03.0655-0101.2	370008	ATE
				09/08→; für Rechtslenker; +PR 1ZA / 1ZB / 1ZE / 1LJ	03.0655-0101.2	370008	ATE
				09/08→; für Linkslenker; +PR 1ZA / 1ZE / 1LJ	03.0655-0101.2	370008	ATE
1.4 TSI	92 - 110	11/13→11/17		+PR 1ZD / 1ZP	03.0655-0101.2	370008	ATE
			2.0 R	188 - 195	11/09→11/17		+PR 1ZK
2.0 TDI	100 - 135	05/09→11/17					für Linkslenker; +PR 1ZA / 1ZE / 1LJ
			2.0 TSI	132 - 162	11/09→11/17		für Rechtslenker; +PR 1ZA / 1ZB / 1ZE / 1LJ
1.4 TSI 2.0 TFSI	118 147	05/08→11/17 05/08→11/09					08/08→; +PR 1ZD / 1ZP
				08/08→; +PR 1ZK	03.0655-0101.2	370008	ATE
				08/08→; +PR 1ZA / 1ZE / 1LJ; für Linkslenker	03.0655-0101.2	370008	ATE
				08/08→; +PR 1ZA / 1ZB / 1ZE / 1LJ; für Rechtslenker	03.0655-0101.2	370008	ATE
→							



	kw			 	! #		
VW - SCIROCCO III (137, 138) 05/08→01/18							
Drucksensor, Bremskraftverstärker							
2.0 R	206	05/14→11/17		08/14→; +PR 1ZD / 1ZP	03.0655-0101.2	370008	ATE
				08/14→; +PR 1ZK	03.0655-0101.2	370008	ATE
				08/14→; für Rechtslenker; +PR 1ZA / 1ZB / 1ZE / 1LJ	03.0655-0101.2	370008	ATE
				08/14→; für Linkslenker; +PR 1ZA / 1ZE / 1LJ	03.0655-0101.2	370008	ATE
2.0 TDI	103	08/08→11/17		10/08→; +PR 1ZD / 1ZP	03.0655-0101.2	370008	ATE
				10/08→; +PR 1ZK	03.0655-0101.2	370008	ATE
				10/08→; +PR 1ZA / 1ZE / 1LJ; für Linkslenker	03.0655-0101.2	370008	ATE
				10/08→; +PR 1ZA / 1ZB / 1ZE / 1LJ; für Rechtslenker	03.0655-0101.2	370008	ATE
VW - SCIROCCO Van (137) 06/08→05/14							
 Bremskraftverstärker							
1.4 TSi	90	08/08→05/14		09/08→; für Rechtslenker; +PR 1ZA / 1ZB / 1ZE / 1LJ	03.7848-9802.4	300344	ATE Ø 7 / 8" pneumatisch
				09/08→; für Linkslenker; +PR 1ZK	03.7860-8802.4	300291	ATE Ø 10" pneumatisch
				09/08→; für Linkslenker; +PR 1ZD / 1ZP	03.7863-3232.4	300307	ATE Ø 10" pneumatisch
				09/08→; für Linkslenker; +PR 1ZA / 1ZE / 1LJ	03.7863-3332.4	300308	ATE Ø 10" pneumatisch
1.4 TSi	118	06/08→05/14		08/08→; +PR 1ZA / 1ZB / 1ZE / 1LJ; für Rechtslenker	03.7848-9802.4	300344	ATE Ø 7 / 8" pneumatisch
				08/08→; +PR 1ZK; für Linkslenker	03.7860-8802.4	300291	ATE Ø 10" pneumatisch
				08/08→; +PR 1ZD / 1ZP; für Linkslenker	03.7863-3232.4	300307	ATE Ø 10" pneumatisch
				08/08→; +PR 1ZA / 1ZE / 1LJ; für Linkslenker	03.7863-3332.4	300308	ATE Ø 10" pneumatisch
2.0 TDi	103	08/08→05/14		10/08→; +PR 1ZA / 1ZB / 1ZE / 1LJ; für Rechtslenker	03.7848-9802.4	300344	ATE Ø 7 / 8" pneumatisch
				10/08→; +PR 1ZK; für Linkslenker	03.7860-8802.4	300291	ATE Ø 10" pneumatisch
				10/08→; +PR 1ZD / 1ZP; für Linkslenker	03.7863-3232.4	300307	ATE Ø 10" pneumatisch
				10/08→; +PR 1ZA / 1ZE / 1LJ; für Linkslenker	03.7863-3332.4	300308	ATE Ø 10" pneumatisch
2.0 TDi 2.0 TFSi	125 155	05/09→05/14 11/09→05/14		für Rechtslenker; +PR 1ZA / 1ZB / 1ZE / 1LJ	03.7848-9802.4	300344	ATE Ø 7 / 8" pneumatisch
				für Linkslenker; +PR 1ZK	03.7860-8802.4	300291	ATE Ø 10" pneumatisch
				für Linkslenker; +PR 1ZD / 1ZP	03.7863-3232.4	300307	ATE Ø 10" pneumatisch
				für Linkslenker; +PR 1ZA / 1ZE / 1LJ	03.7863-3332.4	300308	ATE Ø 10" pneumatisch
 Hauptbremszylinder							
1.4 TSi	90	08/08→05/14		09/08→; +PR 1ZD / 1ZP; für Linkslenker	03.2122-2129.3	010799	ATE Ø 22,2
				09/08→; +PR 1ZA / 1ZE / 1LJ / 1ZK; für Linkslenker	03.2123-3449.3	010808	ATE Ø 23,8
				09/08→; +PR 1ZD / 1ZP; für Rechtslenker	24.4152-0132.3	011025	ATE Ø 22,2 ohne Bremsflüssigkeitsbehälter
				09/08→; +PR 1ZA / 1ZE / 1LJ / 1ZK; für Rechtslenker	24.4153-0202.3	011027	ATE Ø 23,8 ohne Bremsflüssigkeitsbehälter
1.4 TSi	118	06/08→05/14		08/08→; +PR 1ZD / 1ZP; für Linkslenker	03.2122-2129.3	010799	ATE Ø 22,2
				08/08→; +PR 1ZA / 1ZE / 1LJ / 1ZK; für Linkslenker	03.2123-3449.3	010808	ATE Ø 23,8
				08/08→; +PR 1ZD / 1ZP; für Rechtslenker	24.4152-0132.3	011025	ATE Ø 22,2 ohne Bremsflüssigkeitsbehälter
				08/08→; +PR 1ZA / 1ZE / 1LJ / 1ZK; für Rechtslenker	24.4153-0202.3	011027	ATE Ø 23,8 ohne Bremsflüssigkeitsbehälter
2.0 TDi	103	08/08→05/14		10/08→; +PR 1ZD / 1ZP; für Linkslenker	03.2122-2129.3	010799	ATE Ø 22,2
				10/08→; +PR 1ZA / 1ZE / 1LJ / 1ZK; für Linkslenker	03.2123-3449.3	010808	ATE Ø 23,8
				10/08→; +PR 1ZD / 1ZP; für Rechtslenker	24.4152-0132.3	011025	ATE Ø 22,2 ohne Bremsflüssigkeitsbehälter
				10/08→; +PR 1ZA / 1ZE / 1LJ / 1ZK; für Rechtslenker	24.4153-0202.3	011027	ATE Ø 23,8 ohne Bremsflüssigkeitsbehälter
2.0 TDi 2.0 TFSi	125 155	05/09→05/14 11/09→05/14		für Linkslenker; +PR 1ZD / 1ZP	03.2122-2129.3	010799	ATE Ø 22,2
				für Linkslenker; +PR 1ZA / 1ZE / 1LJ / 1ZK	03.2123-3449.3	010808	ATE Ø 23,8
				für Rechtslenker; +PR 1ZD / 1ZP	24.4152-0132.3	011025	ATE Ø 22,2 ohne Bremsflüssigkeitsbehälter
				für Rechtslenker; +PR 1ZA / 1ZE / 1LJ / 1ZK	24.4153-0202.3	011027	ATE Ø 23,8 ohne Bremsflüssigkeitsbehälter
→							

	kw			 	! #			
VW - SCIROCCO Van (137) 06/08→05/14								
Drucksensor, Bremskraftverstärker								
1.4 TSi	90	08/08→05/14		09/08→; +PR 1ZD / 1ZP	03.0655-0101.2	370008	ATE	
				09/08→; +PR 1ZK	03.0655-0101.2	370008	ATE	
				09/08→; für Rechtslenker; +PR 1ZA / 1ZB / 1ZE / 1LJ	03.0655-0101.2	370008	ATE	
				09/08→; für Linkslenker; +PR 1ZA / 1ZE / 1LJ	03.0655-0101.2	370008	ATE	
1.4 TSi	118	06/08→05/14		08/08→; +PR 1ZK	03.0655-0101.2	370008	ATE	
				08/08→; +PR 1ZD / 1ZP	03.0655-0101.2	370008	ATE	
				08/08→; +PR 1ZA / 1ZB / 1ZE / 1LJ; für Rechtslenker	03.0655-0101.2	370008	ATE	
				08/08→; +PR 1ZA / 1ZE / 1LJ; für Linkslenker	03.0655-0101.2	370008	ATE	
2.0 TDi	103	08/08→05/14		10/08→; +PR 1ZD / 1ZP	03.0655-0101.2	370008	ATE	
				10/08→; +PR 1ZK	03.0655-0101.2	370008	ATE	
				10/08→; +PR 1ZA / 1ZB / 1ZE / 1LJ; für Rechtslenker	03.0655-0101.2	370008	ATE	
				10/08→; +PR 1ZA / 1ZE / 1LJ; für Linkslenker	03.0655-0101.2	370008	ATE	
2.0 TDi 2.0 TFSi	125	05/09→05/14		+PR 1ZD / 1ZP	03.0655-0101.2	370008	ATE	
			155	11/09→05/14		+PR 1ZK	03.0655-0101.2	370008
		für Rechtslenker; +PR 1ZA / 1ZB / 1ZE / 1LJ			03.0655-0101.2	370008	ATE	
		für Linkslenker; +PR 1ZA / 1ZE / 1LJ	03.0655-0101.2	370008	ATE			
VW - SHARAN (7M8, 7M9, 7M6) 05/95→05/10								
Bremskraftverstärker								
1.8 T 20V 1.9 TDI 2.0	110 66 85	09/97→03/10 09/95→03/10 09/95→03/10		7M-W-020919→; → 04/00; für Linkslenker	03.7755-1902.4	300138	ATE Ø 9 / 8" pneumatisch	
				05/02→; - ESP; für Linkslenker	03.7755-6302.4	300221	ATE Ø 9 / 8" pneumatisch	
				05/00→ 04/02; +PR 1AT	03.7755-6302.4	300221	ATE Ø 9 / 8" pneumatisch	
				→ 7M-W-020918; für Rechtslenker	03.7760-3002.4	300120	ATE Ø 10" pneumatisch	
				→ 7M-W-060000; für Linkslenker	03.7760-3002.4	300120	ATE Ø 10" pneumatisch	
				05/00→; für Linkslenker; + ESP; → 7M-3-029999	03.7858-3302.4	300122	ATE Ø 9 / 8" pneumatisch	
				7M-3-030000→; + ESP; für Linkslenker	03.7858-9502.4	300205	ATE Ø 9 / 8" pneumatisch	
				7M-W-020919→; für Linkslenker	03.7755-1902.4	300138	ATE Ø 9 / 8" pneumatisch	
1.9 TDI 2.8 VR6 2.8 VR6 Syncro	81 128 128	09/96→04/00 09/95→04/00 11/96→04/00		→ 7M-W-060000; für Linkslenker	03.7760-3002.4	300120	ATE Ø 10" pneumatisch	
				→ 7M-W-020918; für Rechtslenker	03.7760-3002.4	300120	ATE Ø 10" pneumatisch	
				→ 7M-W-060000; für Linkslenker	03.7760-3002.4	300120	ATE Ø 10" pneumatisch	
1.9 TDI 1.9 TDI 4motion	85 85	04/00→03/10 03/00→03/10		05/02→; - ESP; für Linkslenker	03.7755-6302.4	300221	ATE Ø 9 / 8" pneumatisch	
				05/00→ 04/02; +PR 1AT	03.7755-6302.4	300221	ATE Ø 9 / 8" pneumatisch	
				05/00→; für Linkslenker; + ESP; → 7M-3-029999	03.7858-3302.4	300122	ATE Ø 9 / 8" pneumatisch	
				7M-3-030000→; + ESP; für Linkslenker	03.7858-9502.4	300205	ATE Ø 9 / 8" pneumatisch	
1.9 TDI 2.0 TDI	96 - 110 100 - 103	11/02→03/10 11/05→03/10		- ESP; für Linkslenker	03.7755-6302.4	300221	ATE Ø 9 / 8" pneumatisch	
				+ ESP; für Linkslenker	03.7858-9502.4	300205	ATE Ø 9 / 8" pneumatisch	
2.0 16V	110	09/95→02/00		7M-W-020919→; für Linkslenker	03.7755-1902.4	300138	ATE Ø 9 / 8" pneumatisch	
				→ 7M-W-020918; für Rechtslenker	03.7760-3002.4	300120	ATE Ø 10" pneumatisch	
				→ 7M-W-060000; für Linkslenker	03.7760-3002.4	300120	ATE Ø 10" pneumatisch	
				7M-3-030000→; + ESP; für Linkslenker	03.7858-9502.4	300205	ATE Ø 9 / 8" pneumatisch	
2.0 LPG	85	04/06→03/10		- ESP; für Linkslenker	03.7755-6302.4	300221	ATE Ø 9 / 8" pneumatisch	
				→ 7M-W-020918; für Rechtslenker	03.7760-3002.4	300120	ATE Ø 10" pneumatisch	
				→ 7M-W-060000; für Linkslenker	03.7760-3002.4	300120	ATE Ø 10" pneumatisch	
				für Linkslenker; + ESP; → 7M-3-029999	03.7858-3302.4	300122	ATE Ø 9 / 8" pneumatisch	
				7M-3-030000→; + ESP; für Linkslenker	03.7858-9502.4	300205	ATE Ø 9 / 8" pneumatisch	
2.8 V6 24V 2.8 V6 24V 4motion	150 150	04/00→03/10 04/00→03/10		05/02→; - ESP; für Linkslenker	03.7755-6302.4	300221	ATE Ø 9 / 8" pneumatisch	
				→ 04/02; +PR 1AT	03.7755-6302.4	300221	ATE Ø 9 / 8" pneumatisch	
				für Linkslenker; + ESP; → 7M-3-029999	03.7858-3302.4	300122	ATE Ø 9 / 8" pneumatisch	
				7M-3-030000→; + ESP; für Linkslenker	03.7858-9502.4	300205	ATE Ø 9 / 8" pneumatisch	
Pedalwegsensor, Bremspedal								
1.8 T 20V 1.9 TDI 1.9 TDI 4motion 2.0 →	110 66 - 85 85 85	09/97→03/10 09/95→03/10 03/00→03/10 09/95→03/10		7M-3-030364→; für Rechtslenker; + ESP	03.0655-0006.2	370006	ATE	
				7M-3-030000→; + ESP; für Linkslenker	03.0655-0006.2	370006	ATE	



VW - SHARAN (7M8, 7M9, 7M6) 05/95→05/10

Pedalwegsensor, Bremspedal

2.0 16V	110	09/95→02/00		7M-3-030364→; für Rechtslenker; + ESP	03.0655-0006.2	370006	ATE
2.0 LPG	85	04/06→03/10					
2.8 V6 24V	150	04/00→03/10		7M-3-030000→; + ESP; für Linkslenker	03.0655-0006.2	370006	ATE
2.8 V6 24V 4motion	150	04/00→03/10					
1.9 TDI	96 - 110	11/02→03/10		+ ESP; für Linkslenker	03.0655-0006.2	370006	ATE
2.0 TDI	100 - 103	11/05→03/10					

Hauptbremszylinder

1.8 T 20V	110	09/97→03/10		→ 7M-W-020918; + ABS	03.2123-1526.3	010477	Ø 23,8
				→ 7M-W-020918; - ABS	03.2123-1548.3	010478	Ø 23,8
				05/02→; - ESP; für Rechtslenker	03.2125-0332.3	010952	Ø 25,4
				7M-W-020919→; - ESP; → 04/02	03.2125-0332.3	010952	Ø 25,4
				7M-W-020919→; → 04/00; - ABS	03.2125-8404.3	010583	ATE Ø 25,4
				05/00→; + ESP; → 7M-3-029999	03.2125-9604.3	010581	Ø 25,4
1.9 TDI 2.0	66 85	09/95→03/10 09/95→03/10		→ 7M-W-020918; + ABS	03.2123-1526.3	010477	Ø 23,8
				→ 7M-W-020918; - ABS	03.2123-1548.3	010478	Ø 23,8
				05/02→; - ESP; für Rechtslenker; → 05/05	03.2125-0332.3	010952	Ø 25,4
				7M-W-020919→; - ESP; → 04/02	03.2125-0332.3	010952	Ø 25,4
				7M-W-020919→; → 04/00; - ABS	03.2125-8404.3	010583	ATE Ø 25,4
				05/00→; + ESP; → 7M-3-029999	03.2125-9604.3	010581	Ø 25,4
1.9 TDI 2.0 16V 2.8 VR6 2.8 VR6 Syncro	81 110 128 128	09/96→04/00 09/95→02/00 09/95→04/00 11/96→04/00		→ 7M-W-020918; + ABS	03.2123-1526.3	010477	Ø 23,8
				→ 7M-W-020918; - ABS	03.2123-1548.3	010478	Ø 23,8
				7M-W-020919→; - ESP	03.2125-0332.3	010952	Ø 25,4
				7M-W-020919→; - ABS	03.2125-8404.3	010583	ATE Ø 25,4
1.9 TDI 1.9 TDI 4motion	85 85	04/00→03/10 03/00→03/10		05/02→; - ESP; für Rechtslenker; → 05/05	03.2125-0332.3	010952	Ø 25,4
				05/00→; + ESP; → 7M-3-029999	03.2125-9604.3	010581	Ø 25,4
1.9 TDI	96	11/02→03/10		- ESP; für Rechtslenker; → 05/05	03.2125-0332.3	010952	Ø 25,4
2.0 LPG	85	04/06→03/10		→ 7M-W-020918; + ABS	03.2123-1526.3	010477	Ø 23,8
				→ 7M-W-020918; - ABS	03.2123-1548.3	010478	Ø 23,8
				+ ESP; → 7M-3-029999	03.2125-9604.3	010581	Ø 25,4
2.8 V6 24V 2.8 V6 24V 4motion	150 150	04/00→03/10 04/00→03/10		+ ESP; → 7M-3-029999	03.2125-9604.3	010581	Ø 25,4

Verschlusschraube, Hauptbremszylinder

1.8 T 20V 1.9 TDI 2.0 2.0 16V 2.0 LPG 2.8 VR6 2.8 VR6 Syncro	110 66 - 81 85 110 85 128 128	09/97→03/10 09/95→03/10 09/95→03/10 09/95→02/00 04/06→03/10 09/95→04/00 11/96→04/00		→ 7M-W-020918	03.3517-5100.1	390326	
--	---	---	--	---------------	----------------	--------	--















VW - SHARAN (7N1, 7N2) 05/10→11/22













Bremskraftverstärker











1.4 TSI 2.0 TDI	110 100 - 103	05/10→11/15 05/10→11/15		07/10→; für Linkslenker	03.7873-4502.4	300284	ATE Ø 11" pneumatisch
2.0 TDI	85 - 130	05/10→06/22		für Linkslenker	03.7873-4502.4	300284	ATE Ø 11" pneumatisch
2.0 TDI 4motion 2.0 TFSI	103 147	05/11→11/15 12/10→11/15					











Hauptbremszylinder







1.4 TSI 2.0 TDI	110 100 - 103	05/10→11/15 05/10→11/15		07/10→; für Linkslenker	03.4153-0186.3	010816	ATE Ø 23,8
				07/10→; für Rechtslenker	24.4153-0222.3	011047	ATE Ø 23,8 ohne Bremsflüssigkeitsbehälter
1.4 TSI 2.0 TDI	110 85 - 135	05/15→11/22 05/10→06/22		für Linkslenker	03.4153-0186.3	010816	ATE Ø 23,8
				für Rechtslenker	24.4153-0222.3	011047	ATE Ø 23,8 ohne Bremsflüssigkeitsbehälter
2.0 TDI 4motion 2.0 TFSI 2.0 TSI	103 - 162	05/11→10/20 12/10→11/15 05/15→12/20					











	kw					! #		
VW - SHARAN VAN (7M_) 05/95→03/10								
 Bremskraftverstärker								
1.9 TDI	66 - 96	09/96→03/10		- ESP; für Linkslenker		03.7755-6302.4	300221	ATE Ø 9 / 8" pneumatisch
2.0	85	09/96→07/02		+ ESP; für Linkslenker		03.7858-9502.4	300205	ATE Ø 9 / 8" pneumatisch
2.8 VR6	128	09/96→04/00						
2.8 VR6	150	08/01→05/03		7M-W-020919→; für Linkslenker		03.7755-1902.4	300138	ATE Ø 9 / 8" pneumatisch
				- ESP; für Linkslenker		03.7755-6302.4	300221	ATE Ø 9 / 8" pneumatisch
				→ 7M-W-060000; für Linkslenker		03.7760-3002.4	300120	ATE Ø 10" pneumatisch
				→ 7M-W-020918; für Rechtslenker		03.7760-3002.4	300120	ATE Ø 10" pneumatisch
				+ ESP; für Linkslenker		03.7858-9502.4	300205	ATE Ø 9 / 8" pneumatisch
Pedalwegsensor, Bremspedal								
1.9 TDI	66 - 96	09/96→03/10		+ ESP; für Linkslenker		03.0655-0006.2	370006	ATE
2.0	85	09/96→07/02						
2.8 VR6	128 - 150	09/96→05/03						
 Hauptbremszylinder								
1.9 TDI	66 - 96	09/96→03/10		- ESP; für Rechtslenker		03.2125-0332.3	010952	Ø 25,4
2.0	85	09/96→07/02						
2.8 VR6	128	09/96→04/00						
2.8 VR6	150	08/01→05/03		→ 7M-W-020918; + ABS		03.2123-1526.3	010477	Ø 23,8
				→ 7M-W-020918; - ABS		03.2123-1548.3	010478	Ø 23,8
				7M-W-020919→; - ESP		03.2125-0332.3	010952	Ø 25,4
				7M-W-020919→; - ABS		03.2125-8404.3	010583	ATE Ø 25,4
Verschlusschraube, Hauptbremszylinder								
2.8 VR6	150	08/01→05/03		→ 7M-W-020918		03.3517-5100.1	390326	
VW - SHARAN VAN (7N1, 7N2) 05/10→								
 Bremskraftverstärker								
1.4 TSI	110	05/10→11/15		07/10→; für Linkslenker		03.7873-4502.4	300284	ATE Ø 11" pneumatisch
2.0 TDI	100 - 103	05/10→11/15						
2.0 TDI	85 - 125	08/10→11/15		für Linkslenker		03.7873-4502.4	300284	ATE Ø 11" pneumatisch
2.0 TSI	147	12/10→11/15						
 Hauptbremszylinder								
1.4 TSI	110	05/10→11/15		07/10→; für Linkslenker		03.4153-0186.3	010816	ATE Ø 23,8
2.0 TDI	100 - 103	05/10→11/15		07/10→; für Rechtslenker		24.4153-0222.3	011047	ATE Ø 23,8 ohne Bremsflüssigkeitsbehälter
2.0 TDI	85 - 125	08/10→11/15		für Linkslenker		03.4153-0186.3	010816	ATE Ø 23,8
2.0 TSI	147	12/10→11/15		für Rechtslenker		24.4153-0222.3	011047	ATE Ø 23,8 ohne Bremsflüssigkeitsbehälter
VW - TAIGO (CS1) 09/21→								
 Hauptbremszylinder								
1.0 TSI	70 - 85	09/21→		für Linkslenker		24.2123-1782.3	011146	TRW Ø 23,8 ohne Bremsflüssigkeitsbehälter
1.5 TSI	110	09/21→						
VW - TAOS (CL1, CP1, CQ1) 07/20→								
 Hauptbremszylinder								
1.4 TSI	110	10/20→		08/21→		24.2123-1782.3	011146	TRW Ø 23,8 ohne Bremsflüssigkeitsbehälter
1.4 TSI 4motion	110	05/21→						
1.6 MPI	81	07/21→				24.2123-1782.3	011146	TRW Ø 23,8 ohne Bremsflüssigkeitsbehälter
VW - TIGUAN (5N_) 09/07→07/18								
 Bremskraftverstärker								
1.4 TSI	90 - 118	05/08→07/18		für Linkslenker		03.7873-4502.4	300284	ATE Ø 11" pneumatisch
1.4 TSI 4motion	110 - 118	09/07→07/18						
2.0 TDI	81 - 110	03/08→07/18						
2.0 TDI 4motion	100 - 135	11/07→07/18						
2.0 TFSI	147	11/07→07/18						











	kw			 	! #		
VW - TIGUAN (5N_) 09/07→07/18							
 Bremskraftverstärker							
2.0 TFSI 4motion 2.0 TSI 4motion	125 132 - 155	09/07→07/18 05/11→07/18		für Linkslenker		03.7873-4502.4 300284	ATE Ø 11" pneumatisch
2.0 TDI 4motion	103	09/07→07/18		11/07→; für Linkslenker		03.7873-4502.4 300284	ATE Ø 11" pneumatisch
2.0 TDI 4motion	125	09/07→07/18		01/08→; für Linkslenker		03.7873-4502.4 300284	ATE Ø 11" pneumatisch
2.0 TFSI 4motion	147	09/07→07/18		02/08→; für Linkslenker		03.7873-4502.4 300284	ATE Ø 11" pneumatisch
 Hauptbremszylinder							
1.4 TSI 1.4 TSI 4motion	90 - 118 110 - 118	05/08→07/18 09/07→07/18		für Linkslenker für Rechtslenker		03.4153-0186.3 010816 24.4153-0192.3 011026	ATE Ø 23,8 ATE Ø 23,8 ohne Bremsflüssigkeitsbehälter
2.0 TDI 2.0 TDI 4motion	81 - 110 100 - 135	03/08→07/18 11/07→07/18					
2.0 TFSI 2.0 TFSI 4motion 2.0 TSI 4motion	147 125 132 - 155	11/07→07/18 09/07→07/18 05/11→07/18					
2.0 TDI 4motion	103	09/07→07/18		11/07→; für Linkslenker		03.4153-0186.3 010816	ATE Ø 23,8
				11/07→; für Rechtslenker		24.4153-0192.3 011026	ATE Ø 23,8 ohne Bremsflüssigkeitsbehälter
2.0 TDI 4motion	125	09/07→07/18		01/08→; für Linkslenker		03.4153-0186.3 010816	ATE Ø 23,8
				01/08→; für Rechtslenker		24.4153-0192.3 011026	ATE Ø 23,8 ohne Bremsflüssigkeitsbehälter
2.0 TFSI 4motion	147	09/07→07/18		02/08→; für Linkslenker		03.4153-0186.3 010816	ATE Ø 23,8
				02/08→; für Rechtslenker		24.4153-0192.3 011026	ATE Ø 23,8 ohne Bremsflüssigkeitsbehälter
VW - TIGUAN (AD1, AX1) 01/16→							
 Hauptbremszylinder							
1.4 TSI 1.4 TSI 4motion 1.5 TSI	92 - 110 110 96 - 110	01/16→03/22 05/16→07/18 07/18→		für Linkslenker; +PR 1ZA / 1ZD		24.4123-1719.3 011017	TRW Ø 23,8 ohne Bremsflüssigkeitsbehälter
1.6 TDI 2.0 TDI	85 81 - 90	05/16→06/20 05/16→					
2.0 TDI 4motion 2.0 TSI 4motion	130 - 176 132 - 180	04/16→ 01/16→					
2.0 TSI R 4motion	235	11/20→					
2.0 TDI 2.0 TDI 4motion	110 110	01/16→07/20 01/16→07/20		02/16→; für Linkslenker; +PR 1ZA / 1ZD		24.4123-1719.3 011017	TRW Ø 23,8 ohne Bremsflüssigkeitsbehälter
VW - TIGUAN Kasten/SUV (AD1) 07/15→							
 Hauptbremszylinder							
TDI BlueMotion	140	01/16→07/20		für Linkslenker; +PR 1ZA / 1ZD		24.4123-1719.3 011017	TRW Ø 23,8 ohne Bremsflüssigkeitsbehälter
VW - TIGUAN VAN (5N_) 09/07→07/18							
 Bremskraftverstärker							
1.4 TSI 1.4 TSI 4motion 2.0 TDI	90 - 118 118 - 81 - 103	05/08→07/18 09/12→07/18 11/09→07/18		für Linkslenker		03.7873-4502.4 300284	ATE Ø 11" pneumatisch
2.0 TDI 4motion 2.0 TSI 4motion	103 - 130 125 - 155	11/07→07/18 11/09→07/18					
 Hauptbremszylinder							
1.4 TSI 1.4 TSI 4motion 2.0 TDI	90 - 118 118 - 81 - 103	05/08→07/18 09/12→07/18 11/09→07/18		für Linkslenker für Rechtslenker		03.4153-0186.3 010816 24.4153-0192.3 011026	ATE Ø 23,8 ATE Ø 23,8 ohne Bremsflüssigkeitsbehälter
2.0 TDI 4motion 2.0 TSI 4motion	103 - 130 125 - 155	11/07→07/18 11/09→07/18					

	kw					! #		
VW - TOUAREG (7LA, 7L6, 7L7) 10/02→01/13								
 Bremskraftverstärker								
2.5 R5 TDI	120 - 128	01/03→05/10		12/06→; für Linkslenker; → 03/10; +PR 1LB / 1LE / 1LF		03.7868-3702.4	300208	ATE Ø 10 / 8" pneumatisch
3.0 TDI	155	04/06→05/10						
3.0 V6 TDI	165	11/04→05/10						
3.6 V6 FSI	206	10/05→05/10						
4.2 V8 FSI	257	06/06→05/10						
5.0 V10 TDI	230	10/02→05/10						
3.0 V6 TDI	176	11/07→05/10		→ 03/10; für Linkslenker; +PR 1LB / 1LE / 1LF		03.7868-3702.4	300208	ATE Ø 10 / 8" pneumatisch
5.0 R50 TDI	257	08/07→05/10		01/08→ 03/10; für Linkslenker; +PR 1LB / 1LE / 1LF		03.7868-3702.4	300208	ATE Ø 10 / 8" pneumatisch
Pedalwegsensoren, Bremspedal								
2.5 R5 TDI	120 - 128	01/03→05/10		→ 11/06		03.0655-0006.2	370006	ATE
3.0 TDI	155	04/06→05/10						
3.0 V6 TDI	165	11/04→05/10						
6.0 W12	331	08/04→05/10						
3.2 V6	162	10/02→11/06		11/02→ 12/05		03.0655-0006.2	370006	ATE
3.2 V6	177	11/04→11/06		→ 12/05		03.0655-0006.2	370006	ATE
3.6 V6 FSI	206	10/05→05/10		01/06→ 11/06		03.0655-0006.2	370006	ATE
4.2 V8	228	12/02→11/06				03.0655-0006.2	370006	ATE
5.0 V10 TDI	230	10/02→05/10		11/02→ 11/06		03.0655-0006.2	370006	ATE
 Hauptbremszylinder								
2.5 R5 TDI	120 - 128	01/03→05/10		für Linkslenker; → 03/10		03.2126-3014.3	010811	ATE Ø 27
3.0 TDI	155	04/06→05/10		für Rechtslenker; → 11/06		24.2126-3032.3	011036	ATE Ø 27 ohne Bremsflüssigkeitsbehälter
3.0 V6 TDI	165	11/04→05/10						
3.0 V6 TDI	176	11/07→05/10		für Linkslenker		03.2126-3014.3	010811	ATE Ø 27
4.2 V8	228	12/02→11/06		für Rechtslenker		24.2126-3032.3	011036	ATE Ø 27 ohne Bremsflüssigkeitsbehälter
3.2 V6	162	10/02→11/06		11/02→; für Linkslenker; → 12/05		03.2126-3014.3	010811	ATE Ø 27
				11/02→; für Rechtslenker		24.2126-3032.3	011036	ATE Ø 27 ohne Bremsflüssigkeitsbehälter
3.2 V6	177	11/04→11/06		für Linkslenker; → 12/05		03.2126-3014.3	010811	ATE Ø 27
				für Rechtslenker		24.2126-3032.3	011036	ATE Ø 27 ohne Bremsflüssigkeitsbehälter
3.6 V6 FSI	206	10/05→05/10		01/06→ 03/10; für Linkslenker		03.2126-3014.3	010811	ATE Ø 27
				01/06→ 11/06; für Rechtslenker		24.2126-3032.3	011036	ATE Ø 27 ohne Bremsflüssigkeitsbehälter
4.2 V8 FSI	257	06/06→05/10		12/06→ 03/10; für Linkslenker		03.2126-3014.3	010811	ATE Ø 27
5.0 R50 TDI	257	08/07→05/10		01/08→ 03/10; für Linkslenker		03.2126-3014.3	010811	ATE Ø 27
5.0 V10 TDI	230	10/02→05/10		11/02→; für Linkslenker; → 03/10		03.2126-3014.3	010811	ATE Ø 27
				11/02→; für Rechtslenker; → 11/06		24.2126-3032.3	011036	ATE Ø 27 ohne Bremsflüssigkeitsbehälter
6.0 W12	331	08/04→05/10		für Linkslenker; → 11/06		03.2126-3014.3	010811	ATE Ø 27
				für Rechtslenker; → 11/06		24.2126-3032.3	011036	ATE Ø 27 ohne Bremsflüssigkeitsbehälter
VW - TOURAN (1T1, 1T2) 02/03→01/11								
 Bremskraftverstärker								
1.4 TSI	103	02/06→05/10		09/06→; +PR 1AT; für Linkslenker		03.7873-4302.4	300312	ATE Ø 11" pneumatisch
1.4 TSI	125	11/06→05/10						
1.4 TSI EcoFuel	110	05/09→05/10		für Linkslenker; +PR 1AT		03.7873-4302.4	300312	ATE Ø 11" pneumatisch
1.6	75	07/03→05/10						
1.6 BiFuel	75	11/06→05/10						
1.6 FSI	85	02/03→01/07						
1.9 TDI	66 - 77	02/03→05/10						
2.0 EcoFuel	80	02/06→05/09						
2.0 FSI	110	10/03→01/07						
2.0 TDI	103	12/05→05/10						
2.0 TDI 16V	103	08/03→05/10						
2.0 TDI	100	02/03→05/10		08/03→; für Linkslenker; +PR 1AT		03.7873-4302.4	300312	ATE Ø 11" pneumatisch
2.0 TDI	125	12/05→05/10		02/06→; +PR 1AT; für Linkslenker		03.7873-4302.4	300312	ATE Ø 11" pneumatisch
 Hauptbremszylinder								
1.4 TSI	103	02/06→05/10		09/06→; +PR 1ZE / 1ZP; für Linkslenker		03.2122-2129.3	010799	ATE Ø 22,2
				1T-6-100 001→; für Rechtslenker		24.4152-0132.3	011025	ATE Ø 22,2 ohne Bremsflüssigkeitsbehälter
→								

	kw			 	! #		
VW - TOURAN (1T1, 1T2) 02/03→01/11							
 Hauptbremszylinder							
1.4 TSI	125	11/06→05/10		für Linkslenker; +PR 1ZE / 1ZP	03.2122-2129.3	010799	ATE Ø 22,2
1.6	75	07/03→05/10		→ 1T-6-100 000; für Rechtslenker; +PR 1ZE / 1ZP	24.2122-1981.3	011024	ATE Ø 22,2 ohne Bremsflüssigkeitsbehälter
1.6 BiFuel	75	11/06→05/10					
1.9 TDI	66 - 77	02/03→05/10		1T-6-100 001→; für Rechtslenker	24.4152-0132.3	011025	ATE Ø 22,2 ohne Bremsflüssigkeitsbehälter
2.0 EcoFuel	80	02/06→05/09					
2.0 FSI	110	10/03→01/07					
2.0 TDI	103	12/05→05/10					
2.0 TDI 16V	103	08/03→05/10					
1.4 TSI EcoFuel	110	05/09→05/10		für Linkslenker	03.2122-2129.3	010799	ATE Ø 22,2
1.6 FSI	85	02/03→01/07		→ 1T-6-100 000; für Rechtslenker; +PR 1ZE / 1ZP	24.2122-1981.3	011024	ATE Ø 22,2 ohne Bremsflüssigkeitsbehälter
				1T-6-100 001→; für Rechtslenker	24.4152-0132.3	011025	ATE Ø 22,2 ohne Bremsflüssigkeitsbehälter
2.0 TDI	100	02/03→05/10		08/03→; für Linkslenker; +PR 1ZE / 1ZP	03.2122-2129.3	010799	ATE Ø 22,2
				08/03→; → 1T-6-100 000; für Rechtslenker; +PR 1ZE / 1ZP	24.2122-1981.3	011024	ATE Ø 22,2 ohne Bremsflüssigkeitsbehälter
				1T-6-100 001→; für Rechtslenker	24.4152-0132.3	011025	ATE Ø 22,2 ohne Bremsflüssigkeitsbehälter
2.0 TDI	125	12/05→05/10		02/06→; für Linkslenker; +PR 1ZE / 1ZP	03.2122-2129.3	010799	ATE Ø 22,2
				02/06→; → 1T-6-100 000; +PR 1ZE / 1ZP; für Rechtslenker	24.2122-1981.3	011024	ATE Ø 22,2 ohne Bremsflüssigkeitsbehälter
				1T-6-100 001→; für Rechtslenker	24.4152-0132.3	011025	ATE Ø 22,2 ohne Bremsflüssigkeitsbehälter
Drucksensor, Bremskraftverstärker							
1.4 TSI	103	02/06→05/10		09/06→; +PR 1AS; für Rechtslenker	03.0655-0101.2	370008	ATE
1.4 TSI	125	11/06→05/10		für Rechtslenker; +PR 1AS	03.0655-0101.2	370008	ATE
1.4 TSI EcoFuel	110	05/09→05/10					
1.6	75	07/03→05/10					
1.6 BiFuel	75	11/06→05/10					
1.6 FSI	85	02/03→01/07					
1.9 TDI	66 - 77	02/03→05/10					
2.0 EcoFuel	80	02/06→05/09					
2.0 FSI	110	10/03→01/07					
2.0 TDI	103	12/05→05/10					
2.0 TDI 16V	103	08/03→05/10					
2.0 TDI	100	02/03→05/10					
2.0 TDI	125	12/05→05/10		02/06→; +PR 1AS; für Rechtslenker	03.0655-0101.2	370008	ATE
VW - TOURAN (1T3) 05/10→09/16							
 Bremskraftverstärker							
1.2 TSI	77	05/10→05/15		für Linkslenker; +PR 1AT	03.7873-4302.4	300312	ATE Ø 11" pneumatisch
1.4 TSI	103 - 125	05/10→05/15					
1.4 TSI EcoFuel	110	05/10→05/15					
1.6 TDI	66 - 77	05/10→05/15					
2.0 TDI	81 - 125	05/10→05/15					
2.0 TDI	130	01/13→05/15					
 Hauptbremszylinder							
1.2 TSI	77	05/10→05/15		für Linkslenker; +PR 1ZE / 1ZP	03.2122-2129.3	010799	ATE Ø 22,2
1.4 TSI	125	05/10→05/15		→ 1T-6-100 000; für Rechtslenker; +PR 1ZE / 1ZP	24.2122-1981.3	011024	ATE Ø 22,2 ohne Bremsflüssigkeitsbehälter
1.6 TDI	66 - 77	05/10→05/15					
2.0 TDI	81 - 125	05/10→05/15		1T-6-100 001→; für Rechtslenker	24.4152-0132.3	011025	ATE Ø 22,2 ohne Bremsflüssigkeitsbehälter
1.4 TSI	103	05/10→05/15		für Linkslenker; +PR 1ZE / 1ZP	03.2122-2129.3	010799	ATE Ø 22,2
				1T-6-100 001→; für Rechtslenker	24.4152-0132.3	011025	ATE Ø 22,2 ohne Bremsflüssigkeitsbehälter
1.4 TSI EcoFuel	110	05/10→05/15		für Linkslenker	03.2122-2129.3	010799	ATE Ø 22,2
				→ 1T-6-100 000; für Rechtslenker; +PR 1ZE / 1ZP	24.2122-1981.3	011024	ATE Ø 22,2 ohne Bremsflüssigkeitsbehälter
				1T-6-100 001→; für Rechtslenker	24.4152-0132.3	011025	ATE Ø 22,2 ohne Bremsflüssigkeitsbehälter
2.0 TDI	130	01/13→05/15		für Linkslenker	03.2122-2129.3	010799	ATE Ø 22,2
				für Rechtslenker	24.4152-0132.3	011025	ATE Ø 22,2 ohne Bremsflüssigkeitsbehälter
→							

	kw					! #		
VW - TOURAN (1T3) 05/10→09/16								
Drucksensor, Bremskraftverstärker								
1.2 TSI	77	05/10→05/15		für Rechtslenker; +PR 1AS		03.0655-0101.2	370008	ATE
1.4 TSI	103 - 125	05/10→05/15						
1.4 TSI EcoFuel	110	05/10→05/15						
1.6 TDI	66 - 77	05/10→05/15						
2.0 TDI	81 - 125	05/10→05/15						
VW - TOURAN (5T1) 05/15→								
Hauptbremszylinder								
1.0 TSI	85	12/18→		für Linkslenker		24.4123-1719.3	011017	TRW Ø 23,8 ohne Bremsflüssigkeitsbehälter
1.2 TSI	81	05/15→						
1.4 TSI	110	05/15→						
1.5 TSI	110	11/18→				24.4153-1522.3	011048	ATE Ø 23,8 ohne Bremsflüssigkeitsbehälter
1.6 TDI	81 - 85	05/15→						
1.8 TSI	132	11/15→						
2.0 TDI	81 - 140	05/15→						
VW - TOURAN VAN (1T1, 1T2) 02/03→05/10								
Bremskraftverstärker								
1.9 TDI	66 - 77	08/03→05/10		+PR 1AT; für Linkslenker		03.7873-4302.4	300312	ATE Ø 11" pneumatisch
2.0 EcoFuel	80	02/06→11/06						
2.0 FSI	110	05/04→01/07						
2.0 TDi	103	08/03→05/10						
FSI	85	02/03→11/06						
2.0 TDI	100	02/03→05/10		08/03→; für Linkslenker; +PR 1AT		03.7873-4302.4	300312	ATE Ø 11" pneumatisch
Hauptbremszylinder								
1.9 TDI	66 - 77	08/03→05/10		für Linkslenker; +PR 1ZE / 1ZP		03.2122-2129.3	010799	ATE Ø 22,2
2.0 EcoFuel	80	02/06→11/06		→ 1T-6-100 000; +PR 1ZE / 1ZP; für Rechtslenker		24.2122-1981.3	011024	ATE Ø 22,2 ohne Bremsflüssigkeitsbehälter
2.0 FSI	110	05/04→01/07						
2.0 TDi	103	08/03→05/10		1T-6-100 001→; für Rechtslenker		24.4152-0132.3	011025	ATE Ø 22,2 ohne Bremsflüssigkeitsbehälter
2.0 TDI	100	02/03→05/10		08/03→; für Linkslenker; +PR 1ZE / 1ZP		03.2122-2129.3	010799	ATE Ø 22,2
				08/03→; → 1T-6-100 000; für Rechtslenker; +PR 1ZE / 1ZP		24.2122-1981.3	011024	ATE Ø 22,2 ohne Bremsflüssigkeitsbehälter
				1T-6-100 001→; für Rechtslenker		24.4152-0132.3	011025	ATE Ø 22,2 ohne Bremsflüssigkeitsbehälter
FSI	85	02/03→11/06		für Linkslenker		03.2122-2129.3	010799	ATE Ø 22,2
				→ 1T-6-100 000; +PR 1ZE / 1ZP; für Rechtslenker		24.2122-1981.3	011024	ATE Ø 22,2 ohne Bremsflüssigkeitsbehälter
				1T-6-100 001→; für Rechtslenker		24.4152-0132.3	011025	ATE Ø 22,2 ohne Bremsflüssigkeitsbehälter
Drucksensor, Bremskraftverstärker								
1.9 TDI	66 - 77	08/03→05/10		+PR 1AS; für Rechtslenker		03.0655-0101.2	370008	ATE
2.0 EcoFuel	80	02/06→11/06						
2.0 FSI	110	05/04→01/07						
2.0 TDi	103	08/03→05/10						
FSI	85	02/03→11/06						
2.0 TDI	100	02/03→05/10		08/03→; für Rechtslenker; +PR 1AS		03.0655-0101.2	370008	ATE
VW - TOURAN VAN (1T3) 05/10→05/15								
Bremskraftverstärker								
1.2 TSI	77	05/10→05/15		für Linkslenker; +PR 1AT		03.7873-4302.4	300312	ATE Ø 11" pneumatisch
1.4 TSI	103 - 125	05/10→05/15						
1.4 TSi EcoFuel	110	05/10→05/15						
1.6 TDI	66 - 77	05/10→05/15						
2.0 TDi	125	05/10→01/13						
2.0 TDI	103	05/10→05/15						
Hauptbremszylinder								
1.2 TSI	77	05/10→05/15		für Linkslenker; +PR 1ZE / 1ZP		03.2122-2129.3	010799	ATE Ø 22,2
1.4 TSI	103 - 125	05/10→05/15		→ 1T-6-100 000; für Rechtslenker; +PR 1ZE / 1ZP		24.2122-1981.3	011024	ATE Ø 22,2 ohne Bremsflüssigkeitsbehälter
1.4 TSi EcoFuel	110	05/10→05/15						
→								

	kw					! #		
VW - TOURAN VAN (1T3) 05/10→05/15								
 Hauptbremszylinder								
1.6 TDI	66	05/10→05/15		1T-6-100 001→; für Rechtslenker		24.4152-0132.3	011025	ATE Ø 22,2 ohne Bremsflüssigkeitsbehälter
2.0 TDi	77	05/10→01/13						
2.0 TDI	103	05/10→05/15						
Drucksensor, Bremskraftverstärker								
1.2 TSI	77	05/10→05/15		für Rechtslenker; +PR 1AS		03.0655-0101.2	370008	ATE
1.4 TSI	103 - 125	05/10→05/15						
1.4 TSi EcoFuel	110	05/10→05/15						
1.6 TDI	66 - 77	05/10→05/15						
2.0 TDi	125	05/10→01/13						
2.0 TDI	103	05/10→05/15						
VW - TOURAN VAN (5T1) 05/15→								
 Hauptbremszylinder								
2.0 TDI	90 - 110	11/20→		für Linkslenker		24.4123-1719.3	011017	TRW Ø 23,8 ohne Bremsflüssigkeitsbehälter
						24.4153-1522.3	011048	ATE Ø 23,8 ohne Bremsflüssigkeitsbehälter
VW - TRANSPORTER T4 Bus (70B, 70C, 7DB, 7DK, 70J, 70K, 7DC, 7DJ) 09/90→10/04								
 Bremskraftverstärker								
1.9 TD	50	10/92→04/03		→ 70-S-127805		03.7750-7402.4	300084	ATE Ø 9" pneumatisch
2.0	62	09/90→04/03		07/95→; für Rechtslenker; → 70-T-199000		03.7750-7402.4	300084	ATE Ø 9" pneumatisch
2.5	81	09/90→06/03						
2.5 Syncro	81	08/92→04/03		70-T-200001→		03.7755-4202.4	300164	ATE Ø 9 / 8" pneumatisch
				07/95→; für Linkslenker; → 70-T-199000		03.7755-4202.4	300164	ATE Ø 9 / 8" pneumatisch
				70-S-127806→; → 06/95		03.7755-4202.4	300164	ATE Ø 9 / 8" pneumatisch
2.4 D	55	08/97→04/03		→ 70-S-127805		03.7750-7402.4	300084	ATE Ø 9" pneumatisch
2.5	85	08/96→04/03		für Rechtslenker; → 70-T-199000		03.7750-7402.4	300084	ATE Ø 9" pneumatisch
2.5 Syncro	85	07/96→04/03		70-T-200001→		03.7755-4202.4	300164	ATE Ø 9 / 8" pneumatisch
				für Linkslenker; → 70-T-199000		03.7755-4202.4	300164	ATE Ø 9 / 8" pneumatisch
2.5 TDI	65 - 111	09/95→04/03		für Rechtslenker; → 70-T-199000		03.7750-7402.4	300084	ATE Ø 9" pneumatisch
2.5 TDI Syncro	75	01/96→04/03		70-T-200001→		03.7755-4202.4	300164	ATE Ø 9 / 8" pneumatisch
2.8 VR6	150	04/00→04/03		für Linkslenker; → 70-T-199000		03.7755-4202.4	300164	ATE Ø 9 / 8" pneumatisch
2.8 VR 6	103	11/95→04/00						
 Hauptbremszylinder								
1.9 TD	50	10/92→04/03		→ 70-S-127805; für Linkslenker; - ABS		03.2122-1042.3	010137	Ø 22,2
2.0	62	09/90→04/03		70-S-127806→; + ABS; Herstellereinschränkung nur für TRW-Søttel		03.2123-1526.3	010477	Ø 23,8
2.5	81	09/90→06/03						
2.5 Syncro	81	08/92→04/03		70-S-127806→; für Linkslenker; - ABS; Herstellereinschränkung nur für TRW-Søttel		03.2123-1548.3	010478	Ø 23,8
				05/96→; - ABS; +PR 1LU; Herstellereinschränkung nur für Ate-Søttel		03.2125-8111.3	010479	Ø 25,4
				05/96→; - ESP; Herstellereinschränkung nur für Ate-Søttel		03.2125-9704.3	010603	ATE Ø 25,4
				70-Y-027264→; + ESP; Herstellereinschränkung nur für Ate-Søttel		03.2125-9704.3	010603	ATE Ø 25,4
2.4 D	55	08/97→04/03		→ 70-S-127805; für Linkslenker; - ABS		03.2122-1042.3	010137	Ø 22,2
2.5	85	08/96→04/03		70-S-127806→; + ABS; Herstellereinschränkung nur für TRW-Søttel		03.2123-1526.3	010477	Ø 23,8
2.5 Syncro	85	07/96→04/03		70-S-127806→; für Linkslenker; - ABS; Herstellereinschränkung nur für TRW-Søttel		03.2123-1548.3	010478	Ø 23,8
				- ABS; +PR 1LU; Herstellereinschränkung nur für Ate-Søttel		03.2125-8111.3	010479	Ø 25,4
				- ESP; Herstellereinschränkung nur für Ate-Søttel		03.2125-9704.3	010603	ATE Ø 25,4
				70-Y-027264→; + ESP; Herstellereinschränkung nur für Ate-Søttel		03.2125-9704.3	010603	ATE Ø 25,4
2.5 TDI	65 - 111	05/98→04/03		+ ABS; Herstellereinschränkung nur für TRW-Søttel		03.2123-1526.3	010477	Ø 23,8
2.8 VR6	150	04/00→04/03		für Linkslenker; - ABS; Herstellereinschränkung nur für TRW-Søttel		03.2123-1548.3	010478	Ø 23,8
				- ABS; +PR 1LU; Herstellereinschränkung nur für Ate-Søttel		03.2125-8111.3	010479	Ø 25,4
→								

	kw					! #		
VW - TRANSPORTER T4 Bus (70B, 70C, 7DB, 7DK, 70J, 70K, 7DC, 7DJ) 09/90→10/04								
 Hauptbremszylinder								
2.5 TDI	65 - 111	05/98→04/03		70-Y-027264→; + ESP; Herstellereinschränkung nur für Ate-Sattel		03.2125-9704.3	010603	ATE Ø 25,4
2.8 VR6	150	04/00→04/03		- ESP; Herstellereinschränkung nur für Ate-Sattel		03.2125-9704.3	010603	ATE Ø 25,4
2.5 TDI	75	09/95→04/03		+ ABS; Herstellereinschränkung nur für TRW-Sattel		03.2123-1526.3	010477	Ø 23,8
				für Linkslenker; - ABS; Herstellereinschränkung nur für TRW-Sattel		03.2123-1548.3	010478	Ø 23,8
				05/96→; - ABS; +PR 1LU; Herstellereinschränkung nur für Ate-Sattel		03.2125-8111.3	010479	Ø 25,4
				70-Y-027264→; + ESP; Herstellereinschränkung nur für Ate-Sattel		03.2125-9704.3	010603	ATE Ø 25,4
				05/96→; - ESP; Herstellereinschränkung nur für Ate-Sattel		03.2125-9704.3	010603	ATE Ø 25,4
2.5 TDI Syncro	75	01/96→04/03		für Linkslenker; - ABS; Herstellereinschränkung nur für TRW-Sattel		03.2123-1548.3	010478	Ø 23,8
				05/96→; - ABS; +PR 1LU; Herstellereinschränkung nur für Ate-Sattel		03.2125-8111.3	010479	Ø 25,4
				05/96→; - ESP; Herstellereinschränkung nur für Ate-Sattel		03.2125-9704.3	010603	ATE Ø 25,4
				70-Y-027264→; + ESP; Herstellereinschränkung nur für Ate-Sattel		03.2125-9704.3	010603	ATE Ø 25,4
2.8 VR 6	103	11/95→04/00		+ ABS; Herstellereinschränkung nur für TRW-Sattel		03.2123-1526.3	010477	Ø 23,8
				für Linkslenker; - ABS; Herstellereinschränkung nur für TRW-Sattel		03.2123-1548.3	010478	Ø 23,8
				- ABS; +PR 1LU; Herstellereinschränkung nur für Ate-Sattel		03.2125-8111.3	010479	Ø 25,4
				70-Y-027264→; + ESP; Herstellereinschränkung nur für Ate-Sattel		03.2125-9704.3	010603	ATE Ø 25,4
				05/96→; - ESP; Herstellereinschränkung nur für Ate-Sattel		03.2125-9704.3	010603	ATE Ø 25,4
Verschlusschraube, Hauptbremszylinder								
1.9 TD	50	10/92→04/03		→ 70-S-127805; für Linkslenker; - ABS		03.3517-0101.2	390322	
2.0	62	09/90→04/03						
2.4 D	55	08/97→04/03						
2.5	81 - 85	09/90→06/03						
2.5 Syncro	81 - 85	08/92→04/03						
VW - TRANSPORTER T4 Kasten (70A, 70H, 7DA, 7DH) 07/90→04/03								
 Bremskraftverstärker								
1.9 TD	50	10/92→04/03		→ 70-S-127805		03.7750-7402.4	300084	ATE Ø 9" pneumatisch
2.0	62	07/90→04/03		07/95→; für Rechtslenker; → 70-T-199000		03.7750-7402.4	300084	ATE Ø 9" pneumatisch
				70-T-200001→		03.7755-4202.4	300164	ATE Ø 9 / 8" pneumatisch
				07/95→; für Linkslenker; → 70-T-199000		03.7755-4202.4	300164	ATE Ø 9 / 8" pneumatisch
				70-S-127806→; → 06/95		03.7755-4202.4	300164	ATE Ø 9 / 8" pneumatisch
2.4 D	55	08/97→04/03		→ 70-S-127805		03.7750-7402.4	300084	ATE Ø 9" pneumatisch
2.5 Syncro	85	08/96→04/03		für Rechtslenker; → 70-T-199000		03.7750-7402.4	300084	ATE Ø 9" pneumatisch
				70-T-200001→		03.7755-4202.4	300164	ATE Ø 9 / 8" pneumatisch
				für Linkslenker; → 70-T-199000		03.7755-4202.4	300164	ATE Ø 9 / 8" pneumatisch
2.5 Syncro	81	11/92→11/01		→ 70-S-127805		03.7750-7402.4	300084	ATE Ø 9" pneumatisch
				für Rechtslenker; → 70-T-199000		03.7750-7402.4	300084	ATE Ø 9" pneumatisch
				70-S-127806→		03.7755-4202.4	300164	ATE Ø 9 / 8" pneumatisch
				70-T-200001→		03.7755-4202.4	300164	ATE Ø 9 / 8" pneumatisch
				für Linkslenker; → 70-T-199000		03.7755-4202.4	300164	ATE Ø 9 / 8" pneumatisch
2.5 TDI	65 - 111	09/95→04/03		für Rechtslenker; → 70-T-199000		03.7750-7402.4	300084	ATE Ø 9" pneumatisch
				70-T-200001→		03.7755-4202.4	300164	ATE Ø 9 / 8" pneumatisch
				für Linkslenker; → 70-T-199000		03.7755-4202.4	300164	ATE Ø 9 / 8" pneumatisch
2.5 TDI Syncro	75	09/95→04/03						
2.8 VR6	103 - 150	05/96→04/03		für Linkslenker; → 70-T-199000		03.7755-4202.4	300164	ATE Ø 9 / 8" pneumatisch
 Hauptbremszylinder								
1.9 TD	50	10/92→04/03		→ 70-S-127805; für Linkslenker; - ABS		03.2122-1042.3	010137	Ø 22,2
2.0	62	07/90→04/03		70-S-127806→; + ABS; Herstellereinschränkung nur für TRW-Sattel		03.2123-1526.3	010477	Ø 23,8
2.5	81	11/90→04/03						
2.5 Syncro	81	11/92→11/01						
				70-S-127806→; für Linkslenker; - ABS; Herstellereinschränkung nur für TRW-Sattel		03.2123-1548.3	010478	Ø 23,8
→								

VW - TRANSPORTER T4 Kasten (70A, 70H, 7DA, 7DH) 07/90→04/03

Hauptbremszylinder

1.9 TD 2.0 2.5 2.5 Syncro	50	10/92→04/03		05/96→; - ABS; +PR 1LU; Herstellereinschränkung nur für Ate-Sattel	03.2125-8111.3	010479	Ø 25,4
	62	07/90→04/03					
	81	11/90→04/03		05/96→; - ESP; Herstellereinschränkung nur für Ate-Sattel	03.2125-9704.3	010603	ATE Ø 25,4
	81	11/92→11/01		70-Y-027264→; + ESP; Herstellereinschränkung nur für Ate-Sattel	03.2125-9704.3	010603	ATE Ø 25,4
2.4 D 2.5 2.5 Syncro	55	08/97→04/03		→ 70-S-127805; für Linkslenker; - ABS	03.2122-1042.3	010137	Ø 22,2
	85	08/96→04/03		70-S-127806→; + ABS; Herstellereinschränkung nur für TRW-Sattel	03.2123-1526.3	010477	Ø 23,8
	85	08/96→04/03		70-S-127806→; für Linkslenker; - ABS; Herstellereinschränkung nur für TRW-Sattel	03.2123-1548.3	010478	Ø 23,8
				- ABS; +PR 1LU; Herstellereinschränkung nur für Ate-Sattel	03.2125-8111.3	010479	Ø 25,4
				- ESP; Herstellereinschränkung nur für Ate-Sattel	03.2125-9704.3	010603	ATE Ø 25,4
				70-Y-027264→; + ESP; Herstellereinschränkung nur für Ate-Sattel	03.2125-9704.3	010603	ATE Ø 25,4
2.5 TDI 2.8 VR6	65 - 111	12/98→04/03		+ ABS; Herstellereinschränkung nur für TRW-Sattel	03.2123-1526.3	010477	Ø 23,8
	103 - 150	05/96→04/03		für Linkslenker; - ABS; Herstellereinschränkung nur für TRW-Sattel	03.2123-1548.3	010478	Ø 23,8
				- ABS; +PR 1LU; Herstellereinschränkung nur für Ate-Sattel	03.2125-8111.3	010479	Ø 25,4
				70-Y-027264→; + ESP; Herstellereinschränkung nur für Ate-Sattel	03.2125-9704.3	010603	ATE Ø 25,4
2.5 TDI	75	09/95→04/03		+ ABS; Herstellereinschränkung nur für TRW-Sattel	03.2123-1526.3	010477	Ø 23,8
				für Linkslenker; - ABS; Herstellereinschränkung nur für TRW-Sattel	03.2123-1548.3	010478	Ø 23,8
				05/96→; - ABS; +PR 1LU; Herstellereinschränkung nur für Ate-Sattel	03.2125-8111.3	010479	Ø 25,4
				70-Y-027264→; + ESP; Herstellereinschränkung nur für Ate-Sattel	03.2125-9704.3	010603	ATE Ø 25,4
				05/96→; - ESP; Herstellereinschränkung nur für Ate-Sattel	03.2125-9704.3	010603	ATE Ø 25,4
2.5 TDI Syncro	75	09/95→04/03		für Linkslenker; - ABS; Herstellereinschränkung nur für TRW-Sattel	03.2123-1548.3	010478	Ø 23,8
				05/96→; - ABS; +PR 1LU; Herstellereinschränkung nur für Ate-Sattel	03.2125-8111.3	010479	Ø 25,4
				05/96→; - ESP; Herstellereinschränkung nur für Ate-Sattel	03.2125-9704.3	010603	ATE Ø 25,4
				70-Y-027264→; + ESP; Herstellereinschränkung nur für Ate-Sattel	03.2125-9704.3	010603	ATE Ø 25,4









Verschlusschraube, Hauptbremszylinder

1.9 TD 2.0 2.4 D 2.5 2.5 Syncro	50	10/92→04/03		→ 70-S-127805; für Linkslenker; - ABS	03.3517-0101.2	390322	
	62	07/90→04/03					
	55	08/97→04/03					
	81 - 85	11/90→04/03					
	81 - 85	11/92→04/03					
	85						

VW - TRANSPORTER T4 Pritsche/Fahrgestell (70E, 70L, 70M, 7DE, 7DL 07/90→04/03

Bremskraftverstärker

1.9 TD 2.0 2.5 2.5 Syncro	50	10/92→04/03		→ 70-S-127805	03.7750-7402.4	300084	ATE Ø 9" pneumatisch
	62	07/90→04/03		07/95→; für Rechtslenker; → 70-T-199000	03.7750-7402.4	300084	ATE Ø 9" pneumatisch
	81	11/90→04/03		70-T-200001→	03.7755-4202.4	300164	ATE Ø 9 / 8" pneumatisch
	81	11/92→11/01		07/95→; für Linkslenker; → 70-T-199000	03.7755-4202.4	300164	ATE Ø 9 / 8" pneumatisch
				70-S-127806→; → 06/95	03.7755-4202.4	300164	ATE Ø 9 / 8" pneumatisch
2.4 D 2.5 2.5 Syncro	55	08/97→04/03		→ 70-S-127805	03.7750-7402.4	300084	ATE Ø 9" pneumatisch
	85	08/96→04/03		für Rechtslenker; → 70-T-199000	03.7750-7402.4	300084	ATE Ø 9" pneumatisch
	85	08/96→04/03		70-T-200001→	03.7755-4202.4	300164	ATE Ø 9 / 8" pneumatisch
2.5 TDI 2.5 TDI Syncro	65 - 75	09/95→04/03		für Rechtslenker; → 70-T-199000	03.7750-7402.4	300084	ATE Ø 9" pneumatisch
	75	05/98→04/03		70-T-200001→	03.7755-4202.4	300164	ATE Ø 9 / 8" pneumatisch
	75			für Linkslenker; → 70-T-199000	03.7755-4202.4	300164	ATE Ø 9 / 8" pneumatisch
→							

	kw					! #		
VW - TRANSPORTER T4 Pritsche/Fahrgestell (70E, 70L, 70M, 7DE, 7DL 07/90→04/03)								
 Hauptbremszylinder								
1.9 TD	50	10/92→04/03		→ 70-S-127805; für Linkslenker; - ABS		03.2122-1042.3	010137	Ø 22,2
2.0	62	07/90→04/03		70-S-127806→; + ABS; Herstellereinschränkung nur für TRW-Sattel		03.2123-1526.3	010477	Ø 23,8
2.5	81	11/90→04/03		70-S-127806→; für Linkslenker; - ABS; Herstellereinschränkung nur für TRW-Sattel		03.2123-1548.3	010478	Ø 23,8
2.5 Syncro	81	11/92→11/01		05/96→; - ABS; +PR 1LU; Herstellereinschränkung nur für Ate-Sattel		03.2125-8111.3	010479	Ø 25,4
				05/96→; - ESP; Herstellereinschränkung nur für Ate-Sattel		03.2125-9704.3	010603	ATE Ø 25,4
				70-Y-027264→; + ESP; Herstellereinschränkung nur für Ate-Sattel		03.2125-9704.3	010603	ATE Ø 25,4
2.4 D	55	08/97→04/03		→ 70-S-127805; für Linkslenker; - ABS		03.2122-1042.3	010137	Ø 22,2
2.5	85	08/96→04/03		70-S-127806→; + ABS; Herstellereinschränkung nur für TRW-Sattel		03.2123-1526.3	010477	Ø 23,8
2.5 Syncro	85	08/96→04/03		70-S-127806→; für Linkslenker; - ABS; Herstellereinschränkung nur für TRW-Sattel		03.2123-1548.3	010478	Ø 23,8
				- ABS; +PR 1LU; Herstellereinschränkung nur für Ate-Sattel		03.2125-8111.3	010479	Ø 25,4
				- ESP; Herstellereinschränkung nur für Ate-Sattel		03.2125-9704.3	010603	ATE Ø 25,4
				70-Y-027264→; + ESP; Herstellereinschränkung nur für Ate-Sattel		03.2125-9704.3	010603	ATE Ø 25,4
2.5 TDI	65	05/98→04/03		+ ABS; Herstellereinschränkung nur für TRW-Sattel		03.2123-1526.3	010477	Ø 23,8
				für Linkslenker; - ABS; Herstellereinschränkung nur für TRW-Sattel		03.2123-1548.3	010478	Ø 23,8
				- ABS; +PR 1LU; Herstellereinschränkung nur für Ate-Sattel		03.2125-8111.3	010479	Ø 25,4
				70-Y-027264→; + ESP; Herstellereinschränkung nur für Ate-Sattel		03.2125-9704.3	010603	ATE Ø 25,4
				- ESP; Herstellereinschränkung nur für Ate-Sattel		03.2125-9704.3	010603	ATE Ø 25,4
2.5 TDI	75	09/95→04/03		+ ABS; Herstellereinschränkung nur für TRW-Sattel		03.2123-1526.3	010477	Ø 23,8
				für Linkslenker; - ABS; Herstellereinschränkung nur für TRW-Sattel		03.2123-1548.3	010478	Ø 23,8
				05/96→; - ABS; +PR 1LU; Herstellereinschränkung nur für Ate-Sattel		03.2125-8111.3	010479	Ø 25,4
				70-Y-027264→; + ESP; Herstellereinschränkung nur für Ate-Sattel		03.2125-9704.3	010603	ATE Ø 25,4
				05/96→; - ESP; Herstellereinschränkung nur für Ate-Sattel		03.2125-9704.3	010603	ATE Ø 25,4
2.5 TDI Syncro	75	05/98→04/03		für Linkslenker; - ABS; Herstellereinschränkung nur für TRW-Sattel		03.2123-1548.3	010478	Ø 23,8
				- ABS; +PR 1LU; Herstellereinschränkung nur für Ate-Sattel		03.2125-8111.3	010479	Ø 25,4
				- ESP; Herstellereinschränkung nur für Ate-Sattel		03.2125-9704.3	010603	ATE Ø 25,4
				70-Y-027264→; + ESP; Herstellereinschränkung nur für Ate-Sattel		03.2125-9704.3	010603	ATE Ø 25,4
Verschlusschraube, Hauptbremszylinder								
1.9 TD	50	10/92→04/03		→ 70-S-127805; für Linkslenker; - ABS		03.3517-0101.2	390322	
2.0	62	07/90→04/03						
2.4 D	55	08/97→04/03						
2.5	81 - 85	11/90→04/03						
2.5 Syncro	81 - 85	11/92→04/03						
VW - TRANSPORTER T5 Bus (7HB, 7HJ, 7EB, 7EJ) 04/03→03/16								
 Bremskraftverstärker								
1.9 TDI	62 - 77	04/03→11/09		+PR 1AJ / 1AE / 1AC / 1AR; → 7H-A-050000		03.7765-1002.4	300246	ATE Ø 10 / 9" pneumatisch
2.0	85	11/03→08/15		+PR 1AK; → 7H-A-050000		03.7868-3702.4	300208	ATE Ø 10 / 8" pneumatisch
2.0 BiTDI	132	09/09→08/15						
2.0 BiTDI 4motion	132	09/09→08/15						
2.0 CNG	85	01/06→08/15						
2.0 TDI	62 - 103	09/09→08/15						
2.0 TDI 4motion	103	09/09→08/15						
2.5 TDi	120	11/03→11/09						
2.5 TDI	96 - 128	04/03→11/09						
→								

VW - TRANSPORTER T5 Bus (7HB, 7HJ, 7EB, 7EJ) 04/03→03/16

Bremskraftverstärker

2.5 TDI 4motion	96 - 128	07/04→11/09		+PR 1AJ / 1AE / 1AC / 1AR; → 7H-A-050000	03.7765-1002.4	300246	ATE Ø 10 / 9" pneumatisch
VR6 3.2	173	02/04→11/09		+PR 1AK; → 7H-A-050000	03.7868-3702.4	300208	ATE Ø 10 / 8" pneumatisch
3.2 V6 4motion	173	11/03→12/09		07/04→; +PR 1AJ / 1AE / 1AC / 1AR; → 7H-A-050000	03.7765-1002.4	300246	ATE Ø 10 / 9" pneumatisch
				07/04→; +PR 1AK; → 7H-A-050000	03.7868-3702.4	300208	ATE Ø 10 / 8" pneumatisch

Pedalwegsensoren, Bremspedal

1.9 TDI	62 - 77	04/03→11/09		+PR 1AT; → 7H-A-050000	03.0655-0006.2	370006	ATE
2.0	85	11/03→08/15					
2.0 BiTDI	132	09/09→08/15					
2.0 BiTDI 4motion	132	09/09→08/15					
2.0 CNG	85	01/06→08/15					
2.0 TDI	62 - 103	09/09→08/15					
2.0 TDI 4motion	103	09/09→08/15					
2.5 TDi	120	11/03→11/09					
2.5 TDI	96 - 128	04/03→11/09					
2.5 TDI 4motion	96 - 128	07/04→11/09					
VR6 3.2	173	02/04→11/09					
3.2 V6 4motion	173	11/03→12/09		07/04→; +PR 1AT; → 7H-A-050000	03.0655-0006.2	370006	ATE

Hauptbremszylinder

1.9 TDI	62 - 77	04/03→11/09		→ 7H-A-050000	03.2126-3014.3	010811	ATE Ø 27
2.0	85	11/03→08/15		7H-6-000001→ 7H-6-200000; für Rechtslenker; +PR 1AT	03.2126-3014.3	010811	ATE Ø 27
2.0 CNG	85	01/06→08/15					
VR6 3.2	173	02/04→11/09		7H-A-200001→	03.2126-3144.3	010941	ATE Ø 27
2.0 BiTDI	132	09/09→08/15		→ 7H-A-050000	03.2126-3014.3	010811	ATE Ø 27
2.0 BiTDI 4motion	132	09/09→08/15					
2.0 TDI	62 - 103	09/09→08/15		7H-A-200001→	03.2126-3144.3	010941	ATE Ø 27
2.0 TDI 4motion	100 - 103	09/09→08/15					
2.5 TDi	120	11/03→11/09					
2.5 TDI	96 - 128	04/03→11/09					
2.5 TDI 4motion	96 - 128	07/04→11/09					
2.0 TDI	84 - 85	05/11→08/15			03.2126-3144.3	010941	ATE Ø 27
2.0 TSI	110 - 150	05/11→08/15					
2.0 TSI 4motion	150	07/11→08/15					
3.2 V6 4motion	173	11/03→12/09		07/04→; → 7H-A-050000	03.2126-3014.3	010811	ATE Ø 27
				7H-A-200001→	03.2126-3144.3	010941	ATE Ø 27











VW - TRANSPORTER T5 Kasten (7HA, 7HH, 7EA, 7EH) 04/03→











Bremskraftverstärker

1.9 TDI	62 - 77	04/03→11/09		+PR 1AJ / 1AE / 1AC / 1AR; → 7H-A-050000	03.7765-1002.4	300246	ATE Ø 10 / 9" pneumatisch
2.0	85	11/03→08/15		+PR 1AK; → 7H-A-050000	03.7868-3702.4	300208	ATE Ø 10 / 8" pneumatisch
2.0 BiFuel	85	06/07→08/15					
2.0 BiTDI	132	09/09→08/15					
2.0 BiTDI 4motion	132	09/09→08/15					
2.0 TDI	62 - 103	09/09→08/15					
2.0 TDI 4motion	103	09/09→08/15					
2.5 TDI	96 - 128	04/03→11/09					
2.5 TDI 4motion	96 - 128	07/04→11/09					
VR6 3.2	173	02/04→11/09					
VR6 3.2 4motion	173	11/03→11/09		07/04→; +PR 1AJ / 1AE / 1AC / 1AR; → 7H-A-050000	03.7765-1002.4	300246	ATE Ø 10 / 9" pneumatisch
				07/04→; +PR 1AK; → 7H-A-050000	03.7868-3702.4	300208	ATE Ø 10 / 8" pneumatisch

Pedalwegsensoren, Bremspedal

1.9 TDI	62 - 77	04/03→11/09		+PR 1AT; → 7H-A-050000	03.0655-0006.2	370006	ATE
2.0	85	11/03→08/15					
2.0 BiFuel	85	06/07→08/15					
2.0 BiTDI	132	09/09→08/15					
2.0 BiTDI 4motion	132	09/09→08/15					
→							

	kw					! #		
VW - TRANSPORTER T5 Kasten (7HA, 7HH, 7EA, 7EH) 04/03→								
Pedalwegsensord, Bremspedal								
2.0 TDI	62 - 103	09/09→08/15		+PR 1AT; → 7H-A-050000			03.0655-0006.2 370006	ATE
2.0 TDI 4motion	103	09/09→08/15						
2.5 TDI	96 - 128	04/03→11/09						
2.5 TDI 4motion	96 - 128	07/04→11/09						
VR6 3.2	173	02/04→11/09						
VR6 3.2 4motion	173	11/03→11/09		07/04→; +PR 1AT; → 7H-A-050000			03.0655-0006.2 370006	ATE
 Hauptbremszylinder								
1.9 TDI	62 - 77	04/03→11/09		→ 7H-A-050000			03.2126-3014.3 010811	ATE Ø 27
2.0	85	11/03→08/15		7H-6-000001→ 7H-6-200000; für Rechtslenker; +PR 1AT			03.2126-3014.3 010811	ATE Ø 27
2.0 BiFuel	85	06/07→08/15						
VR6 3.2	173	02/04→11/09		7H-A-200001→			03.2126-3144.3 010941	ATE Ø 27
2.0 BiTDI	132	09/09→08/15		→ 7H-A-050000			03.2126-3014.3 010811	ATE Ø 27
2.0 BiTDI 4motion	132	09/09→08/15						
2.0 TDI	62 - 103	09/09→08/15		7H-A-200001→			03.2126-3144.3 010941	ATE Ø 27
2.0 TDI 4motion	100 - 103	09/09→08/15						
2.5 TDI	96 - 128	04/03→11/09						
2.5 TDI 4motion	96 - 128	07/04→11/09						
2.0 TDI	84	05/11→08/15					03.2126-3144.3 010941	ATE Ø 27
2.0 TSI	110 - 150	05/11→08/15						
2.0 TSI 4motion	150	07/11→08/15						
VR6 3.2 4motion	173	11/03→11/09		07/04→; → 7H-A-050000			03.2126-3014.3 010811	ATE Ø 27
				7H-A-200001→			03.2126-3144.3 010941	ATE Ø 27
VW - TRANSPORTER T5 Pritsche/Fahrgestell (7JD, 7JE, 7JL, 7JY, 7JZ 04/03→03/16								
 Bremskraftverstärker								
1.9 TDI	62 - 77	04/03→11/09		→ 7J-A-010000; +PR 1AJ / 1AE / 1AC / 1AR			03.7765-1002.4 300246	ATE Ø 10 / 9" pneumatisch
2.0	85	11/03→05/13		→ 7J-A-010000; +PR 1AK			03.7868-3702.4 300208	ATE Ø 10 / 8" pneumatisch
2.0 BiTDI	132	09/09→08/15						
2.0 BiTDI 4motion	132	09/09→08/15						
2.0 CNG	85	11/03→05/11						
2.0 TDI	62 - 103	09/09→08/15						
2.0 TDI 4motion	103	09/09→08/15						
2.5 TDI	96 - 128	04/03→11/09						
2.5 TDI 4motion	96 - 128	07/04→11/09						
VR6 3.2	173	08/03→11/09						
2.5 TDI 4motion	128	04/04→11/09		07/04→; → 7J-A-010000; +PR 1AJ / 1AE / 1AC / 1AR			03.7765-1002.4 300246	ATE Ø 10 / 9" pneumatisch
				07/04→; → 7J-A-010000; +PR 1AK			03.7868-3702.4 300208	ATE Ø 10 / 8" pneumatisch
Pedalwegsensord, Bremspedal								
1.9 TDI	62 - 77	04/03→11/09		→ 7J-A-010000; +PR 1AT			03.0655-0006.2 370006	ATE
2.0	85	11/03→05/13						
2.0 BiTDI	132	09/09→08/15						
2.0 BiTDI 4motion	132	09/09→08/15						
2.0 CNG	85	11/03→05/11						
2.0 TDI	62 - 103	09/09→08/15						
2.0 TDI 4motion	103	09/09→08/15						
2.5 TDI	96 - 128	04/03→11/09						
2.5 TDI 4motion	96 - 128	07/04→11/09						
VR6 3.2	173	08/03→11/09						
2.5 TDI 4motion	128	04/04→11/09		07/04→; → 7J-A-010000; +PR 1AT			03.0655-0006.2 370006	ATE
 Hauptbremszylinder								
1.9 TDI	62 - 77	04/03→11/09		→ 7J-A-010000			03.2126-3014.3 010811	ATE Ø 27
2.0	85	11/03→05/13		7J-A-200001→			03.2126-3144.3 010941	ATE Ø 27
2.0 BiTDI	132	09/09→08/15						
2.0 BiTDI 4motion	132	09/09→08/15						
2.0 CNG	85	11/03→05/11						
2.0 TDI	62 - 103	09/09→08/15						
2.0 TDI 4motion	103	09/09→08/15						
→								

	kW			 	! #		
VW - TRANSPORTER T5 Pritsche/Fahrgestell (7JD, 7JE, 7JL, 7JY, 7JZ 04/03→03/16)							
 Hauptbremszylinder							
2.5 TDI	96 - 128	04/03→11/09		→ 7J-A-010000		03.2126-3014.3 010811	ATE Ø 27
2.5 TDI 4motion VR6 3.2	96 - 173	07/04→11/09 08/03→11/09		7J-A-200001→		03.2126-3144.3 010941	ATE Ø 27
2.0 TDI	84 - 100	05/10→08/15				03.2126-3144.3 010941	ATE Ø 27
2.0 TDI 4motion 2.0 TSI	100 - 110	05/10→08/15 07/12→08/15					
2.5 TDI 4motion	128	04/04→11/09		07/04→; → 7J-A-010000		03.2126-3014.3 010811	ATE Ø 27
				7J-A-200001→		03.2126-3144.3 010941	ATE Ø 27
VW - T-ROC (A11, D11) 07/17→							
 Hauptbremszylinder							
1.0 TSI 1.5 TSI	81 - 110	09/20→ 11/17→		für Linkslenker		24.2123-1782.3 011146	TRW Ø 23,8 ohne Bremsflüssigkeitsbehälter
1.5 TSI 4motion 1.6 TDI	110 - 85	05/18→11/19 03/18→06/21				24.4153-1522.3 011048	ATE Ø 23,8 ohne Bremsflüssigkeitsbehälter
2.0 R 4motion 2.0 TDI 2.0 TDI 4motion	221 - 110 - 140	09/19→ 03/18→ 09/17→					
2.0 TDI SCR	85	11/20→					
1.0 TSI 2.0 TSI 4motion	85 - 140	07/17→11/20 07/17→		09/17→; für Linkslenker		24.2123-1782.3 011146	TRW Ø 23,8 ohne Bremsflüssigkeitsbehälter
				für Linkslenker		24.4153-1522.3 011048	ATE Ø 23,8 ohne Bremsflüssigkeitsbehälter
VW - T-ROC Cabriolet (AC7, AC8) 12/19→							
 Hauptbremszylinder							
1.0 TSI 1.5 TSI	81 - 85 - 110	12/19→ 12/19→		für Linkslenker		24.4153-1522.3 011048	ATE Ø 23,8 ohne Bremsflüssigkeitsbehälter
VW - UP! (121, 122, BL1, BL2, BL3, 123) 08/11→							
 Hauptbremszylinder							
1.0	44 - 55	08/11→08/20		12/11→; für Linkslenker		24.4120-1703.3 011015	TRW Ø 20,6 ohne Bremsflüssigkeitsbehälter
1.0 1.0 EcoFuel 1.0 GTI 1.0 TSI	48 - 50 - 85 - 66	08/20→11/23 11/12→11/23 11/17→11/23 05/16→08/19		für Linkslenker		24.4120-1703.3 011015	TRW Ø 20,6 ohne Bremsflüssigkeitsbehälter



DE Technische Übersetzungen

EN Technical translations

ES Traducciones técnicas





FR Traductions techniques

IT Traduzioni tecniche

2025

Technische Übersetzungen

Technical translations - Traducciones tecnicas - Traductions techniques - Traduzioni tecniche

DE		DE	
	Hauptbremszylinder	Ausstattungs-Code	Ausstattungs-Code
	Bremskraftregler	Automatikgetriebe	Automatikgetriebe
	Bremskraftverstärker	BDX	Bremssystem, Bendix
	links	Bördelform	Bördelform
+ ABS	für Fahrzeuge mit ABS	BOS	Bremssystem, Bosch
+ ASR	für Fahrzeuge mit ASR	Bosnien-Herzegowina	Bosnien-Herzegowina
+ DSC	für Fahrzeuge mit DSC	Bremskraftverstärker	Bremskraftverstärker
+ DSTC	für Fahrzeuge mit DSTC	Brems-system	Bremssystem
+ EDS	für Fahrzeuge mit EDS	CVT-Automatikgetriebe (stufenlos)	CVT-Automatikgetriebe (stufenlos)
+ ESP	für Fahrzeuge mit ESP	DEL	Bremssystem, Delco
+ Performance Parts	für Fahrzeuge mit Performance Bremse	- Diff	ohne Differentialsperre
+PR	für PR-Nummer	- DSC	für Fahrzeuge ohne DSC
+ RO	Rumänien	- DSTC	für Fahrzeuge ohne DSTC
+SA	für Sonderausstattungscode (SA-Code)	E	E
+ TR	Türkei	empty/leer	Montageinformation beachten
12Q	12Q	- ESP	für Fahrzeuge ohne ESP
14,0	14,0	F	F
14Q	14Q	Fahrzeugproduktionsland	Fahrzeugproduktionsland
15,0	15,0	Felge Lochzahl	Felge Lochzahl
16Q	16Q	Felgengröße [Zoll]	Felgengröße [Zoll]
18,0	18,0	Frankreich	Frankreich
2019	2019	für DAM-Nummer ab	für DAM-Nummer ab
20Q	20Q	→	
3	3	für erhöhte Nutzlast	für erhöhte Nutzlast
4	4	für Facelift	für Facelift
5	5	für Fahr-schulwagen	für Fahrschulwagen
- ABS	für Fahrzeuge ohne ABS		
ALU	Aluminium		
Aluguss	Aluguss		
Artikel-nummer des empfohlenen Zubehörs	Artikelnummer des empfohlenen Zubehörs		
- ASR	für Fahrzeuge ohne ASR		

Technische Übersetzungen

Technical translations - Traducciones técnicas - Traductions techniques - Traduzioni tecniche

DE		DE	
für Fahrzeuge mit Adaptive Cruise Control	für Fahrzeuge mit Adaptive Cruise Control	für Fahrzeuge mit Sportfahrwerk	für Fahrzeuge mit Sportfahrwerk
für Fahrzeuge mit AMG-Sportpaket	für Fahrzeuge mit AMG-Sportpaket	für Fahrzeuge mit Sportpaket	für Fahrzeuge mit Sportpaket
für Fahrzeuge mit autom. Distanzregelung	für Fahrzeuge mit autom. Distanzregelung	für Fahrzeuge mit Start-Stopp-Funktion	für Fahrzeuge mit Start-Stopp-Funktion
für Fahrzeuge mit Bremsassistent	für Fahrzeuge mit Bremsassistent	für Fahrzeuge mit STC	für Fahrzeuge mit STC
für Fahrzeuge mit elektr. Dämpferregulierung	für Fahrzeuge mit elektr. Dämpferregulierung	für Fahrzeuge mit Trommelbremse an der Hinterachse	für Fahrzeuge mit Trommelbremse an der Hinterachse
für Fahrzeuge mit elektronischer Fahrdynamikregelung	für Fahrzeuge mit elektronischer Fahrdynamikregelung	für Fahrzeuge mit Vakuumpumpe	für Fahrzeuge mit Vakuumpumpe
für Fahrzeuge mit Kollisionswarner	für Fahrzeuge mit Kollisionswarner	für Fahrzeuge mit verstärktem Fahrwerk	für Fahrzeuge mit verstärktem Fahrwerk
für Fahrzeuge mit M-Sportbremse	für Fahrzeuge mit M-Sportbremse	für Fahrzeuge mit verstärkter Bremse	für Fahrzeuge mit verstärkter Bremse
für Fahrzeuge mit Rußpartikelfilter	für Fahrzeuge mit Rußpartikelfilter	für Fahrzeuge ohne Adaptive Cruise Control	für Fahrzeuge ohne Adaptive Cruise Control
für Fahrzeuge mit Scheibenbremse an der Hinterachse	für Fahrzeuge mit Scheibenbremse an der Hinterachse	für Fahrzeuge ohne Aktivlenkung	für Fahrzeuge ohne Aktivlenkung
für Fahrzeuge mit Servolenkung	für Fahrzeuge mit Servolenkung	für Fahrzeuge ohne AMG-Sportpaket	für Fahrzeuge ohne AMG-Sportpaket
		für Fahrzeuge ohne autom. Distanzregelung	für Fahrzeuge ohne autom. Distanzregelung



Technische Übersetzungen

Technical translations - Traducciones tecnicas - Traductions techniques - Traduzioni tecniche

DE		DE	
für Fahrzeuge ohne Bremsassistent	für Fahrzeuge ohne Bremsassistent	für Modellreihenbaumuster	für Modellreihenbaumuster
für Fahrzeuge ohne elektronische Fahrdynamikregelung	für Fahrzeuge ohne elektronische Fahrdynamikregelung	für OE-Nummer	für OE-Nummer
für Fahrzeuge ohne Keramikbremse	für Fahrzeuge ohne Keramikbremse	für Rechtslenker	für Rechtslenker
für Fahrzeuge ohne Kollisionswarner	für Fahrzeuge ohne Kollisionswarner	für verkürzten Radstand	für verkürzten Radstand
für Fahrzeuge ohne M-Sportbremse	für Fahrzeuge ohne M-Sportbremse	für verlängerten Radstand	für verlängerten Radstand
für Fahrzeuge ohne Servolenkung	für Fahrzeuge ohne Servolenkung	Getriebeautomatik 6 Gang	Getriebeautomatik 6 Gang
für Fahrzeuge ohne Sportfahrwerk	für Fahrzeuge ohne Sportfahrwerk	Gewindemaß 1	Gewindemaß 1
für Fahrzeuge ohne Sportpaket	für Fahrzeuge ohne Sportpaket	Gewindemaß 2	Gewindemaß 2
für Fahrzeuge ohne Start-Stopp-Funktion	für Fahrzeuge ohne Start-Stopp-Funktion	GG	Bremssattel aus Gusseisen
für Fahrzeuge ohne STC	für Fahrzeuge ohne STC	Herstellereinschränkung	Herstellereinschränkung
für Fahrzeuge ohne verstärktes Fahrwerk	für Fahrzeuge ohne verstärktes Fahrwerk	hyd.	hydraulisch
für Kolbendurchmesser [mm]	für Kolbendurchmesser [mm]	Japan	Japan
für Linkslenker	für Linkslenker	Kroatien	Kroatien
		L=	Länge [mm]
		L=	Länge über Alles [mm]
		L1=	Länge 1 [mm]
		L2=	Länge 2 [mm]
		lastabhängig	lastabhängig
		mit Bremsflüssigkeitsbehälter	mit Bremsflüssigkeitsbehälter
		mm Radnabendurchmesser [mm]	Radnabendurchmesser [mm]
		Motorcode	Motorcode
		nicht für Facelift	nicht für Facelift
		nicht für Fahrschulwagen	nicht für Fahrschulwagen

Technische Übersetzungen





Technical translations - Traducciones técnicas - Traductions techniques - Traduzioni tecniche

DE		DE	
nicht für Fahrzeuge mit verstärkter Bremse	nicht für Fahrzeuge mit verstärkter Bremse	Schaltgetriebe	Schaltgetriebe
nicht für gepanzerte Fahrzeuge	nicht für gepanzerte Fahrzeuge	Schaltgetriebe, automatisch betätigt	Schaltgetriebe, automatisch betätigt
nicht für Schaltgetriebe sequentiell	nicht für Schaltgetriebe sequentiell	Schaltgetriebe 6 Gang	Schaltgetriebe 6 Gang
nicht für Sonderfahrzeuge	nicht für Sonderfahrzeuge	Schaltgetriebe sequentiell	Schaltgetriebe sequentiell
Nutzlast [kg]	Nutzlast [kg]	Scheibenbremse	Scheibenbremse
Nutzlast ab [kg]	Nutzlast ab [kg]	Schlüsselweite 1 [mm]	Schlüsselweite 1 [mm]
Nutzlast bis [kg]	Nutzlast bis [kg]	Schrägheck	Schrägheck
Nutzlast-Code	Nutzlast-Code	Slowakische Republik	Slowakische Republik
Nutzlast leicht	Nutzlast leicht	Sonderausstattungscode (SA-Code) ab →	Sonderausstattungscode (SA-Code) ab →
Nutzlast schwer	Nutzlast schwer	Trommelbremse	Trommelbremse
ohne Bremsflüssigkeitsbehälter	ohne Bremsflüssigkeitsbehälter	TRW	Bremssystem, Lucas / TRW
ohne Druckregler	ohne Druckregler	Tschechische Republik	Tschechische Republik
ohne Drucksensor	ohne Drucksensor	Türenanzahl	Türenanzahl
ohne Steuergerät	ohne Steuergerät	Ungarn	Ungarn
Orga →	für Organisationsnummer ab	x	Anschlussanzahl
- Performance Parts	für Fahrzeuge ohne Performance Bremse	Zubehör	Zubehör
pneumatisch	pneumatisch	zusätzlich benötigter Artikel (Artikel-Nummer)	zusätzlich benötigter Artikel (Artikel-Nummer)
Radstand [mm]	Radstand [mm]	∅	Durchmesser [mm]
Republik Korea (Südkorea)	Republik Korea (Südkorea)	∅ "	Durchmesser [Zoll]
- RU	Russland	∅1	Durchmesser 1 [mm]
Satz	Satz	∅2	Durchmesser 2 [mm]
		→	Baujahr ab Fahrgestellnummer (VIN) ab
		→	Baujahr bis Fahrgestellnummer (VIN) bis



Technische Übersetzungen

Technical translations - Traducciones técnicas - Traductions techniques - Traduzioni tecniche

DE		EN	
→ Modelljahr bis	Modelljahr bis		Brake Master Cylinder
→ Orga	für Organisationsnummer bis		Brake Force Regulator
→ Sonderausstattungscode (SA-Code) bis	Sonderausstattungscode (SA-Code) bis		Brake Booster
			Left
		+ ABS	for vehicles with ABS
		+ ASR	for vehicles with ASR
		+ DSC	for vehicles with DSC
		+ DSTC	for vehicles with DSTC
		+ EDS	for vehicles with EDS
		+ ESP	for vehicles with ESP
		+ Performance Parts	for vehicles with Performance brakes
		+PR	for PR number
		+ RO	Romania
		+SA	for special equipment code
		+ TR	Turkey
		12Q	12Q
		14,0	14.0
		14Q	14Q
		15,0	15.0
		16Q	16Q
		18,0	18.0
		2019	2019
		20Q	20Q
		3	3
		4	4
		5	5
		- ABS	for vehicles without ABS
		ALU	Aluminium
		Aluguss	Cast Aluminium
		Artikelnummer des empfohlenen Zubehörs	Article number of recommended accessories
		- ASR	for vehicles without ASR

Technische Übersetzungen

Technical translations - Traducciones técnicas - Traductions techniques - Traduzioni tecniche

EN		EN	
Ausstattungs-Code	Equipment Code	für Fahrzeuge mit Adaptive Cruise Control	for vehicles with Adaptive Cruise Control
Automatikgetriebe	Automatic Transmission		
BDX	Brake System, Bendix	für Fahrzeuge mit AMG-Sportpaket	for vehicles with AMG Sports Package
Bördelform	Flange Shape		
BOS	Brake System, Bosch		
Bosnien-Herzegowina	Bosnia-Herzegovina	für Fahrzeuge mit autom. Distanzregelung	for vehicles with autom. distance control
Bremskraftverstärker	Brake Booster		
Bremsystem	Brake System		
CVT-Automatikgetriebe (stufenlos)	CVT automatic transmission (stepless)	für Fahrzeuge mit Bremsassistent	for vehicles with brake assist
DEL	Brake System, Delco	für Fahrzeuge mit elektr. Dämpferregulierung	for vehicles with electronic suspension control
- Diff	without differential lock		
- DSC	for vehicles without DSC		
- DSTC	for vehicles without DSTC		
E	E	für Fahrzeuge mit elektronischer Fahrdynamikregelung	for vehicles with electronic drive dynamics control
empty/leer	Observe mounting information		
- ESP	for vehicles without ESP		
F	F	für Fahrzeuge mit Kollisionswarner	for vehicles with collision warning system
Fahrzeugproduktionsland	Vehicle Production Country		
Felge Lochzahl	Rim Hole Number	für Fahrzeuge mit M-Sportbremse	for vehicles with M-sport brakes
Felgengröße [Zoll]	Rim Size [inch]		
Frankreich	France	für Fahrzeuge mit Rußpartikelfilter	for vehicles with soot particulate filter
für DAM-Nummer ab →	for DAM number from		
für erhöhte Nutzlast	for increased payload	für Fahrzeuge mit Scheibenbremse an der Hinterachse	for vehicles with disc brakes on the rear axle
für Facelift	for facelift		
für Fahr-schulwagen	for driving school cars		
		für Fahrzeuge mit Servolenkung	for vehicles with power steering



Technische Übersetzungen

Technical translations - Traducciones técnicas - Traductions techniques - Traduzioni tecniche

EN		EN	
für Fahrzeuge mit Sportfahrwerk	for vehicles with sports suspension	für Fahrzeuge ohne Bremsassistent	for vehicles without brake assist
für Fahrzeuge mit Sportpaket	for vehicles with sports package	für Fahrzeuge ohne elektronische Fahrdynamikregelung	for vehicles without electronic drive dynamics control
für Fahrzeuge mit Start-Stopp-Funktion	for vehicles with start-stop function	für Fahrzeuge ohne Keramikbremse	for vehicles without ceramic brakes
für Fahrzeuge mit STC	for vehicles with STC	für Fahrzeuge ohne Kollisionswarner	for vehicles without collision warning system
für Fahrzeuge mit Trommelbremse an der Hinterachse	for vehicles with drum brakes on the rear axle	für Fahrzeuge ohne M-Sportbremse	for vehicles without M-sport brakes
für Fahrzeuge mit Vakuumpumpe	for vehicles with vacuum pump	für Fahrzeuge ohne Servolenkung	for vehicles without power steering
für Fahrzeuge mit verstärktem Fahrwerk	for vehicles with heavy duty suspension	für Fahrzeuge ohne Sportfahrwerk	for vehicles without sports suspension
für Fahrzeuge mit verstärkter Bremse	for vehicles with reinforced brakes	für Fahrzeuge ohne Sportpaket	for vehicles without sports package
für Fahrzeuge ohne Adaptive Cruise Control	for vehicles without Adaptive Cruise Control	für Fahrzeuge ohne Start-Stopp-Funktion	for vehicles without start-stop function
für Fahrzeuge ohne Aktivlenkung	for vehicles without active steering	für Fahrzeuge ohne STC	for vehicles without STC
für Fahrzeuge ohne AMG-Sportpaket	for vehicles without AMG sports package	für Fahrzeuge ohne verstärktes Fahrwerk	for vehicles without heavy duty suspension
für Fahrzeuge ohne autom. Distanzregelung	for vehicles without autom. distance control	für Kolbendurchmesser [mm]	for piston diameter [mm]
		für Linkslenker	for left-hand drive vehicles

Technische Übersetzungen

Technical translations - Traducciones tecnicas - Traductions techniques - Traduzioni tecniche

EN	EN
für Modellreihenbaumuster for model code	nicht für Fahrzeuge mit verstärkter Bremse not for vehicles with reinforced brakes
für OE-Nummer for OE number	nicht für gepanzerte Fahrzeuge not for armoured vehicles
für Rechtslenker for right-hand drive vehicles	nicht für Schaltgetriebe sequentiell not for sequential manual transmission
für verkürzten Radstand for shortened wheelbase	nicht für Sonderfahrzeuge not for special-purpose vehicles
für verlängerten Radstand for extended wheelbase	Nutzlast [kg] Payload [kg]
Getriebeautomatik 6 Gang 6-Speed Automatic Transmission	Nutzlast ab [kg] Payload from [kg]
Gewindemaß 1 Thread Size 1	Nutzlast bis [kg] Payload to [kg]
Gewindemaß 2 Thread Size 2	Nutzlast-Code Payload code
GG Cast iron brake caliper	Nutzlast leicht Payload light
Herstellereinschränkung Manufacturer Restriction	Nutzlast schwer Payload heavy
hyd. Hydraulic	ohne Bremsflüssigkeitsbehälter without brake fluid reservoir
Japan Japan	ohne Druckregler without pressure regulator
Kroatien Croatia	ohne Drucksensor without pressure sensor
L= Length [mm]	ohne Steuergerät without control unit
L= Overall Length [mm]	Orga → for RPO number from
L1= Length 1 [mm]	- Performance Parts for vehicles without Performance brakes
L2= Length 2 [mm]	pneumatisch pneumatic
lastabhängig Load-dependent	Radstand [mm] Wheelbase [mm]
mit Bremsflüssigkeitsbehälter with brake fluid reservoir	Republik Korea (Südkorea) Republic of Korea (South Korea)
mm Radnabendurchmesser [mm] Wheel Hub Diameter [mm]	- RU Russia
Motorcode Engine Code	Satz Set
nicht für Facelift not for facelift	
nicht für Fahrschulwagen not for driving school cars	







Technische Übersetzungen

Technical translations - Traducciones tecnicas - Traductions techniques - Traduzioni tecniche

EN		EN	
Schaltgetriebe	Manual Transmission	→	Construction Year to Vehicle Identification Number (VIN) to
Schaltgetriebe, automatisch betätigt	Manual Transmission, automatically operated	→ Modelljahr bis	Model Year to
Schaltgetriebe 6 Gang	6-Speed Manual Transmission	→ Orga	for RPO number up to
Schaltgetriebe sequentiell	Sequential Manual Transmission	→ Sonderausstattungscode (SA-Code) bis	Special equipment code up to
Scheibenbremse	Disc Brake		
Schlüsselweite 1 [mm]	Spanner Size 1 [mm]		
Schrägheck	Hatchback		
Slowakische Republik	Slovakia		
Sonderausstattungscode (SA-Code) ab	special equipment code from		
→			
Trommelbremse	Drum Brake		
TRW	Brake System, Lucas / TRW		
Tschechische Republik	Czech Republic		
Türenanzahl	Number of Doors		
Ungarn	Hungary		
x	Number of connectors		
Zubehör	Accessories		
zusätzlich benötigter Artikel (Artikel-Nummer)	Additionally required articles (article numbers)		
Ø	Diameter [mm]		
Ø "	Diameter [inch]		
Ø1	Diameter 1 [mm]		
Ø2	Diameter 2 [mm]		
→	Construction Year from Vehicle Identification Number (VIN) from		

Technische Übersetzungen

Technical translations - Traducciones técnicas - Traductions techniques - Traduzioni tecniche

ES		ES	
	Cilindro principal de freno	Ausstattungs-Code	Código de equipamiento
	Regulador de la fuerza de frenado	Automatikgetriebe	Transmisión automática
	Servofrenos	BDX	Sistema de frenos, Bendix
	izquierda	Bördelform	Tipo rebordeado
+ ABS	para vehículos con ABS	BOS	Sistema de frenos, Bosch
+ ASR	para vehículos con ASR	Bosnien-Herzegowina	Bosnia y Herzegovina
+ DSC	para vehículos con DSC	Bremskraftverstärker	Servofrenos
+ DSTC	para vehículos con DSTC	Brems-system	Sistema de frenos
+ EDS	para vehículos con EDS	CVT-Automatikgetriebe (stufenlos)	Transmisión automática CVT (continua)
+ ESP	para vehículos con ESP	DEL	Sistema de frenos, Delco
+ Performance Parts	para vehículos con frenos alto rendimiento	- Diff	sin bloqueo de diferencial
+PR	Número de PR	- DSC	para vehículos sin DSC
+ RO	Rumania	- DSTC	Para vehículos sin DSCT
+SA	para código de equipamiento especial	E	E
+ TR	Turquía	empty/leer	Observar información de montaje
12Q	12Q	- ESP	para vehículos sin ESP
14,0	14,0	F	F
14Q	14Q	Fahrzeugproduktionsland	País producción vehículo
15,0	15,0	Felge Lochzahl	Llanta, nº de taladros
16Q	16Q	Felgengröße [Zoll]	Tamaño de llanta [pulgada]
18,0	18,0	Frankreich	Francia
2019	2019	für DAM-Nummer ab	para número DAM desde
20Q	20Q	→	
3	3	für erhöhte Nutzlast	para carga útil aumentada
4	4	für Facelift	para facelift
5	5	für Fahr-schulwagen	para coche de autoescuela
- ABS	para vehículos sin ABS		
ALU	Aluminio		
Aluguss	Fundición de aluminio		
Artikel-nummer des empfohlenen Zubehörs	Nº art. de accesorio recomendado		
- ASR	para vehículos sin ASR		



Technische Übersetzungen

Technical translations - Traducciones técnicas - Traductions techniques - Traduzioni tecniche

ES		ES	
für Fahrzeuge mit Adaptive Cruise Control	para vehículos con Adaptive Cruise Control	für Fahrzeuge mit Sportfahrwerk	para vehículos con chasis deportivo
für Fahrzeuge mit AMG-Sportpaket	para vehículos con paquete sport AMG	für Fahrzeuge mit Sportpaket	para vehículos con paquete sport
für Fahrzeuge mit autom. Distanzregelung	para vehículos con regulación automática de distancia	für Fahrzeuge mit Start-Stopp-Funktion	para vehículos con sistema Start&Stop
für Fahrzeuge mit Bremsassistent	para vehículos con asistencia a la frenada	für Fahrzeuge mit STC	para vehículos con STC
für Fahrzeuge mit elektr. Dämpferregulierung	para vehículos con regulación eléctrica de amortiguación	für Fahrzeuge mit Trommelbremse an der Hinterachse	para vehículos con freno de tambor en eje trasero
für Fahrzeuge mit elektronischer Fahrdynamikregelung	para vehículos con regulación dinámica de conducción	für Fahrzeuge mit Vakuumpumpe	para vehículos con bomba vacío
für Fahrzeuge mit Kollisionswarner	para vehículos con aviso de colisión	für Fahrzeuge mit verstärktem Fahrwerk	para vehículos con chasis reforzado
für Fahrzeuge mit M-Sportbremse	Para vehículos con frenos deportivos M	für Fahrzeuge mit verstärkter Bremse	para vehículos con freno reforzado
für Fahrzeuge mit Rußpartikelfilter	para vehículos con filtro de partículas	für Fahrzeuge ohne Adaptive Cruise Control	para vehículos sin Adaptive Cruise Control
für Fahrzeuge mit Scheibenbremse an der Hinterachse	para vehículos con freno de disco en eje trasero	für Fahrzeuge ohne Aktivlenkung	para vehículos sin dirección activo
für Fahrzeuge mit Servolenkung	para vehículos con dirección asistida	für Fahrzeuge ohne AMG-Sportpaket	para vehículos sin paquete deportivo AMG
		für Fahrzeuge ohne autom. Distanzregelung	para vehículos sin regulación automática de distancia

Technische Übersetzungen

Technical translations - Traducciones técnicas - Traductions techniques - Traduzioni tecniche

ES		ES	
für Fahrzeuge ohne Bremsassistent	Para vehículos sin asistencia a la frenada	für Modellreihenbaumuster	para el tipo de serie del modelo
für Fahrzeuge ohne elektronische Fahrdynamikregelung	para vehículos sin regulación dinámica de conducción	für OE-Nummer	para OE N°
für Fahrzeuge ohne Keramikbremse	para vehículos sin frenos de cerámica	für Rechtslenker	para vehíc. dirección a la derecha
für Fahrzeuge ohne Kollisionswarner	para vehículos sin aviso de colisión	für verkürzten Radstand	para distancia entre ejes acortada
für Fahrzeuge ohne M-Sportbremse	Para vehículos sin frenos deportivos M	für verlängerten Radstand	para distancia entre ejesprolongada
für Fahrzeuge ohne Servolenkung	para vehículos sin dirección asistida	Getriebeautomatik 6 Gang	Automático, 6 vel.
für Fahrzeuge ohne Sportfahrwerk	para vehículos sin chasis deportivo	Gewindemaß 1	Rosca 1
für Fahrzeuge ohne Sportpaket	para vehículos sin paquete sport	Gewindemaß 2	Rosca 2
für Fahrzeuge ohne Start-Stopp-Funktion	para vehículos sin sistema Start&Stop	GG	Pinza de frenos de hierro fundido
für Fahrzeuge ohne STC	para vehículos sin STC	Herstellereinschränkung	Restricción de fabricante
für Fahrzeuge ohne verstärktes Fahrwerk	para vehículos sin chasis reforzado	hyd.	hidráulico
für Kolbendurchmesser [mm]	para diám. pistón [mm]	Japan	Japón
für Linkslenker	para vehic. dirección izquierda	Kroatien	Croacia
		L=	Longitud [mm]
		L=	Longitud total [mm]
		L1=	Longitud 1 [mm]
		L2=	Longitud 2 [mm]
		lastabhängig	dependiente de la carga
		mit Bremsflüssigkeitsbehälter	con depósito líquido frenos
		mm Radnabendurchmesser [mm]	Diám. buje de rueda [mm]
		Motorcode	Código de motor
		nicht für Facelift	no para facelift
		nicht für Fahrschulwagen	no para veh. autoescuela







Technische Übersetzungen

Technical translations - Traducciones técnicas - Traductions techniques - Traduzioni tecniche

ES		ES	
nicht für Fahrzeuge mit verstärkter Bremse	no para vehículos con frenos reforzados	Schaltgetriebe	Caja de cambios manual
nicht für gepanzerte Fahrzeuge	no para vehículos blindados	Schaltgetriebe, automatisch betätigt	Caja de cambios manual, accionamiento automático
nicht für Schaltgetriebe sequentiell	no para caja de cambios manual secuencial	Schaltgetriebe 6 Gang	Caja de cambios manual, 6 marchas
nicht für Sonderfahrzeuge	no para veh. especiales	Schaltgetriebe sequentiell	Caja de cambios manual, secuencial
Nutzlast [kg]	Carga útil [kg]	Scheibenbremse	Discos
Nutzlast ab [kg]	carga útil desde [kg]	Schlüsselweite 1 [mm]	Ancho de llave 1 [mm]
Nutzlast bis [kg]	carga útil hasta [kg]	Schrägheck	Hatchback
Nutzlast-Code	Código de carga útil	Slowakische Republik	República eslovaca
Nutzlast leicht	Carga útil ligera	Sonderausstattungscode (SA-Code) ab →	Código de equipamiento especial a partir de
Nutzlast schwer	Carga útil pesada	Trommelbremse	Tambor
ohne Bremsflüssigkeitsbehälter	sin depósito líquido frenos	TRW	Sistema de frenos, Lucas / TRW
ohne Druckregler	sin regulador de presión	Tschechische Republik	República Checa
ohne Drucksensor	sin sensor de presión	Türenanzahl	Número de puertas
ohne Steuergerät	sin unidad de control	Ungarn	Hungría
Orga →	para número de OPR desde	x	Número de conexiones
- Performance Parts	para vehículos sin frenos alto rendimiento	Zubehör	Accesorios
pneumatisch	neumático	zusätzlich benötigter Artikel (Artikel-Nummer)	Se requiere adicionalmente artículo N°
Radstand [mm]	Distancia entre ejes [mm]	∅	Diámetro [mm]
Republik Korea (Südkorea)	Rep. Corea (Corea del Sur)	∅ "	Diámetro [pulgada]
- RU	Rusia	∅1	Diámetro 1 [mm]
Satz	Kit	∅2	Diámetro 2 [mm]
		→	año construcción desde N.º de chasis (VIN) desde
		→	año construcción hasta N.º de chasis (VIN) hasta

Technische Übersetzungen

Technical translations - Traducciones técnicas - Traductions techniques - Traduzioni tecniche

ES	FR
→ Modelljahr bis año modelo hasta	 Maître-cylindre de frein
→ Orga para número de OPR hasta	 Régulateur de freinage
→ Sonderausstattungscode (SA-Code) bis Código de equipamiento especial hasta	 Dispositif d'assistance de frein
	 gauche
	+ ABS pour véhicules avec système antiblo-cage
	+ ASR pour véhicules avec ASR
	+ DSC pour véhicules avec DSC
	+ DSTC pour véhicules avec DSTC
	+ EDS pour véhicules avec EDS
	+ ESP pour véhicules avec ESP
	+ Performance Parts pour véhicule avec frein Performance
	+PR pour numéro PR
	+ RO Roumanie
	+SA pour code d'équipement spécial
	+ TR Turquie
	12Q 12Q
	14,0 14,0
	14Q 14Q
	15,0 15,0
	16Q 16Q
	18,0 18,0
	2019 2019
	20Q 20Q
	3 3
	4 4
	5 5
	- ABS pour véhicules sans système antiblo-cage
	ALU Aluminium
	Aluguss Fonte d'aluminium
	Artikelnummer des empfohlenen Zubehörs Référence de l'accessoire recommandé

Technische Übersetzungen

Technical translations - Traducciones técnicas - Traductions techniques - Traduzioni tecniche

FR		FR	
- ASR	pour véhicules sans ASR	für Fahr- zeuge mit Adaptive Cruise Control	pour véhicule avec Adaptive Cruise Control
Ausstat- tungs-Code	Code d'équipement	für Fahr- zeuge mit AMG-Sport- paket	pour véhicules avec pack sport AMG
Automatikge- triebe	Boîte automatique	für Fahr- zeuge mit autom. Distanzrege- lung	pour véhicules avec régulation de distance autom.
BDX	Système de freinage, Bendix	für Fahr- zeuge mit elektr. Dämp- ferregulie- rung	pour véhicules avec assistant au freinage
Bördelform	Forme du bord relevé	für Fahr- zeuge mit elektron- ischer Fahr- dynamikrege- lung	p. véhicules avec régulat° électro. de dynamique de conduite
BOS	Système de freinage, Bosch	für Fahr- zeuge mit Kollisions- warner	pour véhicules avec système anti-collision
Bosnien- Herzegowina	Bosnie-Herzégovine	für Fahr- zeuge mit M- Sportbremse	pour véhicules avec système de freinage sport M
Bremskraft- verstärker	Servofrein	für Fahr- zeuge mit Rußpartikel- filter	pour véhicules avec filtre à particules
Brems- system	Système de freinage	für Fahr- zeuge mit Scheiben- bremse an der Hinter- achse	pour véhicules avec frein à disques à l'essieu arrière
CVT-Automa- tikgetriebe (stufenlos)	Boîte de vitesses automatique CVT (continue)	für Fahr- zeuge mit Servolen- kung	pour véhicules avec direction assistée
DEL	Système de freinage, Delco		
- Diff	sans blocage de différentiel		
- DSC	pour véhicules sans DSC		
- DSTC	pour véhicules sans DSTC		
E	E		
empty/leer	Attention au infos de montage!		
- ESP	pour véhicules sans ESP		
F	F		
Fahrzeugpro- duktionsland	Pays constructeur du véhicule		
Felge Loch- zahl	Jante, nombre de trous		
Felgengröße [Zoll]	Dimension de la jante [pouces]		
Frankreich	France		
für DAM- Nummer ab →	pour numéro DAM à partir de		
für erhöhte Nutzlast	pour charge utile surélevée		
für Facelift	pour facelift		
für Fahr- schulwagen	pour véhicules d'auto-école		

Technische Übersetzungen

Technical translations - Traducciones técnicas - Traductions techniques - Traduzioni tecniche

FR		FR	
für Fahrzeuge mit Sportfahrwerk	pour véhicules avec châssis sportif	für Fahrzeuge ohne Bremsassistent	pour véhicules sans assistant de freinage
für Fahrzeuge mit Sportpaket	pour véhicules avec équipement sport	für Fahrzeuge ohne elektronische Fahrdynamikregelung	pr véhicules sans régulation électr. dynamique de conduite
für Fahrzeuge mit Start-Stopp-Funktion	pour véhicules avec fonction Stop/Start	für Fahrzeuge ohne Keramikbremse	pour véhicules sans frein en céramique
für Fahrzeuge mit STC	pour véhicules avec STC	für Fahrzeuge ohne Kollisionswarner	pour véhicules sans système anti-collision
für Fahrzeuge mit Trommelbremse an der Hinterachse	pour véhicules avec frein à tambour à l'essieu arrière	für Fahrzeuge ohne M-Sportbremse	pour véhicules sans système de freinage sport M
für Fahrzeuge mit Vakuumpumpe	pour véhicules avec pompe à vide	für Fahrzeuge ohne Servolenkung	pour véhicules sans direction assistée
für Fahrzeuge mit verstärktem Fahrwerk	pour véhicules avec châssis renforcé	für Fahrzeuge ohne Sportfahrwerk	pour véhicules sans châssis sportif
für Fahrzeuge mit verstärkter Bremse	pour véhicules avec frein assisté	für Fahrzeuge ohne Sportpaket	pour véhicules sans équipement sport
für Fahrzeuge ohne Adaptive Cruise Control	pour véhicule sans Adaptive Cruise Control	für Fahrzeuge ohne Start-Stopp-Funktion	pour véhicules sans fonction Stop/Start
für Fahrzeuge ohne Aktivlenkung	pour véhicules sans direction active	für Fahrzeuge ohne STC	pour véhicules sans STC
für Fahrzeuge ohne AMG-Sportpaket	pour véhicules sans pack sport AMG	für Fahrzeuge ohne verstärktes Fahrwerk	pour véhicules sans châssis renforcé
für Fahrzeuge ohne autom. Distanzregelung	pour véhicules sans régulation de distance autom.	für Kolbendurchmesser [mm]	pour diamètre de piston [mm]
		für Linkslenker	pour véhicules avec direction à gauche



Technische Übersetzungen

Technical translations - Traducciones técnicas - Traductions techniques - Traduzioni tecniche

FR	FR
für Modellreihenbaumuster pour le modèle de la série de modèles	nicht für Fahrzeuge mit verstärkter Bremse pas pour véhicules avec frein assisté
für OE-Nummer pour numéro OE	nicht für gepanzerte Fahrzeuge pas pour véhicules blindés
für Rechtslenker pour véhicules avec direction à droite	nicht für Schaltgetriebe sequentiell pas pour boîte de vitesse séquentielle
für verkürzten Radstand pour empattement raccourci	nicht für Sonderfahrzeuge pas pour véhicules spéciaux
für verlängerten Radstand pour empattement rallongé	Nutzlast [kg] Charge utile [kg]
Getriebeautomatik 6 Gang Boîte automatique à 6 vitesses	Nutzlast ab [kg] Charge utile à partir de [kg]
Gewindemaß 1 Taraudage/Filetage 1	Nutzlast bis [kg] Charge utile jusqu'à [kg]
Gewindemaß 2 Taraudage/Filetage 2	Nutzlast-Code Code de charge utile
GG Étrier de frein en fonte	Nutzlast leicht Charge utile légère
Herstellereinschränkung Montage d'origine	Nutzlast schwer Charge utile lourde
hyd. hydraulique	ohne Bremsflüssigkeitsbehälter sans réservoir du liquide de frein
Japan Japon	ohne Druckregler sans régulateur de pression
Kroatien Croatie	ohne Drucksensor sans capteur de pression
L= Longueur [mm]	ohne Steuergerät sans appareil de commande
L= Longueur globale [mm]	Orga → pour n° OPR(date de fabrication du véhicule) à partir de
L1= Longueur 1 [mm]	- Performance Parts pour véhicules sans frein Performance
L2= Longueur 2 [mm]	pneumatisch pneumatique
lastabhängig Fonction de la charge	Radstand [mm] Empattement [mm]
mit Bremsflüssigkeitsbehälter avec filtre déshydratant pour liquide de freins	Republik Korea (Südkorea) République de Corée (Corée du Sud)
mm Radnabendurchmesser [mm] Diamètre moyeu de roue [mm]	- RU Russie
Motorcode Code moteur	
nicht für Facelift pas pour facelift	
nicht für Fahrschulwagen pas pour véhicules d'auto-école	

Technische Übersetzungen





Technical translations - Traducciones tecnicas - Traductions techniques - Traduzioni tecniche

FR		FR	
Satz	Jeu	→	Année jusqu'à Numéro de châssis (VIN) à
Schaltge- triebe	boîte de vitesses manuelle	→ Modelljahr bis	Année jusqu'à
Schaltge- triebe, auto- matisch betä- tigt	Boîte de vitesses mécanique à commande automatisée	→ Orga	pour numéro OPR jusqu'à
Schaltge- triebe 6 Gang	Boîte de vitesses manuelle à 6 vitesses	→ Sonder- ausstat- tungscode (SA-Code) bis	Code d'équipement spécial jusqu'à
Schaltge- triebe sequentiell	Boîte de vitesses séquentiel		
Scheiben- bremse	Frein à disque		
Schlüssel- weite 1 [mm]	Largeur de clé 1 [mm]		
Schrägheck	Berline bicorps trois ou cinq portes		
Slowakische Republik	République slovaque		
Sonderaus- stattungscode (SA-Code) ab →	Code d'équipement spécial à partir de		
Trommel- bremse	Frein à tambour		
TRW	Système de freinage, Lucas / TRW		
Tschechi- sche Republik	République tchèque		
Türenanzahl	Nombre de portes		
Ungarn	Hongrie		
x	Nombre de connexions		
Zubehör	Accessoires		
zusätzlich benötigter Artikel (Artikel- Nummer)	article supplémentaire (référence)		
Ø	Diamètre [mm]		
Ø "	Diamètre [pouces]		
Ø1	Diamètre 1 [mm]		
Ø2	Diamètre 2[mm]		
→	Année à partir de Numéro de châssis (VIN) à partir de		



Technische Übersetzungen

Technical translations - Traducciones técnicas - Traductions techniques - Traduzioni tecniche

IT		IT	
	Cilindro maestro del freno	Ausstattungs-Code	Codice dotazione
	Modulatore frenata	Automatikgetriebe	Trasmissione automatica
	Servofreno	BDX	Sistema frenante, Bendix
	Sx	Bördelform	Forma bordatura
+ ABS	per veicoli con ABS	BOS	Sistema frenante, Bosch
+ ASR	per veicoli con ASR	Bosnien-Herzegowina	Bosnia ed Erzegovina
+ DSC	per veicoli con DSC	Bremskraftverstärker	Servofreno
+ DSTC	per veicoli con DSTC	Brems-system	Sistema frenante
+ EDS	per veicoli con EDS	CVT-Automatikgetriebe (stufenlos)	Cambio automatico CVT (continuo)
+ ESP	per veicoli con ESP	DEL	Sistema frenante, Delco
+ Performance Parts	per veicoli con freno Performance	- Diff	senza blocco differenziale
+PR	per N° PR	- DSC	per veicoli senza DSC
+ RO	Romania	- DSTC	per veicoli senza DSTC
+SA	per codice modello speciale	E	E
+ TR	Turchia	empty/leer	Osservare info montaggio
12Q	12Q	- ESP	per veicoli senza ESP
14,0	14,0	F	F
14Q	14Q	Fahrzeugproduktionsland	Paese produzione veicolo
15,0	15,0	Felge Lochzahl	Cerchione, N° fori
16Q	16Q	Felgengröße [Zoll]	Misura cerchione [pollici]
18,0	18,0	Frankreich	Francia
2019	2019	für DAM-Nummer ab	per numero DAM da
20Q	20Q	→	
3	3	für erhöhte Nutzlast	per elevata portata utile
4	4	für Facelift	per Facelift
5	5	für Fahr-schulwagen	per vettura per scuola guida
- ABS	per veicoli senza ABS		
ALU	Alluminio		
Aluguss	Alluminio pressofuso		
Artikel-nummer des empfohlenen Zubehörs	N° articolo accessorio consigliato		
- ASR	per veicoli senza ASR		

Technische Übersetzungen

Technical translations - Traducciones técnicas - Traductions techniques - Traduzioni tecniche

IT		IT	
für Fahrzeuge mit Adaptive Cruise Control	per veicoli con Adaptive Cruise Control	für Fahrzeuge mit Sportfahrwerk	per veicoli con autotelaio sportivo
für Fahrzeuge mit AMG-Sportpaket	per veicoli con pacchetto sportivo AMG	für Fahrzeuge mit Sportpaket	per veicoli con pacchetto sportivo
für Fahrzeuge mit autom. Distanzregelung	per veicoli con regolatore automatico distanza	für Fahrzeuge mit Start-Stopp-Funktion	per veicoli con funzione di start-stop
für Fahrzeuge mit Bremsassistent	per veicoli con brake assist	für Fahrzeuge mit STC	per veicoli con STC
für Fahrzeuge mit elektr. Dämpferregulierung	per veicoli con regolazione elettr. ammortizzatori	für Fahrzeuge mit Trommelbremse an der Hinterachse	per veicoli con freni a tamburo ad assale posteriore
für Fahrzeuge mit elektronischer Fahrdynamikregelung	per veicoli con regolazione elettronica dinamica di guida	für Fahrzeuge mit Vakuumpumpe	per veicoli con pompa a depressione
für Fahrzeuge mit Kollisionswarner	per veicoli con segnale anticollisione	für Fahrzeuge mit verstärktem Fahrwerk	per veicoli con autotelaio rinforzato
für Fahrzeuge mit M-Sportbremse	per veicoli con freni sportivi M	für Fahrzeuge mit verstärkter Bremse	per veicoli con freno rinforzato
für Fahrzeuge mit Rußpartikelfilter	per veicoli con filtro antiparticolato	für Fahrzeuge ohne Adaptive Cruise Control	per veicoli senza Adaptive Cruise Control
für Fahrzeuge mit Scheibenbremse an der Hinterachse	per veicoli con freni a disco ad assale posteriore	für Fahrzeuge ohne Aktivlenkung	per veicoli senza meccanismo sterzo attivo
für Fahrzeuge mit Servolenkung	per veicoli con servosterzo	für Fahrzeuge ohne AMG-Sportpaket	per veicoli senza pacchetto sportivo AMG
		für Fahrzeuge ohne autom. Distanzregelung	per veicoli senza regolatore automatico distanza



Technische Übersetzungen

Technical translations - Traducciones técnicas - Traductions techniques - Traduzioni tecniche

IT	IT
für Fahrzeuge ohne Bremsassistent per veicoli senza brake assist	für Modellreihenbaumuster per la serie di modelli
für Fahrzeuge ohne elektronische Fahrdynamikregelung per veicoli senza regolazione elettronica dinamica guida	für OE-Nummer per N° OE
für Fahrzeuge ohne Keramikbremse per veicoli senza freni in ceramica	für Rechtslenker per veicolo con guida a Dx
für Fahrzeuge ohne Kollisionswarner per veicoli senza segnale anticollisione	für verkürzten Radstand per passo route accorciato
für Fahrzeuge ohne M-Sportbremse per veicoli senza freni sportivi M	für verlängerten Radstand per passo route allungato
für Fahrzeuge ohne Servolenkung per veicoli senza servosterzo	Getriebeautomatik 6 Gang Cambio automatico a 6 marce
für Fahrzeuge ohne Sportfahrwerk per veicoli senza autotelaio sportivo	Gewindemaß 1 Dimensioni filettatura 1
für Fahrzeuge ohne Sportpaket per veicoli senza pacchetto sportivo	Gewindemaß 2 Dimensioni filettatura 2
für Fahrzeuge ohne Start-Stopp-Funktion per veicoli senza funzione di start-stop	GG Pinza freno in ghisa
für Fahrzeuge ohne STC per veicoli senza STC	Herstellereinschränkung Limitazione costruttore
für Fahrzeuge ohne verstärktes Fahrwerk per veicoli senza autotelaio rinforzato	hyd. idraulico
für Kolbendurchmesser [mm] per diametro pistone [mm]	Japan Giappone
für Linkslenker per veicolo con guida a Sx	Kroatien Croazia
	L= Lunghezza [mm]
	L= Lunghezza totale [mm]
	L1= Lunghezza 1 [mm]
	L2= Lunghezza 2 [mm]
	lastabhängig subordinato al carico
	mit Bremsflüssigkeitsbehälter con serbatoio liquido freni
	mm Radnabendurchmesser [mm] Diametro mozzo ruota [mm]
	Motorcode Codice motore
	nicht für Facelift non per Facelift
	nicht für Fahrschulwagen Non per vettura per scuola guida

Technische Übersetzungen

Technical translations - Traducciones técnicas - Traductions techniques - Traduzioni tecniche

IT		IT	
nicht für Fahrzeuge mit verstärkter Bremse	Non per veicoli con freno rinforzato	Schaltgetriebe	Cambio manuale
nicht für gepanzerte Fahrzeuge	Non per veicoli corazzati	Schaltgetriebe, automatisch betätigt	Cambio manuale, azionamento automatico
nicht für Schaltgetriebe sequentiell	non per cambio manuale sequenziale	Schaltgetriebe 6 Gang	Cambio manuale a 6 marce
nicht für Sonderfahrzeuge	Non per veicoli speciali	Schaltgetriebe sequentiell	Cambio manuale sequenziale
Nutzlast [kg]	Portata utile [kg]	Scheibenbremse	Freno a disco
Nutzlast ab [kg]	Portata utile da [kg]	Schlüsselweite 1 [mm]	Apertura chiave 1 [mm]
Nutzlast bis [kg]	Portata utile fino a [kg]	Schrägheck	Hatchback
Nutzlast-Code	Codice portata utile	Slowakische Republik	Repubblica slovacca
Nutzlast leicht	Portata utile leggera	Sonderausstattungscode (SA-Code) ab →	Codice modello speciale a partire da →
Nutzlast schwer	Portata utile pesante	Trommelbremse	Freno a tamburo
ohne Bremsflüssigkeitsbehälter	senza serbatoio liquido freni	TRW	Sistema frenante, Lucas / TRW
ohne Druckregler	senza regolatore pressione	Tschechische Republik	Repubblica ceca
ohne Drucksensor	senza sensore pressione	Türenanzahl	N° portiere
ohne Steuergerät	senza centralina	Ungarn	Ungheria
Orga →	per numero organizzazione da	x	N° raccordi
- Performance Parts	per veicoli senza freno Performance	Zubehör	Accessori
pneumatisch	pneumatico	zusätzlich benötigter Artikel (Artikel-Nummer)	Articolo supplementare occorrente (N° articolo)
Radstand [mm]	Passo ruote [mm]	∅	Diametro [mm]
Republik Korea (Südkorea)	Repubblica di Corea (Corea del Sud)	∅ "	Diametro [pollici]
- RU	Russia	∅1	Diametro 1 [mm]
Satz	Serie / Kit	∅2	Diametro 2 [mm]
		→	Anno da N° telaio (VIN) da
		→	Anno fino a N° telaio (VIN) fino a

Technische Übersetzungen

Technical translations - Traducciones tecnicas - Traductions techniques - Traduzioni tecniche

IT

→ Modelljahr bis	Anno modello fino a
→ Orga	per numero organizzazione fino a
→ Sonderausstattungscode (SA-Code) bis	Codice modello speciale fino a

**Continental Aftermarket &
Services GmbH**

Sodener Straße 9
D-65824 Schwalbach
Tel. +49 (0) 6196 87 0
www.ate.de

**Continental Automotive Trading
Italia S.r.l.**

Via Matteotti, 62
I-20092 Cinisello Balsamo (MI)
Tel. +39 02 35680 1
www.ate-freni.it

**Continental Automotive Trading
France**

6 rue Jean Moulin
F-78120 Rambouillet
Tél. +33 (0) 9 69 37 37 37
www.ate-freinage.fr

**Continental Automotive Spain,
S.A.**

C/ Sepúlveda, 11
E-28108 Alcobendas (Madrid)
Tel. +34 91 657 21 21
www.frenos-ate.es